

SMART FOCUS

Active infrared safety sensor for automatic doors



Visit website for available languages of this document.

DESCRIPTION

1. LED
2. emitter
3. DIP switch
4. push button
5. setup adjustment screw
6. mounting screw
7. receiver
8. cable with connector
9. face

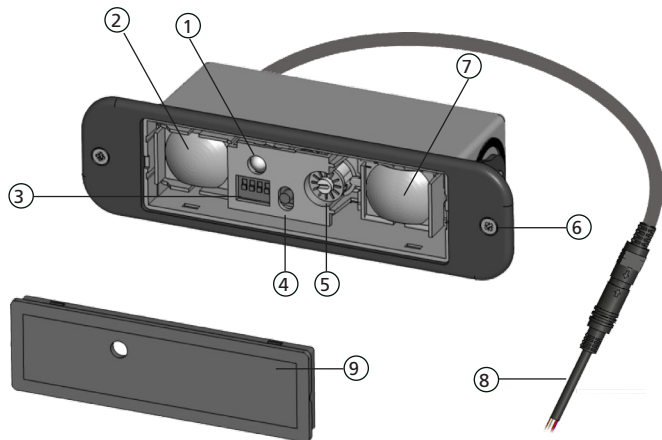

TECHNICAL SPECIFICATIONS

Technology	active infrared
Detection mode	presence detection by distance measurement
Detection field	1 3/4" x 2 3/4" (at 7' mounting height)
Response time	64 ms
Mounting height	2 – 10'
Supply voltage	12 – 24 VAC/VDC -5% / +10%
Mains frequency	50 – 60 Hz
Max. current consumption	120mA @ 24 VAC / 80mA @ 24 VDC
Standard output: max. contact voltage max. contact current max. switching power	relay (free of potential contact) 42 VAC/VDC 1A (resistive) 30W (DC) / 42 VA (AC)
Monitoring input: max. contact voltage voltage threshold	1 optocoupler (free of potential contact) 30 V high state: > 10 V low state: < 1 V
Hold time	0.5 s
Reflectivity	min. 10% at IR-wavelength of 850nm
Temperature range	-13 – 131 °F (-25 – 55 °C) 0 – 95% rel. humidity, non-condensing
Degree of protection	IP53
Dimensions	5 3/4" (L) x 1 3/5" (H) x 2" (D)
Housing material	ABS (black)
Cable length (main cable)	8'
Norm conformity	IEC 61000-6-2; IEC 61000-6-3; ISO 13849-1 Performance Level «C» CAT. 2 (under the condition that the door control system monitors the sensor at least once per door cycle)

*Specifications are subject to change without prior notice.
All values measured in specific conditions.*

INSTALLATION



- Avoid reflective background or objects in the detection field of the sensor.
- Avoid high intensity lighting in the detection field.
- Do not cover the sensor.
- Do not touch the optical parts.

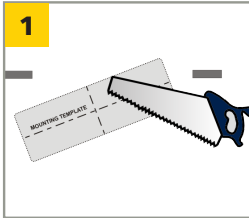

Using the mounting template, cut an opening in the desired location for the sensor.

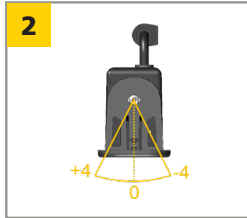

Loosen the mounting screws and manually adjust the sensor angle. Be sure to tighten the screws when finished.

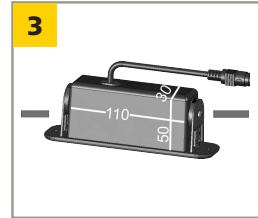

Connect the cables and insert the sensor in the opening from step 1.

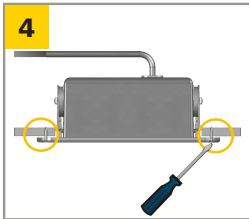

Once inserted, secure the 2 mounting screws.

5

— BLACK	} POWER SUPPLY (12 – 24 VAC/VDC)
— RED	
— WHITE	} COM
— GREEN	
— YELLOW	
— PURPLE/YELLOW	} MONITORING
— PURPLE	

	N.O. WHITE/YELLOW	N.C. WHITE/GREEN
NO POWER		
DETECTION		
NO DETECTION		

Wire the sensor according to the diagram.

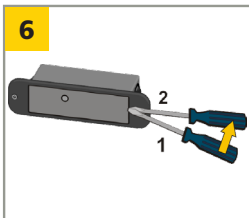

Remove the face by inserting a screwdriver as shown.



Press the push button to launch an automatic setup. *The LED will flash red/green.*



When the LED is no longer flashing, the sensor is set up. Now secure the face and test for proper operation.

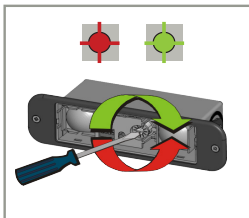

If the LED continues to flash, the sensor must be adjusted (see next page).

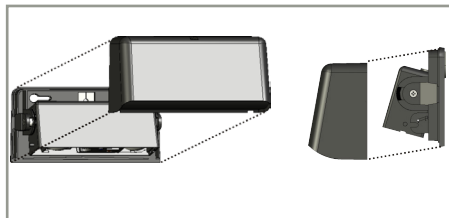

The sensor can also be installed on the surface by using the surface mount accessory (sold separately).

ADDITIONAL DIP SWITCH ADJUSTMENTS



DIP SWITCH OFF (factory values)

DIP SWITCH ON

DIP 1

AUTOMATIC MODE

MANUAL MODE

SETUP

1. Verify that the adjustment screw is positioned as shown (right). Make no adjustments at this time.

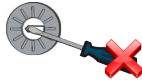

2. Press the push button to launch an automatic setup. The LED will flash red/green.

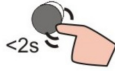

3. Switch to manual mode (set DIP 1 to ON) and follow steps to the right.

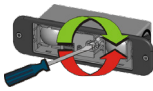

Use MANUAL mode in any of the following conditions:

- low reflectivity of background
- no background or mounting height > 10 ft
- mounting height < 5.25 ft
- uncovered zone > 1.3 ft

1. Turn the adjustment screw to to change the uncovered zone.

increase = counterclockwise
decrease = clockwise

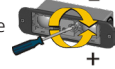

2. Decrease (-) or increase (+) the uncovered zone and check it by moving a white paper up and down under the sensor.

Do not move the paper horizontally.

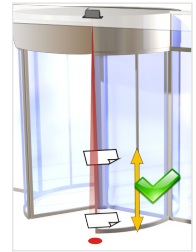

DIP 2

SMALL (10" at 7' high)

BIG (15 3/4" at 7' high)

UNCOVERED ZONE

Use SMALL in any of the following conditions:

- increased door safety is required

Relaunch a setup after changing DIP 2.

Use BIG in any of the following conditions:

- increased immunity to disturbances is required

Relaunch a setup after changing DIP 2.

DIP 3

FREQUENCY 1

FREQUENCY 2

FREQUENCY

Use F1 in any of the following conditions:

- 2+ sensors installed in proximity to each other



Use F2 in any of the following conditions:

- 2+ sensors installed in proximity to each other



DIP 4

ACTIVE HIGH

ACTIVE LOW

MONITORING

Use F1 in any of the following conditions:









- monitoring input = active high
- no monitoring required

Use F2 in any of the following conditions:

- monitoring input = active low

When finished, confirm DIP changes with a long push of the push button.

TROUBLESHOOTING

	The RED LED is ON sporadically or permanently.	Bad calibration.	Launch a calibration.
		Bad adjustment of the uncovered zone.	Check if the DIP 4 is in correct position. Launch a calibration.
		The sensor is disturbed by external light sources or another sensor.	Select a different frequency for each module (DIP 2). Launch a calibration.
	The sensor does not react, but a calibration can be launched.	The monitoring is activated, but the monitoring input is not powered.	Check wiring. <ul style="list-style-type: none"> Door control <u>with monitoring</u>: Connect purple and purple/yellow wires to monitoring output of door control. Door control <u>without monitoring</u>: Set DIP switch 4 to OFF.
		The monitoring mode is incorrect.	Change position of DIP 4.
	The ORANGE LED is on permanently.	The sensor encounters a memory problem.	Replace sensor.
	The ORANGE LED flashes quickly.	DIP switch setting awaiting confirmation.	Confirm the DIP switch setting with a long push on the push button.
	The ORANGE LED flashes 1x every 3 seconds.	The sensor signals an internal fault.	Cycle power supply. If orange LED flashes again, replace sensor.
	The ORANGE LED flashes 2x every 3 seconds.	Power supply is out spec range (12 – 24 VAC/VDC -5% / +10%).	Check power supply. Reduce the cable length or change cable.
	The ORANGE LED flashes 4x every 3 seconds.	The sensor does not receive enough IR-energy.	Launch a new calibration. Step out of the detection field. Change angle of spots. Switch off background (DIP 1: ON).
	The ORANGE LED flashes 5x every 3 seconds.	Calibration error.	Check mounting height. Change position of setup adjustment screw. Launch a new calibration. Switch off background (DIP 1: ON).

BEA, INC. INSTALLATION/SERVICE COMPLIANCE EXPECTATIONS

BEA, Inc., the sensor manufacturer, cannot be held responsible for incorrect installations or incorrect adjustments of the sensor/device; therefore, BEA, Inc. does not guarantee any use of the sensor/device outside of its intended purpose.

BEA, Inc. strongly recommends that installation and service technicians be AAADM-certified for pedestrian doors, IDA-certified for doors/gates, and factory-trained for the type of door/gate system.

Installers and service personnel are responsible for executing a risk assessment following each installation/service performed, ensuring that the sensor/device system performance is compliant with local, national, and international regulations, codes, and standards.

Once installation or service work is complete, a safety inspection of the door/gate shall be performed per the door/gate manufacturer's recommendations and/or per AAADM/ANSI/DASMA guidelines (where applicable) for best industry practices. Safety inspections must be performed during each service call – examples of these safety inspections can be found on an AAADM safety information label (e.g. ANSI/DASMA 102, ANSI/DASMA 107, UL294, UL325, and International Building Code).

Verify that all appropriate industry signage, warning labels, and placards are in place.



Tech Support & Customer Service: 1-800-523-2462
General Tech Questions: techservices-us@BEAsensors.com | Tech Docs: www.BEAsensors.com