

Installation Instructions

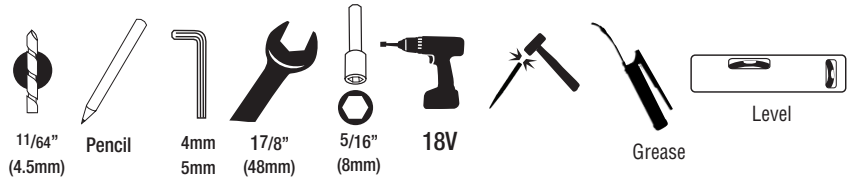

SureClose **ReadyFit**

Model	Hinge Type	SF for Pool Gates	Hold Open Feature	Load Bearing
74001313	RF SM S			✓
74001315	RF SM W			✓
74108313	RF 108 S		✓	
74108315	RF 108 W		✓	
74108323	RF 108SF S	✓		
74108325	RF 108SF W	✓		



GATE GAP VARIANCE: 1/2" - 13/8" (12-35mm)

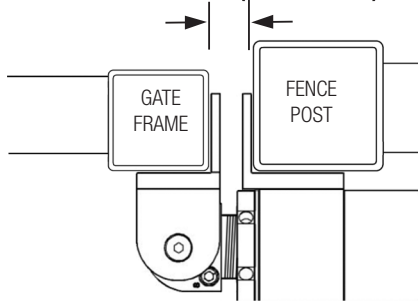

1 DETERMINE LEFT OR RIGHT HANDED ADJUSTMENT NOZZLES MUST BE POINTED UPWARD

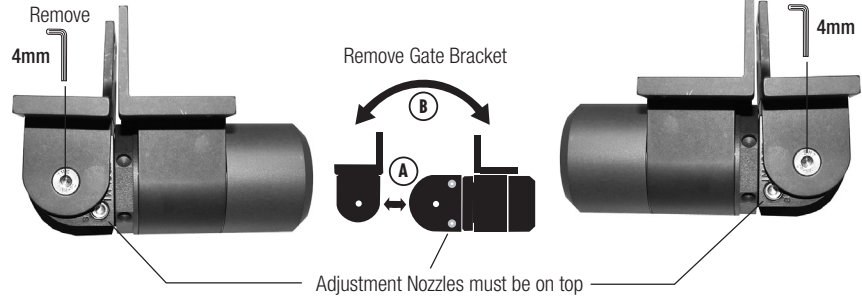

2 VERIFY MODEL (*see page 2) APPLY GREASE AND RETURN TO REQUIRED GATE GAP

3 ENSURE GATE IS LEVEL

Support Blocks

For Swimming Pool Gates in AU/NZ (see Page 2)

WELDING

Remove hinge from mounting brackets before welding to avoid damage. Use general field welding operations with suitable heat transfer controls. See **CAUTION** advice on next page.

GATE STOP

A gate stop must be installed when using SF models. Gate must not be allowed to open past 90°. Doing so voids warranty.

4 FASTEN SCREWS INTO SLOTS ON TOP AND BOTTOM HINGE

5 OPEN GATE AND FASTEN SCREWS 5 AND 6

6 DETERMINE PROPER VERTICAL ALIGNMENT AND FASTEN SCREWS FIRMLY

7 INSTALL THE REST OF THE FASTENERS IN TOP AND BOTTOM HINGES ON FACE AND SIDE LEGS

8 HORIZONTAL ADJUSTMENT

Use adjustment tool included or wrench to adjust horizontally.

ADJUSTING THE CLOSING SPEED AND FINAL 'SNAP' ACTION

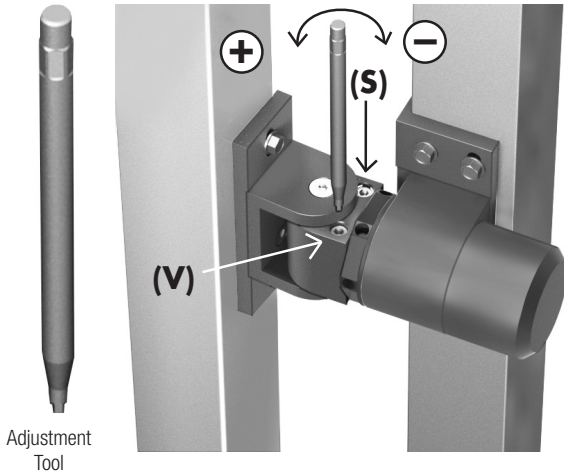

CAUTION: Sensitive adjustment, rotate 1/4 turn at a time.

V = Closing Speed

S = Final Snap Action

Turn nozzles clockwise to decrease speed & counter-clockwise to increase speed.

If using two closers in combination, each closer must have equal closing speed at all times.



IMPORTANT:

Use dimple to determine how far nozzle has turned.

DO NOT turn adjustment nozzles more than 2 complete rotations.

DO NOT unscrew nozzle past the surface of the body.

CAUTION:

DO NOT remove adjustment nozzles or disassemble hinge. Doing so voids warranty.

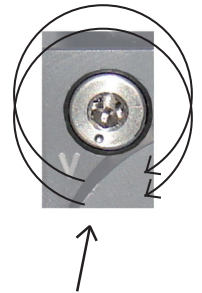

D[®] SUREClose[®] READYFit



Gate stop must be installed when using SF models. Gate must not be allowed to open past 90°.

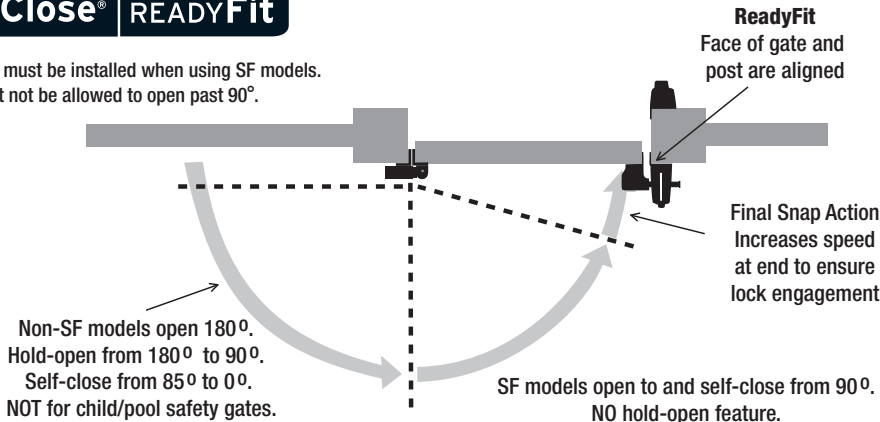

Non-SF models open 180°. Hold-open from 180° to 90°. Self-close from 85° to 0°. NOT for child/pool safety gates.

SF models open to and self-close from 90°. NO hold-open feature. Suitable for child/pool safety gates. DO NOT PROP GATE OPEN.

* SF models have 5 dimples. Remove from bracket to verify before installation.



MAINTENANCE REQUIREMENTS

- A gate stop must be installed when using SF models. Gate must not be allowed to open past 90°. Doing so voids warranty.
- Never use more than two (2) SureClose hinge/closers on any one gate.
- Remove all other types of hinges and self-closing devices.
- Always install SM hinge at bottom of gate and 57/108 closer on top.
- Ensure the gate does not swing through the line of the fence. Use a "gate stop" or a latch (with striker) to prevent this.
- All steel mounting brackets (gate and post) should be painted or powder coated. Spray painting is recommended.
- The anodized aluminum mounting brackets do not need finishing, but they may be painted or powder coated.
- DO NOT powder coat the hinge/closer, but they may be painted.
- DO NOT turn the adjustment nozzles more than two (2) full rotations.
- DO NOT unscrew nozzle past the surface of the body.
- DO NOT remove the adjustment nozzles or disassemble these hinges at any time. Doing so voids warranty.
- Ensure the hinges are kept free of sand, ice and other debris that could impair effective operation.



D&D Technologies
Hi-Performance Hardware

Swimming Pool Gates AU/NZ

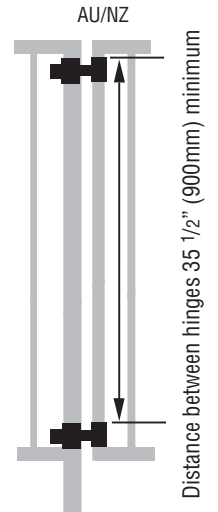

*CAUTION: When used on swimming pool gates, always consult local authorities for swimming pool Codes.



WELDING

CAUTION: Remove hinge from mounting brackets before welding to avoid damage. Overheating any SureClose product during welding may cause failure and will void warranty. Clean up and finish with appropriate corrosion protection, avoiding thread contamination.