



Model 500A / 500B Series (4LR50RT200A3D2-BY) Vehicular Swing Gate Operator



Installation and Operators Manual

Specifications:

Motor:	1/6 Horsepower
Hydraulic Pump:	Spur Gear
Power Supply:	115-Volt / 220-Volt
Amp Draw:	4 Amps
Temperature Range:	-40°F to 240°F
Operator Length (with piston retracted and rear bracket and swivel installed)	22.72 Inches
Operator Length (extended with rear bracket and swivel joint installed)	35.59 Inches
Piston Travel	7.9 Inches (200mm)
Width / Height Maximum	4.33 Inches
Maximum Speed for 0 to 90 Degrees	Approximately 12 Seconds
Maximum Degree of Gate Opening	90 Degrees
Maximum Length of Gate	12 Feet
Maximum Weight of Gate Leaf	1500 Pounds
Duty Cycle (Open / Close)	40 Cycles Per Hour

307.334.2865

Fax 307.334.2028

P.O. Box 1384 | 413 South Linden Street | Lusk, Wyoming 82225

www.byan.com

Toll Free 800.223.2926



IMPORTANT INFORMATION

WHEN INSTALLING YOUR BYAN OPERATOR, **ALWAYS** INSTALL THE OPERATOR WITH THE GATE LEAF IN THE **CLOSED** POSITION.

If your gate has an **INWARD** swing:

Locate the rear mounting bracket on the gate post. After making sure of your “A” and “B” dimensions, connect the operator to the power supply and extend the piston fully, making sure to use the power supply. Attach the swivel joint and locknut to the piston; **SCREW IT IN HALF OF THE WAY ONLY**.

With the gate leaf in the **CLOSED** position, place the operator on the rear mounting bracket and in this manner, locate the position of the front mounting bracket. The “C” dimension for the front mounting bracket should be taken from the **FACE** of the gate leaf.

If your gate has an **OUTWARD** swing:

Follow the procedure above, making sure that the piston is in the fully **RETRACTED** position.

THE MODEL 500 OPERATORS USE A FRONT MOUNTING BRACKET WITH A SHOULDER OF APPROXIMATELY 5/8-INCH. **THIS MEANS** THAT WHEN YOU LOCATE THIS BRACKET ON THE GATE LEAF, YOU **MUST** WELD IT APPROXIMATELY 5/8-INCH **LOWER** THAN THE REAR MOUNTING BRACKET ON THE GATE POST.

THE OPERATING PRESSURES ON YOUR OPERATOR HAVE BEEN FACTORY-SET. IF YOU NEED TO ALTER THESE PRESSURES, **PLEASE CONTACT BYAN SYSTEMS AT (800) 223-2926 OR (307) 334-2865 BEFORE MAKING ANY CHANGES.**

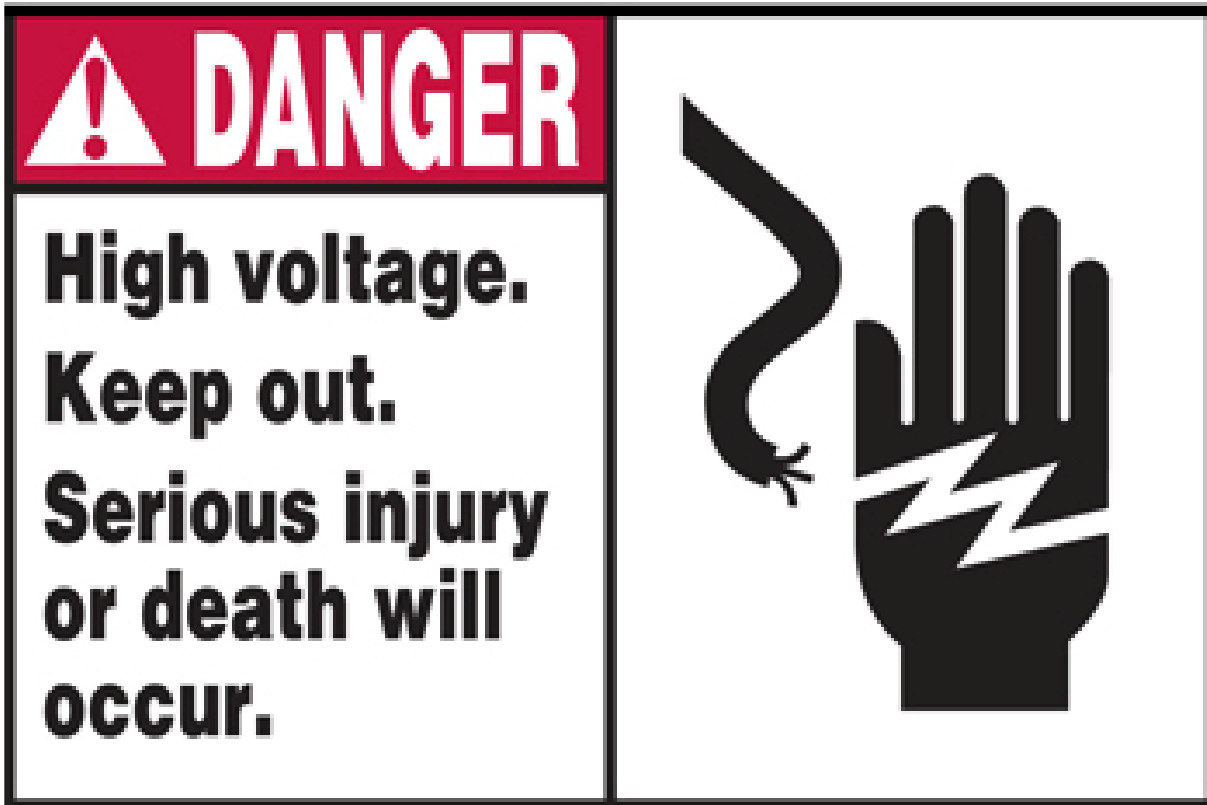

THIS EQUIPMENT USES HIGH VOLTAGE. TO REDUCE THE RISK OF SEVERE INJURY OR DEATH, FOLLOW ALL INSTALLATION INSTRUCTIONS.

THIS SYSTEM SHOULD ONLY BE INSTALLED AND/OR MODIFIED BY QUALIFIED TECHNICAL PERSONNEL.

ALL INSTALLERS, REGARDLESS OF EXPERIENCE, SHOULD REVIEW PAGES 6 THROUGH 11 BEFORE INSTALLING THIS ACTUATOR.

As a Byan Systems gate installer, you **MUST** inform your customer about all safety equipment that should be installed on each job site. This is in accordance with your legal liability to your customer. Ensure that the protection and warning signaling devices are operational and visible. These steps will aid in your defense should you become involved in litigation regarding injury or damage.

IMPORTANT INSTALLATION INSTRUCTIONS

WARNINGS

To reduce the risk of severe injury or death:

READ AND FOLLOW ALL INSTALLATION INSTRUCTIONS

Install the operator only on a properly operating and balanced gate. A gate that is operating improperly could cause severe injury. Have qualified service personnel make repairs to cables, spring assemblies and other hardware before installing the operator.

Remove, or make inoperative, all locks (unless mechanically and/or electrically interlocked to the power unit) connected to the gate before installing the operator.

Do not connect the gate operator to the source of power until instructed to do so.

Locate the control station within sight of the gate.

Install the Entrapment Warning Placard next to the control station in a prominent location.

IF THERE IS AN OBJECT WITHIN 18" OF THE FULLY OPEN GATE, THERE MUST BE ANOTHER SAFETY DEVICE APPROPRIATELY LOCATED AND INSTALLED TO PREVENT ENTRAPMENT BETWEEN THE OBJECT AND THE GATE.

Table of Contents

Usage Classes for Vehicular Gates	Page 7
Technical Data	Page 8
Pre-Installation Recommendations	Page 9
Installation Procedures	Page 10
Installation Completion / Follow-up	Page 12
Pressure Adjustments	Page 13
Purging the Operator	Page 13
Hydraulic Fluid	Page 13
Manual Bypass	Page 14
Pressure & Flow Control	Page 15
Mounting Pins & Brackets	Page 15
Optional Mounting Hardware	Page 16
Front Mounting Detail	Page 17
Mounting Geometry	Page 18
Mounting Bracket Dimensions	Page 19
Recommended Wire Sizes	Page 20
Wiring the Control and Accessories	Page 21
Loop Detector Connections	Page 47
Recommended Placement of Safety Edges and Photobeams	Page 48
End User Safety	Page 49
WARNING PLACARD	Page 51
Byan Systems Warranty	Page 52
Safety Accessories Compatible and Tested with Byan Systems Products	Page 53
Customer Acknowledgement	Page 55

USAGE CLASSES FOR VEHICULAR GATES

Class I – Residential Vehicular Gate Operator

A vehicular gate operator (or system) intended for use in a home of one to four single family dwelling, or a garage or parking area associated therewith.

Class II – Commercial / General Access Vehicular Gate Operator

A vehicular gate operator (or system) intended for use in a commercial location or building such as a multi-family housing unit (five or more single family units), hotel, garages, retail stores, or other building servicing the general public.

Class III – Industrial / Limited Access Vehicular Gate Operator

A vehicular gate operator (or system) intended for use in an industrial location or building such as a factory or loading dock area or other location not intended to service the general public.

Class IV – Restricted Access Vehicular Gate Operator

A vehicular gate operator (or system) intended for use in a guarded industrial location or building such as an airport security area or other restricted access location not servicing the general public, in which unauthorized access is prevented via supervision by security personnel.

500 SERIES RESIDENTIAL SERIES

Model 500A	115-Volt AC Single Phase
Model 500B	220-Volt AC Single Phase
Eliminator Series	Built-in Thermal Overload
Capacitor Rating	40 UF / 10 UF
Standard Working Pressure	1350 psi
Maximum Working Pressure	1750 psi
Pump	Spur Gear 0.5 Liter/Minute
Motor	1/6 Horse Power
Amperage Draw	4 Amps
Duty Cycle (Open/Close)	40 Cycles per Hour
Operator Length (with piston retracted and rear bracket and swivel installed)	27.72 Inches (754 mm)
Operator Length (extended with rear bracket and swivel joint installed)	35.59 Inches (1,004 mm)
Operator Width	3.39 x 3.39 Inches
Operator Height	4.33 (with lock)
Operator Speed (from 0 to 90 Degrees)	12 Seconds
Piston Stroke	7.87 Inches (200 mm)
Maximum Length of Gate	12 Feet
Maximum Weight of Gate Leaf	1,500 Pounds
Ambient Operator Temperature Range	-40°F to 240°F
Recommended Maximum Degree of Opening	90°
Hydraulic Fluid	Fuchs Aceite Multi-Temp

This patented new concept in linear actuator design eliminates the need for physical stops. The valve design cushions the last half inch (or approximately the last 5° to 10°) of piston travel, allowing the piston to reach the end of the stroke in both directions and prevents internal damage.

Operator body fabricated in anodized aluminum
Front and rear flanges are cast aluminum
All internal components are cast and machined
Internal components bathed in oil so virtually no maintenance is required.

BEFORE INSTALLATION

1. Verify the gate post is plum and gate leaf swings freely.
2. Perform any required maintenance before continuing.
3. Verify the commercial power circuit breakers are isolated and rated for the specific load. Visually ensure the circuit breakers are in the **OFF** position and mark the breaker “used”.
4. If any pre-construction wiring has been installed, visually inspect and confirm proper sizing and compliance to code.
5. Automatic vehicular gates are **NOT** approved for pedestrian traffic; however, they can create hazards to unsuspecting pedestrians and domestic animals. Any gate, constructed with reachable pinch points, or that has a surface area that allows arms or legs to pass through it, is a potential hazard. Recommend and provide safety guards against these hazards.
6. Remove the “**End User Safety Advisory Handout**” from this manual. Request the end user review the material and sign it. Collect the signed handout when the installation / job is completed.
7. Remove all pull ropes and remove, or make inoperative, all locks (unless mechanically and/or electrically interlocked to the power unit) connected to the door before installing the operator.

DURING INSTALLATION

****WARNING****

**PLACARDS SHOULD BE MOUNTED IN A VISIBLE
LOCATION ON BOTH SIDES OF THE GATE**

1. Locate the electronic controls far enough from the gate so that the end user can observe, but not touch, the gate while operating the controls.
2. When connecting the wiring from the commercial power source to the control panel, make sure you have provided a proper earth ground. If using a metal enclosure, connect the ground to the enclosure before connecting to the gate operators. **DO NOT** connect the ground directly to the microprocessor control board.
3. Observe all wiring requirements established by the National Electrical Code and/or the authority having jurisdiction.
4. Mount the linear actuator as close to the center of the gate leaf as possible. This will help balance the whipping motion of the gate when the operator reaches the end of the piston stroke.
5. Isolate the linear actuator when welding to prevent any current from passing through the operator and damaging the motor or other components.

INSTALLING THE OPERATOR

This linear actuator must be mounted so the piston FULLY EXTENDS AND FULLY RETRACTS. When fully retracted, there should be 3/8-inch of the piston left out of the front of the casing.

This linear actuator has an offset between the front and rear mounting brackets. The front bracket is approximately 5/8-inch lower than the rear bracket. Review the Bracket Alignment details for the offset dimension. The front bracket has the taller shoulder.

1. Scribe a line from the horizontal support (or desired height for the operator on the gate leaf) onto the gate post.
2. Measure for the offset described above and scribe another line.
3. Cut the rear mounting bracket in accordance with the dimensions specified on the Mounting Geometry detail.
4. Weld the rear mounting bracket to the gate post.
5. Determine the "C" dimension and cut the front mounting bracket to the proper length.
6. Extend the piston to the fully extended position for inward swing gates. This can be achieved by temporarily connecting the control panel to the operator and using the motor to extend the piston, producing 9-7/8" of piston.
7. Screw the I-bolt into the end of the piston ½ of the length of the threads. Attach the front bracket to the operator.
8. Attach the operator to the rear mounting bracket.
9. With the gate in the full CLOSED position, level the operator and scribe the location for the front mounting bracket.
10. Remove the front mounting bracket from the front of the gate operator and weld it to the gate leaf at the scribed location.
11. Attach the operator to the front mounting bracket.
12. Attach an 18/4 stranded S.O. cord approved for outdoor use as per the strain relief assembly to the operator per the electrical connection

NOTE: It is helpful to install a single gang, weather-proof Bell box on the gate post across from the operator. Next, the wire from the control box can be pulled to this point and connected to the S.O. cord inside the Bell box.

**THIS SYSTEM SHOULD ONLY BE INSTALLED AND/OR MODIFIED BY
QUALIFIED TECHNICAL PERSONNEL**

INSTALLATION COMPLETION

WARNING

TO REDUCE THE RISK OF SEVERE INJURY OR DEATH, READ AND FOLLOW ALL INSTALLATION INSTRUCTIONS

1. Install placards and safety equipment and test.
2. Remove all debris and obstructions from the travel path of the gate leaf(s).
3. Turn on and label the commercial power circuit breaker and remove the “used” tag you installed at the beginning of the project.
4. Using the manual bypass, position the gate leaf at 45 degrees. Press the test button on the G2M+ Control Board. The first signal will always be to OPEN. If the operator runs to the CLOSED position, turn off the commercial power and reverse the motor connections on Pins 1 and 3.
5. Operate the actuator several times until you can detect a rise in the hydraulic fluid temperature. This can be determined by placing your hand on the top of the operator at the rear.
6. Purge and adjust the operator as described in “Purging and Adjustments” section.
7. Instruct the end user how to manually release the gate in the event of a power failure.
8. Instruct the end user how to properly operate the gate automation and safety features thereof.
9. Collect the signed “End User Safety Handout”. By signing, the end user acknowledges their understanding of their responsibilities in owning, operating and maintaining a vehicular automatic gate operating system.

PURGING THE OPERATOR

THIS STEP IS NOT REQUIRED UNLESS THE OPERATOR IS RUNNING ERRATICALLY

Occasionally during the shipping process, the 500 Series Operator may be turned upside down. This may require the valve system to be purged after you have completed the installation. It is possible to determine if this is necessary by whether or not the operator runs in a smooth manner. If it does not (if it jerks or runs unevenly), use the Allen wrench provided under the locking cap, turn the manual bypass valve **COUNTER-CLOCKWISE** one-half turn. Slowly swing the operator full open and closed for six to seven complete cycles. Then slowly remove the fill cap on the rear flange of the operator to expel the air. Replace the fill cap.

Tighten the bypass valve with the Allen wrench and signal the operator to run. While the motor is running, open and close the bypass valve, pausing between OPEN and CLOSE. Do this ten to twelve times. When finished, remove the fill cap to expel the air from the operator. Replace the oil filler cap screw and tighten until snug. **DO NOT OVER TIGHTEN.**

ADJUSTING THE OPERATOR

The pressures on the operator are preset at Byan Systems prior to shipment. If the pressures should need to be adjusted, whether higher or lower, you **MUST** adjust both pressure directions the same amount of turns (i.e. $\frac{1}{4}$ turn or $\frac{1}{2}$ turn, etc.)

The Pressure Adjustment screws are found under the locking cap on the top of the operator. Looking from the rear to the front of the operator, the left valve adjusts retracting pressure and the right valve adjusts extending pressure. **Turning these valves clockwise INCREASES pressure, and turning them counter-clockwise DECREASES pressure.**

With the motor running, **DECREASE** the pressures equally until the operator stops moving in both directions. Begin increasing pressure on both valves with the motor running. Adjust the pressure to where it is necessary to physically stop the gate. At this point, either increase the retracting pressure **OR** decrease the extending pressure $\frac{1}{2}$ to $\frac{3}{4}$ of a turn. The retracting pressure **MUST** be higher than the extending pressure.

HYDRAULIC FLUID

Byan Systems Operators use Fuchs Aceite Multi-Temp Hydraulic Fluid. This fluid has a relatively low viscosity enabling it to start flowing more quickly in colder weather. Once the fluid reaches operating temperature, it has a steady flow meaning no rush of thin fluid to cause poor hydraulic performance, or worse yet, excessive pump wear, failure and expensive operational downtime.

Fuchs fluids minimize the effect temperature has on viscosity and resists the shearing action of high speed pumps by maintaining their stable viscosity longer.

There is a zinc type additive in the fluid to help impede wear and premature replacement. It helps prevent corrosion to metals and is designed to be compatible with the hoses, seals and other elastomer products.

Fuchs Aceite Multi-Temp readily separates air and water to prevent foaming, keeping the hydraulic fluid fit and dielectric strength high.

WHERE TO BUY FUCHS ACEITE MULTI-TEMP HYDRAULIC FLUID

At your nearest Fuchs Oil Distributor, Byan Systems Distributor, or at Byan Systems Warehouse.

FLUID AND YOUR OPERATOR

The proper level can be observed through the oil filler tube, located on the top of the rear flange of the operator, with the piston in the retraction position. The fluid should be visible at the bottom of the tube, level with the curved section of the tube. The 500 Series Operator has a pressured chamber so **DO NOT OVERFILL**. The pump will intermittently fail to draw fluid and will fail to run in one direction or the other.

ADJUSTABLE FLOW CONTROL

The operator has adjustable flow control to allow for speed adjustment. This helps with heavy gates and wind loads. There is a built-in slow down on the last $\frac{3}{4}$ " of the piston's travel which eliminates the need for the installation of physical stops.

MANUAL BYPASS

The manual bypass valve is for the ability to release the operator in the event of a power failure or malfunction. It is located under the keyed cap on top of the operator. A Metric Allen wrench is provided and is located in the cap to release the bypass valve. Turn the valve counter-clockwise until the operator releases. When tightening the bypass valve, it must be tight in order to prevent fluid or pressure from escaping backing into the chamber.

PLACARDS AND SAFETY EQUIPMENT

The placards should be installed (one on each side of the gate) so that they are visible to anyone that approaches the gate. The safety equipment should be tested before leaving the gate site.

PRESSURE AND FLOW CONTROL

When mounting the operator to your gate, **always** make sure that the side with the lock cap (or the Green and Red Pressure Adjustment Screws) is facing upward. Mounting your operator in an upside-down position will result in it failing to run properly.

◆ Pressure and flow control are factory set for best performance.

◆ If pressure adjustment is required, the Extend and Retract pressures must be adjusted **equally**. Equal adjustment to controls is required to increase and decrease pressure.

◆ Flow control is set by the factory for maximum speed.

◆ To reduce the operator's speed, turn the flow control screw clockwise up to one-half turn.

◆ **DO NOT TURN THE FLOW CONTROL ADJUSTMENT SCREW COUNTER-CLOCKWISE FROM THE FACTORY SETTING.**

◆ The manual by-pass screw is set at the factory and can be released with the allen wrench provided. **Do not turn more than one turn counter-clockwise to move the gate manually.**

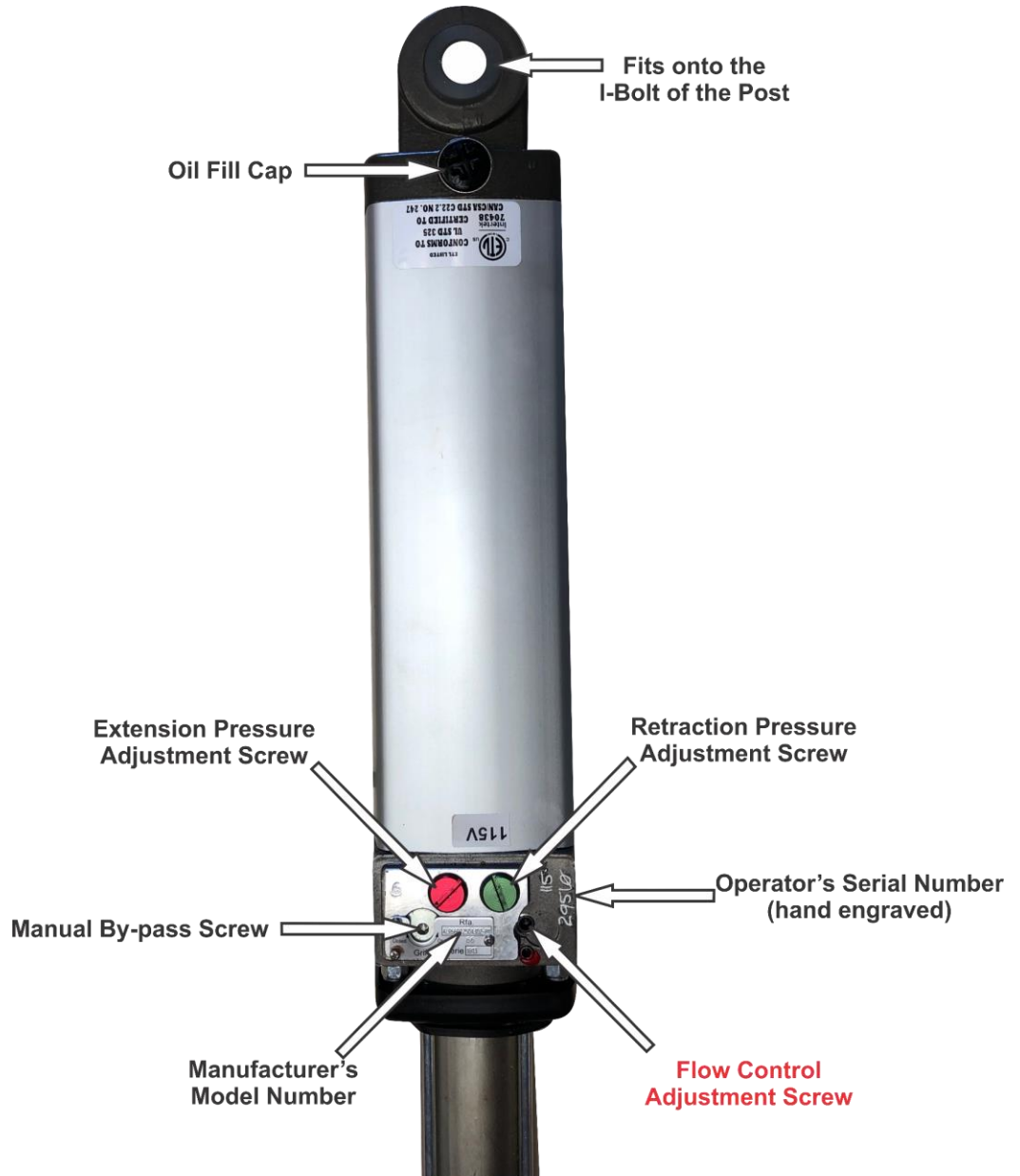

(TOP VIEW OF OPERATOR)

Mounting Pins and Brackets

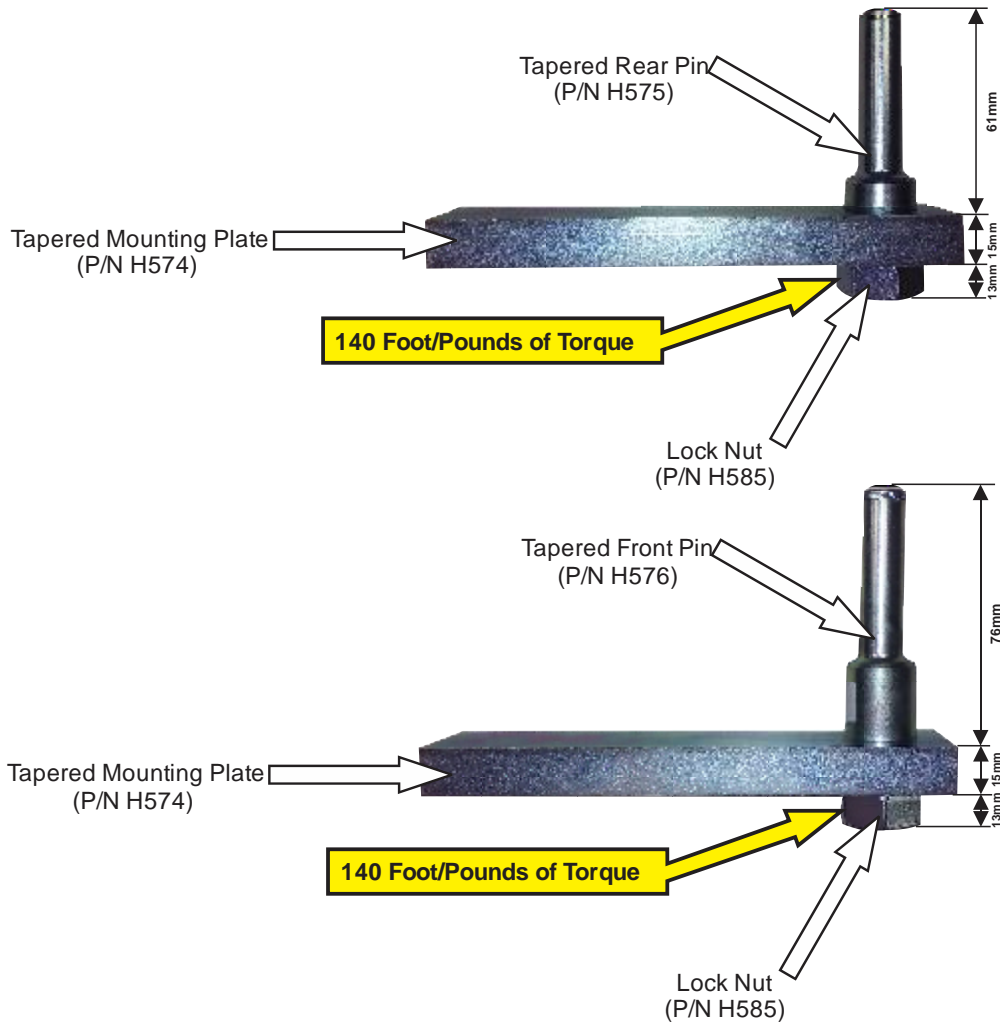

I-Bolt Complete with Lock Nut (P/N H589)



(Top View)



(Side View)

Byan Systems Adjustable Hardware Options



**Tapered Mount Plate
(P/N H574)**
Standard



**Adjustable Rear Mount Plate
(P/N PT150)**
Optional

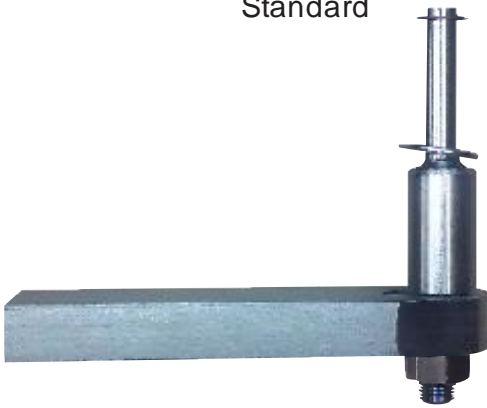

**Adjustable Rear Mount Plate
with
Adjustable Rear Mount Pin
(Side View)**



**Adjustable Rear Mount Plate
with
Adjustable Rear Mount Pin
(Top View)**



**Adjustable Rear Mount Pin
(P/N PT160)**



**Swivel Joint 2 Pc Rod End
(P/N FK689)**



**16mm Swivel Joint Front Pin
(P/N PT687)**

500 Residential Operator

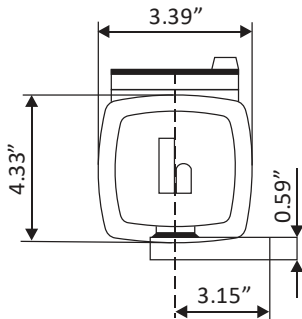
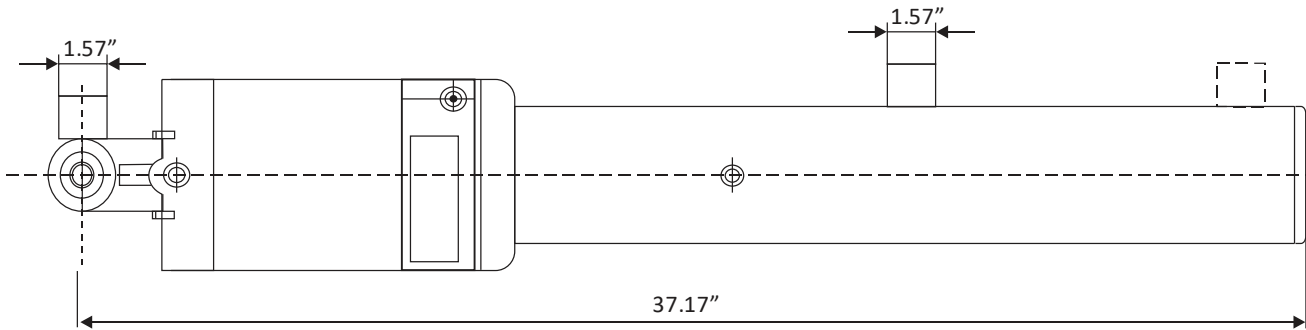
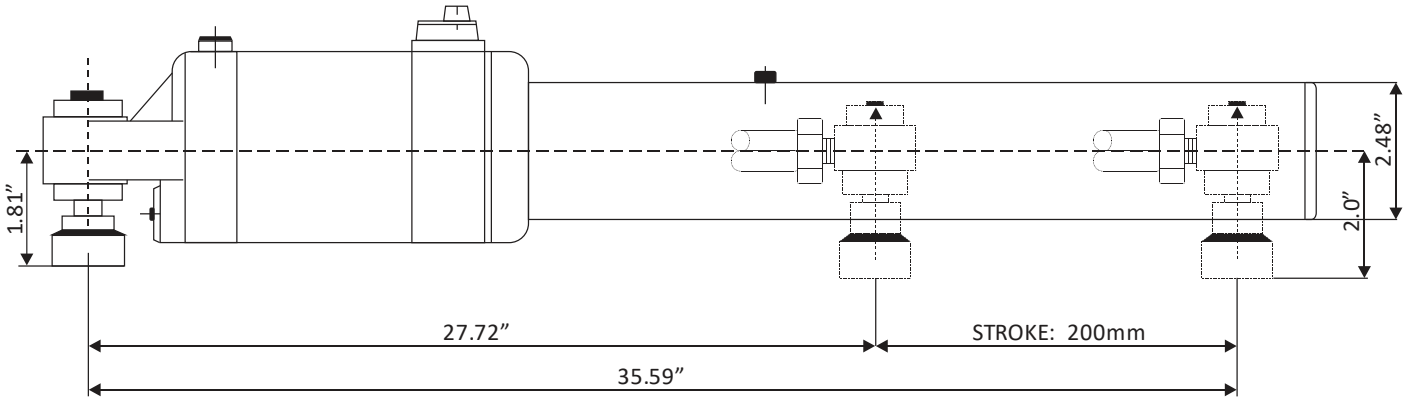

NOTE: WHEN THE OPERATOR IS CORRECTLY INSTALLED THE FRONT MOUNTING BRACKET WILL BE 3/16" LOWER THAN THE REAR MOUNTING BRACKET.

500 RESIDENTIAL OPERATOR MOUNTING DIMENSIONS (200mm Stroke)

INWARD SWING

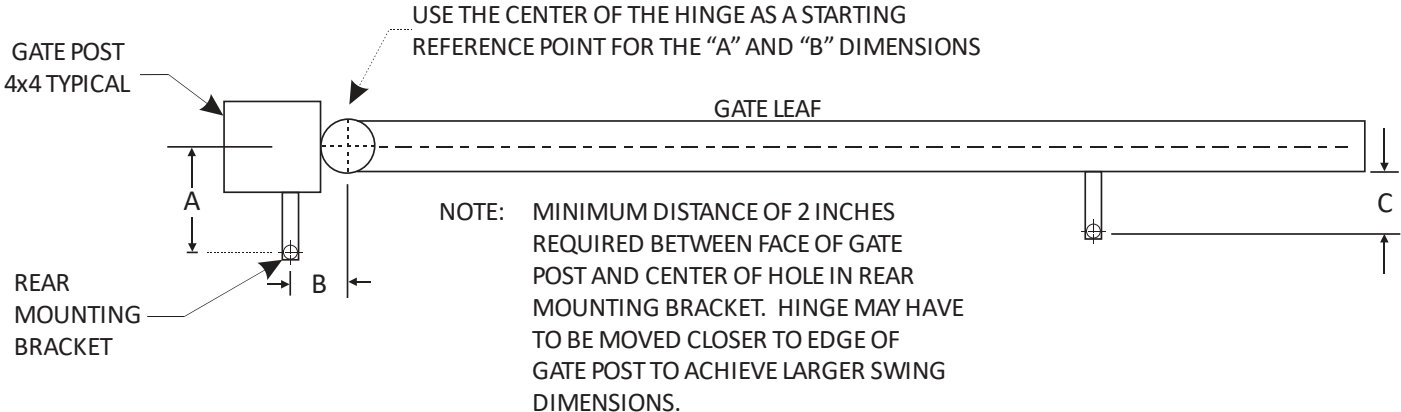

OUTWARD SWING

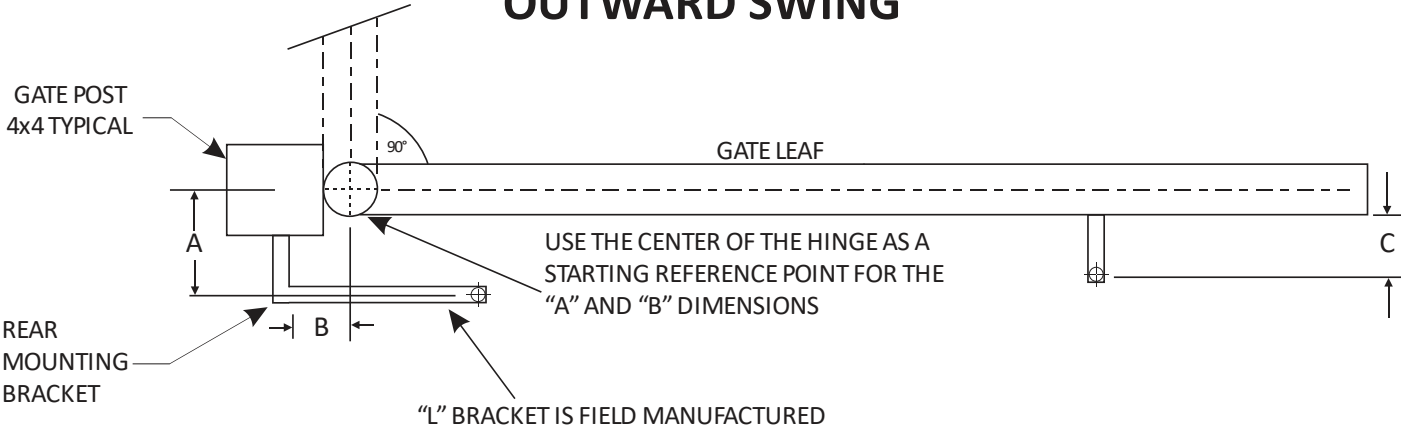

500 RESIDENTIAL OPERATOR

Mounting Dimensions

(These dimensions are calculated using a 4-inch gate post, a 2-inch gate leaf, and a 3-inch distance from the face of the gate post to the center of the gate hinge. **Your dimensions may be slightly different, so please use accurate measurements.**)

We have used a -1.0-inch offset in calculating the dimensions for the 90 degree opening of the Inward Swing in order to move the operator a little further from the gate's post.

Inward Swing

DEGREE OF ANGLE	A DIMENSION	B DIMENSION	C DIMENSION
75	5-1/8"	3-3/4"	2-1/2"
80	4-3/4"	3-3/4"	2-1/2"
85	4-1/2"	3-3/4"	2-1/2"
90	4-1/8"	3-3/4"	2-1/4"

Outward Swing

DEGREE OF ANGLE	A DIMENSION	B DIMENSION	C DIMENSION
75	5-3/8"	3-3/4"	2-1/2"
80	5"	3-3/4"	2-1/2"
85	4-1/2"	3-3/4"	2-1/2"
90	4-1/8"	3-3/4"	2-1/2"

(Please contact Byan Systems with your gate measurements for anything less than 75 degrees and more than 90 degrees.)

RECOMMENDED WIRE SIZES

Voltage drop becomes important when the length of a run of wire or cable becomes very long. Usually this is not a problem in circuits within a house, but may become an issue when running wire to your gate's control box.

Excessive voltage drop can cause loss of efficiency in operation of your gate system. It not only can even result in shortening the life of your electronic equipment.

To avoid excessive voltage drop, select wire size that will minimize voltage drop, you will need to know the length of the wire run and the amp load or current that will be on the circuit. To determine amps, add up the wattage of all electrical devices that will be on the circuit and divide the total by the voltage of the circuit (either 110 volts or 220 volts).

110 VOLT, SINGLE PHASE, MAXIMUM 3% VOLTAGE DROP*						
	Length of Run					
	25'	50'	100'	150'	200'	Amp Load
Copper	14 gauge	12 gauge	8 gauge	6 gauge	6 gauge	15 AMP
Copper	12 gauge	10 gauge	8 gauge	6 gauge	4 gauge	20 AMP

220 VOLT, SINGLE PHASE, MAXIMUM 3% VOLTAGE DROP*						
	Length of Run					
	25'	50'	100'	150'	200'	Amp Load
Copper	14 gauge	14 gauge	12 gauge	10 gauge	8 gauge	15 AMP
Copper	12 gauge	12 gauge	10 gauge	8 gauge	8 gauge	20 AMP

NOTE: These wire sizes are only general recommendations. Federal, state and local codes ALWAYS take precedence. Consult the National Electrical Code or local authority having jurisdiction if you have wiring concerns.

*The tables above apply to the single phase systems, in steel conduit, at a conductor operating temperature of 167°F (75°C). It assumes a power factor of one. The table may be used for systems using non-steel conduit, but actual results for these conditions may result in a greater voltage drop.

WARNING! Installation of electrical wire can be hazardous, if done improperly and can result in personal injury or property damage. For safe wiring practices, consult the National Electrical Code and your local building inspector.

BYAN SYSTEMS G2M+ CONTROL BOARD

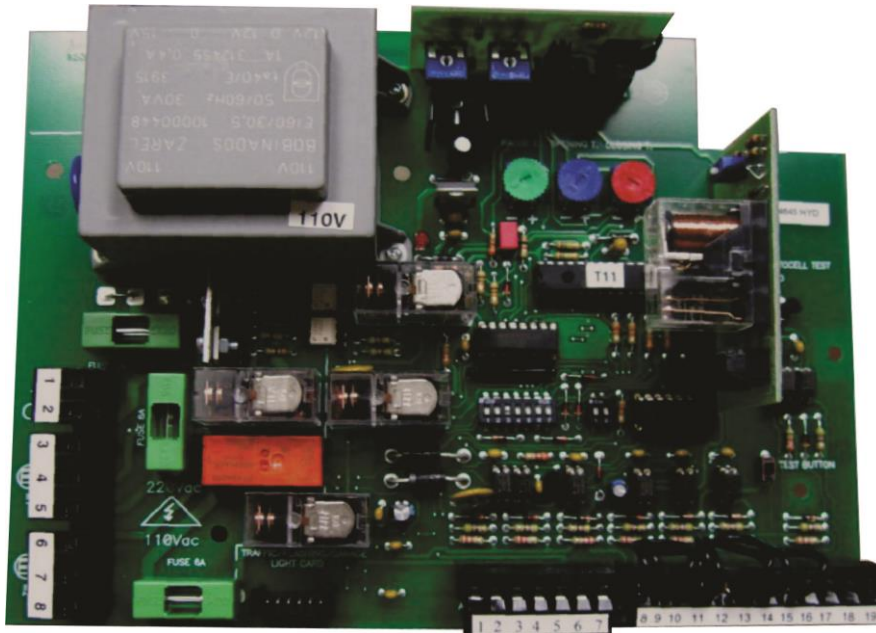

The Byan Systems G2M+ Control Board is designed for both 10K Ω and Normally Closed technology safety devices by implementation of a built-in daughter card. The G2M+ is a single phase, microprocessor controlled unit. It is capable of controlling up to two $\frac{3}{4}$ -hp, 115-Volt or 220-Volt AC motors. Two different plug-in accessory cards are available for the G2M+: a leaf delay card (which comes standard with every board), and a traffic light card (which is available separately). There are three timing potentiometers as well as nine DIP switches incorporated into the board to control different output functions.

This control board is required to have two separately connected, monitored safety devices installed, either **photocells (through-beam or a reflective) and/or sensing edges may be used** (See Page 48).

Photocell power must be connected to the 24+ Terminal above Terminal 18 on the backplate or to the red wire from the daughter card. The other power lead from the photocell should be connected to Terminal 18 on the backplate or Terminal 3 of the G2M+ board. The other red wire should be connected to Terminal 19 on the backplate or Terminal 4 of the G2M+ board.

To operate the control board, the micro switch that is on the photocell card must be in the ON position and after any changes are made to safety devices, it must be reset. If the photocells fail to work, it is possible to run the operator by mode of a constant pressure switch using the Command Open and Command Close inputs. To use this procedure, a constant pressure switch must be pressed continuously for three (3) seconds to start movement and remain depressed through the entire cycle.

The Byan Systems G2M+ Control Board is UL 325 compliant and monitors devices in both directions (open and close). This means that if the gate comes into contact with an object, it will stop and reverse briefly. If the object is hit a second time, or if a monitored safety device fails, the board will lock out and must then be manually reset before the system will operate again. (This includes a broken photocell beam.) **Any time a safety connection is changed, you must also reset the board. This is done by shutting off the power switch and turning it back on.**

Per the current UL 325 requirements, all new automated gate systems (post 2016) require a minimum of two entrapment prevention devices, connected separately. Both safety devices **MUST** be monitored in both the open and close functions. You must also have either an audible or visual alarm device in operation. **Please follow all installation instructions from the accessory's manufacturer.**

Terminal Strips:

There are two sets of terminals on the G2M+ control board. The first terminal strip is the Power and Motor Run Terminal Block, located on the left side of the board below the transformer. This is where the incoming commercial power and the outgoing power to the operators are connected. This terminal strip is made up of three terminal blocks: 1) In-coming Power; 2) Motor One; and 3) Motor Two.

Power and Motor Run Terminals

Terminal Number	Terminal Name / Description	Wire Colors
1	Commercial Power Input Neutral	115V White / 220V Black
2	Commercial Power Input Hot	115V Black / 220V Red
3	Motor One Close Directional	Black
4	Motor One Open Directional	Red
5	Motor One Common	White
6	Motor Two Close Directional	Black
7	Motor Two Open Directional	Red
8	Motor Two Common	White

Commercial Power Hook-Up*:

1. Hook up commercial power to Terminals 1 and 2 of the Power and Motor Run Terminal Strip.
2. Connect leads from the Motor No. 1 operator to Terminals 3, 4, and 5 of the Power and Motor Run Terminal Strip.
3. Connect leads from the Motor No. 2 operator to Terminals 6, 7 and 8 of the Power and Motor Run Terminal Strip.
4. Connect Motor Run Capacitors across each set of directional motor leads (between Terminals 3 and 4, and Terminals 6 and 7).

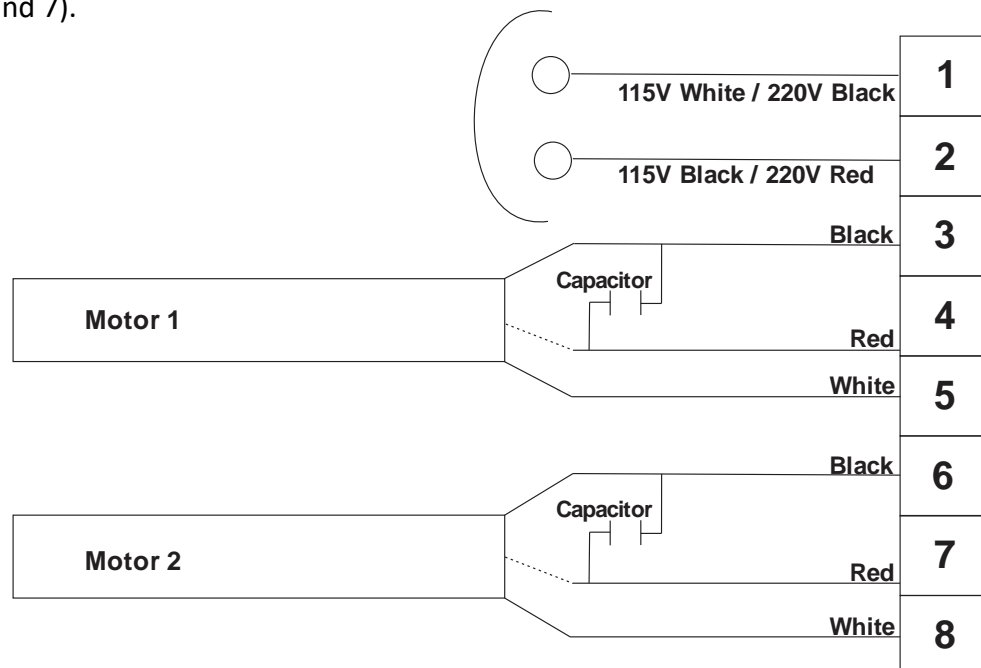

The second terminal strip is the Accessory Terminal Strip. This is where **ALL** of the accessories are connected to the controller board. This terminal strip is located on the bottom right of the G2M+ Controller Board. This terminal strip consists of two socketed blocks to allow you to unplug the connector as a whole without removing wires. The drawings on Pages 10-12 are color-coded for ease in determining wiring connections for accessories.

Accessory Terminal Table

Terminal Numbers	Terminal Name	Possible Uses
1 - 2	Alarm Output	These terminals allow the connection of a device to alert the user that people safe has been activated.
3 - 4	24-Volt AC 1-Amp Output	Power for accessories such as radio receivers, loop detectors, or anything requiring 24-Volt AC 1-Amp may be connected here.
5 - 6	12-Volt DC 1-Amp Pulsed Electric Lock Output	Magnetic or other types of lock release signals may be connected here.
7 - 9	People Safe Alarm Reset Input	A button or other Normally Open contact may be connected here to reset the People Safe alarm output relay.
8	People Safe Input	Normally Closed People Safe devices such as sensing edges are connected here.
9	Safety Common Input	Common wires for people and car safety devices are connected here.
10	Car Safe Input	Normally Closed Car Safe devices such as loop detectors and photo beams are connected here.
11	Limit Switch Common Input	If limit switches are required, the common wires would be connected here.
12	Close Limit Switch Input	If limit switches are required, the close limit switch would be connected here.
13	Open Limit Switch Input	If limit switches are required, the open limit switch would be connected here.
14 - 15	Stop Input	A Normally Closed device used to stop the operators such as a button may be connected here.
16	Control Function Common Input	This is where the common of devices used to open, close, or reverse the gate would be connected.
17	Close Function Input	Devices only used to close the gate such as in-ground loops, buttons, or photo beams are connected here.
18	Open Function Input	Devices only used to open the gate such as in-ground loops, buttons, or radio receivers are connected here. (Any Normally Open devices used to access the gate key pads, card readers, etc.)
19	Reverse Function Input	Devices used to reverse the gates' direction such as in-ground loops, buttons, or radio receivers are connected here.
24+	Monitored Safety Input	Provides 24-Volt power to the daughter card for controlling add-ons such as keypads, photocells, etc.

Accessory Hook-Ups*:

There are many accessories available that are compatible with the G2M+ that will give the end user different options for safety, security, and system operations. Since it would be impossible to outline all possible combinations, we will simply outline a few of the most common. Keep in mind; these instructions are specific to the brand and model most commonly used by Byan Systems. Your accessories may differ from the ones listed below. **ALWAYS consult the Installation Instructions included with an accessory before connecting it to any operating system.**

Per the current UL 325 requirements, all new automated gate systems (post 2016) require a minimum of two monitored entrapment prevention devices, separately connected. Monitoring **MUST** occur in both open and close functions. You must also have either an audible or visual alarm device in operation.

The Byan Systems G2M+ Control Board is capable of handling a maximum of 8 accessories (wired together in series) and one accessory wired in parallel.

Linear GRD_1 Radio Receiver:

1. Separate the four wires coming out of the bottom of the Receiver (1 Red, 1 Black, and 2 Gray).
2. Connect the black wire to Terminal 3 of the Accessory Terminal Strip.
3. Connect the red wire to Terminal 4 of the Accessory Terminal Strip.
4. Connect one of the gray wires to Terminal 16 of the Accessory Terminal Strip.
5. Connect the other gray wire to Terminal 18 of the Accessory Terminal Strip for open only or Terminal 19 for use as a reversing device.
6. If an external antenna is required, locate the Bulk Head Connector supplied with the Receiver.
7. Drill one 3/8" hole in the enclosure where you would like to mount the antenna.
8. Install the Bulk Head Connector in the hole using the hardware included with the Receiver. Be sure to use thread locking compound in the threads when installing the connector.
9. Connect the supplied coax between the Receiver and the Bulk Head Connector and attach the antenna to the outside of the connector.

Mag-Lock Relay Using IDEC SH2B-05 Base w/RH2B-UDC12V Relay:

1. Connect Terminal 13 on the Relay Base to Terminal 5 of the Accessory Terminal Strip on the board.
2. Connect Terminal 14 on the Relay Base to Terminal 6 of the Accessory Terminal Strip on the board.
3. Connect Neutral or Ground from the Mag-Lock Transformer directly to the Mag-Lock.
4. Connect Hot from the Mag-Lock Transformer to Terminal 9 of the Relay Base.
5. Connect Terminal 1 on the Relay Base to the Mag-Lock.

Loop Detector Using IDEC SR3P-06 Base w/EDI LMA1500-120 Loop Detector:

1. Connect Terminals 7 and 8 to the in-ground loop leads.
2. Connect 120-Volt AC Neutral to Terminal 2 of the Detector Base.
3. Connect 120-Volt AC Hot to Terminal 1 of the Detector Base.
4. Connect desired signal wires from the Detector Base to the Accessory Terminal Strip of the G2M+.

Shadow Using IDEC SH2B-05 Relay Base and RH2B-UAC110-120 Relay:

1. Connect Terminal 9 of the Relay Base to Terminal 5 of the Detector Base.
2. Connect Terminal 5 of the Detector Base to Terminal 9 of the Accessory Terminal Strip.
3. Connect Terminal 5 of the Relay Base to Terminal 10 of the Detector Base.
4. Connect Terminal 10 of the Detector Base to Terminal 10 of the Accessory Terminal Strip.

Safety:

1. Connect Terminal 5 of the Detector Base to Terminal 9 of the Accessory Terminal Strip.
2. Connect Terminal 10 of the Detector Base to Terminal 10 of the Accessory Terminal Strip.

Free Exit:

1. Connect Terminal 5 of the Detector Base to Terminal 16 of the Accessory Terminal Strip.
2. Connect Terminal 6 of the Detector Base to Terminal 18 of the Accessory Terminal Strip.

The Byan Systems G2M+ Control Board is UL 325 compliant and monitors devices in both directions (open and close). This means that if the gate comes into contact with an object, it will stop and reverse briefly. If the object is hit a second time, or if a monitored safety device fails, the board will lock out and must then be manually reset before the system will operate again. (This includes a broken photocell beam.)

Characteristics:

Adjustable Timing Potentiometers:

Color	Description	Minimum Time	Maximum Time
Green	Automatic Closing Timer	1 Second	1 Minute 30 Seconds
Blue	Opening Timer	3 Seconds	30 Seconds *
Red	Closing Timer	3 Seconds	30 Seconds *

*With DIP Switch 1 on S2 turned on, the maximum open and close times are doubled to 1 Minute.

DIP SWITCHES:

Table S1

Number	Option Name	Option Description
1	Reversing Stroke Function	When turned on, the operators will first close for 1 second before opening.
2	Step-by-step Function	When turned on, each movement of the operators by any reverse input will require an individual input (deactivates automatic re-open function).
3	Automatic Closing Function	When turned on, the operators will close by the time set with the green timing potentiometer.
4	Reverse Button Inoperative During Opening	When turned on, any reverse input is deactivated during the open cycle.
5	Closing Order by Car Safety Contact	With DIP switch 3 off and 5 turned on, the operators will close as soon as the car safety contacts are cleared.
6	*See Below	*See Below
7	Car Safety Contact Operative During Opening	When turned on, car safety contacts are active during the open and close cycles. Input safety for vehicles only works on closing movement unless Switch 7 is set ON.

*The function of DIP switch 6 is changed by the position of the jumper (JP1) located below the radio receiver card (J3). Table S1a describes the function of DIP switch 6 and its relation to JP1.

Table S1a

	JP1 Open	JP1 Closed
DIP Switch 6 ON	When power is applied to the board, operators will automatically perform a closing function.	The traffic light card will act as a flashing light card (upper relay) and a garage light card (lower relay).
DIP Switch 6 OFF	When power is applied to the board, the operator will automatically perform an opening function.	The traffic light card relays will act as a green light (upper relay) and a red light (lower relay).

Table S2

Number	Option Name	Option Description
1	Double Timing	When turned on, maximum opening and closing time is extended from 30 Seconds to 1 Minute and maximum pause time is extended from 45 Seconds to 1 Minute 30 Seconds.
2	Repositioning the Gate	When turned on, the operators will cycle in the last direction of operation for 2 seconds every hour

Byan Systems 12 x 10 Prewire Layouts:

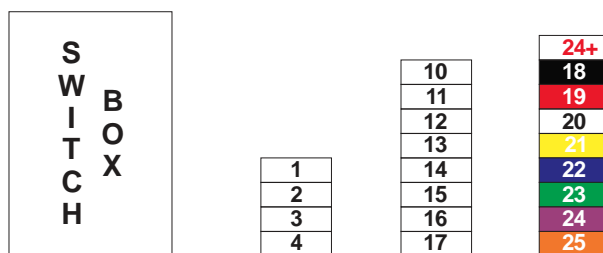
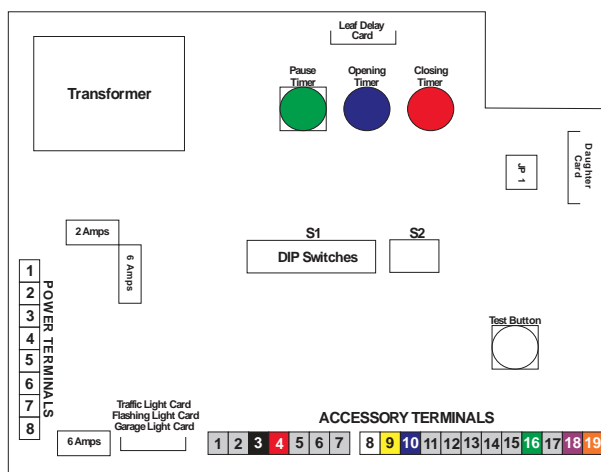

NOTE: When Leaf Delay is engaged, Motor 1 will open first and Motor 2 will close first.

TERMINAL BLOCK 1

1	220-Volt AC Hot
2	115-Volt AC Hot
3	115-Volt AC Neutral
4	Ground

COMMERCIAL POWER

(Red)
(Black)
(White)
(Green)

TERMINAL BLOCK 2

10	Ground
11	Motor Directional
12	Motor 1 Directional
13	Motor 1 Common
14	Ground
15	Motor 2 Directional
16	Motor 2 Directional
17	Motor 2 Common

OPERATOR MOTOR TERMINALS

(Green)
(Black)
(Red)
(White)
(Green)
(Black)
(Red)
(White)

TERMINAL BLOCK 3

24+	Monitored Safety
18	24-Volt AC Common
19	24-Volt AC Positive
20	People Safe (Normally Closed)
21	Common Safety
22	Car Safe
23	Common Open/Reversing
24	Command Open (Normally Open)
25	Command Reversing (Normally Open)

ACCESSORY TERMINALS

(Red)
(Black)
(Red)
(White)
(Yellow)
(Blue)
(Green)
(Purple)
(Orange)

20 x 16 PREWIRE LAYOUT

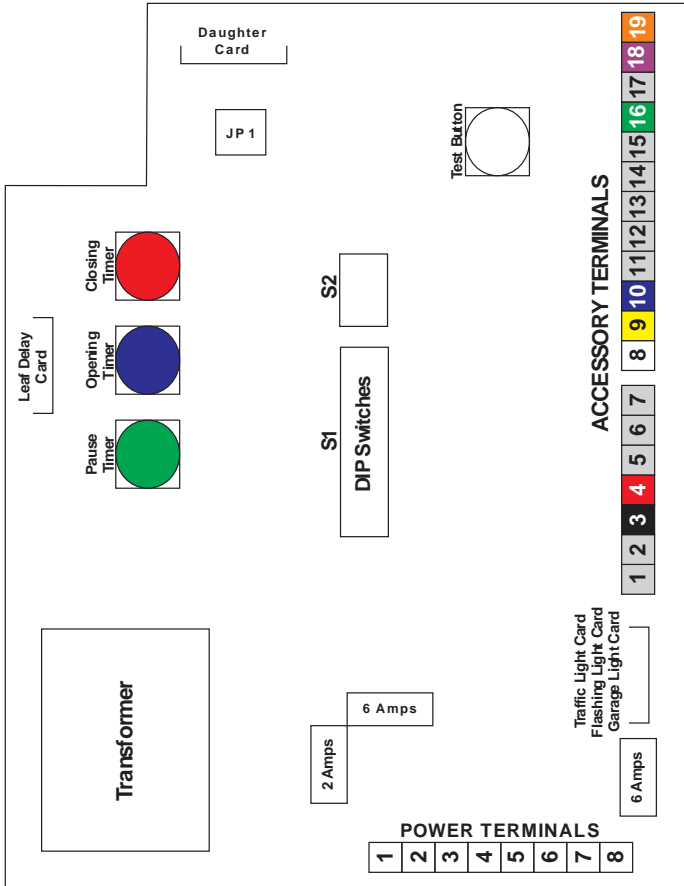

TB1 COMMERCIAL POWER TERMINALS

- 1 220-VOLT AC HOT (RED)
- 2 115-VOLT AC HOT (BLACK)
- 3 115-VOLT AC NEUTRAL (WHITE)
- 4 GROUND (GREEN)

TB2 OPERATOR MOTOR TERMINALS

- 5 UN-INTERRUPTIBLE 115-VOLT AC (BLACK)
- 6 UN-INTERRUPTIBLE 115-VOLT AC (WHITE)
- 7 GROUND (GREEN)

3 INTERRUPTED VOLTAGE TERMINALS

- 8 INTERRUPTED HIGH VOLTAGE 115-VOLT AC (BLACK)
- 9 INTERRUPTED HIGH VOLTAGE 115-VOLT AC (WHITE)

TB4 OPERATOR MOTOR TERMINALS

- 10 GROUND (GREEN)
- 11 MOTOR 1 DIRECTIONAL (BLACK)
- 12 MOTOR 1 DIRECTIONAL (RED)
- 13 MOTOR 1 COMMON (WHITE)
- 14 GROUND (GREEN)
- 15 MOTOR 2 DIRECTIONAL (BLACK)
- 16 MOTOR 2 DIRECTIONAL (RED)
- 17 MOTOR 2 COMMON (WHITE)

TB5 ACCESSORY TERMINALS

- 24+ MONITORED SAFETY (RED)
- 18 24-VOLT AC COMMON (BLACK)
- 19 24-VOLT AC POSITIVE (RED)
- 20 PEOPLE SAFE (NORMALLY CLOSED) (WHITE)
- 21 COMMON SAFETY (YELLOW)
- 22 CAR SAFE (BLUE)
- 23 COMMON OPEN/REVERSING (GREEN)
- 24 COMMAND OPEN (NORMALLY OPEN) (PURPLE)
- 25 COMMAND REVERSING (NORMALLY OPEN) (ORANGE)

TB6 LOOP TERMINALS

- 26 FREE EXIT LOOP (GRAY)
- 27 FREE EXIT LOOP (BROWN)
- 28 SAFETY LOOP (GRAY)
- 29 SAFETY LOOP (BROWN)
- 30 SHADOW LOOP (GRAY)
- 31 SHADOW LOOP (BROWN)

TB7 MAG-LOCK TERMINALS

- 32 MAG-LOCK (BROWN)
- 33 MAG-LOCK (BROWN)

NOTE: WHEN LEAF DELAY IS ENGAGED, MOTOR 1 WILL OPEN FIRST AND MOTOR 2 WILL CLOSE FIRST

(Optional)

LOW VOLTAGE SURGE PROTECTOR

(Optional)

HIGH VOLTAGE SURGE PROTECTOR

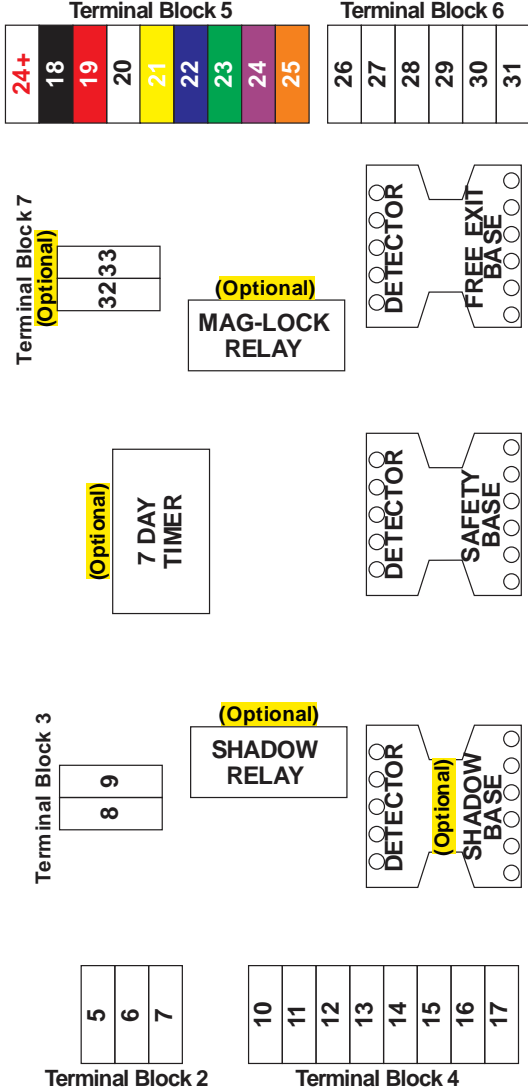

24 x 20 PREWIRE LAYOUT

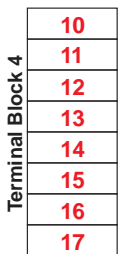
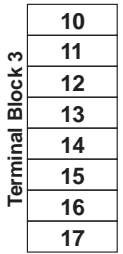
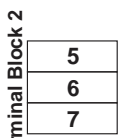
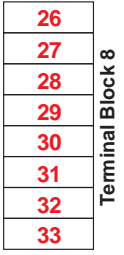
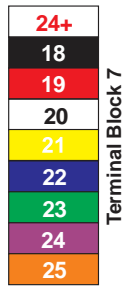
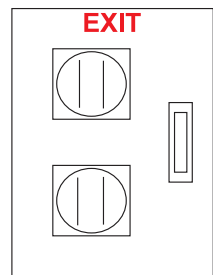
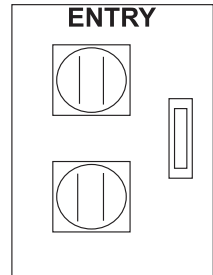
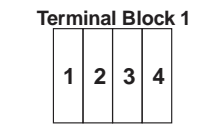
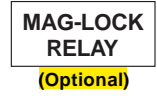
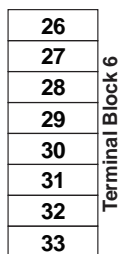
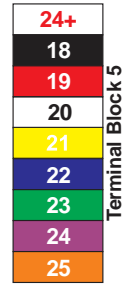
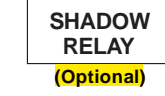
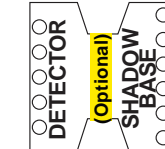
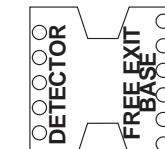
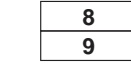
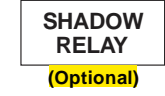
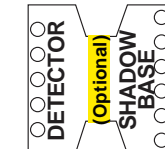
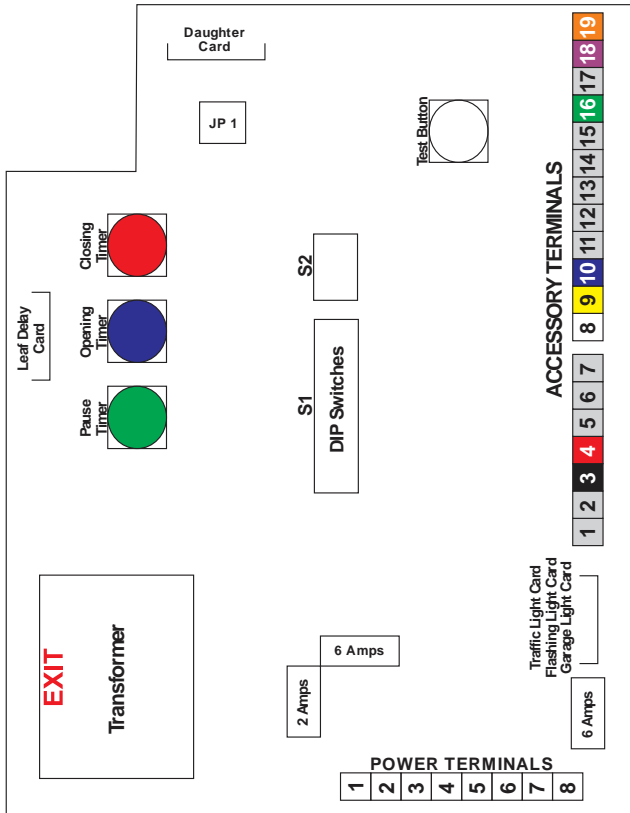
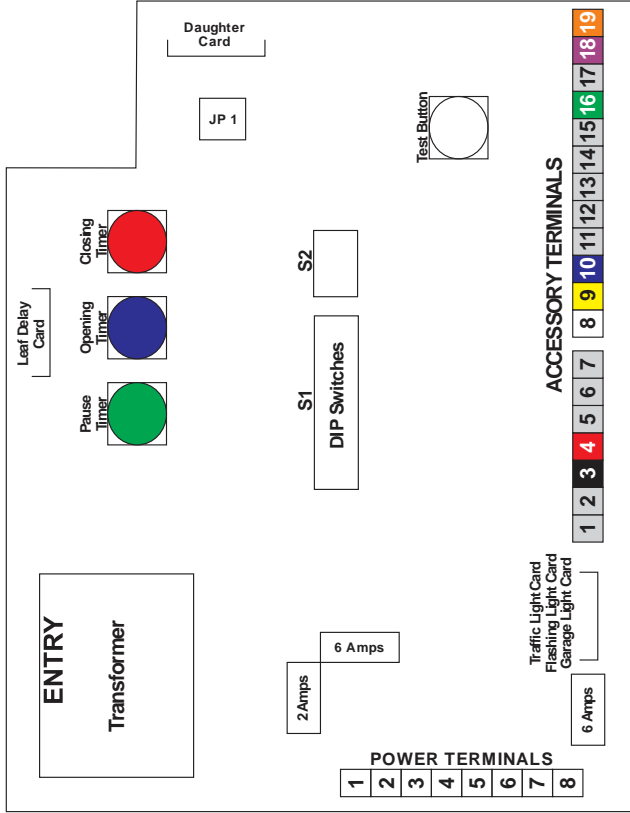

24 x 20 PREWIRE TERMINAL STRIP GUIDE

TB1 COMMERCIAL POWER

1	220-VOLT AC HOT	(RED)
2	115-VOLT AC HOT	(BLACK)
3	115-VOLT AC NEUTRAL	(WHITE)
4	GROUND	(GREEN)

TB3 OPERATOR MOTOR TERMINALS

10	GROUND	(GREEN)
11	MOTOR 1 DIRECTIONAL	(BLACK)
12	MOTOR 1 DIRECTIONAL	(RED)
13	MOTOR 1 COMMON	(WHITE)
14	GROUND	(GREEN)
15	MOTOR 2 DIRECTIONAL	(BLACK)
16	MOTOR 2 DIRECTIONAL	(RED)
17	MOTOR 2 COMMON	(WHITE)

TB5 ENTRY ACCESSORY TERMINALS

24+	MONITORED SAFETY	(RED)
18	24-VOLT AC COMMON	(BLACK)
19	24-VOLT AC POSITIVE	(RED)
20	PEOPLE SAFE (NORMALLY CLOSED)	(WHITE)
21	COMMON SAFETY	(YELLOW)
22	CAR SAFE	(BLUE)
23	COMMON OPEN / REVERSING	(GREEN)
24	COMMAND OPEN (NORMALLY OPEN)	(PURPLE)
25	COMMAND REVERSING (NORMALLY OPEN)	(ORANGE)

TB6 ENTRY LOOP TERMINALS

28	SAFETY LOOP	(GRAY)
29	SAFETY LOOP	(BROWN)
30	SHADOW LOOP	(GRAY)
31	SHADOW LOOP	(BROWN)
32	MAG-LOCK	(BROWN)
33	MAG-LOCK	(BROWN)

TB9 ENTRY INTERRUPTED VOLTAGE TERMINALS

8	INTERRUPTED HIGH VOLTAGE 115-VOLT AC	(BLACK)
9	INTERRUPTED HIGH VOLTAGE 115-VOLT AC	(WHITE)

TB2 OPERATOR MOTOR TERMINALS

5	UNINTERRUPTIBLE 115-VOLT AC	(BLACK)
6	UNINTERRUPTIBLE 115-VOLT AC	(WHITE)
7	GROUND	(GREEN)

TB4 EXIT OPERATOR MOTOR TERMINALS

10	GROUND	(GREEN)
11	MOTOR 1 DIRECTIONAL	(BLACK)
12	MOTOR 1 DIRECTIONAL	(RED)
13	MOTOR 1 COMMON	(WHITE)
14	GROUND	(GREEN)
15	MOTOR 2 DIRECTIONAL	(BLACK)
16	MOTOR 2 DIRECTIONAL	(RED)
17	MOTOR 2 COMMON	(WHITE)

TB7 EXIT ACCESSORY TERMINALS

24+	MONITORED SAFETY	(RED)
18	24-VOLT AC COMMON	(BLACK)
19	24-VOLT AC POSITIVE	(RED)
20	PEOPLE SAFE (NORMALLY CONNECTED)	(WHITE)
21	COMMON SAFETY	(YELLOW)
22	CAR SAFE	(BLUE)
23	COMMON OPEN / REVERSING	(GREEN)
24	COMMAND OPEN (NORMALLY OPEN)	(PURPLE)
25	COMMAND REVERSING (NORMALLY OPEN)	(ORANGE)

TB8 EXIT LOOP TERMINALS

26	FREE EXIT LOOP	(GRAY)
27	FREE EXIT LOOP	(BROWN)
28	SAFETY LOOP	(GRAY)
29	SAFETY LOOP	(BROWN)
30	SHADOW LOOP	(GRAY)
31	SHADOW LOOP	(BROWN)
32	MAG-LOCK	(BROWN)
33	MAG-LOCK	(BROWN)

TB10 EXIT INTERRUPTED VOLTAGE TERMINALS

8	INTERRUPTED HIGH VOLTAGE 115-VOLT AC	(BLACK)
9	INTERRUPTED HIGH VOLTAGE 115-VOLT AC	(WHITE)

NOTE: WHEN LEAF DELAY IS ENGAGED, MOTOR 1 WILL OPEN FIRST AND MOTOR 2 WILL CLOSE FIRST.

20x16 Prewired Enclosure with Safety, Shadow & Free Exit Bases Wired to 2 Sets of Photobeams

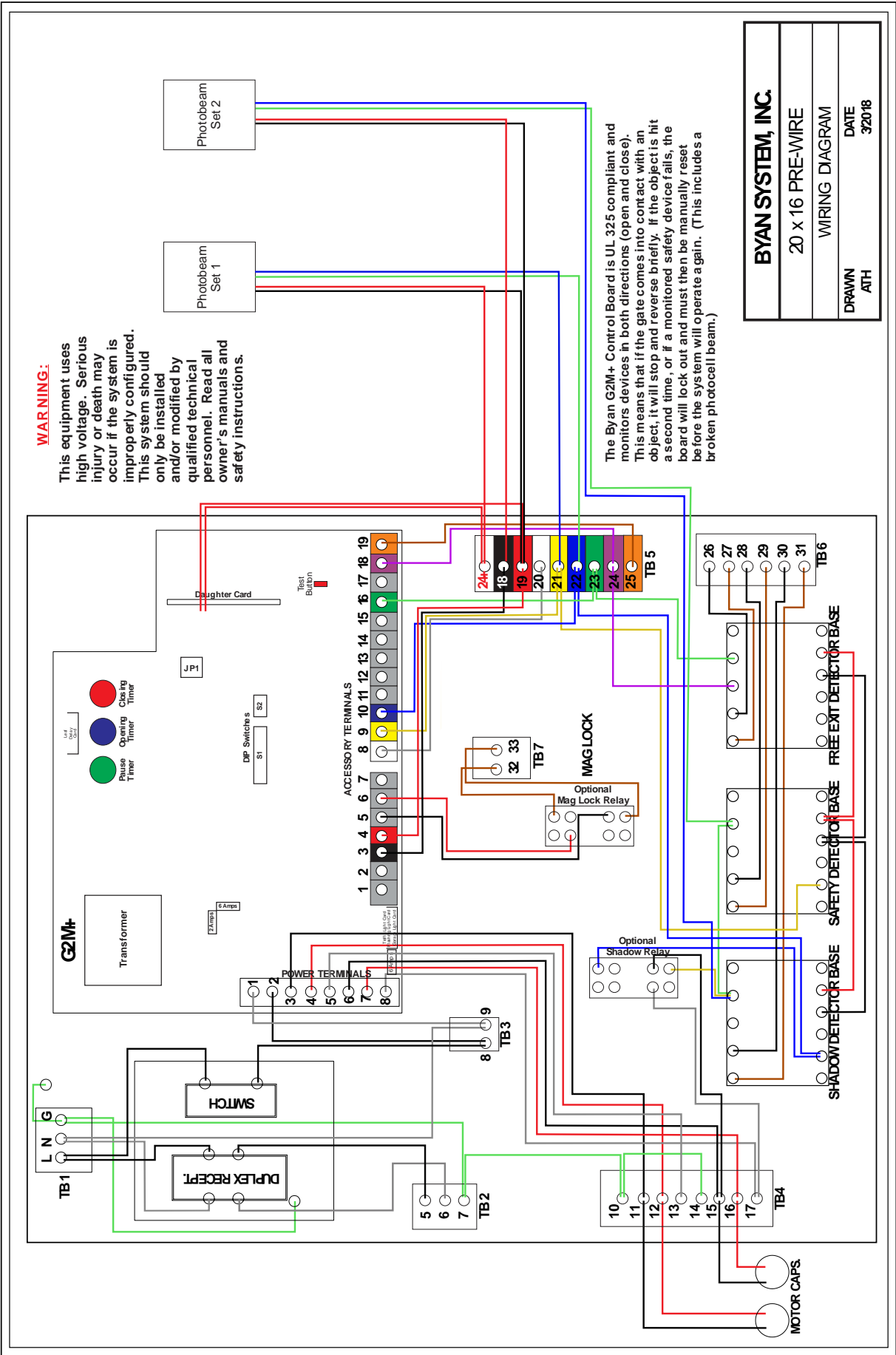

BYAN 20x16 PREWIRE CONNECTED TO 2 SETS OF PHOTOBEAMS

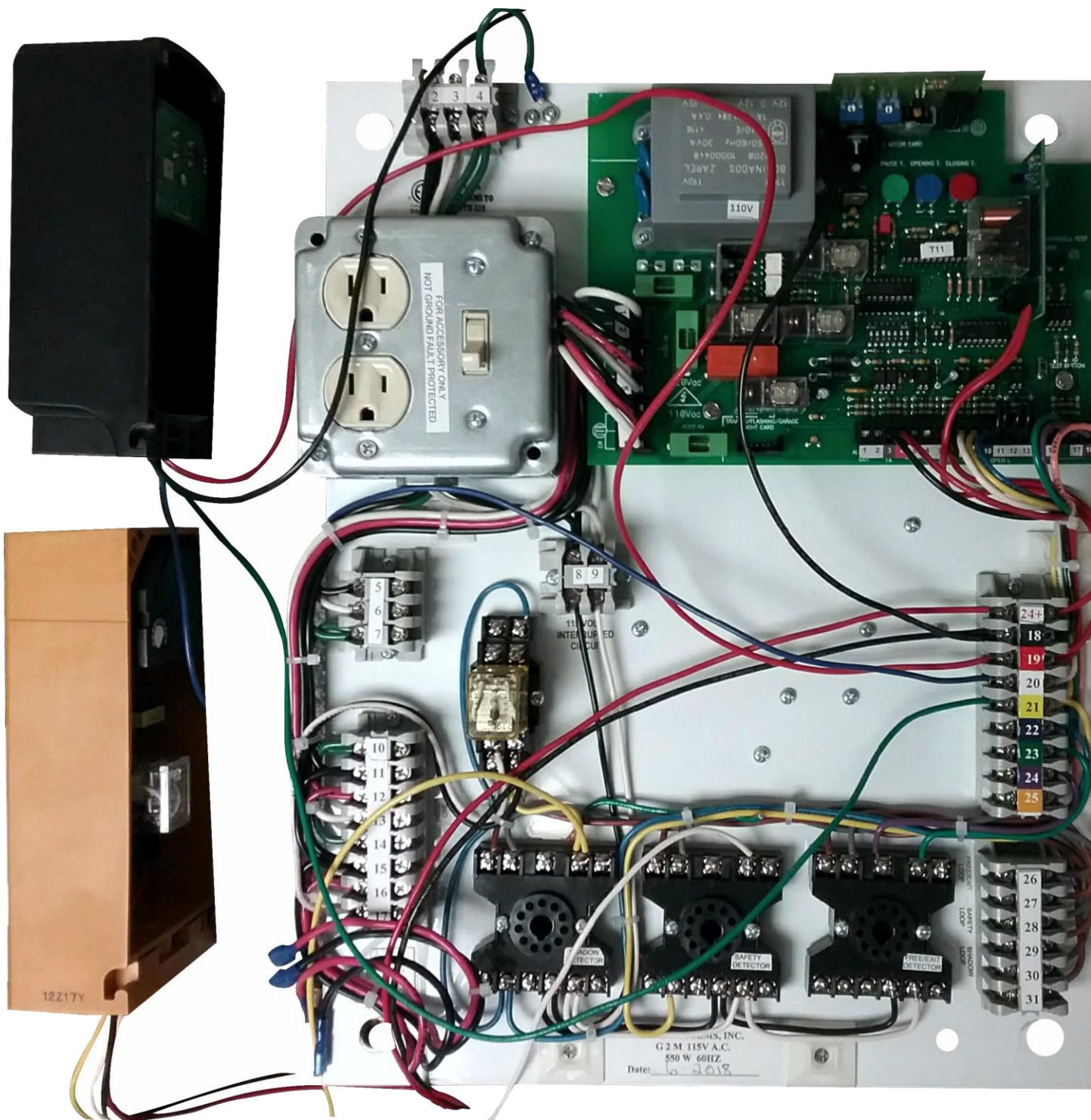

20x16 Prewired Enclosure with Safety & Free Exit Bases Wired to 2 Sets of Photobeams

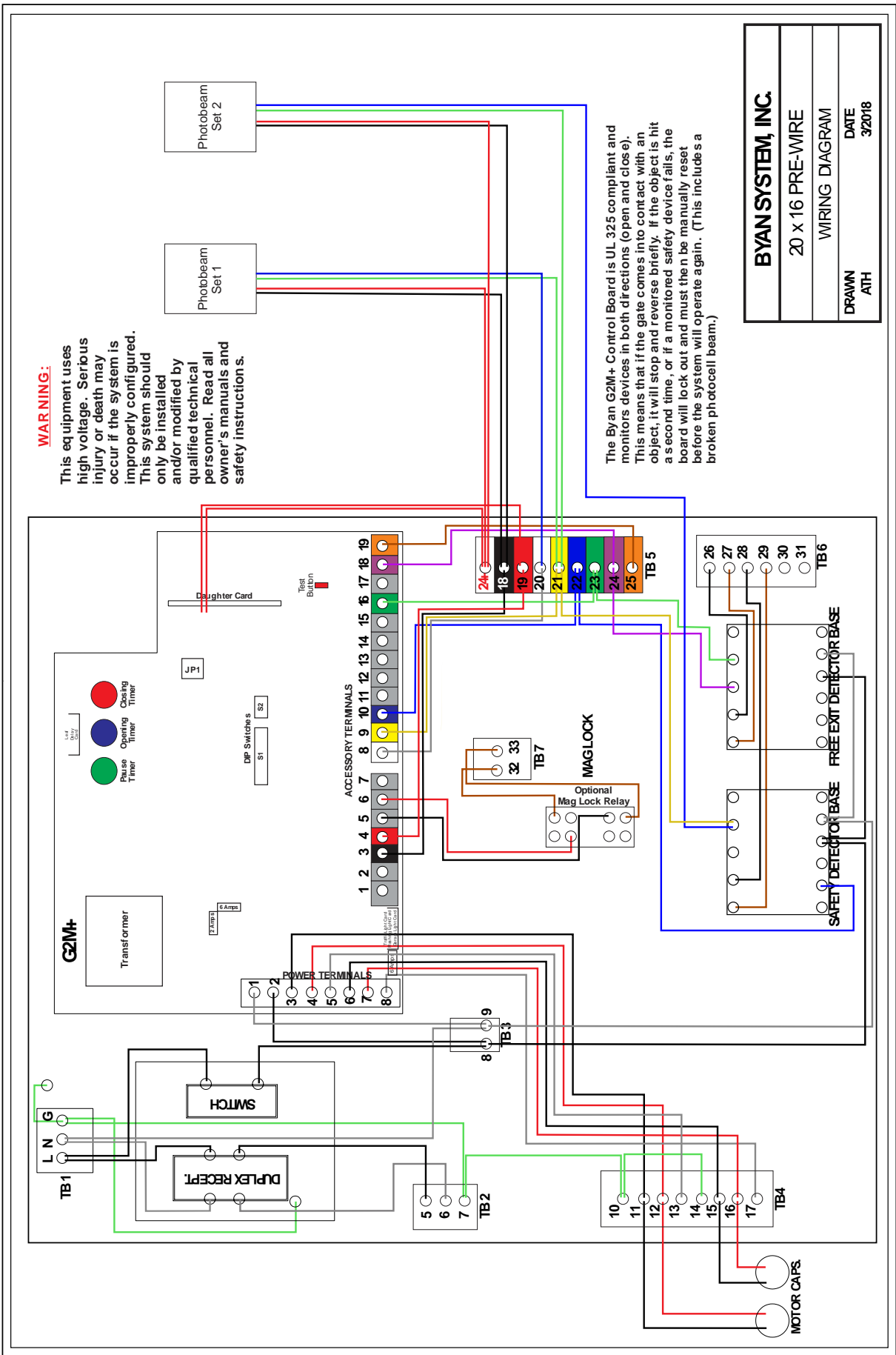

20x16 Prewired Enclosure with Shadow & Free Exit Bases Wired to 2 Sets of Photobeams

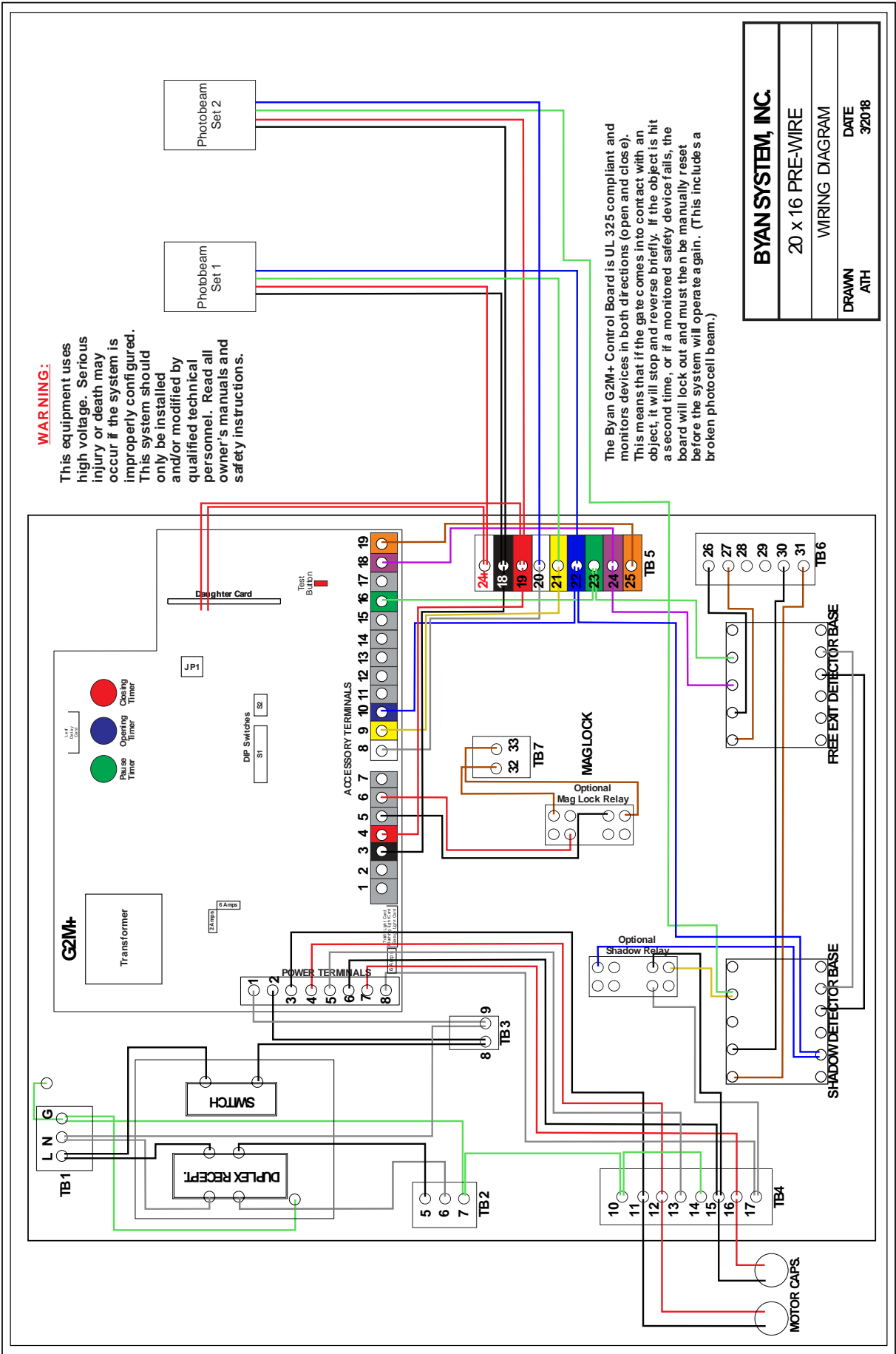

20x16 Prewired Enclosure with Shadow & Safety Bases Wired to 2 Sets of Photobeams

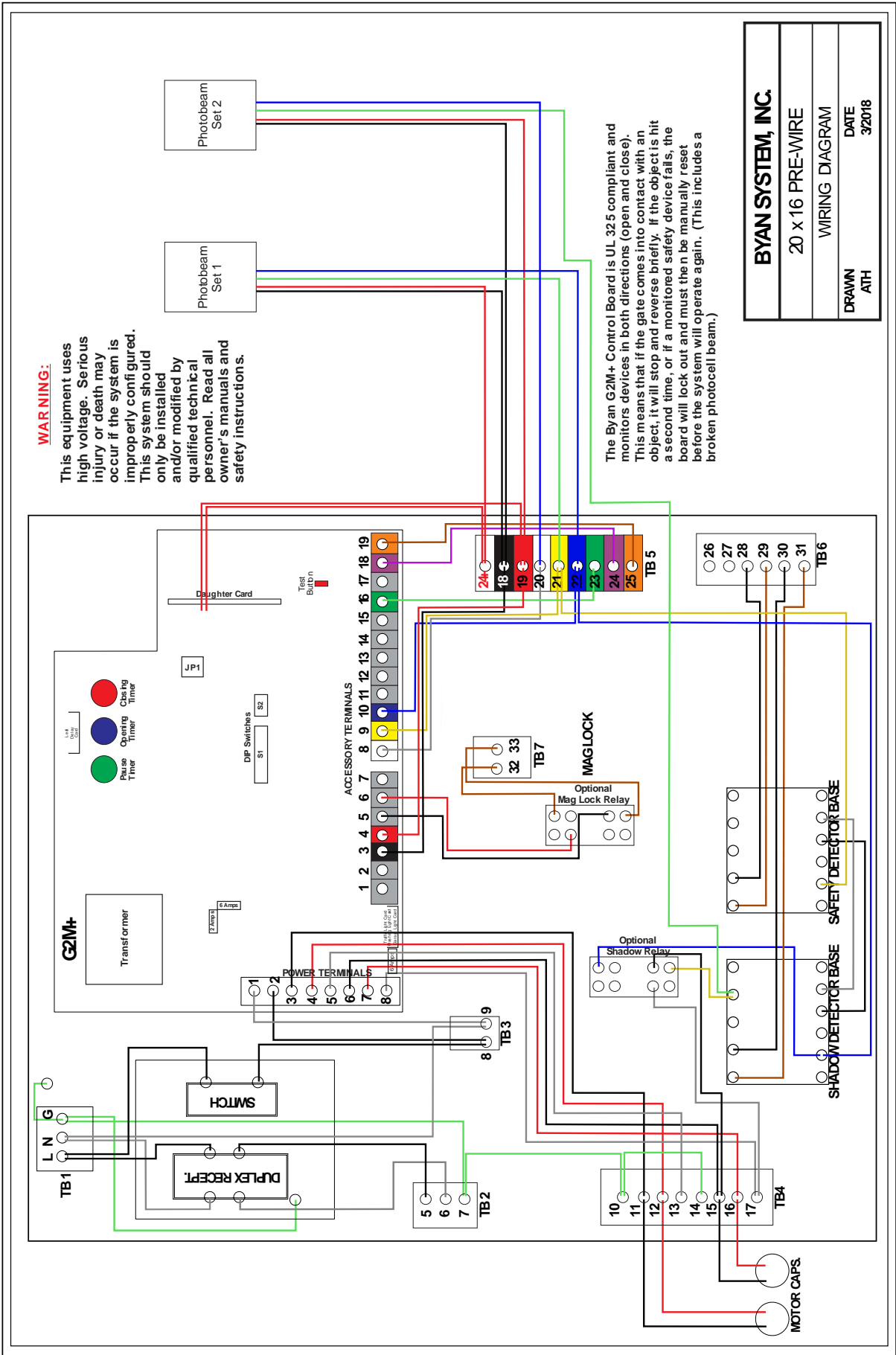

In this example, all accessories are wired as NORMALLY CLOSED on a BYAN SYSTEMS 3-base pre-wired backplate. (Accessories can be wired as either "car safe OR "people safe".) Only one accessory can be connected through Terminal #24+ on the pre-wired backplate. The second accessory will be connected to Terminals #18 and #19. (Accessories can be wired as either "car safe OR "people safe".)

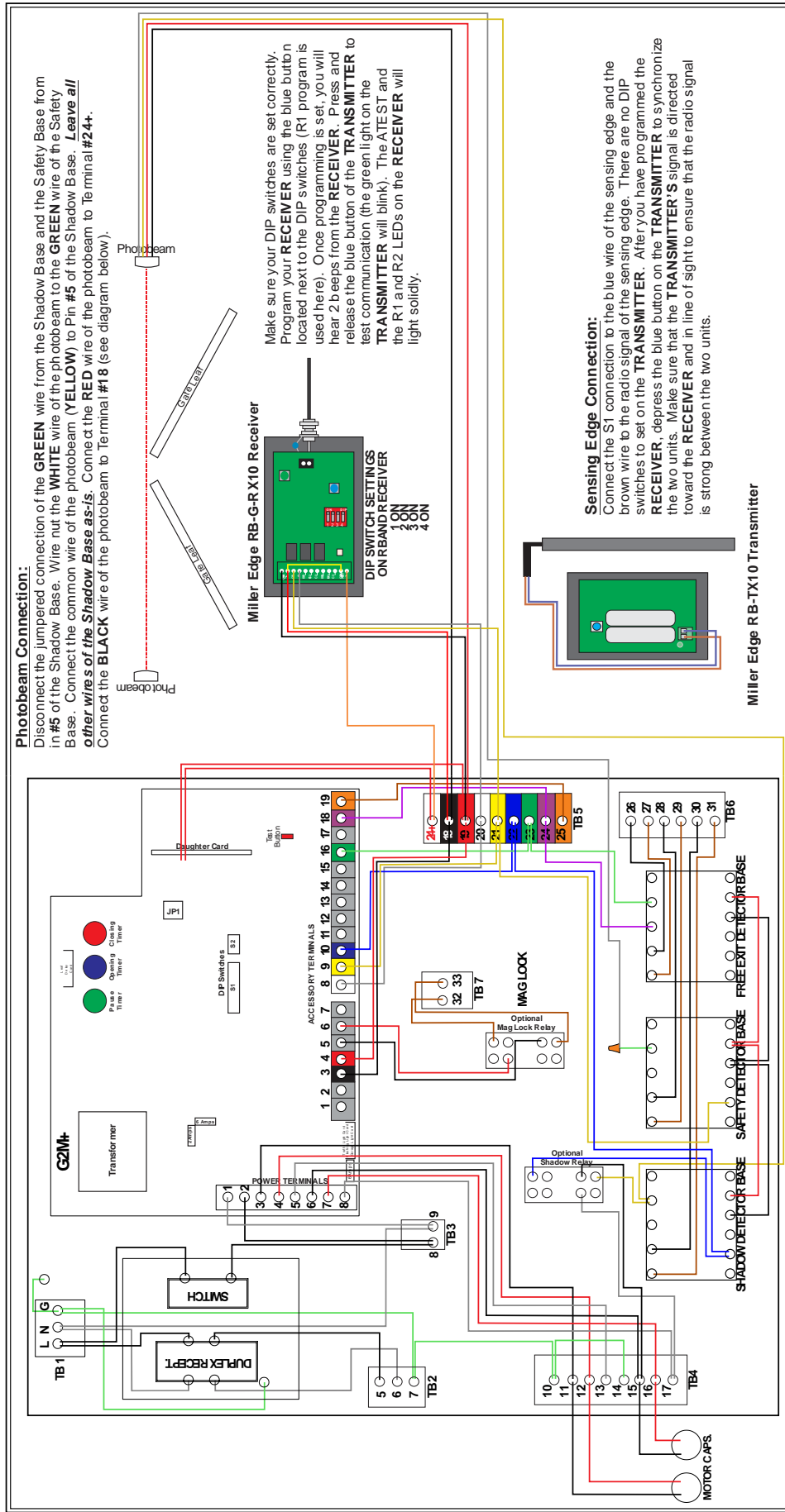

20x16 PRE-WIRED BACKBOARD WITH Transmitter SOLUTIONS RBAND IGAZEREKIT-UL SENSING EDGE AND PHOTOBEAMS

In this example, all accessories are wired as **NORMALLY CLOSED** on a BYAN SYSTEMS 3-base pre-wired backplate. Only one accessory can be connected through Terminal #24+ on the pre-wired backplate. The second accessory will be connected to Terminals #18 and #19. (Accessories can be wired as either "car safe" OR as "people safe".)

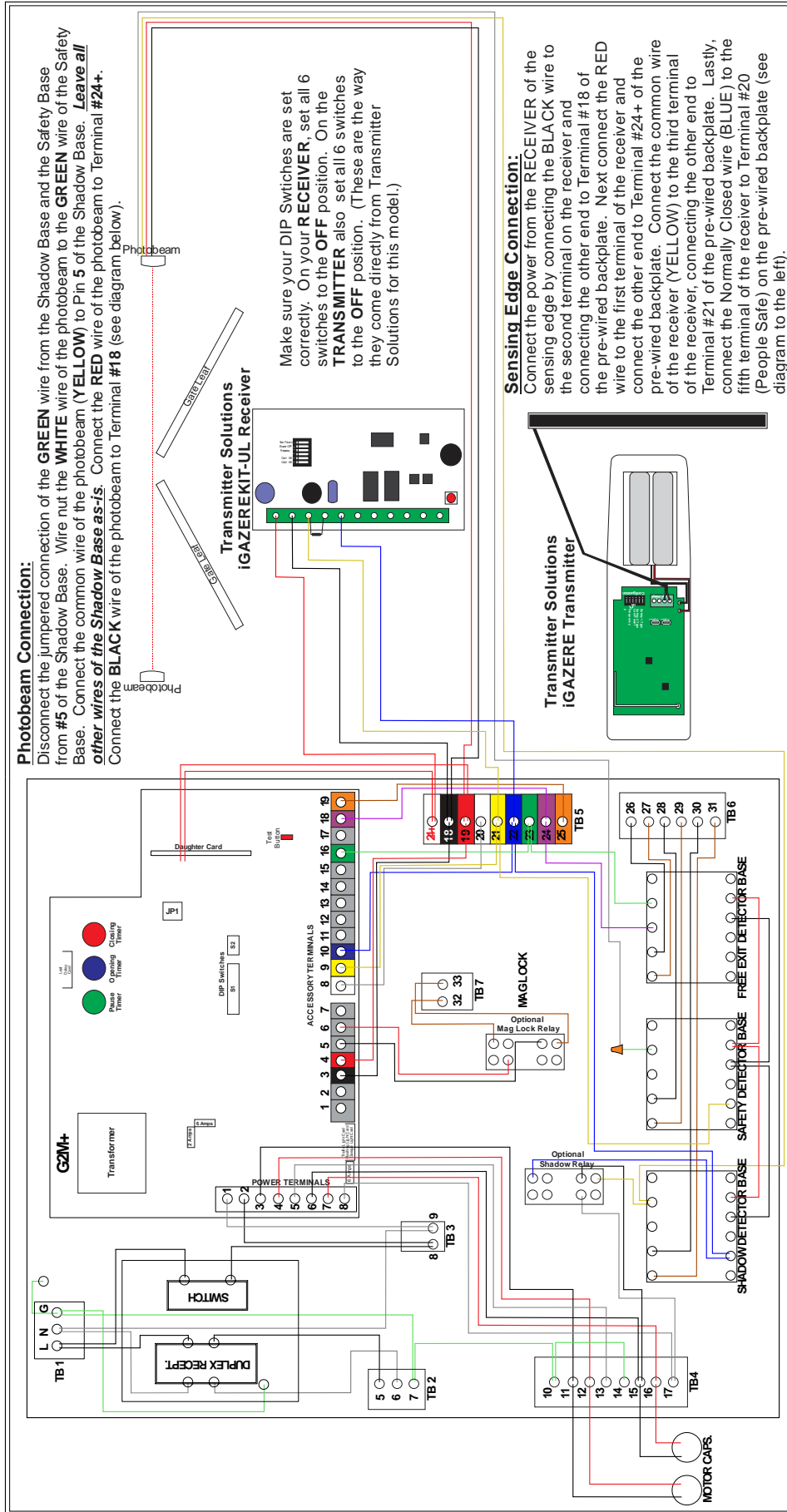

20x16 Prewired Enclosure with 24V DC Transformer

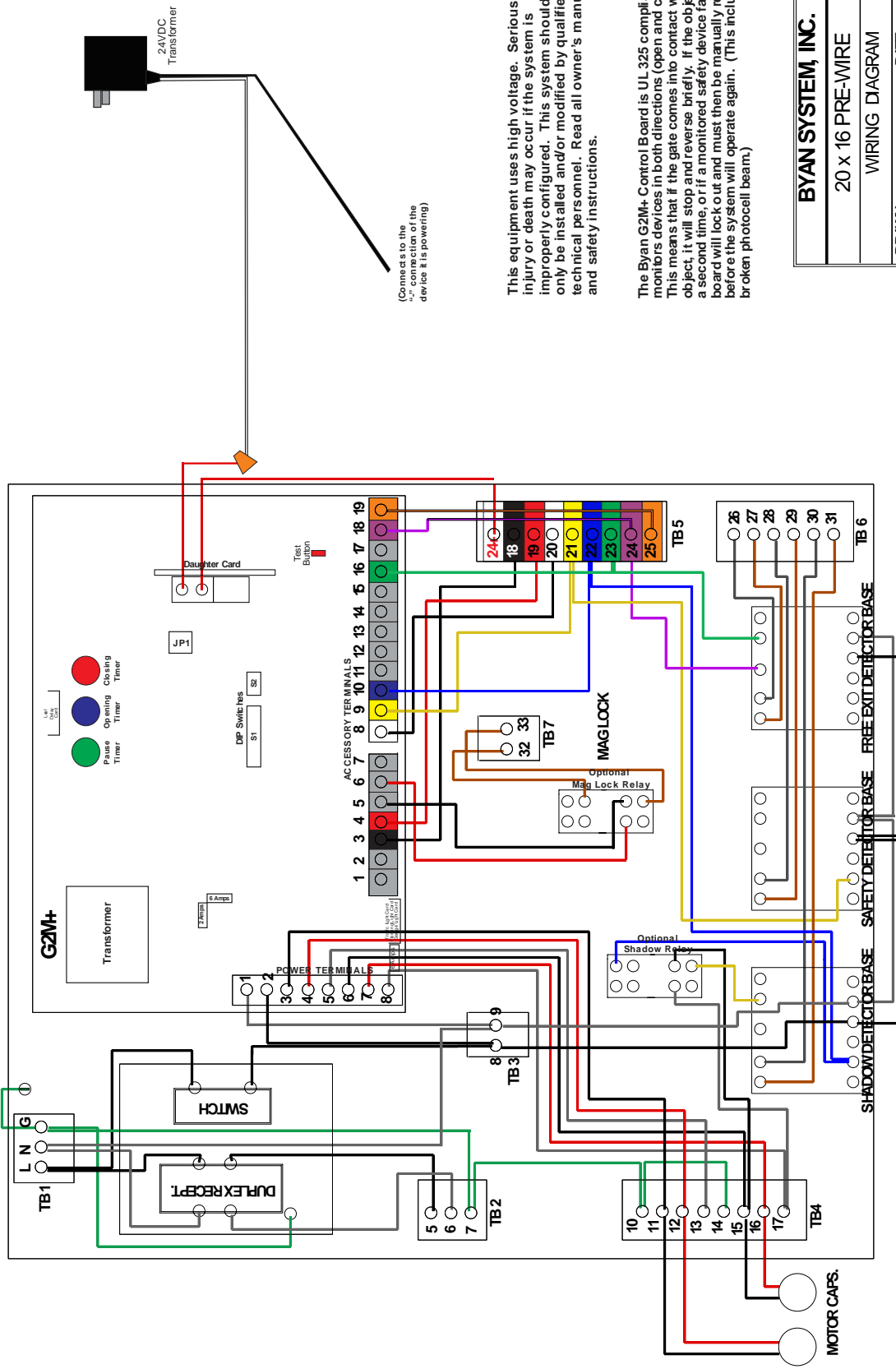

(Connects to the power source when the device is powering)

This equipment uses high voltage. Serious injury or death may occur if the system is improperly configured. This system should only be installed and/or modified by qualified technical personnel. Read all owner's manuals and safety instructions.

The Byan G2M+ Control Board is UL 325 compliant and monitors devices in both directions (open and close). This means that if the gate comes into contact with an object, it will stop and reverse briefly. If the object is hit a second time, or if a monitored safety device fails, the board will lock out and must then be manually reset before the system will operate again. (This includes a broken photocell beam.)

BYAN SYSTEM, INC.	
20 x 16 PRE-WIRE	DATE
WIRING DIAGRAM	32018
DRAWN	ATH

20x16 Prewired Enclosure with Shadow, Safety & Free Exit Bases Wired to 24VDC FAAC Transformer for use with 24VDC FAAC Photobeams

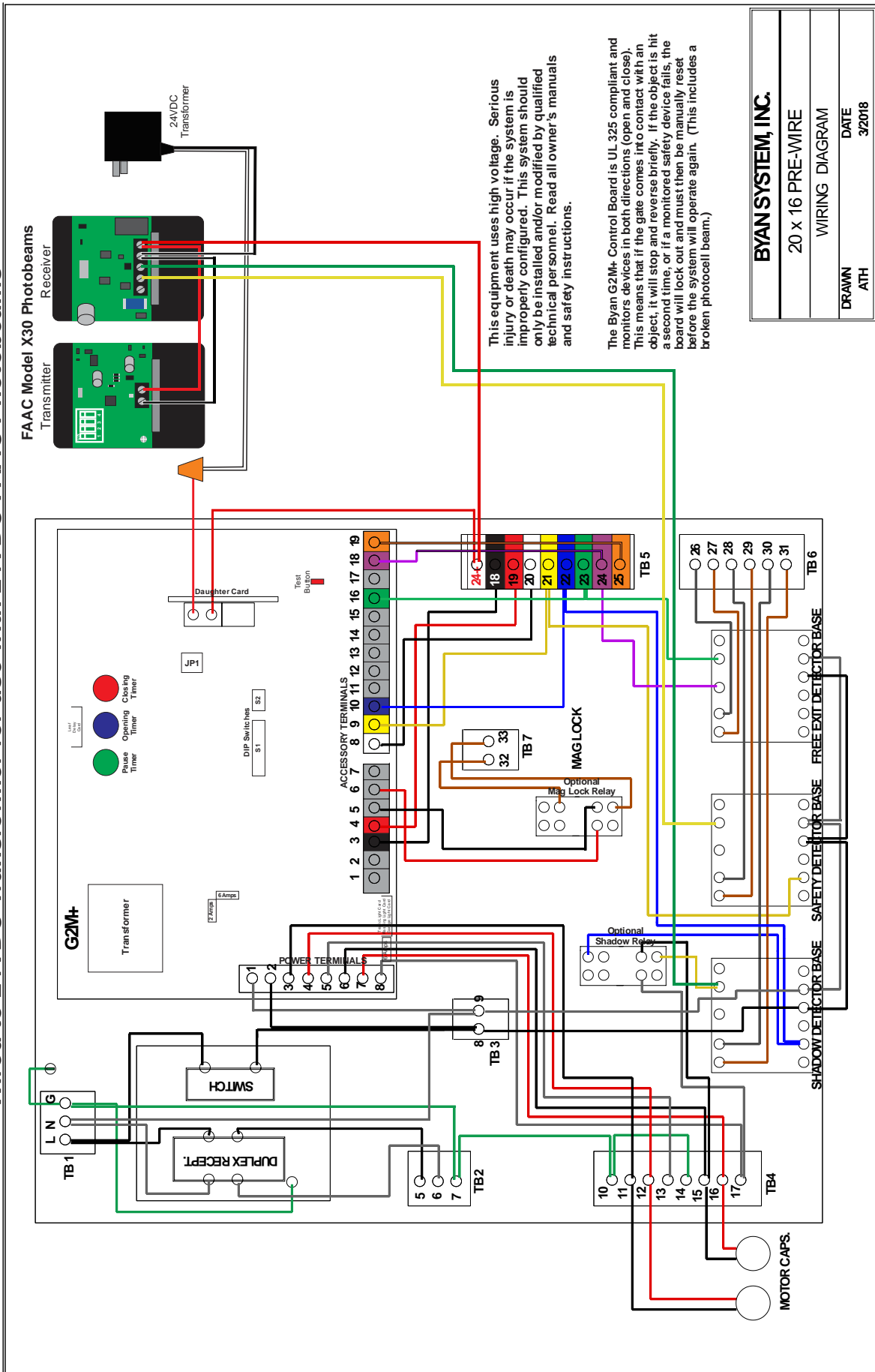

This equipment uses high voltage. Serious injury or death may occur if the system is improperly configured. This system should only be installed and/or modified by qualified technical personnel. Read all owner's manuals and safety instructions.

The Byan G2M+ Control Board is UL 325 compliant and monitors devices in both directions (open and close). This means that if the gate comes into contact with an object, it will stop and reverse briefly. If the object is hit a second time, or if a monitored safety device fails, the board will lock out and must then be manually reset before the system will operate again. (This includes a broken photocell beam.)

BYAN SYSTEM, INC.	
20 x 16 PRE-WIRE	
WIRING DIAGRAM	
DRAWN ATH	DATE 3/2018

20x16 Prewired Enclosure with Miller Edge GEM104 (To convert Normally Open connections to Normally Closed)

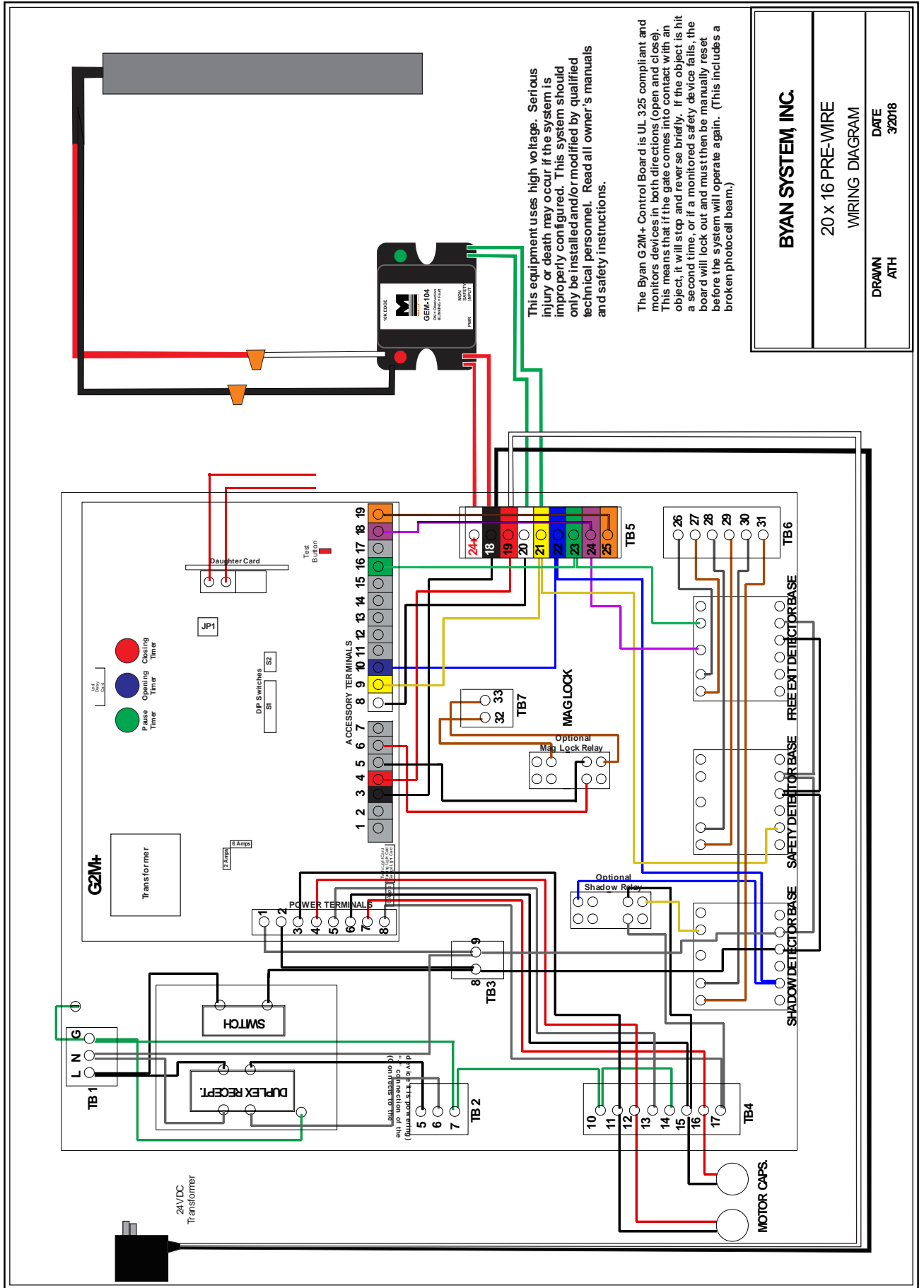

This equipment uses high voltage. Serious injury or death may occur if the system is improperly configured. This system should only be installed and/or modified by qualified technical personnel. Read all owner's manuals and safety instructions.

The Byan G2M+ Control Board is UL 325 compliant and monitors devices in both directions (open and close). This means that if the gate comes into contact with an object, it will stop and reverse briefly. If the object is hit a second time, or if a monitored safety device fails, the board will lock out and must then be manually reset before the system will operate again. (This includes a broken photocell beam.)

BYAN SYSTEM INC.	
20 x 16 PRE-WIRE	DRAWN ATH
WIRING DIAGRAM	DATE 3/2018

20x16 Prewired Enclosure with Linear GRD Receiver

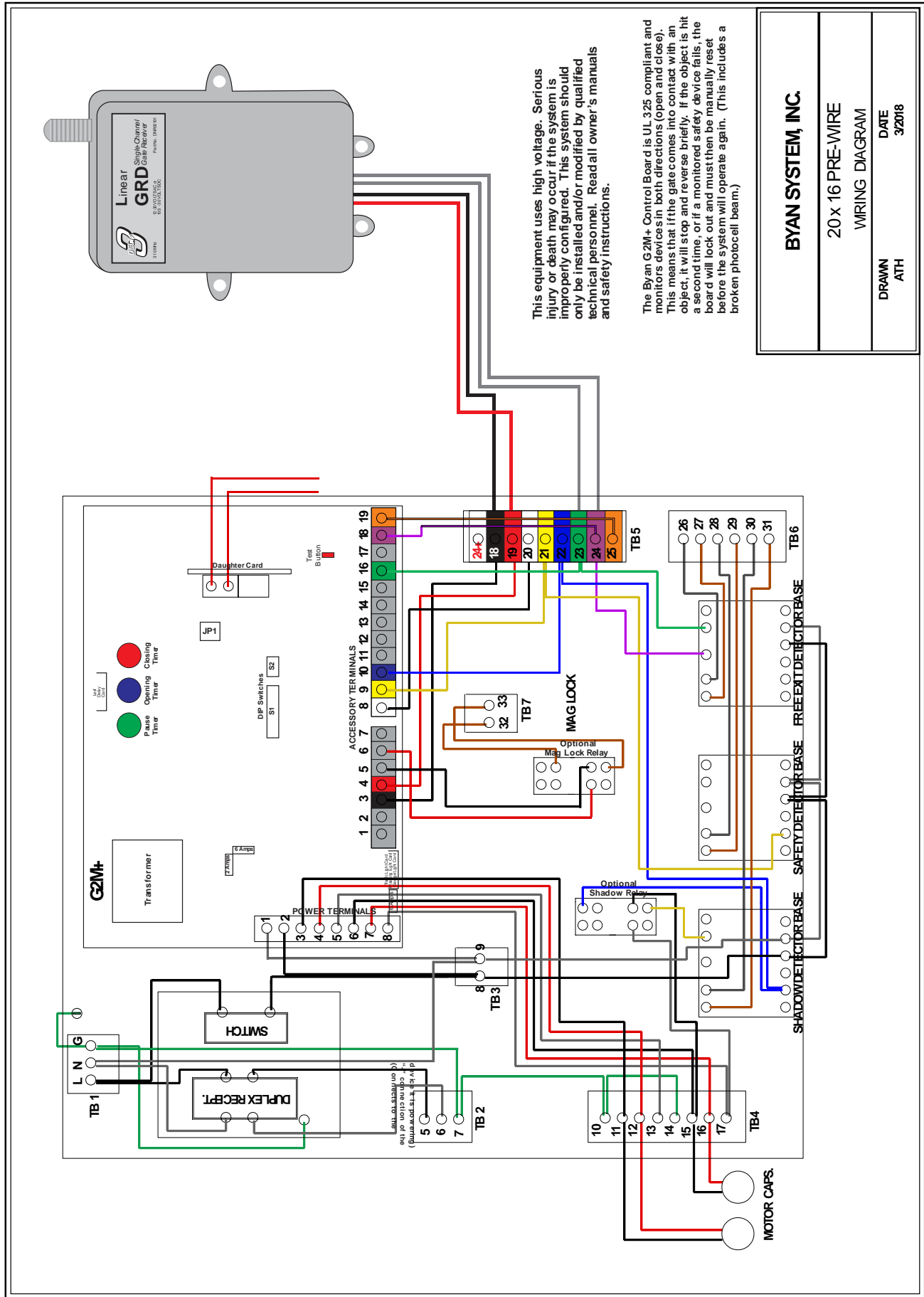

BYAN SYSTEM, INC.	
20x16 PRE-WIRE	
WIRING DIAGRAM	
DRAWN ATH	DATE 3/2018

Troubleshooting Guide:

Byan Systems recommends that **ALL** installations be preassembled **PRIOR** to installation on a job site to insure proper functioning.

Symptom	Possible Cause	Possible Solutions
Board will not power up	Power not connected; Switch in prewire not turned on; Board voltage is incorrect; Blown incoming power fuse	Ensure all connections are made and are tight (make sure that terminal block on pins 1 & 2 for high voltage are secure). Make sure the prewire switch is on. Make sure board voltage matches the incoming power. Check 2-Amp fuse on the G2M+ board.
Board is powered up but won't function	Jumper wires in accessory terminal are loose/missing; Safety device malfunctioning; Blown operator fuse	Check all jumper wires for location and make sure they are tight. Make sure safety devices are clear of obstruction and connected properly (the G2M+ uses Normally Closed safety contacts). Check 6-Amp fuses on the G2M+ board. Ensure that both of the Accessory Connection terminal blocks are secure (Pins 1-7 and 8-19).
Operators will not open or close fully	Timers not adjusted properly; Dip-switches are in the wrong position	Timers should be adjusted so operator pistons bottom out completely then run for an additional 3 to 5 seconds. Make sure all dip-switches are in the desired position and making good contact.
Operators run, but there is no piston movement	Capacitor bad or not hooked up; Bypass screw on operator backed out	Check that capacitors are hooked up. If one is suspect, switch capacitors and see if the problem follows the capacitor. Make sure the bypass screw is screwed in and snug.
Safety devices connected properly but not functioning properly	Jumpers in Terminals 8, 9 and 10 are still in; Safety device is malfunctioning	If Car Safe is used, make sure that the jumper between Accessory Terminals 9 and 10 is removed. For People Safe, remove jumper between Accessory Terminals 8 and 9. Make sure the safety device is connected and working properly.
Safety Device(s) only monitoring in the Close Function	DIP Switch 7 is in the OFF position	When turned on, car safety contacts are active during the open and close cycles. Input safety for vehicles only works on closing movement unless Switch 7 is set ON.
Radio receiver will only open the gate	Radio receiver is wired incorrectly	If the receiver is to be used as a reversing device, it must be wired across Accessory Terminals 16 and 19.
Free exit probe not working	Probe is malfunctioning; Probe is wired incorrectly	Make sure probe is working properly and is connected correctly. The probe's Normally Open contacts must be connected across Accessory Terminals 16 and 18. If the probe uses 24-Volt AC for power, it can be connected to Accessory Terminals 3 and 4.
Operators running the wrong direction	Directional wires switched	Reverse the black and red directional wires either at the operator or at the board.

If, at any time, you have a question concerning the Byan Systems G2M+ control board, call (800) 223-2926 for technical support.

T2M Leaf Delay Card

Description:

The T2M Leaf Delay Card will control the opening and closing of the second leaf in a two-leaf gate system. With the card installed and the potentiometers adjusted, the first gate leaf will open first followed by the second when an **OPEN** command is issued. When a **CLOSE** command is issued, the second leaf will close first followed by the first leaf. There are two adjustable potentiometers on the card. The Open Delay Timer sets the delay between the opening of the first leaf and the opening of the second leaf. The Close Delay timer sets the delay between the closing of the second leaf and the closing of the first leaf. There are also inputs on the card for Open and Close Limit switches for the second leaf, if limit switches are required.

Adjustable Timers:

Timer Description	Minimum Delay	Maximum Delay
Open Timer (Left)	0 Seconds	15 Seconds
Close Timer (Right)	0 Seconds	15 Seconds

Board Terminals:

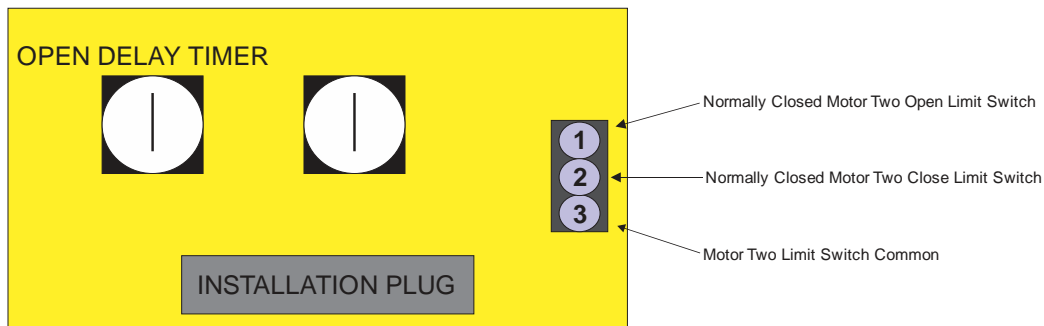

Installation Instructions:

To install the leaf delay card, simply plug it into the card slot marked "2 Motor Card" on the G2M+ Control Board.

Adjustment Procedure:

1. **To set the amount of delay between the first leaf opening and the second leaf opening**, turn the Open Delay Timer (left timer) with a small screwdriver. To increase the open delay, turn the timer counter-clockwise. To decrease the open delay, turn the delay timer clockwise.
2. **To set the amount of delay between the second leaf closing and the first leaf closing**, turn the Close Delay Timer (right timer) with a small screwdriver. To increase the close delay, turn the timer counter-clockwise. To decrease the close delay, turn the timer clockwise.

DAUGHTER CARD HOOKUPS

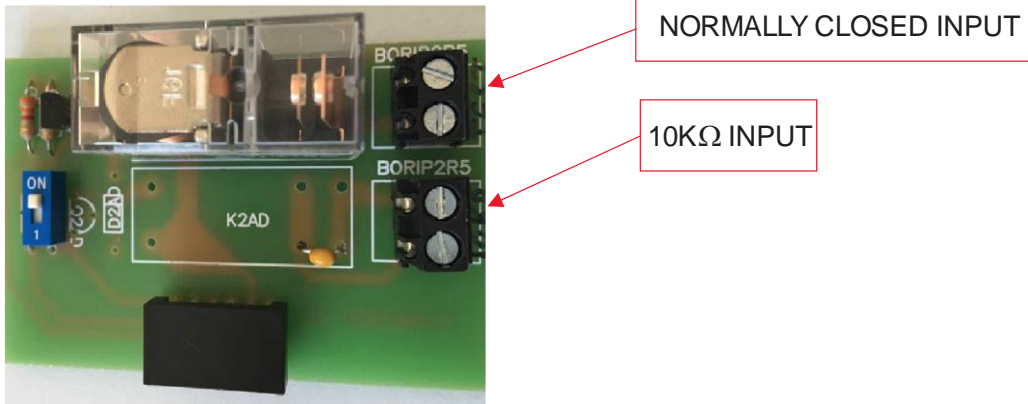

To operate the control panel, the micro switch that is on the daughter card must be set in the ON position and after any changes are made to the state of the safety devices in the system, **it must be reset by turning the switch OFF and ON again**. After a 3 to 4 second wait, the MP panel will be ready to function fully again.

CONNECTIONS:

NORMALLY CLOSED MONITORED

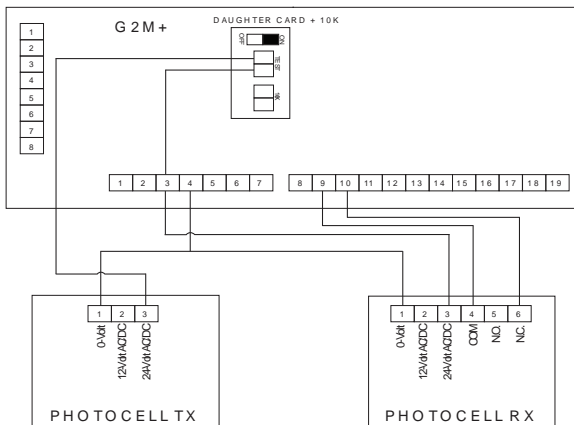

10KΩ

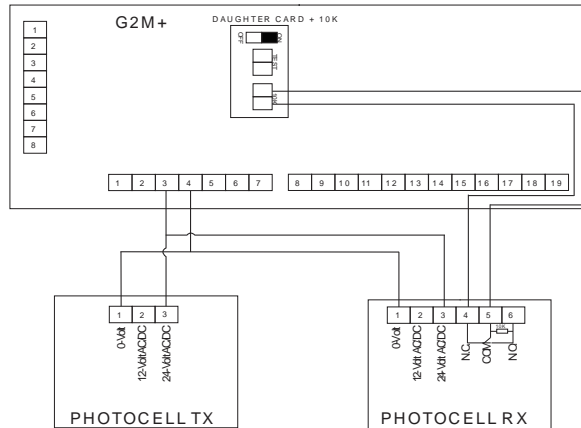

NORMALLY CLOSED MONITORED

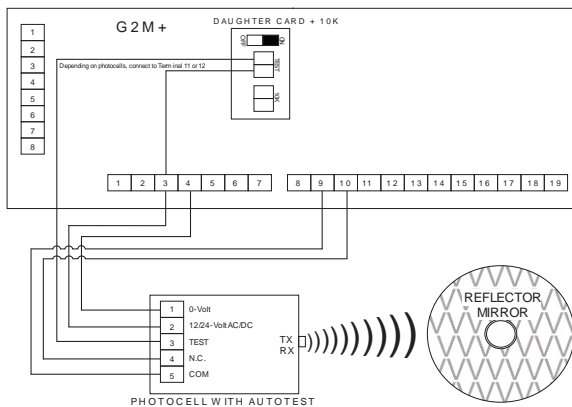

10KΩ

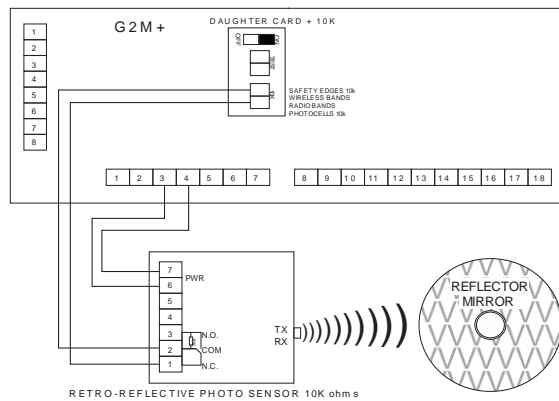

The opening and closing commands can be performed by using the reverse button or by radio control. The opening/closing operation ends by timing or by the open/close limit switch. If the reverse button is activated during the operation of the unit, the door stops. **There is no automatic closing time and the next operation (if the reverse button is activated) will close.** If the reverse button is used during the closing operation, the door will stop and it will open if the Switch 2 is set to OFF. If the Switch 2 is in the **ON** position, the door remains paused until a new activation of the reverse button is programmed.

The Safe Cars Input (normally connected to a photocell) acts in the closing operation by reversing the operation. The door stops and then re-opens. In the opening operation, the Safe Cars Input acts by stopping the door only if Switch 7 is set in the **ON** position.

If the People Safe input is used, it is activated when the door is moving. The door stops and reverses its movement for two seconds. If the People Safe input remains active, the alarm relay is activated and the door is paused until the reset alarm is activated. If the alarm is not active, the next operation is to continue the interrupted operation.

The stop button interrupts and stops the door in any operation and it is necessary to activate the reverse button to continue the operation of the door.

TECHNICAL OPERATING CHARACTERISTICS	
Supply Voltage	220-Volt AC ±10% 110-Volt AC ±10%
Frequency	50-60 Hz
Maximum Power on Motor Output	¼ HP
Available Power on Accessories Output	24-Volt AC 1-Amp
Maximum Load on Electric Lock Output	12-Volt AC 1-Amp
Maximum Power Absorption (excluding motors, lights and external loads)	80mA at 220-Volts 160mA at 110-Volts
Automatic Closing Time	5 Seconds to 2 Minutes
Opening and Closing Time (Normal)	5 Seconds to 1 Minute
Opening and Closing Time (x2)	1 Minute to 2 Minutes
Radio Control Card	Optional
Second Motor Card	Optional
Flashing Card	Optional
Temperature Range	-40°F to 185°F

LOOP DETECTOR CONNECTIONS

The Mollex connector has 11 wire leads which are each 12 inches long. The pin-out is as follows:

RED	Power B+
BLACK	Power B-
BLUE	Relay A Common (pulse or presence)
ORANGE	Relay a Normally Closed (pulse or presence)
YELLOW	Relay A Normally Open (pulse or presence)
GREEN	Relay B Common (pulse only)
PURPLE	Relay B Normally Open (pulse only)
BROWN	Loop Wire
GRAY	Loop Wire
WHITE	Not Used

NOTE: Leader wire from the loop, whether it is pre-formed or manufactured on the installation site, **MUST** be twisted a minimum of five turns per foot.

THE PROPER LOOP WIRE

Why is the loop wire so important?

One of the main causes of vehicle loop detector failures is the use of inferior wire types when constructing the loop. Since moisture can cause a significant change in the dielectric constant of the insulation, which results in excessive loop (frequency) drift, you must choose the wire with an insulation that is most impervious to moisture. It is also important to choose a wire with a rugged, abrasion resistant insulation. Remember that all pavements are porous and contain trapped moisture. Water or other chemicals will eventually reach the insulation and either attack the insulation, be absorbed by it, or migrate through tiny cracks in the insulation and change the dielectric or break down the insulation and cause shorts to ground.

What about the wire?

Polyvinyl chloride (PVC) insulation (TFFN, THHN, and THHN-THWN) should be avoided since it tends to absorb moisture and cracks very easily. The insulation is thin and very soft, leaving it vulnerable to damage during installation and rapid age cracking after sealing. Any one of the above-mentioned wire types has only 0.015 inch of insulation from 12 gauge to 18 gauge. If there is any doubt about its vulnerability, crimp the insulation with a pair of pliers and see how it cracks. See how easily it strips with a pocketknife. What would an unnoticed piece of wire or a shard of glass buried in the pavement slot do to the insulation? The outer diameter is 0.115 inch for 14 gauge wire and 0.013 inch for 16 gauge wire. When installed in a 0.25 inch slot and the turns twist under the preceding turns and not stack snugly in a single layer, as they should be. This will cause reduced loop efficiency.

What type of wire should I use?

Cross-linked polyethylene (XLPE) or polyester insulation provides excellent protection for wire used in saw cut loop installations. Both types are abrasion resistant, much harder (though not impossible) to strip, and very moisture resistant.

SUMMARY:

The use of the correct type of wire for the installation, as well as the proper installation techniques, will avoid frequent service calls beginning soon after installation and will result in years of trouble-free service and in customer satisfaction.

COMPARISON CHART

Insulation Type

Resistance to Chemicals/Environment	XLPE	THHN
Ethyl Alcohol	High	Good
Acetone	High	Good
Gasoline	High	Fair
Physical Conditions		
Abrasion Resistance	E	F-G
Degreaser Solvent	E	P-F
Low Temperature Flexibility	E	P-F
Electrical	F-O	F-G
Water Absorbency (% in 24 Hours)	0.01%	0.75%
Service Temperature Range	-85°F to 300°F	-67°F to 221°F

P=Poor

F=Fair

G=Good

E=Excellent

O=Outstanding

LOOP CONFIGURATION

The following relationship between loop area (loop width multiplied by loop length) and the number of turns for a single loop installation should be satisfied as follows:

LOOP AREA (Square Feet)	Number of Turns
6-10	6
10-18	5
18-60	4
60-240	3
240 Up	2

LOOP DETAILS

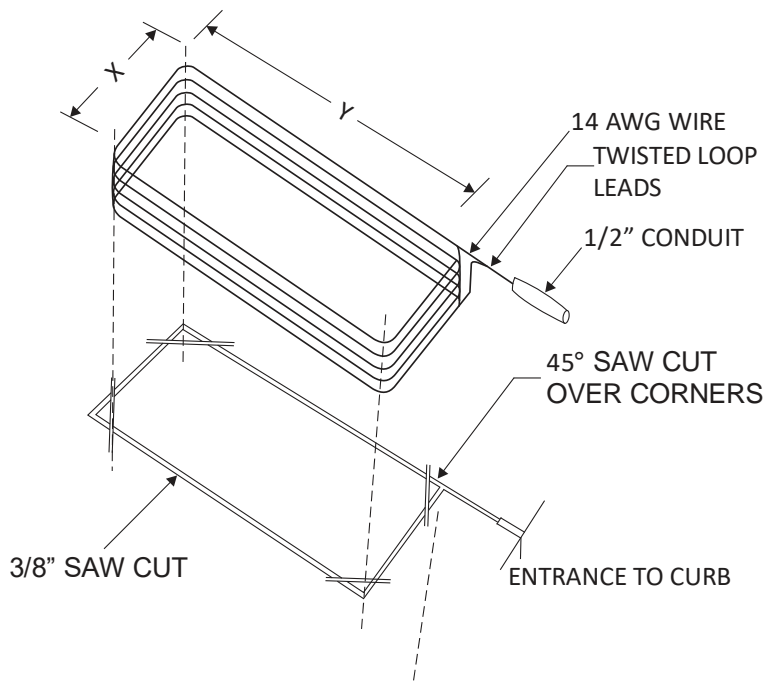

1. The saw slots must be the proper depth (1-1/2 to 3 inches), clean, and with no sharp corners which could damage the insulation during installation. The greater depth should be used in softer pavement materials to protect the loop installation for a longer period of time.
2. The wire used in the loop should be 14 AWG stranded with insulation rated for direct burial. Since moisture can cause significant changes in the dielectric constant of the insulation, which results in excessive loop (frequency) drift. Choose an insulation which is most impervious to moisture. The loop must be wound with one continuous length of wire. **NO SPLICES ARE ALLOWED.**

3. Where the loop wires leave the saw cut (at the curb or pavement), they shall be tightly twisted with a minimum of five (5) turns per foot. Use tape on the twisted portion to hold wires tightly together. This will prevent false signals from the movement between wires.
4. Choose a sealant carefully to match the application and the pavement. Hard setting epoxies should not be used with asphalt. Caution should be observed when using hot sealants, as high temperature can damage or destroy wire insulation.

WARNING

1. DO NOT INSTALL LOOP WITHIN 12 INCHES OF ALL POWER CONDUITS OR CABLE
2. STEEL REINFORCING MUST BE KEPT A MINIMUM OF 2 INCHES FROM LOOP LOCATION

RECOMMENDED PLACEMENT OF SAFETY EDGES AND PHOTOBEAMS

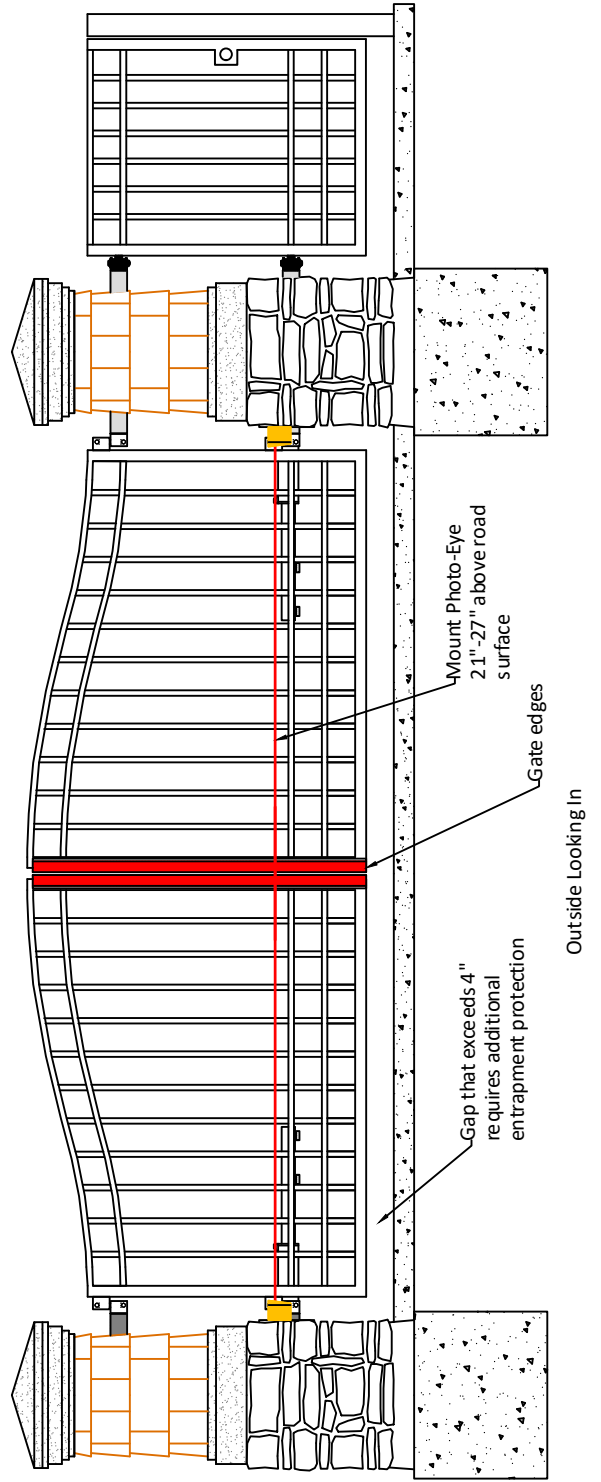
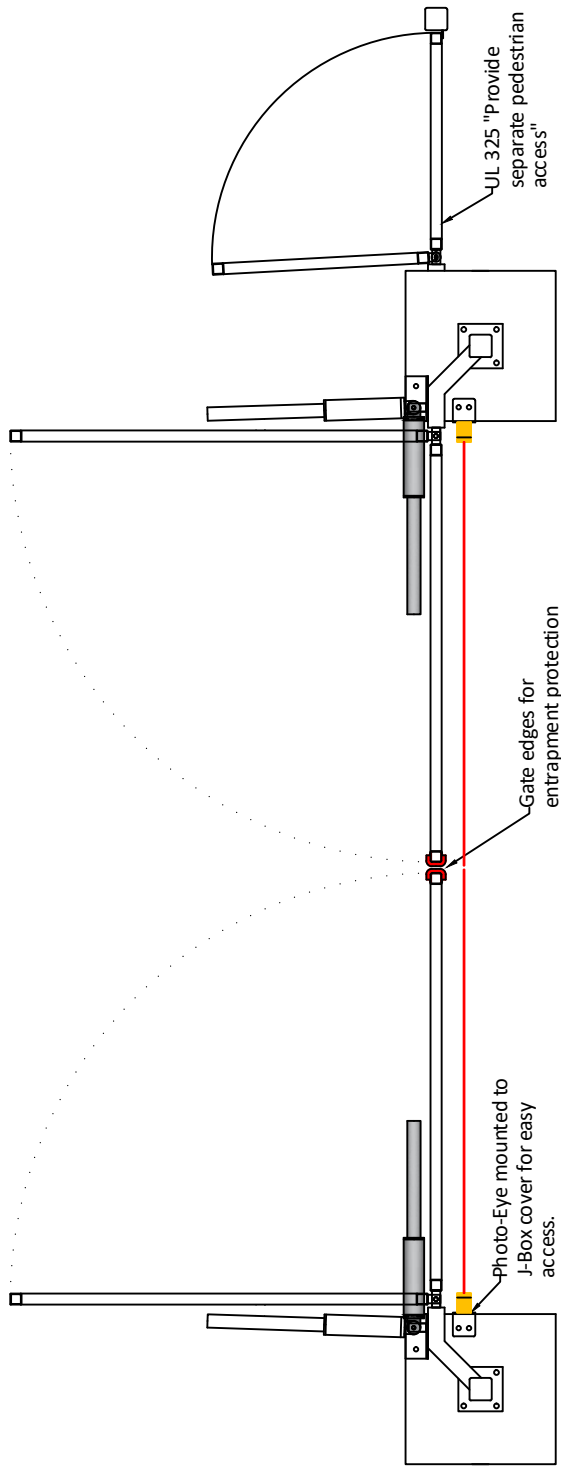

END USER SAFETY

Byan Systems, Inc. has no control over the gate system you have automated. The word “system” herein refers to the gate post, gate leaf(s), hinging, all automation equipment, accessory devices, the construction and installation thereof.

Vehicular gate operating systems provide convenience and security to their users. Because these machines produce such high levels of force, all gate system designers, installers and end users must be aware of the potential hazards associated with improperly designed, installed or maintained systems.

Each component must work in unison to provide the end user, visitors and subsequent owners with proper operation of all automation, safety and access control equipment.

It is the responsibility of the designer, installer and purchaser that the total system is safe for the particular application.

The end user’s responsibility is always present. Assurance of safety rests with the user of the gate system at any particular time.

Gate systems should be protected, as may be necessary, from children and pets by whatever means necessary. Moving devices always present people, pets and property with certain risks and have potential for harm.

The following list of precautions has been prepared for your review. This list is not all-inclusive, nor is it represented as such. Please ask your installer any questions you have now, or later, about the installation, operation, or safety features of your gate system.

1. Be sure the operating and safety instructions are available to all persons that will operate the gate system.
2. Keep gate system operating area clear of all obstructions. Stay clear of the operating area when the gate system is in use.
3. Do not allow children or pets near the gate system. In a residential or multi-family dwelling, it may be necessary to fence off portions of the system. It may be necessary to mount protection devices in the area, on the gate, or the equipment itself.
4. **CAUTION!!** Never allow children to ride on the gate(s) or play around the electrical enclosures.
5. Never operate a gate system without visual contact so that operation may be suspended if necessary.

6. Secure and label power cabinets and/or equipment covers.
7. If the gate has an open roller, each must have a guard suitable to protect persons, pets and clothing from being entrapped, no matter how unlikely it may appear at first glance.
8. Ensure all safety devices are tested regularly.
9. Do not tighten clutches or increase pressures to compensate for a poor gate system design and/or the gate leaf.
10. Install warning signs on both sides of the gate leaf.
11. Have proper lighting installed for nighttime use.
12. Never become complacent with the operation of a gate system. Schedule periodic inspections and/or maintenance.

WARNING

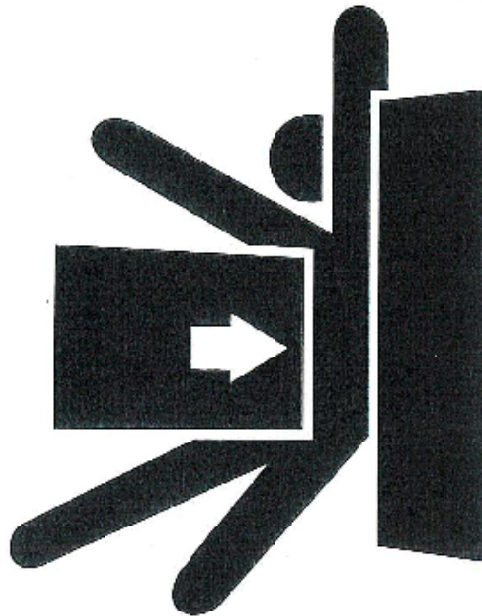

Moving Gate Can Cause Serious Injury or Death.

KEEP CLEAR! Gate may move at any time without warning.

Do not allow children to operate the gate or play in the gate area.

This gate is for vehicles only. All pedestrians must use a separate entrance.

Read owner's manual and safety instructions.

If entrapment protection is by constant hold control, an automatic closing device shall not be used with this gate operator.

BYAN SYSTEMS, INC.

FIVE YEAR LIMITED WARRANTY

This warranty pertains only to products manufactured for or by **BYAN SYSTEMS, INC.** for gate operating systems, accessories, and equipment. These products are warranted against all defective material for sixty months from the date of sale.

Defective material returned must be prepaid and accompanied by a **BYAN SYSTEMS, INC.** return authorization number within the warranty period for repair or replacement at the discretion of **BYAN SYSTEMS, INC.** **BYAN SYSTEMS, INC.** will return warranted item freight prepaid ground service via U.P.S.

This warranty extends only to wholesale customers who buy direct from **BYAN SYSTEMS, INC.** through normal distributor channels. **BYAN SYSTEMS, INC.** does not warranty its products to the end user/consumer. Consumers should inquire from their selling dealer as to the nature and extent of the dealer's warranty, if any. There are no obligations or liabilities on the part of **BYAN SYSTEMS, INC.** for consequential damages arising out of, or in connection with, the use or performance of these products or other indirect damages with respect to loss of property, revenue or profit, cost of removal, original installation or reinstallation.

Warranty will be considered void if damage or malfunction was due to improper, inadequate and/or negligent installation or the use of improper power source, or if the damage was caused by fire, flood, lightning, electrical power surge, explosion, windstorm or hail, aircraft or vehicles, vandalism, riot or civil commotion, or acts of God. All implied warranties for fitness are limited in duration to sixty months from date of sale by **BYAN SYSTEMS, INC.** Some states do not allow for the length of the term of this implied warranty, so this limitation may not apply to you. This warranty by **BYAN SYSTEMS, INC.** is in lieu of all warranties expressed or implied.

Product delivery time is subject to availability. **BYAN SYSTEMS, INC.** is not responsible for any damages caused by delays in shipping or product availability.

Safety Accessories Compatible and Tested with Byan Systems Products:

Photobeams:

Manufacturer	Model
EMX	IRB-RET Photobeams
Miller Edge	Reflecti-Guard #RG Reflective Photobeams
Miller Edge	Prime-Guard #PG Through-beam Photobeams
Omeron	E3K-R10K4 Through-beam Photobeams
Seco-LARM	Enforcer E960-D90Gq Through-beam Photobeams
Transmitter Solutions	iGAZER66HD Through-beam Photobeams
Transmitter Solutions	iGAZER32P-UL Reflective Photobeams
Transmitter Solutions	iGAZER32P-UL Reflective Photobeams

Sensing Edges:

Manufacturer	Model
Miller Edge	RBand RB-G-K10 Sensing Edge Receiver/Transmitter
Miller Edge	MGS20 Sensing Edge (2 and 4 wire)
Miller Edge	ME110 Sensing Edge (2 and 4 wire)
Miller Edge	ME123 Sensing Edge (2 and 5 Wire)
Miller Edge	GEM-104 Interface Module (converts Normally Open connections to Normally Closed)
Transmitter Solutions	RBand iGAZERKIT-UL Sensing Edge Receiver/Transmitter

CUSTOMER ACKNOWLEDGEMENT

Dear _____
(Customer/Company Name)

Vehicular gate operating systems provide convenience and security to their users. Because these machines produce such high levels of force, all gate operating system designers, installers and end users need to be aware of the potential hazards associated with improperly designed, installed or maintained systems.

Each component must work in unison to provide their end users, visitors and subsequent owners with convenience, security and safety.

Byan Systems, Inc. operators and accessory equipment are intended to be part of a total operating system. We highly endorse and recommend the use of safety accessories and visual warning indicators in the form of lights, sounders and placards properly placed.

It is the responsibility of the purchaser, designer and installer that the total system is safe for the particular application.

We are pleased you have selected Byan Systems operators for your vehicular gate automation. On behalf of our distribution and dealer network, may I extend to you our gratitude and commitment to future support.

Thank you for reviewing this information. Verify with your installer that you understand all of the operating equipment and the functions of the safety accessories.

Please sign and date this form acknowledging you have read, understand and ratify the information herein.

X _____

Date: _____