

FLOOR-TO-CEILING WINE RACK



FLOOR-TO-CEILING WINE RACK

RECOMMENDED TOOLS: Tape measure, Level, Pencil, Electrical drill, Stud finder, Hammer, and Clamps

PACKAGE CONTENTS

2 Floor-To-Ceiling frames (Top + Bottom)

Screws

INSTALLATION STEPS

IMPORTANT: When securing the FTC to a location, use the appropriate mounting fasteners. There are 4 fastener locations on the top and bottom brackets.

STEP 1: MARK SCREW HOLES

Mark the screw holes for the mounting brackets in the desired mounting location.

STEP 2: MEASURE CEILING HEIGHT

Measure the ceiling height in the location you will mount the frame.

STEP 3: MAKE CALCULATIONS

Calculate the height of your ceiling, then subtract the height of the top frame to give you the measurements for your bottom rail.

STEP 4: MARK BOTTOM FRAME

Mark the bottom frame to determine the cut location.

STEP 5: CUT FRAME

Cut the frame in marked location using a metal-cutting hack saw.

Note: Do not use a metal cut off wheel as the heat will damage the product.

STEP 6: CONNECT THE TOP AND BOTTOM FRAMES

Drill holes on the bottom frame, and then use the hardware to connect the TOP and BOTTOM frames. Ensure that the holes for the TOP and BOTTOM frames are lined up in the desired location.

PRO TIP: Pre-drill holes before installing the Floor-to-Ceiling mount.

STEP 7: MOUNT BRACKETS

Mount the brackets to the ceiling then the floor using the appropriate anchors.

Do not over-tighten.

STEP 8: MOUNT RAILS

Mount rails to frame. Use all mounting holes to fasten rails securely.

PRO TIP: Use clamps to hold rails in place while mounting.

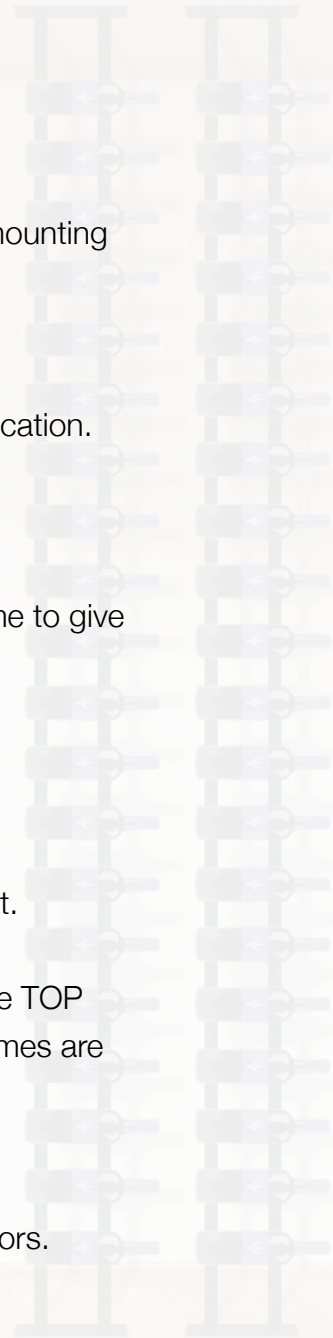

FLOOR-TO-CEILING WINE RACK

(1-Bottle depth 24 Bottles)

A x 4		Metal Rails			
C x 1	D x 1	B x 24		Wine Pegs	
				E x 4	
		F x 4	G x 4	H x 4	I x 8
1		2			
<p>1-Bottle Depth</p> <p>2-Bottle Depth</p> <p>3-Bottle Depth</p>		<p>Install FTC Frame</p>			
Install Wine Pegs On Metal Rails		<p>TIP: Pre-drill holes before installing the Floor-to-Ceiling mount</p>			

3

Mount rails to frame

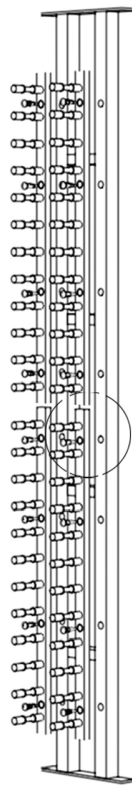
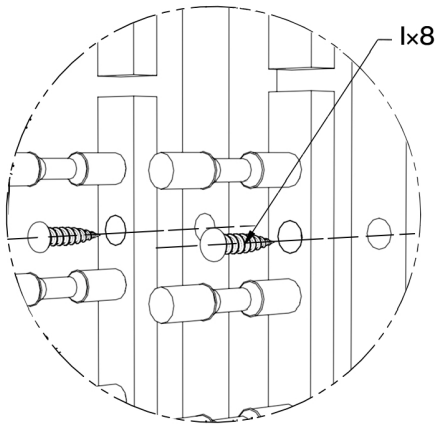

4

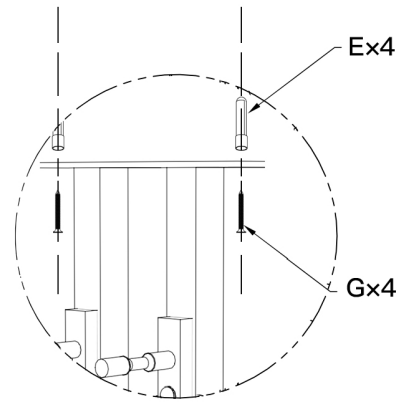

Mount the brackets to the ceiling then the floor

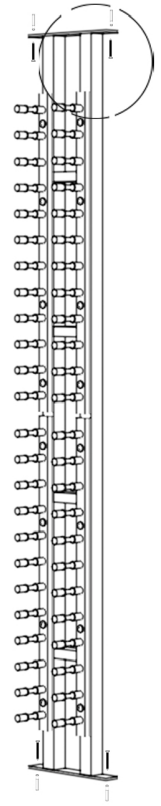

5

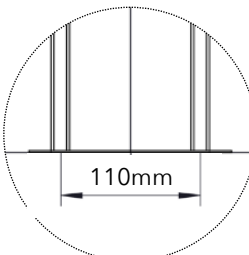
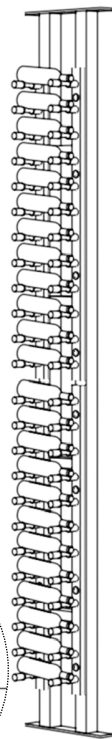

Standard Bordeaux

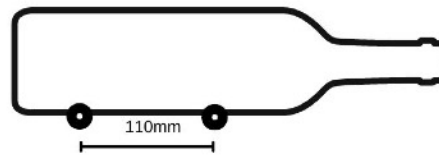

Standard Bordeaux (70mm x 286mm)

Typical Riesling

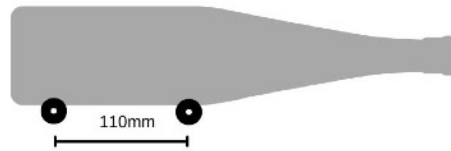

Typical Riesling (70mm x 300mm)

Typical Pinot Noir

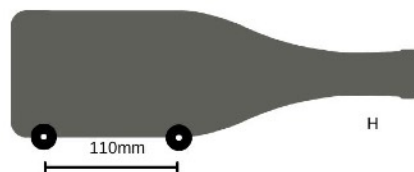

Typical Pinot Noir (80mm x 302mm)

7

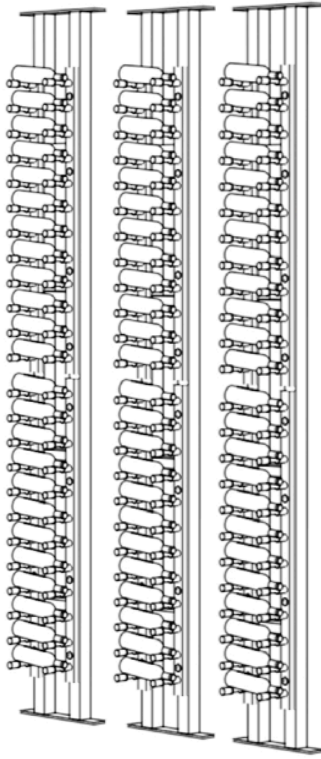

8

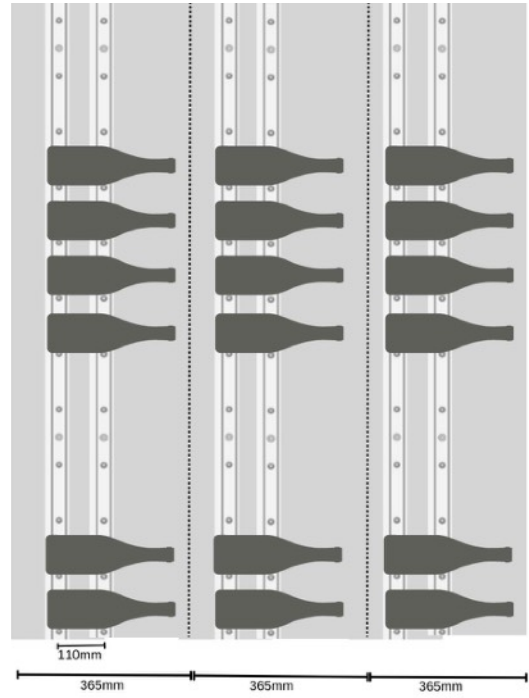

When installing more than one set of wine racks, the minimum horizontal spacing (distance between the centers of two sets) is 365mm.