

2 Personnes requis

**Two People**

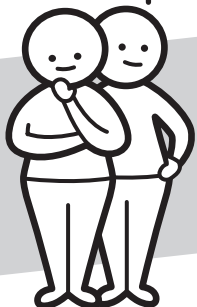

**Required**

5900-1/5900-3/5900-W /5900-2  
5900K-1/5900K-3/5900-W /5900K-2  
Queen Bed/King Bed  
Grand lit/Tres grand lit



ASSEMBLY INSTRUCTIONS/LES INSTRUCTIONS D'ASSEMBLAGE  
HAVE A QUESTION? GIVE US A CALL. 1-800-363-0219  
VOUS AVEZ UNE QUESTION? APPELEZ-NOUS AU 1-800-363-0219

Thank you for purchasing this product from Mazin Furniture. Please take the time to read and follow the instructions below. Check that you have all parts and hardware before assembly. Parts apparently missing are often found in the packing materials. If you do not have all the parts listed, have your dealer contact us and they will be sent to you immediately.

Merci d'avoir acheté ce produit de Mazin Furniture. Veuillez lire et suivre les instructions ci-dessous. Vérifiez avant le montage que vous avez toutes les pièces et fixations. Les pièces qui semblent manquer se trouvent souvent dans les matériaux d'emballage. Si vous n'avez pas toutes les pièces de la liste, demandez à votre détaillant et nous vous les enverrons immédiatement.

### Cleaning Instructions / Instructions de nettoyage

Protect from direct sunlight, direct heat and weather. All covers will fade over time. Do not remove cover for cleaning. Vacuum regularly using low suction. Professional cleaning recommended. Blot food and liquid spills immediately with a dry, white, clean cloth. Do not rub. If required for further cleaning, use a mild non-coloured, pure soap solution made from soap flakes mixed with warm water. Dry in shade away from direct heat and sunlight. Allow to dry thoroughly.

Protéger de la lumière directe du soleil, de la chaleur directe. Toutes les couvertures s'estomperont avec le temps. Ne retirez pas le couvercle pour le nettoyer. Passez l'aspirateur régulièrement en utilisant une faible aspiration. Nettoyage professionnel recommandé. éponger immédiatement les aliments et les liquides renversés avec un chiffon sec, blanc et propre. Ne pas frotter. Si nécessaire utilisez une solution savonneuse douce et non colorée à base de flocons de savon mélangés à de l'eau tiède. Sécher à l'abri de la chaleur directe et du soleil. Laisser sécher complètement.

# Parts list/Liste des pieces

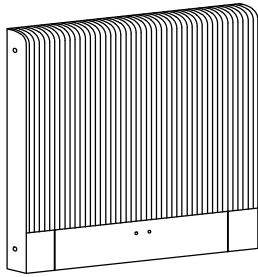

Headboard (P1)/Tête de lit (P1)



2 x Footboard Legs (P6)  
2 x jambes de pied (P6)

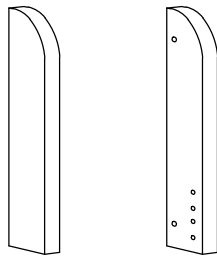

2 x Wings (P2)/2 x Aile (P2)

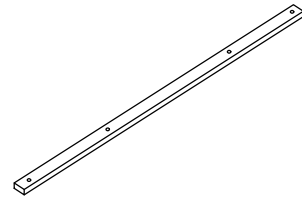

Centre Rail (P7)/longeron central (P7)

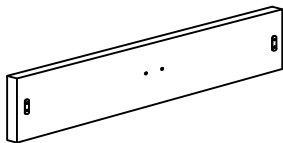

Footboard (P3)/Pied de lit (P3)



2 x Brackets (P8)  
2 x équerre (P8)

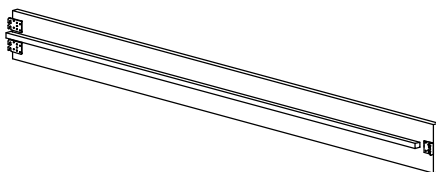

Right Side Rail (P4)  
Rail latéral droit (P4)

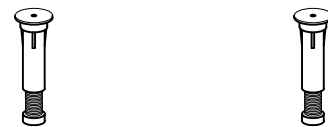

2 x Plastic Support Legs (P9)  
2 x jambes de Support en plastique (P9)

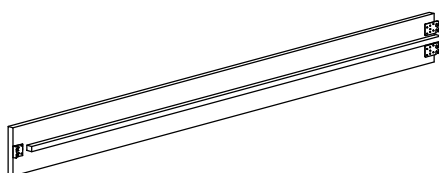

Left Side Rail (P5)  
Rail latéral gauche (P5)

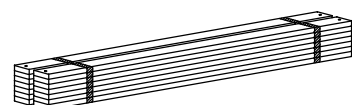

Slats (P10)/Lattes (P10)

# Hardware pack/Liste De Quincaillerie



4 x Big Head Bolts  
4 x gros boulons de tête  
(H1)



2 x Small Bolts  
2 x petits boulons  
(H2)



14 x Medium Bolts  
14 x boulons moyens  
(H3)

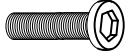

6 x Long Bolts  
6 x boulons longs  
(H4)

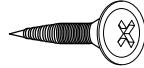

4 x Small Screws  
4 x petites vis  
(H5)



42 x Large Screws  
42 x grandes vis  
(H6)



2 x Small Washers  
2 x petites rondelles  
(H7)



12 x Large Washers  
12 x Grandes rondelles  
(H8)



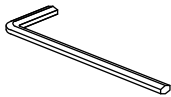

Small Allen Key  
Petite clé Allen  
(H9)

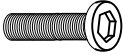

Large Allen Key  
Grande clé Allen  
(H10)

# Step 1/étape 1

You will need / Vous aurez besoin		
		
4 x Long Bolts 4 x boulons longs (H4)	4 x Large Washers 4 x Grandes rondelles (H8)	Large Allen Key Petite clé Allen (H10)

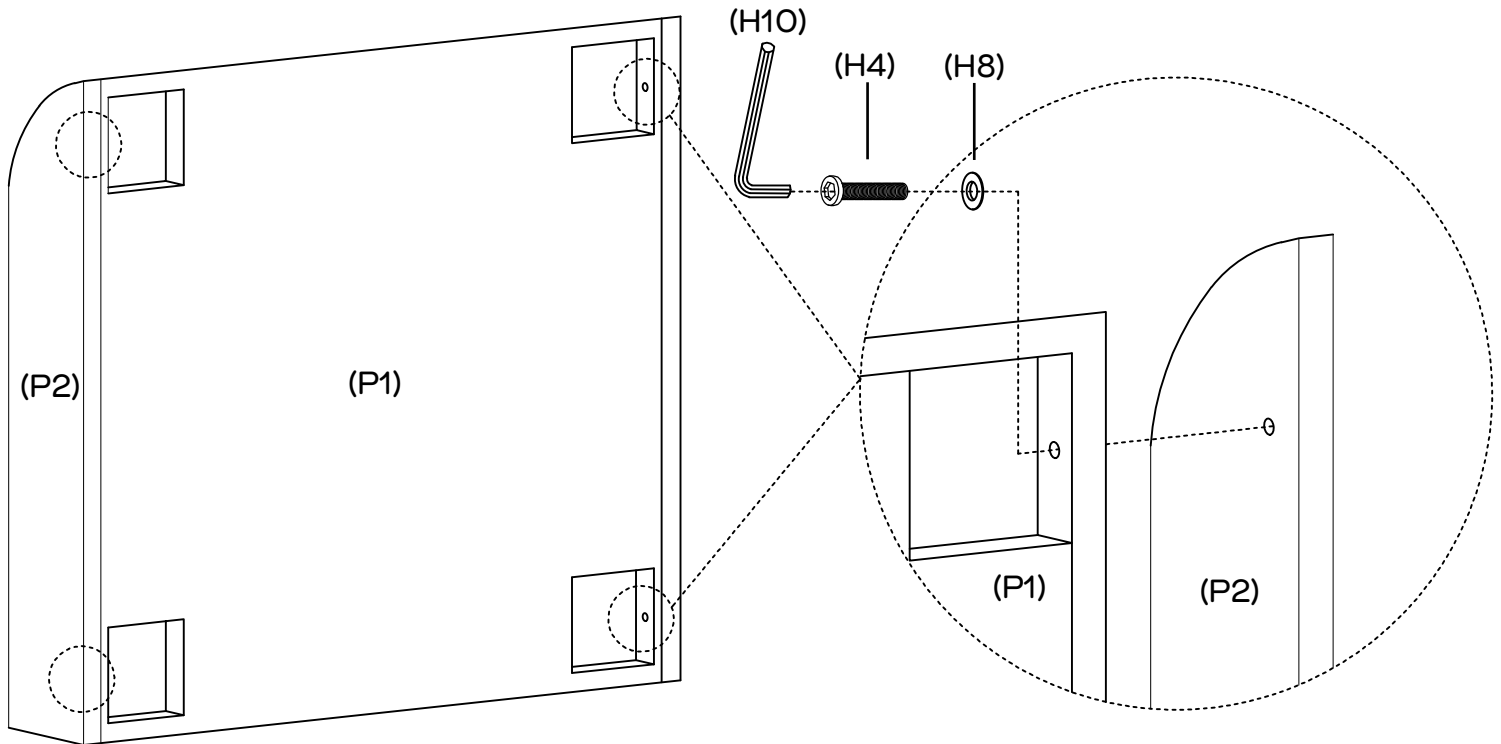





Attach 2 x wings (P2) to the headboard (P1) with 4 x long bolts (H4) and 4 x washers (H8), tightening using the large allen key (H10).

Attacher 2 x ailes (P2) à la tête de lit (P1) avec 4 x boulons longs (H4) et 4 x rondelles (H8), serrage à l'aide de la grande clé d'Allen (H10).

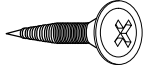
## Step 2/étape 2

You will need / Vous aurez besoin

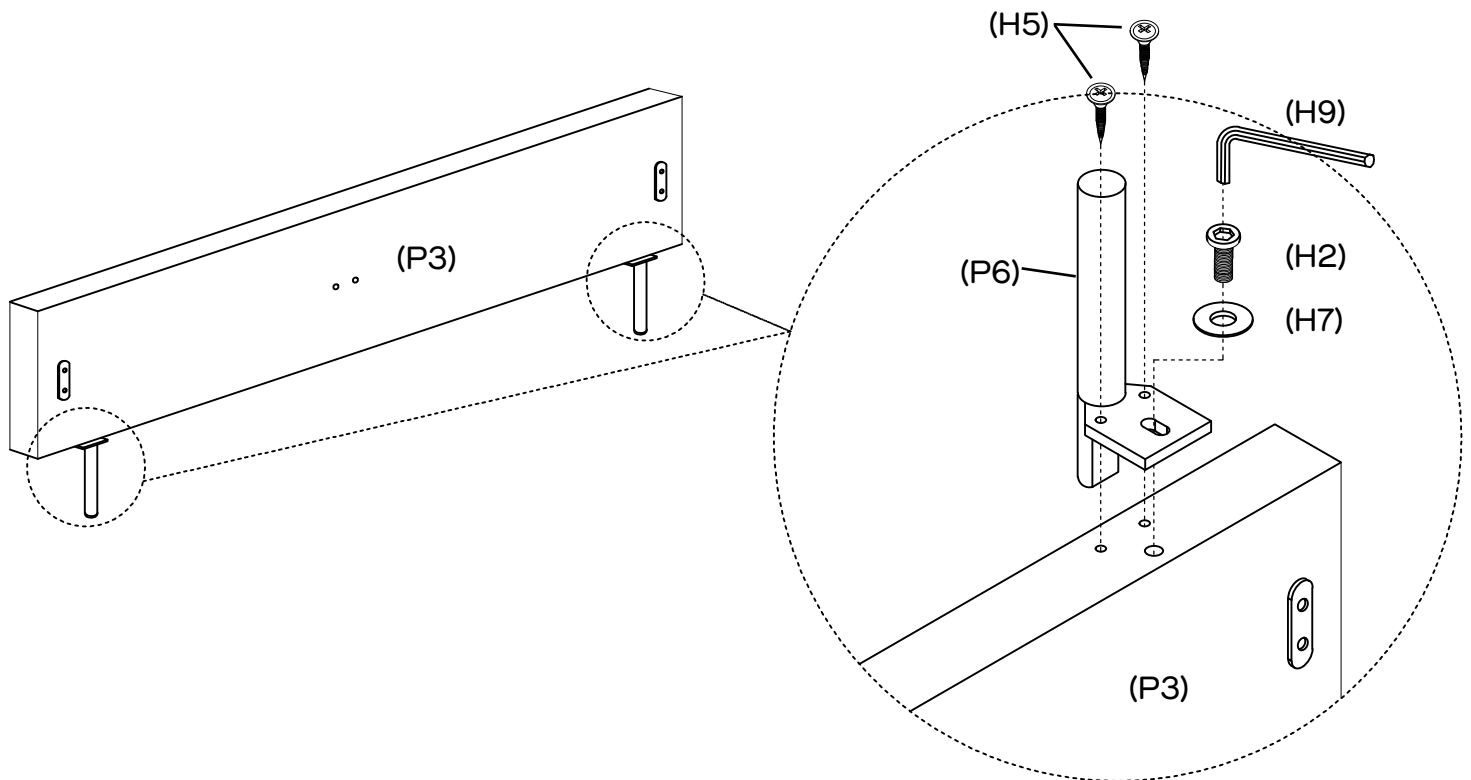

				
2 x Small Bolts 2 x petits boulons (H2)	4 x Small Screws 4 x petites vis (H5)	2 x Small Washers 2 x petites rondelles (H7)	Small Allen Key Petite clé Allen (H9)	Phillips Head Screwdriver (not provided) tournevis Phillips(non fourni)



Attach 2 x footboard legs (P6) to the bottom of the footboard (P3) using 4 x small washers (H7), 4 x small bolts (H2), tightening using small allen key (H9).  
Further secure the legs (P6) using 2 x small screws (H5), tightening with a phillips head screwdriver (not provided).

Attacher 2 x jambes de pied (P6) au fond du pied (P3) en utilisant 4 x petits rondelles (H7), 4 x petits boulons (H2), serrage à l'aide de la petite clé d'Allen (H9).  
Sécurisez davantage les jambes (P6) en utilisant 2 x petites vis (H5), serrant avec un tournevis Phillips (non fourni).

## Step 3/étape 3

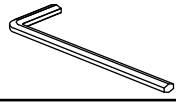
You will need / Vous aurez besoin		
		
4 x Big Head Bolts 4 x gros boulons de tête (H1)	8 x Medium Bolts 8 x boulons moyens (H3)	Large Allen Key Petite clé Allen (H10)

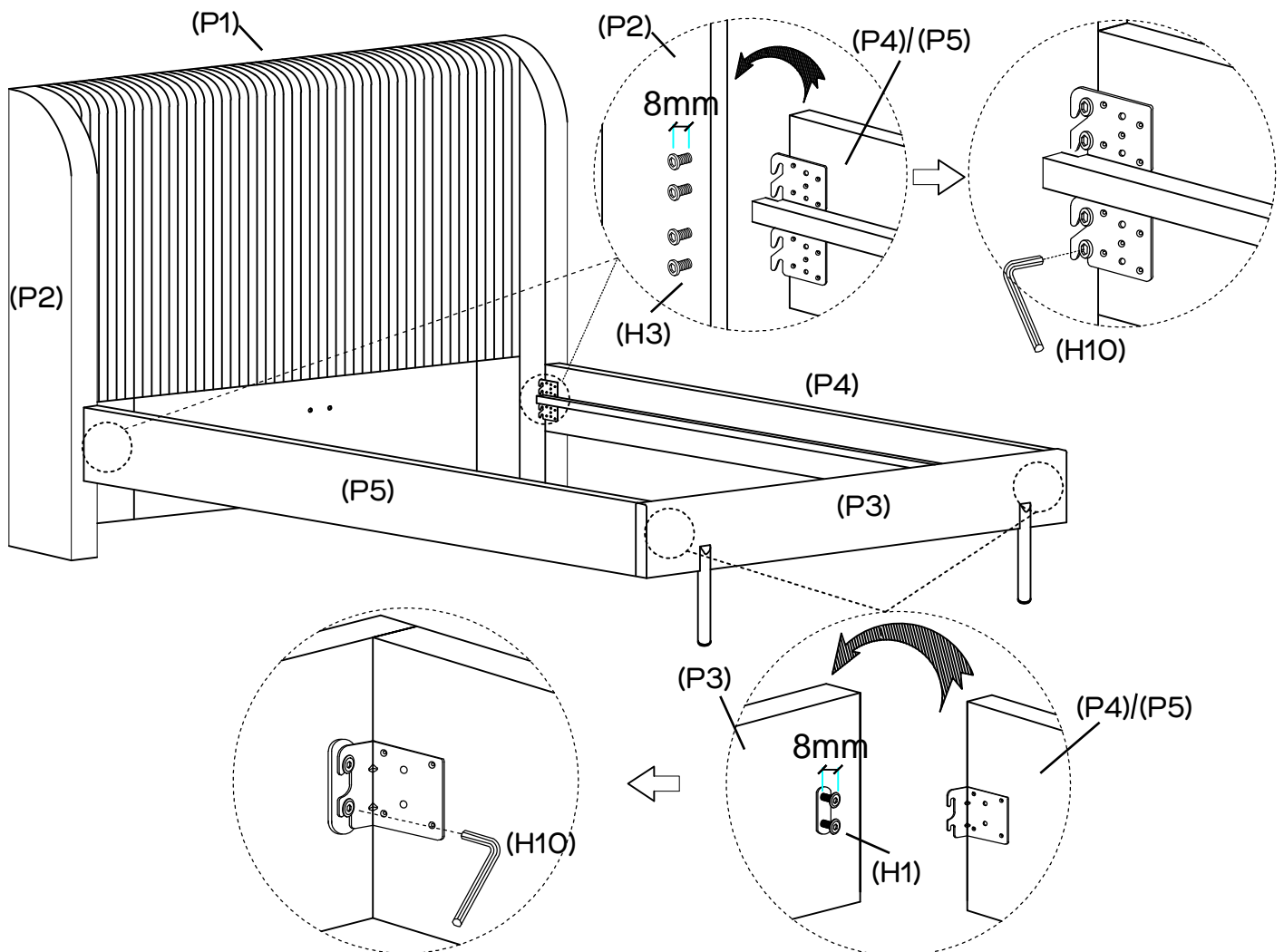

Install 8 x medium bolts (H3) to the wings (P2) and install 4 x big head bolts (H1) to the footboard (P3), do not tighten the bolts and keep them 8mm loose.

Then attach 2 x side rails (P4) / (P5) to headboard (P1) and footboard (P3) by slotting the bracket on the side rails (P4) / (P5) over the bolt as shown.



Please do not tighten bolts until step 6.

Installer 8 x boulons moyens (H3) sur les ailes (P2) et 4 x boulons gros (H1) sur le plancher (P3), ne pas serrer les boulons et les garder libres de 8mm.

Ensuite, connectez 2 x longitudinaux (P4) / (P5) à la tête de lit (P1) et à la pédale (P3) en entaillant le longitudinal (P4) / (P5) au - dessus des boulons, comme indiqué.

Ne serrez pas les boulons avant l'étape 6.

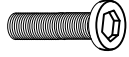
## Step 4/étape 4

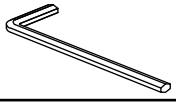
You will need / Vous aurez besoin			
			
2 x Medium Bolts 2 x boulons moyens (H3)	2 x Long Bolts 2 x boulons longs (H4)	4 x Large Washers 4 x Grandes rondelles (H8)	Large Allen Key Petite clé Allen (H10)

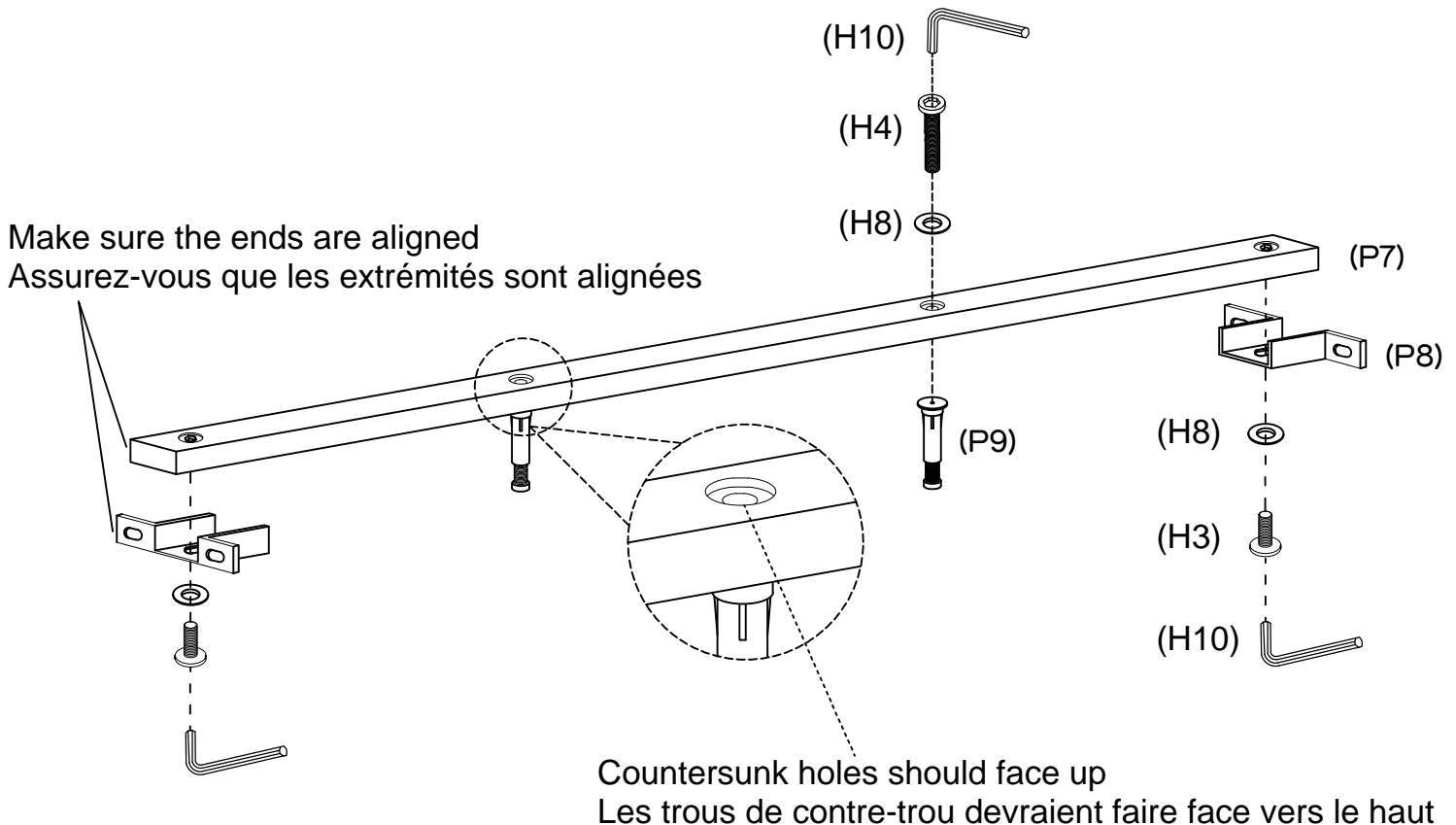

Attach the 2 x support legs (P9) to the centre rail (P7) using 2 x long bolts (H4) and 2 x large washers (H8), tightening with large allen key (H10).



Attach 2 x brackets (P8) to the ends of centre rail (P7) using 2 x medium bolts (H3), 2 x large washers (H8), tightening with large allen key (H10).

Fixer les 2 x jambes de soutènement (P9) au longeron central (P7) en utilisant 2 x boulons longs (H4) et 2 x grandes rondelles (H8), serrées avec une grande clé Allen (H10).

Fixer 2 x crochets (P8) aux extrémités du longeron central (P7) à l'aide de 2 x boulons moyens (H3), 2 x grandes rondelles (H8), serrées avec une grande clé Allen (H10).

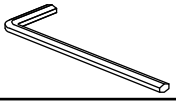

## Step 5/étape 5

You will need / Vous aurez besoin		
		
4 x Medium Bolts 4 x boulons moyens (H3)	4 x Large Washers 4 x Grandes rondelles (H8)	Large Allen Key Petite clé Allen (H10)

**You must use.**  
**Vous devez utiliser.**

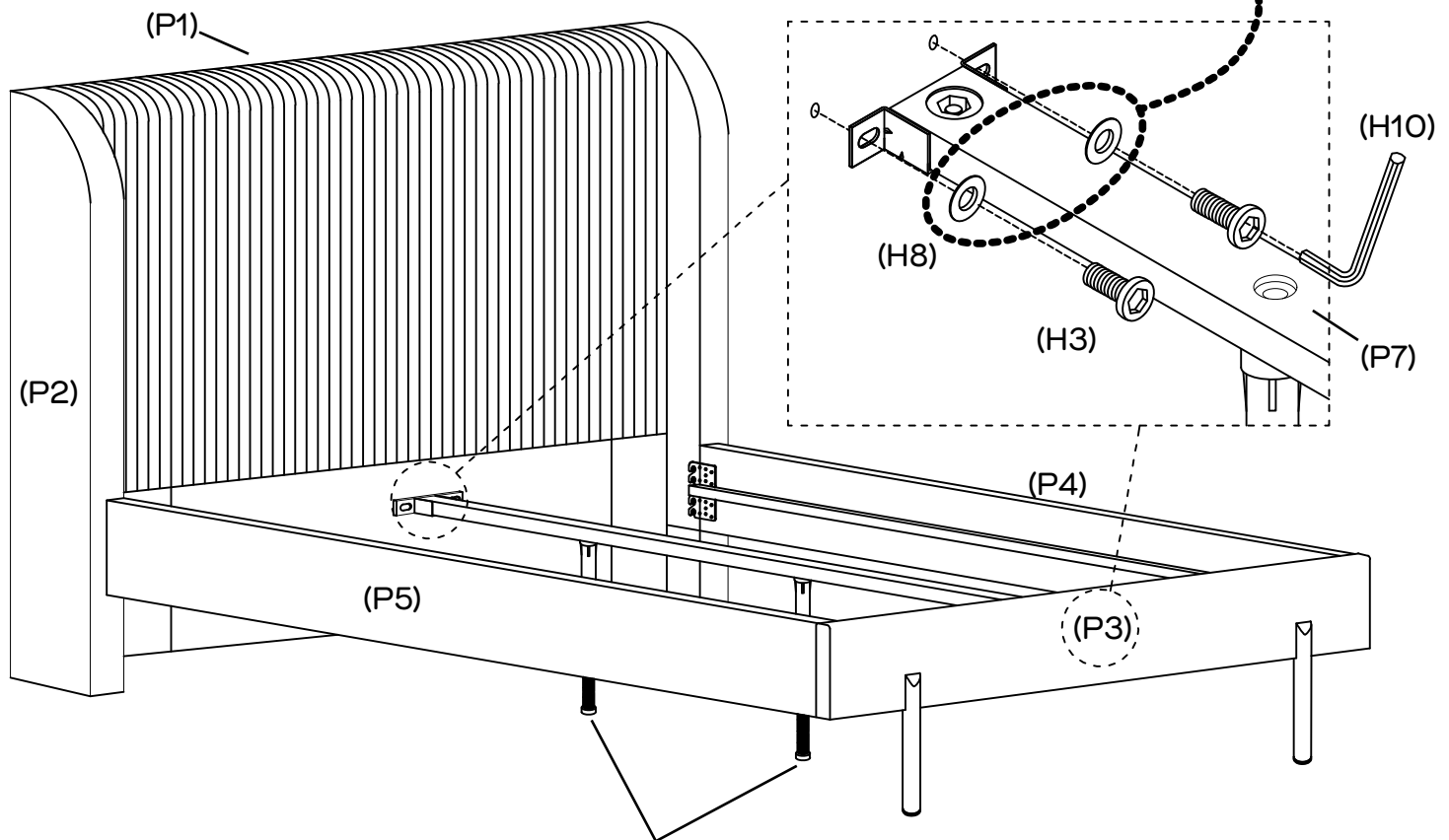

Adjust to be 10mm gap from floor to the bottom of support legs.

Réglez à 10mm d'intervalle entre le sol et le bas des jambes de soutènement.

Slot the centre rail (P7) into the headboard (P1) and footboard (P3).

Rotate 4 x medium bolts (H3) and 4 x large washers (H8) by using large Allen Key (H10) to the headboard (P1) and footboard (P3).



Please do not tighten bolts until step6.

Insérer le rail - guide central (P7) dans la tête de lit (P1) et la pédale (P3).

à l'aide d'une grande Clé Allen (H10), tourner quatre boulons moyens (H3) et quatre grandes rondelles (H8) sur la tête de lit (P1) et la pédale (P3).

Pas besoin de serrer les boulons jusqu'à l'étape 6.

## Step 6/étape 6

You will need / Vous aurez besoin	
	
42 x Large Screws 42 x grandes vis (H6)	Phillips Head Screwdriver (not provided) tournevis Phillips(non fourni)

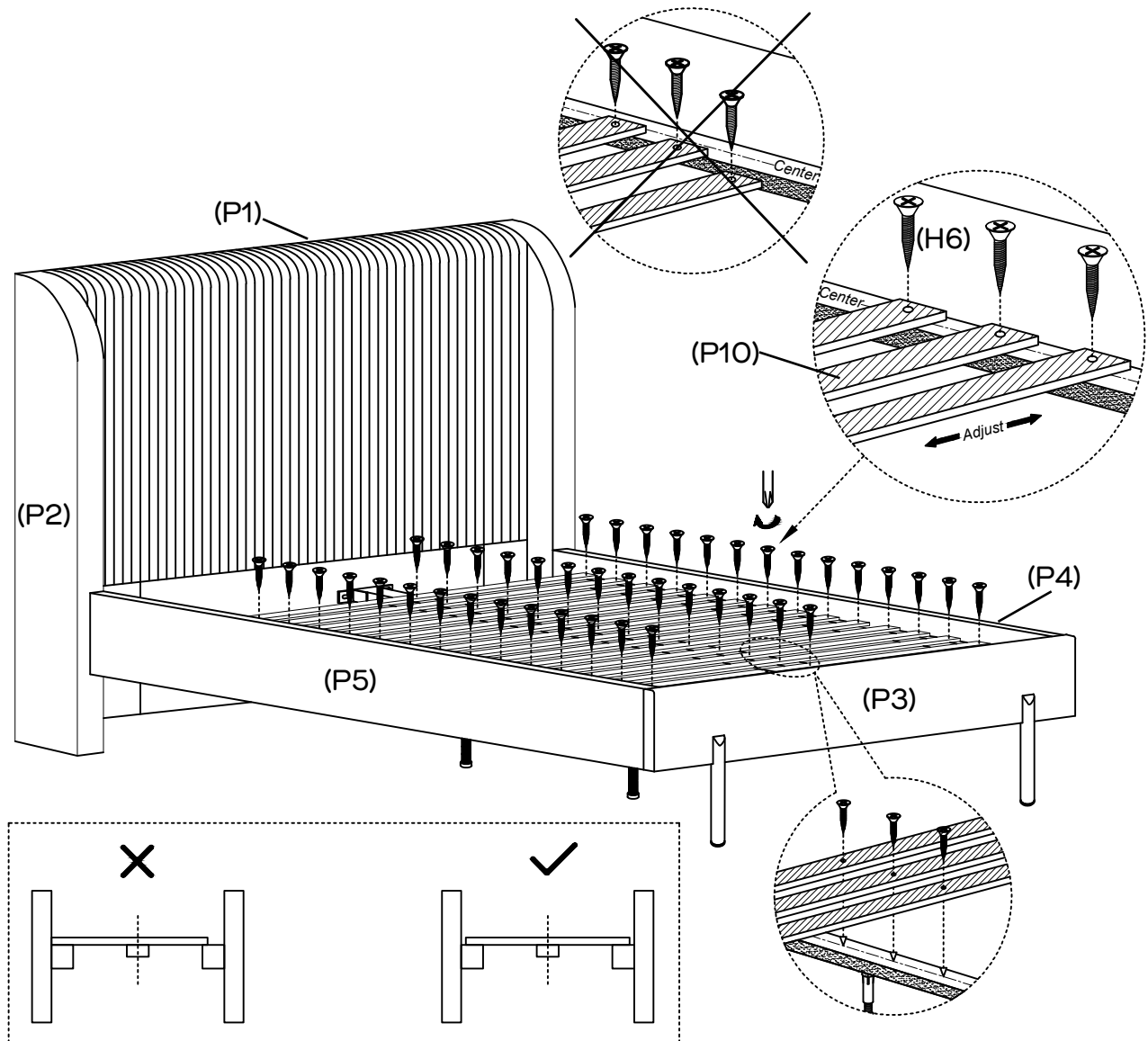

Ensure the inner space is square and even as shown above.

Assurez - vous que l'espace intérieur est carré et uniforme comme indiqué ci - dessus.

Now tighten all the bolts on the headboard(P1),footboard(P3), and side rails (P4/P5). Attach the Slats (P10) to the assembled frame using 42 x large Screws (H6) and the Phillips head Screwdriver as shown.

Ensure the Slats (P10) are centred before screwing them to the bed frame.

Maintenant, serrez tous les boulons sur le hayon avant (P1), le pied (P3) et les rails latéraux (P4/P5).

Fixer les lattes (P10) au cadre assemblé en utilisant des vis de 42 x de grande taille (H6) et le tournevis Phillips comme indiqué.

Assurez-vous que les lattes (P10) sont centrées avant de les visser sur le cadre du lit.

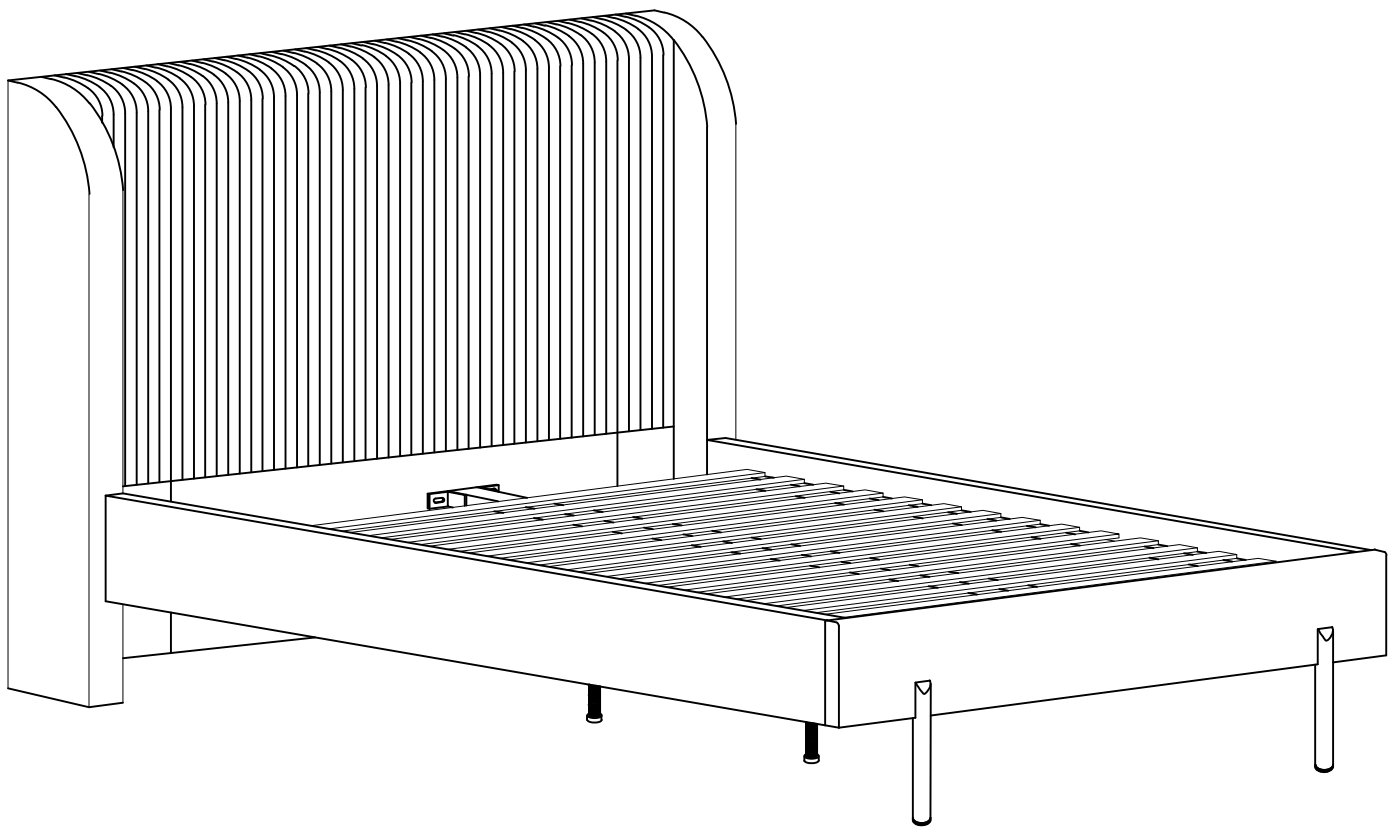

## Job complete!/Travail terminé!

In the interest of our environment please dispose  
of all packaging thoughtfully.

Dans l'intérêt de notre environnement, veuillez disposer  
De tous les emballages soigneusement.