

FEATURES

- ▶ .45", 3½ digit display
- ▶ User-selectable decimal points
- ▶ User-selectable engineering units
- ▶ Non-backlit LCD or choice of AMBER, GREEN, RED or POS GREEN backlit LCD
- ▶ Wide ZERO (Offset) & SPAN (Gain) adjustment
- ▶ Snap-in panel mounting
- ▶ Gasket and clamp provided for NEMA 4, NEMA 12 & IP66 applications

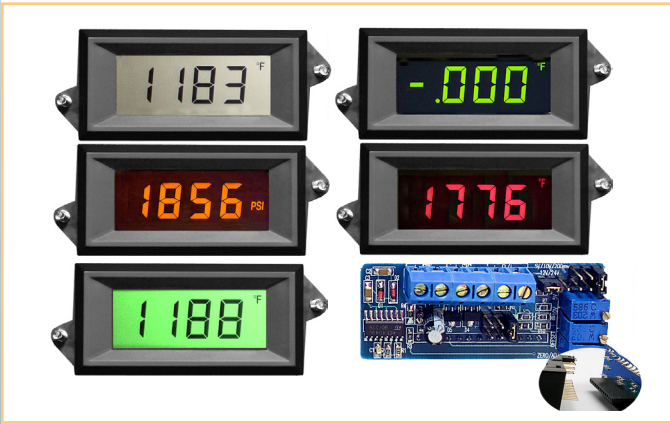

SPECIFICATIONS

DISPLAY

Digits: 3 ½ digits (±1999 counts)
 Type: .45" (11.4 mm) 7 segment high contrast LCD
 Polarity: automatic, "-" displayed
 Annunciators: °F, °C, PSI, %, user-selectable
 Decimal Points: 3 position, user-selectable
 Overrange: three lower order digits blank for inputs >1999 & < -1999

INPUTS

Voltage Ranges: 5 V, 10 V adjustable, 200mV fixed
 Configuration: single ended
 Impedance: 390KΩ

PERFORMANCE

Accuracy: ±(0.05% of full scale + 1 count)
 Conversion Rate: 3 per second
 Normal Mode Rejection: >30 dB @ 60 Hz
 Warmup: 10 minutes typical
 Temperature Coeff.: ± 100 ppm per °C typical
 Adjustments: 25 turn potentiometers
 Offset Range: -1999 to +1999
 Gain Range: 1 to 1999 (custom ranges available)

ENVIRONMENT

Operating Range: 10 to 50 °C
 Storage Range: -10 to 75 °C

POWER SUPPLY

12/24 DC

MOUNTING

snap-in panel mount or clamp and gasket (included)

CONNECTION

screw terminals

ORDERING INFO

PART NUMBER	BACKLIGHT COLOR	METER INPUT	METER POWER
VPI-3-XEC	NO BACKLIGHT	Voltage	12/24VDC
VPI-3A-XEC	AMBER	Voltage	12/24VDC
VPI-3G-XEC	GREEN	Voltage	12/24VDC
VPI-3R-XEC	RED	Voltage	12/24VDC
VPI-3GP-XEC	POS GREEN	Voltage	12/24VDC

ACCESSORIES

PW2-12	Regulated 120V AC to 12V DC Power Supply
PW2-24	Regulated 120V AC to 24V DC Power Supply
PW1.0	.24V AC to adjustable DC output
PW1.5	.24V AC to adjustable DC output
CVC	Calibrator



Specifications Installation and Operating Instructions
LCD Digital Panel Meters
 Adjustable Voltage Powered 3½ Digit



DIMENSIONS

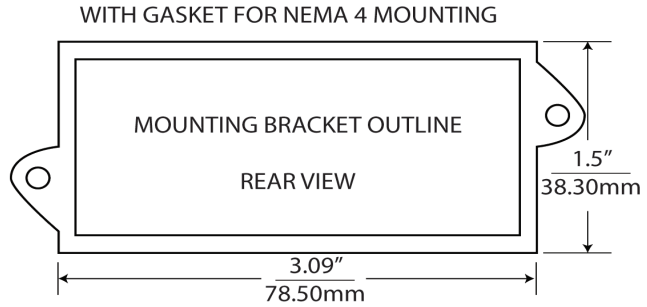
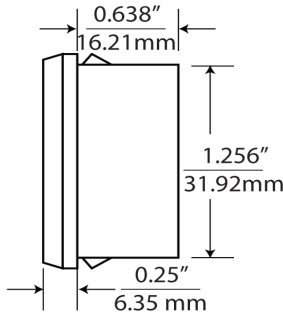
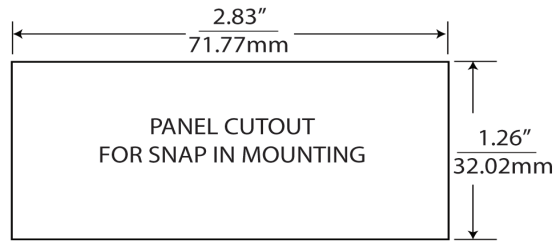
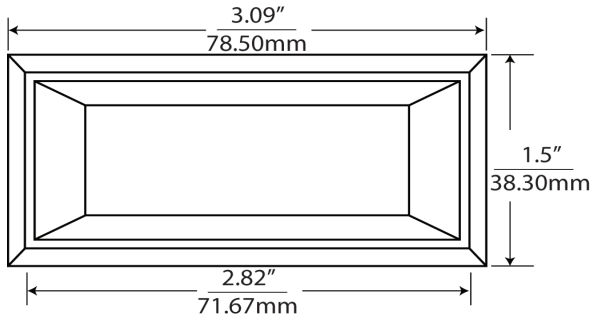

inches
mm

NOTES:

1. Panel thickness is: 0.032"/0.81mm to 0.25"/6.35mm
2. Gasket supplied is: 0.09"/2.25mm thick

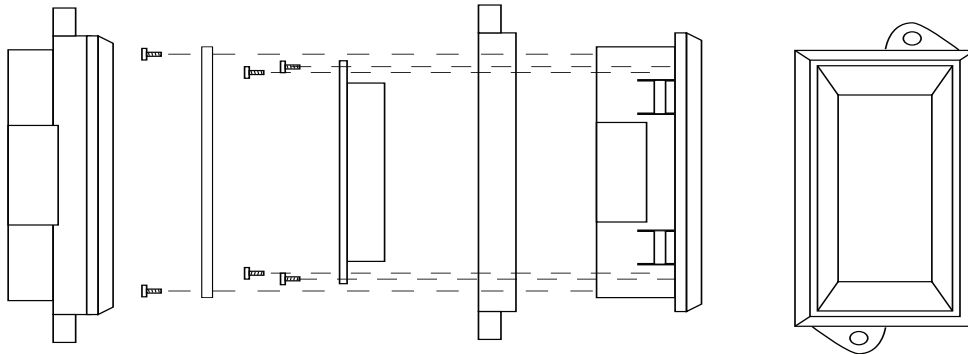

WIRING

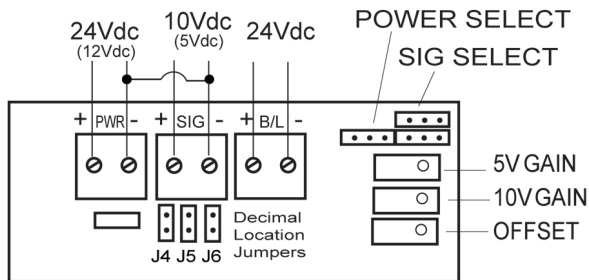

Decimal Point Selection

1. Locate jumpers J4 through J6 in the middle of the circuit board unit.
2. Jumper the appropriate decimal location as follows:
 J4 - 000.0
 J5 - 00.00
 J6 - 0.000
 None - 0000

