



**RIFFE**



***Our mission is to provide premium spearfishing and snorkeling equipment for everyone who enjoys the ocean, inspiring a healthy and exciting lifestyle.***

***Our vision is to inspire individuals globally to enjoy thrilling aquatic pursuits and harvest their food responsibly***

JAY RIFFE began spearfishing off the Southern California Coast with a hand spear at age 10. At that time his goal was to obtain a fresh catch for the dinner table. At fifteen he entered select spearfishing competitions, and by age twenty-two became the Pacific Coast Champion. Jay then placed in the Nationals, landing a spot on the World Spearfishing Team, all the while honoring his intention of making sure to eat what he caught. Later, he set three World Records all with his own handcrafted wooden spearguns.

***Over 40 years of wood speargun building experience.***

Early on, Jay recognized a need for spearguns that were silent, powerful, accurate, and highly maneuverable. Harnessing his professional machine tool engineering with his passion for spearfishing he created ergonomically designed, handcrafted teak wood spearguns of unsurpassed quality and optimum performance.

Fast forward to 2024 and RIFFE International, Inc. remains family owned and operated and continues to build quality, durable, accurate wood spearguns for the Silent Hunter. Currently, RIFFE is proud to offer, not only the most reliable spearguns, but a variety of diving, spearfishing and snorkeling gear. Our goal is to produce high quality products for everyone who enjoys the ocean and share our philosophy to be mindful and take only what is needed for consumption.



*Fish for the Future*

---

*“All divers should protect the waters they swim and hunt in, ensuring future divers the experience and excitement of freediving that I’ve had for over sixty-nine years.*”

*I strive to produce high quality spearfishing and diving equipment capable of handling any condition.*

*Selective Divers set their sights on those few prize fish for consumption. Be Selective, Fish for the Future.”*

---

Jay Riffe  
Founder / Innovator / Spearfisherman  
RIFFE International, Inc.

---

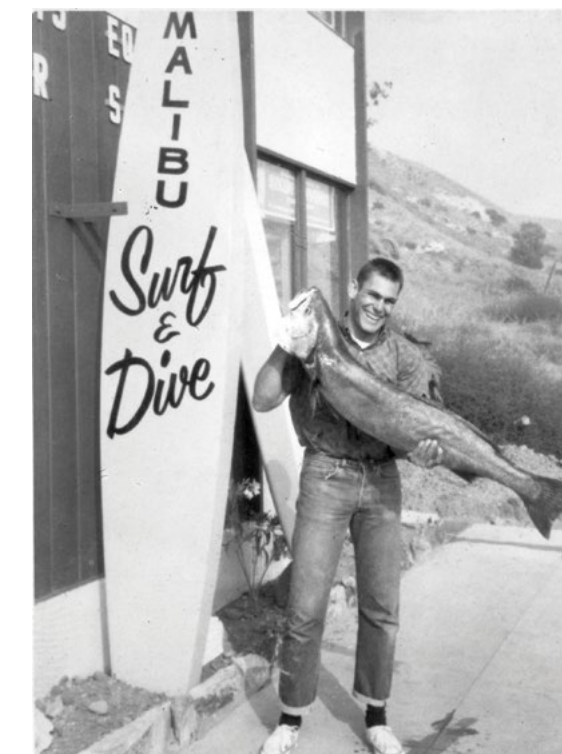



*SPEARGUNS 6*

*SPEARSHAFTS, TIPS, & SLIDE RINGS 14*

*POLE SPEARS 20*

*REELS & LINE 24*

*SPEARGUN KITS 25*

*SPEARGUN PARTS & ACCESSORIES 26*

*POWER BANDS, SHOOTING LINE & CRIMPS 28*

*KNIVES 30*

*FLOAT SYSTEMS & ACCESSORIES 32*

*MASKS & SNORKELS 36*

*ADVENTURE COLLECTION 40*

*FINS 46*

*WEIGHT BELTS & GLOVES 49*

*WETSUITS & RASH GUARDS 50*

*GEAR BAGS & ACCESSORIES 56*

*APPAREL 57*



# THE MARAUDER

**THE MARAUDER** A sleek, streamlined 5 laminate mahogany wood silhouette comprised of 3 sizes, 47, 55, and 63. The Marauder Series covers an array of spearfishing environments from reef and inshore to blue water hunting. The closed band slot design, requiring Tie In Power Bands, combined with the Euro Style M-Tab Spear Shaft delivers extra band stretch for maximum power. Whether hunting snapper along reef or wahoo and tuna in open water, The Marauder has got you covered.  
**47, 55, 63, 63S**



## FEATURES:

- 5 laminate mahogany wood stock
- RIFFE's stainless steel 2-piece trigger mechanism assembly. Accepts shafts: 9/32"(7.1mm), 19/64" (7.5mm) and 5/16"(8mm)
- Side rotating Spring Loaded Safety
- 47, 55 & 63 come standard with NEW 19/64" Hawaiian Double Flopper Euro style M-TAB spear shaft (3 large tabs)
- 63S rigged with 5/16" (8mm) x 62" (157cm) 6mm Threaded Euro style M-TAB spear shaft (3 large tabs) with Mini Slip Tip (Needle point)
- 47, 55 & 63 come standard with Tie In (3) 9/16" (14mm) black Gorilla Rubber power bands
- 63S standard with Tie In (3) 5/8" (16mm) black Gorilla Rubber power bands
- Rigged with 300 lb. Nylon monofilament shooting line for faster shooting and abrasion resistance.
- 5" Bungie Shock Chord with 500 lb. test Pigtail Swivel (400lb. Snap Swivel)

- Heavy-duty reinforced glass filled Nylon handle with over molded cushion grip
- RIFFE's signature Mag-Track
- Automatic side mounted Line Release
- Built in stainless steel threaded reel inserts, designed to fit RIFFE's Horizontal Reel – Flat mount
- Contoured black urethane butt end assembly for comfortable loading
- Accepts most suitable RIFFE accessories & parts

All models may be rigged to customer's preference when ordering. See pg.18 for all models' specs



Side Rotating Spring Loaded Safety



Closed Band Slot requires Tie In Bands

## RAIDER MID-HANDLE

**THE RAIDER MID-HANDLE SERIES** The New RAIDER pays tribute to the history of blue water hunting speargun design. Using its forerunner the RIFFE Blue Water Elite, as an origin point, our Team led the development challenge with an emphasis on increasing accuracy, shooting range, and maneuverability to produce the next mid-handle

generation. A refined evolutionary design embodies power and adaptability with its commanding mass, integrated full body length wings, new ABS (Adjustable Ballast System), high impact and distinct shape. The **RAIDER is the true pinnacle of craftsmanship, efficacy and what BIG spearfishing dreams are made of.**



### FEATURES:

- Heavy-duty 5 laminate Mahogany wood stock
- Integrated Full Body Wings
- ABS (Adjustable Ballast System) enables compensating adjustments for preferred rigging and negative buoyancy when loaded
- RIFFE's Stainless Steel 2-Piece trigger mechanism assembly
- Toggle Safety etched with "S" for Safe & "F" for Fire
- 55 & 61 come standard with 5/16" 24 thrd Threaded American Notch spear shaft (3 large tabs) with Slip Tip (Needle Point)
- 67 & 70 come standard with 11/32" Threaded American Notch Spear Shaft (4 large tabs + Rest Tab) with Tri-Cut Slip Tip & Breakaway Setup
- Tie In 5/8" (16mm) Black Gorilla Rubber Power Bands [55 & 61 (3), 67 (4) & 70 (5)]
- 55 & 61 Rigged with 400 lb. Nylon Monofilament Shooting Line for faster shooting and abrasion resistance
- 67 & 70 Rigged with 500 lb. Stainless Steel Coated Cable
- 5" Bungee Shock Chord with 500 lb. test Pigtail Ball Bearing Swivel

- Heavy-duty reinforced glass filled Nylon handle with over molded cushion grip
- Enclosed Track
- Side mounted Line Release
- 55 & 61 come standard with built in stainless steel Threaded Inserts, designed to fit RIFFE's Horizontal Reel - Flat Mount
- Contoured signature red urethane butt end or comfortable loading

- 55" - 5/16" x 53" (140cm) 24 thrd Threaded shaft w/ Slip Tip
- 61" - 5/16" x 59" (152cm) 24 thrd Threaded shaft w/ Slip Tip
- 67" - 11/32" x 65" (165cm) 24 thrd Threaded shaft w/Rest Tab w/ Tri-Cut Slip Tip / Breakaway setup
- 70" - 11/32" x 68" (172cm) 24 thrd Threaded shaft w/Rest Tab w/ Tri-Cut Slip Tip / Breakaway setup |

Accepts most suitable RIFFE parts and accessories.  
All models may be rigged to customer's preference when ordering.  
See pg.18 for all models' specs.



**NOTE: More powerful models must be fired with two hands to prevent injury from excess recoil**

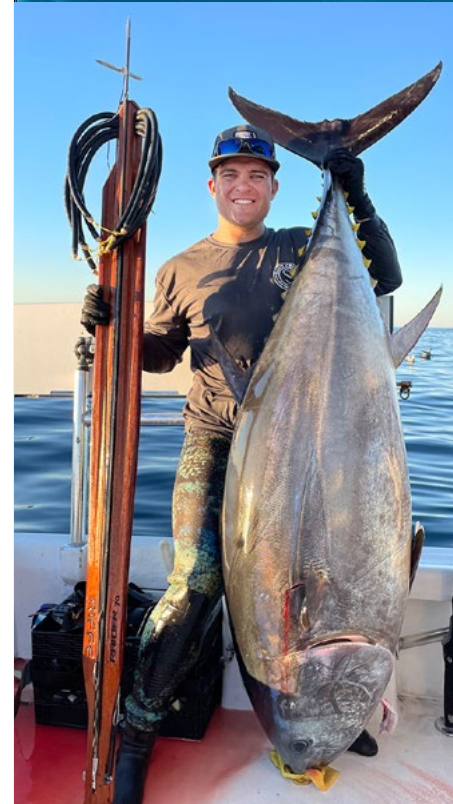

## COMPETITOR MAHOGANY

**COMPETITOR MAHOGANY SERIES** are made from Mahogany, a dense straight grain hardwood which allows for a solid stock construction with no lamination required. Competitively priced and suitable for entry-level and advanced divers alike who plan to hunt around kelp patties, reefs, holes, and along the seafloor.

Models #3 and #3X have blue water hunting capabilities with proper upgrades. A Rest Tab may be added for ease of loading and for lower power shooting around rocks.

#00, #0, #1, #2, #2X, #3, #3X



### FEATURES:

- Solid Mahogany wood stock
- RIFFE Stainless Steel 2-Piece trigger mechanism assembly, accepts all diameter shafts: 1/4" (6.5mm), 9/32" (7.1mm), 5/16" (8mm), 11/32" (8.7mm), 3/8" (9.5mm)
- Side rotating spring loaded safety
- 9/16" (14mm) black coated amber RIFFE Gorilla Rubber power bands with 1000 lb. Spectra Wishbone line
- 5" Bungee Shock Chord with 500 lb. test Pigtail Swivel
- Rigged with 300 lb. abrasion resistant Nylon monofilament shooting line for faster shots
- Automatic side mounted line release
- Reinforced muzzle
- Heavy-duty ABS Plastic Handle
- Contoured red urethane butt end for comfortable loading

• **Hawaiian Flopper Setup:** 9/32" (7.1mm) Hawaiian or Tahitian Flopper Shaft, 1 wrap of line and 2 power bands for close range shooting.

### Optional Setups:

- Rest tab for ease of loading and lower shooting power around rocks
- 5/8" (16mm) bands for more hitting power on longer shafts
- 400 lb. 5" Bungee Snap Swivel
- 400 lb. abrasion resistant Nylon monofilament shooting line for heavier shafts
- Bolted reinforced muzzle

Accepts all suitable RIFFE parts and accessories. See pg.18 for all models' specs.



**COMPETITOR MAHOGANY X** models feature a 3.25" (8.25cm) rear stock extension for ease of hip loading and aids in faster swing (Shown above).

## EURO - TRAVEL

**EURO TRAVEL SERIES** Ideal for anyone who would like the ease of traveling with a speargun. Stock breaks down into two sections. Designed for all level of divers. Riffe's Mag-Track feature offers a faster shaft engagement, ideal for free shafting. Euro Series gun barrels are

manufactured in a rectangular shape with radius corners for maximum beam strength. All models come standard with threaded stainless steel reel inserts for mounting a reel. Models E110 and larger have blue water capabilities. **EUROT-90, EUROT-100, EUROT-110, EUROT-120**



### FEATURES:

- Low-Profile, 3 vertical laminate teak stock
- RIFFE's Stainless 2-Piece Steel Trigger Mechanism with added silencer
- RIFFE's signature Mag-Track
- Side rotating spring loaded safety
- Comes standard with 19/64" (7.5mm) break down Hawaiian flopper Euro Travel Shaft
- (2) 5/8" (16mm) black coated amber RIFFE Gorilla Rubber power bands with 1000 lb. Spectra wishbone line (accepts (3) 9/16" (14mm), (2) 5/8" (16mm) or (2) 3/4" (19mm) power bands)
- Rigged with 600 lb. Spectra shooting line
- 5" Bungee Shock Chord with 500 lb. test Pigtail Swivel
- Automatic side mounted line release
- Reinforced bolted muzzle
- 2 hardened non corrosive stainless steel 8mm rods secure sections

- Heavy-duty reinforced glass filled Nylon handle with over molded cushion grip
- Rear loading pad with full vision when aiming down the shaft
- Built in threaded reel inserts, designed to fit the RIFFE Horizontal Reel - Flat mount

### Optional Setups:

- Spearheads sold separately
- 400 lb. 5" Bungee Snap Swivel
- RIFFE Horizontal Reel

All models may be rigged to customer's preference when ordering. See pg.18 for all models' specs



**NOTE: \*Travel Break down shaft ships in (2) pieces. A semi-permanent threadlocker (included with a Euro Travel Speargun purchase) must be applied before joining the sections together. Make sure to tighten with a wrench to ensure a secure and strong connection.**

## EURO

**EURO SERIES** One of our Best Seller series worldwide. RIFFE pioneered the Euro style speargun design featuring a lower profile which is seen across the market today. Made from 3 vertical teak laminates and shaped into a rectangular outline. Radius corners offer maximum beam

strength. Muzzle is reinforced with a stainless steel plate. All models come standard with threaded stainless steel reel inserts for mounting a reel.  
**E-55, E-75, E-90, E-90X, E-100, E-100X, E-110, E-110X, E-120**



### FEATURES:

- Low-Profile, 3 vertical laminate teak stock
- RIFFE's signature Mag-Track
- RIFFE's Stainless 2-Piece Steel Trigger Mechanism with added silencer
- Side rotating spring loaded safety
- All models come stock with 9/32" (7.1mm) Hawaiian flopper Euroshaft with large tabs
- (2) 5/8" (16mm) black coated amber RIFFE Gorilla Rubber power bands with 1000 lb. Spectra wishbone line (accepts (3) 9/16" (14mm), (2) 5/8" (16mm) power bands)
- All models are rigged with 300 lb. abrasion resistant Nylon mono-filament shooting line for faster shots
- 5" Bungee Shock Chord with 500 lb. test Pigtail Swivel
- Automatic side mounted line release
- Reinforced bolted muzzle
- Heavy-duty reinforced glass filled Nylon handle with over molded

cushion grip

- Rear loading pad with full vision when aiming down the shaft
- Built in stainless steel threaded reel inserts, designed to fit the RIFFE Horizontal Reel - Flat mount

Optional Setups:

- Threaded Euro shafts
- Spearheads sold separately
- 400 lb. 5" Bungee Snap Swivel
- RIFFE Horizontal Reel

All models may be rigged to customer's preference when ordering. See pg.18 for all models' specs



**EURO X** models feature a 4" (10cm) rear stock extension for ease of hip loading and aids in faster swing. 90X, 100X, and 110X

## ENCLOSED TRACK EURO

RIFFE's unparalleled Low Profile EURO designed speargun is also available with an **ENCLOSED TRACK**. The laminated teak series is manufactured in a rectangular shape with radius corners for maximum beam strength. The enclosed track eliminates shaft whip when firing and aids in accuracy. IDEAL for FREE-SHAFTING and is very

effective when using smaller shafts and more powerful bands. All models come standard with threaded stainless steel reel inserts for mounting a reel.  
**E-100ET, E-100XET, E-110ET, E-110XET, E-120ET**



### FEATURES:

- Low-Profile, 3 vertical laminated teak stock
- RIFFE's Stainless Steel 2-Piece Trigger Mechanism with added silencer
- Side rotating spring loaded safety
- Comes standard with 9/32" (7.1mm) Hawaiian flopper Euroshaft
- (2) 5/8" (16mm) black coated amber RIFFE Gorilla Rubber power bands with 1000 lb. Spectra wishbone line (accepts (3) 9/16" (14mm), (2) 5/8" (16mm) power bands)
- 5" Bungee Shock Chord with 500 lb. test Pigtail Swivel
- All models are rigged with 300 lb. abrasion resistant Nylon mono-filament shooting line for faster shots
- Automatic side mounted line release
- Reinforced bolted muzzle
- Heavy-duty reinforced glass filled Nylon handle with over molded cushion grip

- Rear loading pad with full vision when aiming down the shaft
- Built in threaded reel inserts, designed to fit the RIFFE Horizontal Reel - Flat mount
- Removable/replaceable polyethylene track

Optional Setups:

- Threaded Euro shafts available in 17/64" (6.75mm), 9/32" (7.1mm) with Large shark fin tab
- Spearheads sold separately
- 400 lb. 5" Bungee Snap Swivel
- RIFFE Horizontal Reel
- Orange Track

All models may be rigged to customer's preference when ordering. See pg.18 for all models' specs

## SPEAR SHAFTS

**All RIFFE Spear Shafts** are made with USA 17-4 spring stainless steel, and heat treated to increase strength and shaft flex memory. Manufactured using computer numerical controlled (CNC) machines at the RIFFE factory headquarters in San Clemente, California. All Shark-Fin tabs, RIFFE's innovation, have a smooth finish capable of holding 1 to 2 power bands per tab. All shaft machined areas are hand finished providing a polished and premium product.

### AMERICAN SQUARE NOTCH SPEAR SHAFTS

- Large Tabs only
- Smaller shafts 50" (127cm) and under feature (2) Shark Fin Tabs.
- Shafts over 55" (140cm) feature (3) Shark Fin Tabs.
- All 1 1/32" (8.7mm) & 3/8" (9.5mm) shaft feature 4 Shark Fin Tabs.
- Custom shafts available. Minimum order required.



HAWAIIAN or TAHITIAN FLOPPER	28"/71cm	34"/86cm	44"/112cm	50"/127cm	57"/145cm	65"/165cm	72"/183cm
<b>9/32" (7.1mm)</b> *Large Tabs	HS-3460	HS-3480	HS-3490	HS-3500	HS-3505	HS-3515	HS-3529
<b>5/16" (8mm)</b> *Large Tabs				HS-3503	HS-3530	HS-3540	HS-3545
<b>5/16" (8mm) DOUBLE FLOPPER</b> *Large Tabs					HS-3530F	HS-3540F	HS-3545F

THREADED	26"/66cm	32"/81cm	42"/107cm	48"/122cm	53"/135cm	55"/140cm	59"/150cm	60"/152cm	65"/165cm	68"/173cm	72"/183cm
<b>9/32" (7.1mm) - 6mm Thread</b> *Large Tabs	S-3039	S-3040	S-3105	S-3115		S-3120		S-3125	S-3130		
<b>5/16" (8mm) - 24" Thread</b> *Large Tabs			S-3205	S-3215	S-3219	S-3220	S-3224	S-3225	S-3230		S-3240
<b>11/32" (8.7mm) - 24" Thread</b> *Large Tabs								S-3425	S-3430	S-3433	S-3435
									S-3430E 4TB+RT	S-3433E 4TB+RT	S-3435E 4TB+RT
<b>3/8" (9.5mm) - 24" Thread</b> *Large Tabs						S-3320		S-3325	S-3330		S-3340 S-3345 4TB+RT

**Rest Tab** - May be added to any shaft (RT-1000)  
A Rest Tab is a larger loading tab welded 12" (30.5cm) from rear of shaft to help make loading bands easier or for shorter target range shots.

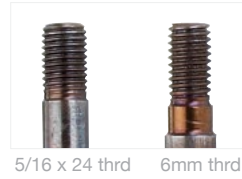

**M-TAB EURO STYLE SHAFTS** are manufactured for the Marauder speargun series and are compatible with all RIFFE Euro spearguns and most European sling style spearguns. Reduced length from last tab to end of shaft delivers extra stretch for maximum power.

**Shaft options:** Double Flopper and 6mm Threaded.

All barbs are passivated, heat treated for strength, and polished.

- Large Tabs only. 3 Tabs per shaft.
- Custom shafts available. Minimum order required.

Reduced length delivers maximum power



DOUBLE FLOPPER	51"/130cm	59"/150cm	67"/170cm
Speargun size	47	55	63
<b>19/64" (7.5mm) - Double Flopper</b> *Large Tabs Only	MT-4530FL	MT-4550FL	MT-4570FL
<b>5/16" (8mm) - Double Flopper</b> *Large Tabs Only	MT-4730FL	MT-4750FL	MT-4770FL

THREADED (6mm)	46"/117cm	54"/137cm	62"/157cm
Speargun size	47	55	63
<b>5/16" (8mm) - 6mm Thread</b> *Large Tabs Only	MST-4717L	MST-4737L	MST-4757L

**EUROSHAFTS** are manufactured for all European sling style spearguns.

**Shaft options:** Hawaiian (flopper on bottom) or Tahitian (flopper on top), Double Flopper and 6mm Threaded.

All barbs are passivated, heat treated for strength, and polished.

- 2 Tabs per shaft
- Breakdown/Travel Shafts available in 19/64" (7.5mm) with Shark Fin (Large) tabs only.
- Custom shafts available. Minimum order required.



Replacement Flopper, Barb and Rivets available

HAWAIIAN or TAHITIAN FLOPPER	34"/86cm	45"/115cm	51"/130cm	55"/140cm	59"/150cm	63"/160cm	67"/170cm	71"/180cm
Speargun size	55cm	75cm	90cm	100cm	110cm	120cm	130cm	140cm
<b>9/32" (7.1mm)</b> *Mini or Large (L) Tabs	ES-3386L	ES-3315(L)	ES-3330(L)	ES-3340(L)	ES-3350(L)	ES-3360(L)	ES-3370L	ES-3380L
<b>9/32" (7.1mm) DOUBLE FLOPPER</b> *Large Tabs Only				ES-3340FL	ES-3350FL	ES-3360FL	ES-3370FL	ES-3380FL
<b>19/64" (7.5mm)</b> *Large Tabs Only				ES-3540L	ES-3550L	ES-3560L	ES-3570L	ES-3580L
<b>19/64" (7.5mm) DOUBLE FLOPPER</b> *Large Tabs Only					ES-3550F(L)	ES-3560F(L)	ES-3570F(L)	
<b>19/64" (7.5mm) BREAKDOWN / TRAVEL - Hawaiian Only</b> *Large Tabs Only (LT)			ES-3530LT	ES-3540LT	ES-3550LT	ES-3560LT		

THREADED (6mm)	31"/79cm	42"/106.5cm	46"/117cm	50"/127cm	54"/137cm	58"/147cm	62"/157cm	66"/168cm
Speargun size	55cm	75cm	90cm	100cm	110cm	120cm	130cm	140cm
<b>9/32" (7.1mm) - 6mm Thread</b> *Large Tabs Only			EST-3317L	EST-3327L	EST-3337L	EST-3347L	EST-3362L	





## SPEAR TIPS

**RIFFE SLIP TIP ASSEMBLY** Used for shooting larger fish and helps prevent shaft bending and fish tearout. Unique milled pocket design keeps crimp level for a low profile, streamlined spear. Created for less resistance through the water while maintaining accuracy. Made from Heat Treated 17-4 Stainless Steel bar stock, CNC (Computer Numerical Controlled) machined and hand finished to debur sharp edges. Anti-locking tapered Adapter.

Sub-Mini and Mini Slip Tip come standard with Tandem Slide Ring featuring a swedged stainless steel ball stop at the end of the cable which enables the slide ring to exit the fish without hang up and includes Nylon coated 485 lb. 1/16" (1.9 mm) Hi-Flex Coated Cable 7x19. Standard Slip Tips are available with Loop Slide Ring or Tandem Slide Ring and includes 500 lb. 1/16" (1.9mm) S.S. Coated Cable 7x7. Spectra line upgrade available.



Standard Slip Tip TRI-CUT  
3/8" (9.5mm) dia. x 5.5"(14 cm)



Standard Slip Tip NEEDLE POINT  
3/8" (9.5mm) dia. x 5.5"(14 cm)



Mini Slip Tip NEEDLE POINT  
5/16" (8mm) dia. x 5"(12.7cm)



Sub Mini Slip Tip NEEDLE POINT  
9/32" (7.1mm) dia. x 3.25"(8.25cm)



Option to convert to Spectra on any Riffe Slip Tip H-10SPU

### NEEDLE POINT SLIP TIP ASSEMBLY

Sub Mini Slip Tip:  
Tandem Slide Ring  
9/32"(7.1mm) H-6001

Mini Slip Tip:  
Tandem Slide Ring  
9/32"(7.1mm) H-6003  
9/32"(7.1mm) H-6003S - Spectra  
19/64" (7.5mm) H-6004  
5/16"(8mm) H-6005

Slip Tip: Tandem Slide Ring  
9/32"(7.1mm) 6mm thrd H-6006  
5/16"(8mm) 24" thrd H-6007  
5/16"(8mm) 24" thrd H-6007S - Spectra  
5/16"(8mm) 6mm thrd H-6008  
11/32"(8.7mm) 24" thrd H-6009 } Blue Water Rig  
3/8" (9.5mm) 24" thrd H-6010 } 24" Cable

Slip Tip: Loop Slide Ring  
5/16"(8mm) 24" thrd H-6012  
11/32"(8.7mm) 24" thrd H-6014 } Blue Water Rig  
3/8" (9.5mm) 24" thrd H-6015 } 24" Cable

### ADAPTER

Sub Mini & Mini Slip Tip Adapter (only)  
6mm H-1604  
Slip Tip Adapter (only)  
6mm H-1605  
24" thread H-1606



### SLIP TIP RING LINE ASSEMBLY

(H-1035)  
Used to maintain Slip Tip tension on the adapter and aids in removing spearhead from fish.



### TRI CUT SLIP TIP ASSEMBLY

Mini Slip Tip:  
Tandem Slide Ring  
9/32"(7.1mm) H-6003TC  
19/64" (7.5mm) H-6004TC  
5/16"(8mm) H-6005TC

Slip Tip: (Tandem Slide Ring)  
9/32"(7.1mm) 6mm thrd H-6006TC  
5/16"(8mm) 24" thrd H-6007TC  
5/16"(8mm) 6mm thrd H-6008TC  
11/32"(8.7mm) 24" thrd H-6009TC } Blue Water Rig  
3/8" (9.5mm) 24" thrd H-6010TC } 24" Cable

Slip Tip: (Loop Slide Ring)  
5/16"(8mm) 24" thrd H-6012TC  
11/32"(8.7mm) 24" thrd H-6014TC } Blue Water Rig  
3/8" (9.5mm) 24" thrd H-6015TC } 24" Cable

### SLIP TIP ANATOMY

Needle Point Slip Tip Head  
Crimped Line  
Adapter  
Loop Slide Ring  
Ring Line Assembly

Tri-Cut Mini Slip Tip Assembly includes Adapter, Tandem Slide Ring and Ring Line Assembly

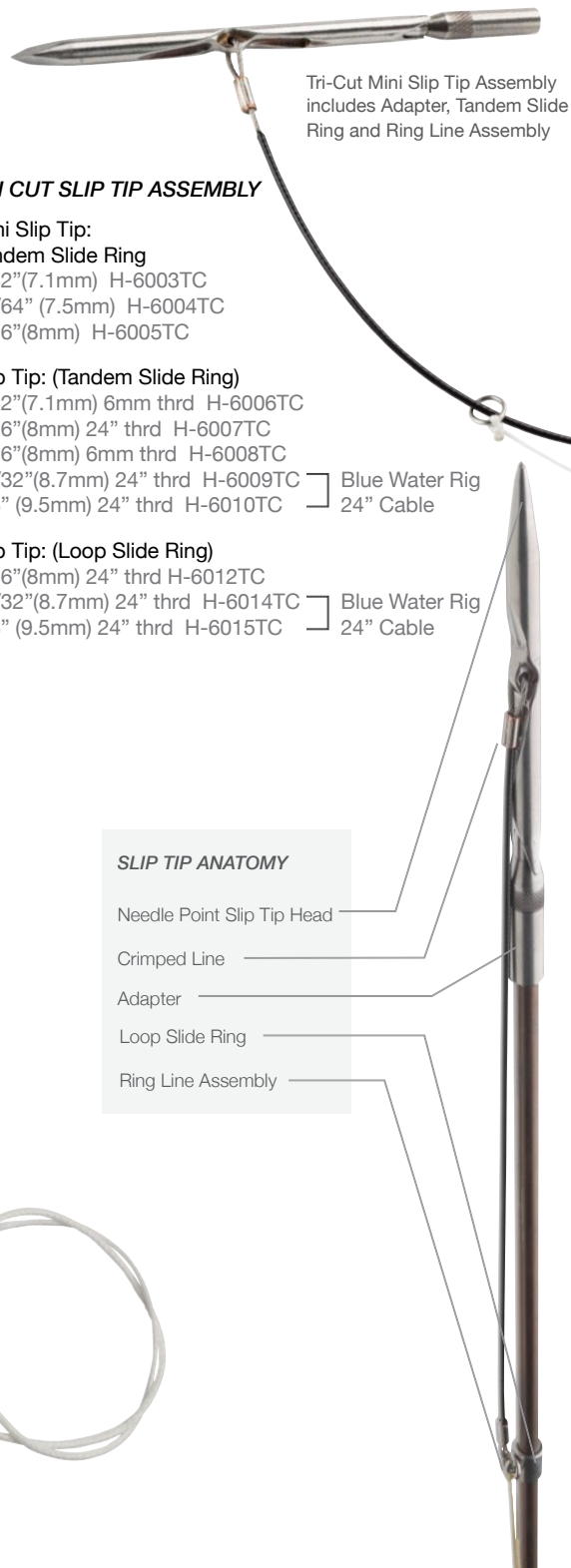

### TANDEM SLIDE RING

Stainless Steel Tandem Slide Rings allow a shorter overhang on shaft. Standard on SUB Mini and Mini Slip Tip.

Available sizes:  
9/32"(7.1mm) H-1049  
19/64"(7.5mm) H-1038  
5/16"(8mm) H-1041  
11/32"(8.7mm) H-1042  
3/8"(9.5mm) H-1046



### LOOP SLIDE RING

Available sizes:  
9/32"(7.1mm) H-1048  
5/16"(8mm) H-1040  
11/32"(8.7mm) H-1051  
3/8"(9.5mm) H-1045



Tandem Slide Ring with Ring Line Assembly shown installed on shaft

### RIFFE SPEAR TIPS

- A. Medium 2-barbed Tip  
Needle Point (6mm thread) - 3/8"(9.5mm) diameter (H-1005)
- B. Large 2-barbed Tip  
Quad Cut (5/16"-24 thread) - 7/16"(11mm) diameter (H-1010)
- C. Spearhead Adapter  
5/16" 24 thread - 6mm thread (H-1075)
- D. Spearhead Adapter  
6mm - 5/16" 24 thread (H-1080)

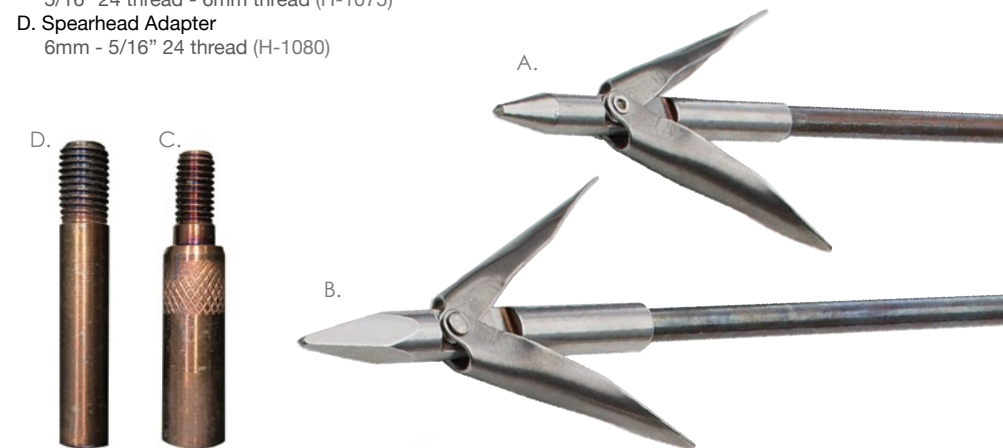

**SPECS**

	PART #	MODEL	STOCK LENGTH*	SHAFT & TIP STYLE (Hawaiian or Tahitian)		POWER BAND			SHOOTING RANGE		
				Shaft Diameter x Length	Shaft & Tip Style	Qty	Diameter	Length		Stretch**	
COMPETITOR	MC-0000	Mahogany #00	27" (69cm)	9/32" (7.1mm)	28" (71cm)	Hawaiian Flopper	2	9/16" (14mm)	12" (30.5cm)	16" (41cm)	5.5' (1.68m)
	MC-0002	Mahogany #0	33" (84cm)		34" (86cm)	Hawaiian Flopper	2		15" (38cm)	22" (56cm)	7.5' (2.29m)
	MC-0004	Mahogany #1	39" (99cm)		44" (112cm)	Hawaiian Flopper	2		18" (46cm)	28" (71cm)	9.5' (2.9m)
	MC-0006	Mahogany #2	45" (114cm)		50" (127cm)	Hawaiian Flopper	2		20" (51cm)	34" (86cm)	11.5' (3.51m)
	MC-0008	Mahogany #2X	48" (122cm)		50" (127cm)	Hawaiian Flopper	2		20" (51cm)	34" (86cm)	11.5' (3.51m)
	MC-0010	Mahogany #3	51" (129.5cm)		57" (145cm)	Hawaiian Flopper	2		24" (61cm)	40" (102cm)	13.5' (4.11m)
	MC-0012	Mahogany #3X	54" (137cm)		57" (145cm)	Hawaiian Flopper	2		24" (61cm)	40" (102cm)	13.5' (4.11m)
EURO	E-55	Euro 55	32" (81cm)	9/32" (7.1mm)	34" (86cm)	Hawaiian Flopper Shaft	2	5/8" (16mm)	15" (38cm)	22.5" (57cm)	10' (3m)
	E-75	Euro 75	40" (102cm)		45" (115cm)				18" (46cm)	30.5" (77.5cm)	15' (4.6m)
	E-90	Euro 90	46" (117cm)		51" (130cm)				22" (56cm)	37" (94cm)	18' (5.5m)
	E-90X	Euro 90X	50" (127cm)		51" (130cm)				22" (56cm)	36" (91.5cm)	18' (5.5m)
	E-100	Euro 100	50" (127cm)		55" (140cm)				24" (61cm)	40.5" (103cm)	20' (6.1m)
	E-100X	Euro 100X	54" (137cm)		55" (140cm)				24" (61cm)	39.5" (126cm)	20' (6.1m)
	E-110	Euro 110	54" (137cm)		59" (150cm)				26" (66cm)	44.5" (113cm)	22' (6.7m)
	E-110X	Euro 110X	58" (147cm)		59" (150cm)				26" (66cm)	43.5" (110.5cm)	22' (6.7m)
	E-120	Euro 120	58" (147cm)		63" (160cm)				30" (76cm)	48.5" (123cm)	24' (7.3m)
	EURO ENCLOSED TRACK	E-100ET	Euro 100 Enclosed Track		50" (127cm)				9/32" (7.1mm)	55" (140cm)	Hawaiian Flopper
E-100XET		Euro 100X Enclosed Track	54" (137cm)	55" (140cm)	24" (61cm)	40.5" (103cm)	20' (6.1m)				
E-110ET		Euro 110 Enclosed Track	54" (137cm)	59" (150cm)	26" (66cm)	44.5" (113cm)	22' (6.7m)				
E-110XET		Euro 110X Enclosed Track	58" (147cm)	59" (150cm)	26" (66cm)	44.5" (113cm)	22' (6.7m)				
E-120ET		Euro 120 Enclosed Track	58" (147cm)	63" (160cm)	30" (76cm)	48.5" (123cm)	24' (7.3m)				
EURO TRAVEL	EUROT-90	Euro Travel 90	46" (117cm)	19/64" (7.5mm)	51" (130cm)	Hawaiian Flopper	2	5/8" (16mm)	22" (56cm)	37" (94cm)	18' (5.5m)
	EUROT-100	Euro Travel 100	50" (127cm)		55" (140cm)				24" (61cm)	40.5" (103cm)	20' (6.1m)
	EUROT-110	Euro Travel 110	54" (137cm)		59" (150cm)				26" (66cm)	44.5" (113cm)	22' (6.7m)
	EUROT-120	Euro Travel 120	58" (147cm)		63" (160cm)				30" (76cm)	48.5" (123cm)	24' (7.3m)
MARAUDER	MD-1047	Marauder 47	47" (119cm)	19/64" (7.5mm)	51" (130cm)	Hawaiian Double Flopper	3	9/16" (14mm)	22" (56cm)	37" (94cm)	19.75' (6m)
	MD-1055	Marauder 55	55" (140cm)		59" (150cm)				26" (66cm)	45" (114cm)	23.75' (7.24m)
	MD-1063	Marauder 63	63" (160cm)		67" (170cm)				32" (81cm)	52.25" (132.7cm)	27.25' (8.31m)
	MD-1063S	Marauder 63S	63" (160cm)	5/16" (8mm)	62" (157cm)	Threaded (6mm) / Mini Slip Tip		5/8" (16mm)	32" (81cm)	52.25" (132.7cm)	27.25' (8.31m)
RAIDER	R-1055	Raider 55	55" (140cm)	5/16" (8mm)	53" (135cm)	Threaded (24"thrd) / Slip Tip	3	5/8" (16mm)	26" (66cm)	46" (117cm)	25' (7.6m)
	R-1061	Raider 61	61" (155cm)	5/16" (8mm)	59" (150cm)	Threaded (24"thrd) / Slip Tip	3	5/8" (16mm)	30" (76cm)	52" (132cm)	28' (8.5m)
	R-1067	Raider 67	67" (170cm)	11/32" (8.7mm)	65" (165cm)	Threaded (24"thrd) / Rest / Slip Tip	4	5/8" (16mm)	32" (81cm)	58" (147cm)	30' (9.1m)
	R-1070	Raider 70	70" (178cm)	11/32" (8.7mm)	68" (172cm)	Threaded (24"thrd) / Rest / Slip Tip	5	5/8" (16mm)	34" (86cm)	61" (155cm)	32' (9.7m)

\* Stock Length is the measurement of gun stock including Butt End Assembly

\*\* Power Band Stretch is measured from inner muzzle slot to the front of mechanism



## CARBON FIBER POLE SPEAR

RIFFE **CARBON FIBER POLE SPEARS** were designed for open water hunting. An optimal balance of weight and strength is achieved by using carbon fiber. Lightning fast shots conduct momentum while maintaining the punch to take down world record fish. This is truly an exceptional pole spear with unparalleled performance.

Eight varying size sections are available for a tailor made pole spear specifically for your spearfishing objective and varying hunting options.

A tapered javelin style front and back section provide optimum maneuverability. Front section rod features a strengthening fiberglass insert and a no slip handle grip. Nose at front end piece has a flat for securing spear shaft and sections.

Recommended tools for assembly: 3/8" (10mm) and 9/16" (14mm) open end wrenches, vice grip pliers for tightening or removing the spearshaft.

**\*\* NOTE:** For hunting around wrecks, caves, ledges, etc., we highly recommend using the Sub-Mini Slip Tip Extended Breakaway assembly. This setup will help prevent fish from pulling the pole spear into such obstacles and damaging your gear. Front section is reinforced to help prevent breakage and damage due to impact. Pole spears can break under these conditions. If pole spear is broken or damaged by impact of structures and caves, warranty is void.

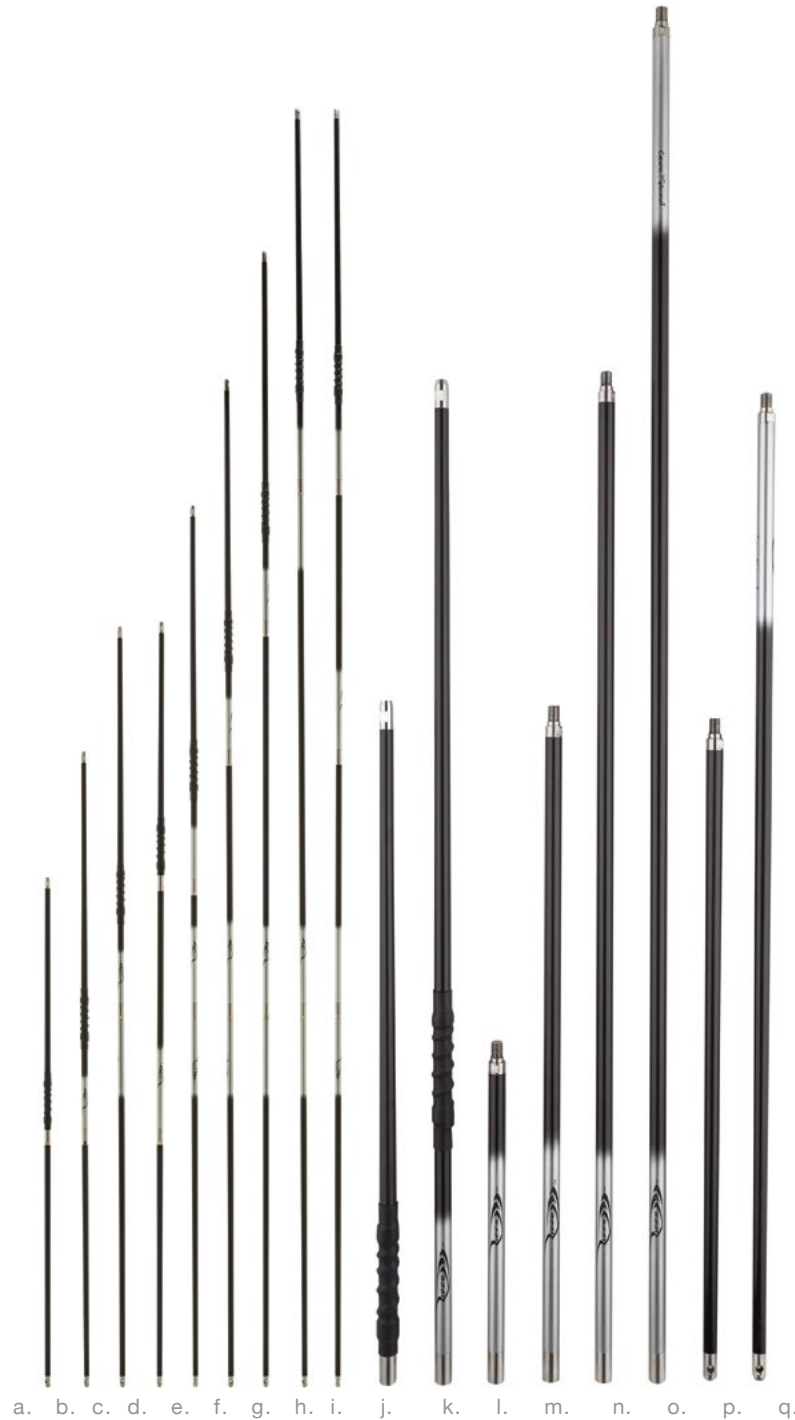

6 Foot Pole Spear package (RPS-062)

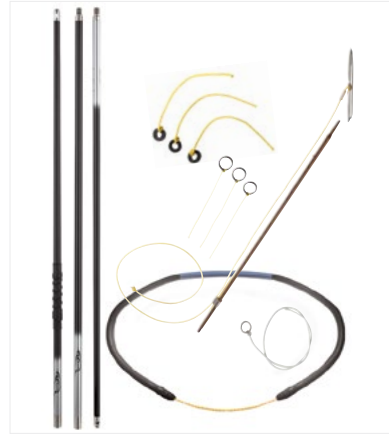

9 Foot Pole Spear package (RPS-093)

### Custom build to any length

- |                         |         |
|-------------------------|---------|
| a. 4 ft. (1.21 meters)  | } 2 pc. |
| b. 5 ft. (1.52 meters)  |         |
| c. 6 ft. (1.82 meters)  |         |
| d. 6 ft. (1.82 meters)  | } 3 pc. |
| e. 7 ft. (2.13 meters)  |         |
| f. 8 ft. (2.43 meters)  |         |
| g. 9 ft. (2.74 meters)  | } 4 pc. |
| h. 10 ft. (3.04 meters) |         |
| i. 10 ft. (3.04 meters) |         |

### Available Pole Spear Sections:

- |                 |                                 |
|-----------------|---------------------------------|
| j. 24" (61cm)   | } Tapered Front Section w/ grip |
| k. 36" (91.5cm) |                                 |
| l. 12" (30.5cm) | } Straight Mid Section          |
| m. 24" (61cm)   |                                 |
| n. 36" (91.5cm) |                                 |
| o. 48" (122cm)  | } Tapered Back Section          |
| p. 24" (61cm)   |                                 |
| q. 36" (91.5cm) |                                 |

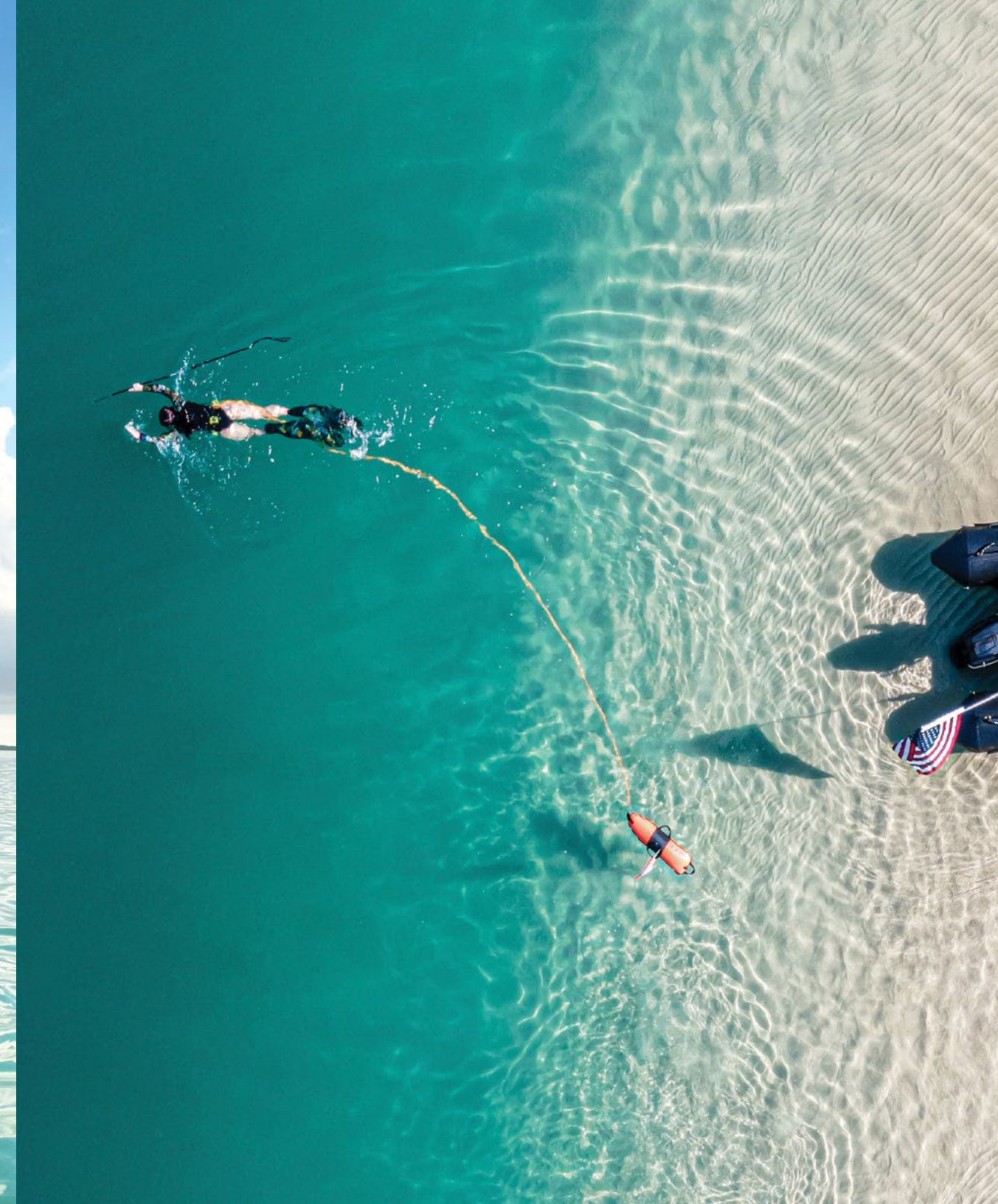
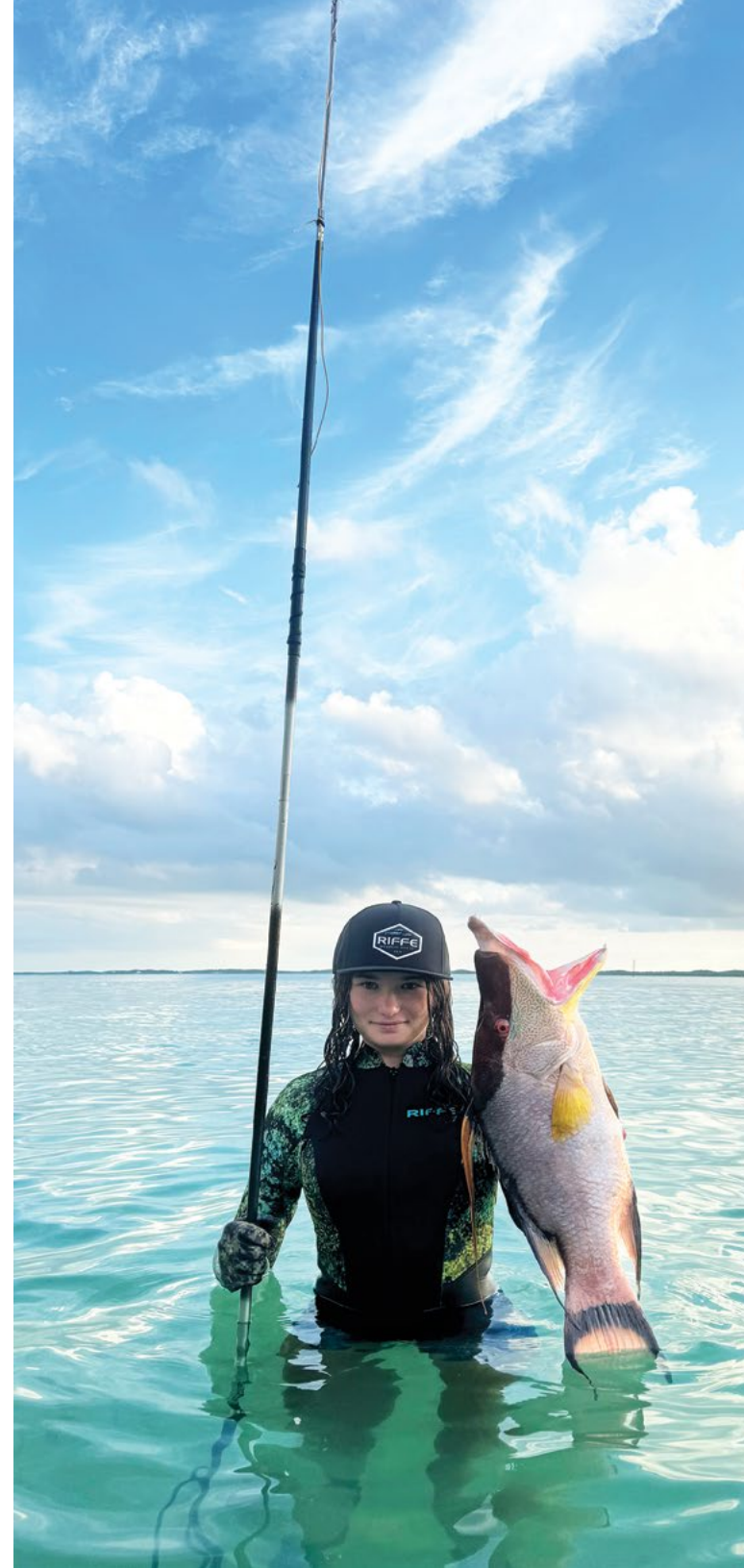

**POLE SPEAR ASSEMBLIES**

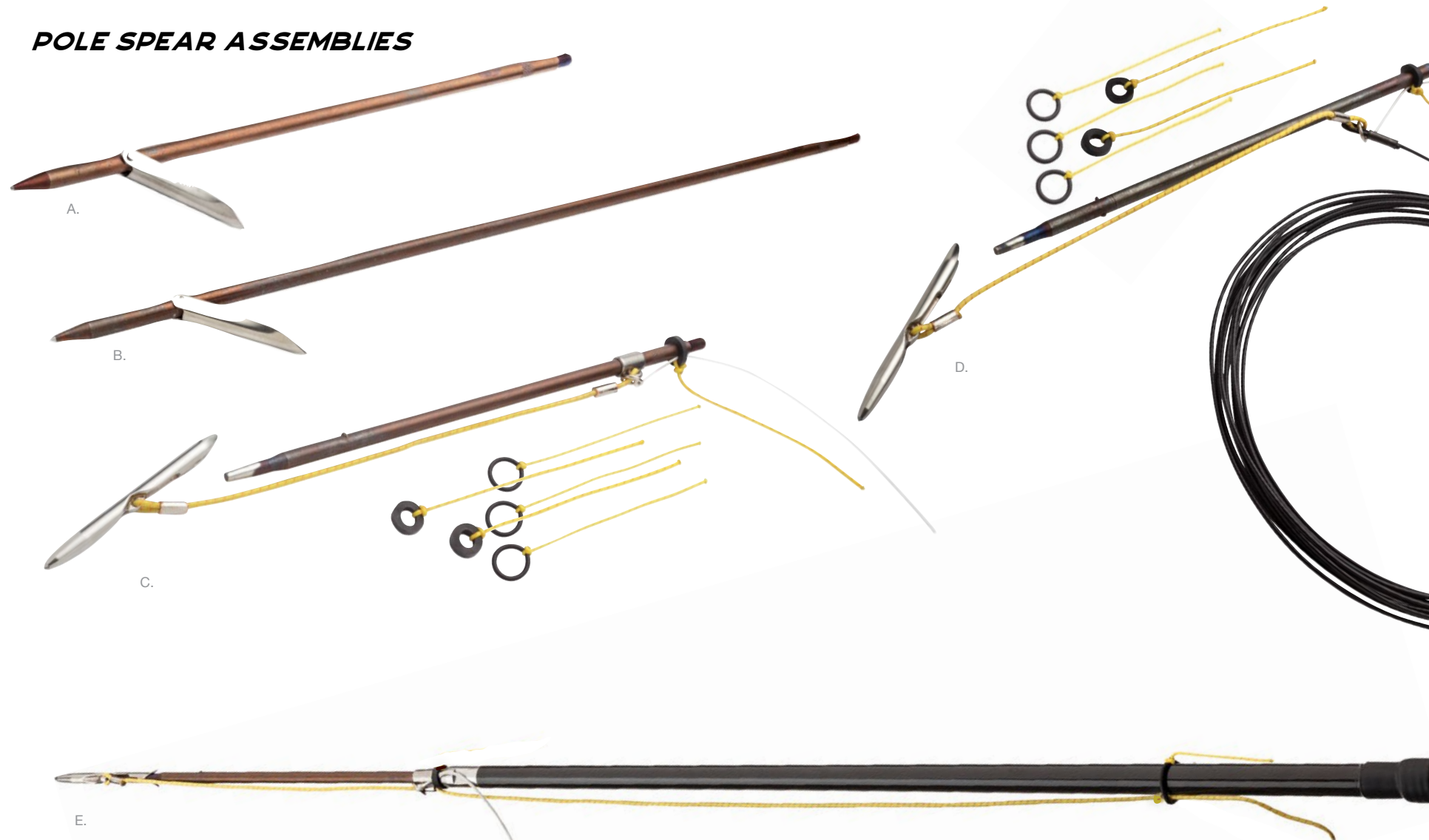

**A.** 9/32" (7.1mm) x 12" (30.5cm) Single Flopper Hawaiian Pole Spear Shaft (RPS-3100)  
**B.** 9/32" (7.1mm) x 18" (46cm) Single Flopper Hawaiian Pole Spear Shaft (RPS-3105)  
**C.** 9/32" (7.1mm) Sub-Mini Slip Tip Assembly 16" (25.4cm) nose piece shaft adapter with loop slide, 3 rubber keepers, 3 O-rings (RPS-H20-16) - with 10" (25.4cm) shaft adapter (RPS-H20)



Breakaway setup shown.

**POLE SPEAR PARTS**

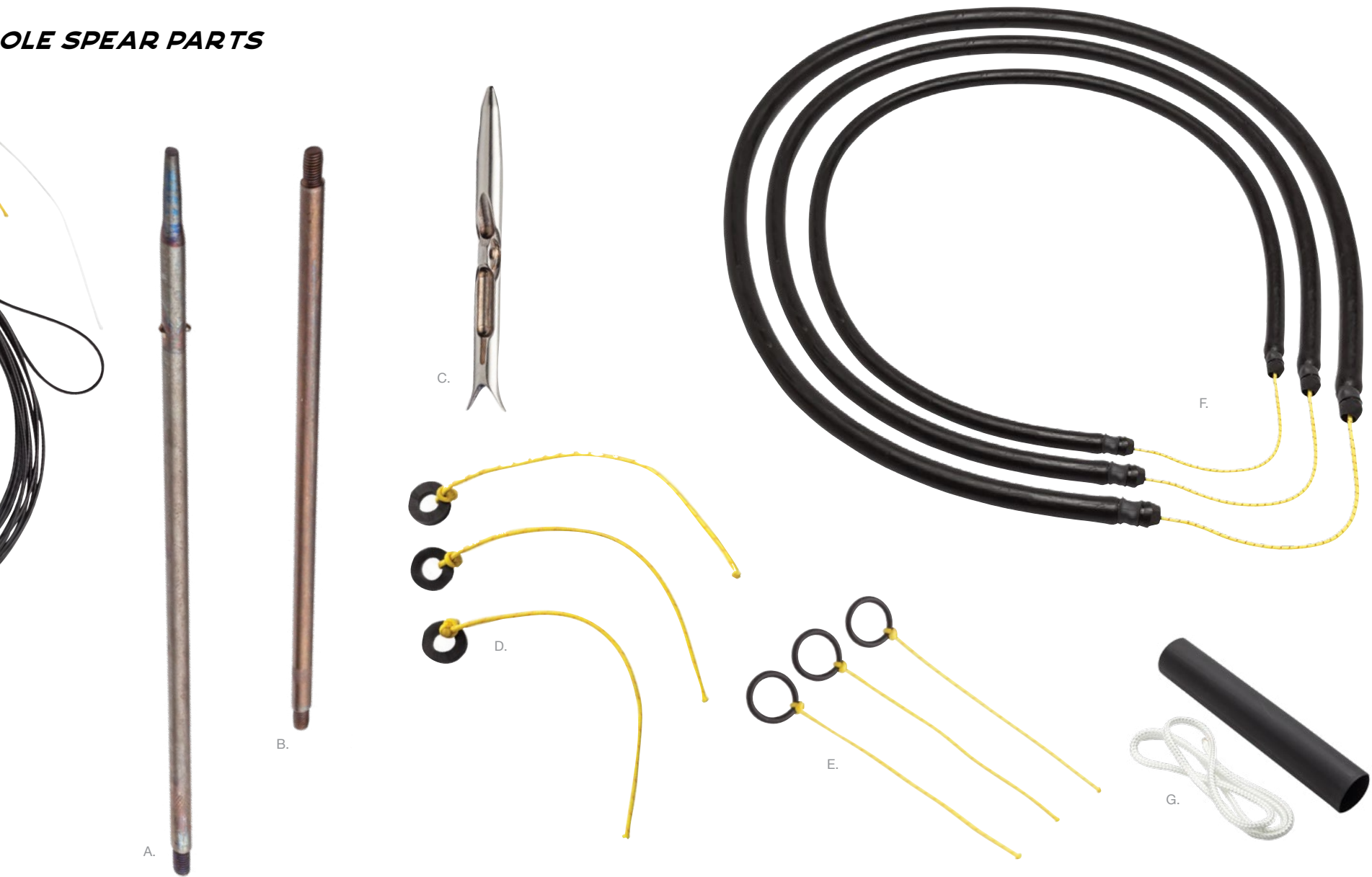

**A.** 9/32" (7.1mm) x 16" (40.5cm) Injector Rod (6mm thread) (RPS-A20)  
**B.** 9/32" (7.1mm) x 10" (25.4cm) Threaded Shaft Adapter (6mm thread both ends) (RPS-3200)  
**C.** Sub-Mini Slip Tip (only) (RPS-H20T)  
**D.** Rubber Ring Line Assembly for Sub-Mini Slip Tip (3) (RPS-RL01)

**E.** O-ring replacements line keeper (3) (RPS-OR1)  
**F.** 3/8" (9.5mm) Pole Spear Power Bands with vinyl grip (PP-5000 thru PP-5025)  
**G.** Self Adhesive Shrink Tube Grip Assembly (RPS-GR01)



Teflon Tape recommended to secure joints.



## REELS

**HORIZONTAL REELS** - Reels are best used in shallow water where current is flowing or around structure that would tangle float lines or cause too much drag to dive effectively. Diving in kelp, around oil rigs, shipwrecks, jetties and bridges are some environments in which you would benefit from using a reel.

If blue water hunting, a reel works well for paddy hopping, shooting smaller fish like mahi-mahi, yellowtail, small wahoos, uluas, etc.

Low-profile designs made of composite materials (Nylon-Fiberglass) including heat treated aluminum parts with a hard anodized surface. Lighter weight and lower profile aid in quicker tracking and maneuverability.

### FEATURES:

- Compact and Light weight - Low Pro (6 oz.) Original - (6.5 oz.)
- The only reel on the spearfishing market with a 4 drag position slide lever control.
  - Stop#1 : Free spool
  - Stop#2 : Light drag
  - Stop#3 : Medium drag
  - Stop#4 : Heavy drag

*Foolproof Drag System . Easy line retrieval . Light weight . Glass filled Nylon . Corrosion Resistant*

- Stainless Steel bail to prevent line tangle
- Assembled with 10-24 Screws for mounting on RIFFE Euro Series and other RIFFE models using Threaded Inserts or may be mounted with wood screws placed in a pre-drilled hole

### 2 sizes to choose from:

- **Low-Pro** - Holds up to 125 ft (38 m) x 272 kg (600 lb.) Spectra line
- **Original** - Holds up to 200 ft (60 m) x 272 kg (600 lb.) Spectra line

Mounts on all RIFFE spearguns as well as other manufacturers that feature similar barrel shapes. Fits on flat and radial gun stocks with proper mounts.

### THE BEST REEL DESIGN ON THE MARKET

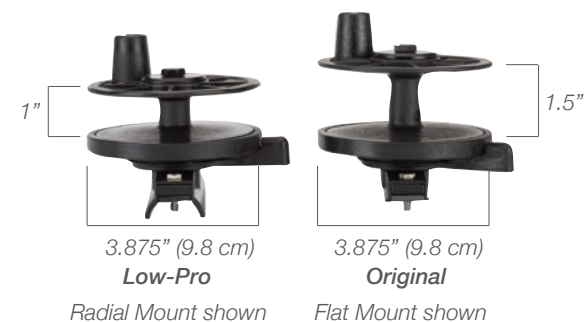

Original Horizontal Reel (RL-1510)  
Shown with line and FLAT MOUNT



Low-Pro Horizontal Reel (RL-1610R)  
Shown with line and RADIAL MOUNT



Reel Belt Adapter (RL-1013)  
Converts Reel for use on Weight Belt



### SPECTRA REEL LINE

With numerous reel line options on the market, choosing can be difficult. Our 600 lb. Spectra Line is exclusively designed and manufactured for RIFFE. This line is robust, durable and built to last, featuring a straight multi-strand core wrapped in a 100% Spectra outer woven sheath. Unrivaled quality created to endure the toughest spearfishing conditions. Made in the USA. Sold per/ft & spools of (125 ft (38 m) L-1007) (200 ft (60 m) L-1006)



Horizontal Reel - FLAT MOUNT  
\*\* Used on RIFFE Euro, Marauder & Raider Series  
Original (RL-1500 no line) (RL-1510 w/ 200 ft. Spectra Line)  
Low Pro (RL-1600 no line) (RL-1610 w/ 125 ft. Spectra Line)



Horizontal Reel - RADIAL MOUNT  
\*\* Used on all RIFFE radius barrel spearguns  
Original (RL-1500R no line) (RL-1510R w/ 200 ft. Spectra Line)  
Low Pro (RL-1600R no line) (RL-1610R w/ 125 ft. Spectra Line)

**Must specify Radial mount and machine or wood screws, if needed when ordering (Horizontal Reels).**

## SPEARGUN KITS



Bolted Muzzle Reinforcement Kit



### BOLTED MUZZLE REINFORCEMENT KIT

(K-7000) and (K-7050 Euro series)  
Reinforces the muzzle when adding power. Recommended when using 4 bands. Comes standard on all Euro Series, #Island, #W Blue Water and #4 and #5 Standard Series.

### WOOD MAINTENANCE KIT (KM-1000)

Part 1 penetrating, part 2 laminating wood maintenance kit. Includes (2)40, (2)80, (2)600 grit sand paper and instructions. (2)oz bottles



# SPEARGUN PARTS



- A.** Line Breakaway Assembly (L-6000)(Not used on Euro)
- B.** Line Breakaway Assembly (Bungee only) (L-6005)
- C.** 5" Bungee Shock Cord w/ Snap & Swivel w/680 lb. Nylon (L-6012) (Also used for Euro Breakaway)
- D.** 5" Bungee Shock Cord w/ Pigtail Swivel w/680 lb. Nylon (L-6010) (Also used for Euro Breakaway)
- E.** Velcro Strap (Float Line) Small (L-4002)
- F.** Velcro Strap (Float Line) Large (L-4001) (Gun Stock/bands) (L-4000)
- G.** Tip Protectors (H-4000)
- H.** Shackle (A-1000)
- I.** Snap Swivel - 450lbs. (A-1022)
- J.** Pigtail Swivel - 550lbs. (A-1020)
- K.** Quick Clip (L-1020)
- L.** Ballbearing Swivel (A-1015)
- M.** Fish Stringer & Quick Clip (S-1000)



**LINE BREAKAWAY ASSEMBLY** – Primarily used for blue water hunting with a float line bungee to surface float (L-6000)



**EURO BREAKAWAY** – When using line Breakaway assembly on Euro spearguns, move front 5" bungee to rear on shooting line. New 3' (.91m) longer line setup must be used. (L-6100)

- A.** Handle Assembly; Heavy Duty ABS Plastic (G-1000) (Competitor)
- B.** Handle Assembly Soft Grip; Heavy Duty reinforced glass filled Nylon handle with over molded cushion grip (G-1015) (Mid-Handle/Standard); (M-7040/M-7041) (Metal Tech Mid-handle/Metal Tech Rear handle)
- C.** Handle Assembly Soft Grip; Heavy Duty reinforced glass filled Nylon handle with over molded cushion grip (G-1020) (Euro)
- D.** Butt End Assembly (B-1015R) (Euro)
- E.** Butt End Assembly (B-1015B) (Euro)
- F.** Butt End Assembly (B-1000)
- G.** Butt End Assembly (B-1005) (Competitor)
- G.1** Butt End Assembly (B-1012) (Marauder)
- H.** Front Line Guide Plate Assembly (A-1035)
- I.1.** Complete Line Release Assembly (D-1025) (Comps,#1-3 Standard, #B-N Mid Handle) (D-1026) (#1,#W,#4,#5,& Euro)
- I.2.** Line Release Assembly (D-1000)(#1,#W,#4,#5,& Euro)
- I.3.** Line Release Assembly (D-1005)(Comps,#1-3 Standard #B-N Mid Handle)
- I.4.** Line Release Spring Only (D-1010)
- J.** Line Anchor w/ Screws (A-1040)(
- K.** Trigger (only) (T-1010)
- L.** Sear (T-1015)
- M.** Sear Rivet (T-1025), Trigger Rivet (T-1030)
- N.** Spring (T-1020)
- O.** Trigger Mechanism Assembly (T-2000) (Euro/Marauder)
- P.** Trigger Mechanism Assembly (T-1000) (Competitor)

\*\*All parts made from stainless steel

# POWER BANDS & SHOOTING LINE

**RIFFE's POWER BANDS** are made of "Gorilla Rubber", the highest modulus power band material available as tested. Contains antioxidants for longest life.

Available in sizes: 3/8" Diameter (9.5mm) for pole spear, 1/2" Diameter (13mm), 9/16" Diameter (14mm), 5/8" Diameter (16mm), 3/4" Diameter (19mm)

*\*\*Need power bands for a specific speargun model? Refer to chart on Page 18.*

- A1.** Black/Amber power band
- A2.** Amber power band
- B.** Tie In power band (available in black only)
- C.** Power bands available in bulk length
- D.** Spool Wax Band Tying Line (125 yd. spool) (L-7010)
- E1.** Dual sheath Spectra Wishbone (1000lb.) (3 pack)
- E2.** Dual sheath Spectra Tie In Wishbone (1000lb.) (3 pack)

## Shooting Line

- K.** 750 lb. (340kg) 5/64" (2mm) 7x7 S.S Non-Coated Cable / 500 lb. (227kg) 1/16"(1.6mm) 7x7 S.S. Non-Coated Cable
- L.** 500 lb. (227kg) 1/16"(1.6mm) - 3/32"(2.4mm) 7x7 S.S. Nylon Coated Cable or 485 lb. (218kg) 1/16"(1.6mm) - 3/32"(2.4mm) 7x19 Hi-Flex Nylon Coated Cable
- M.** 270 lb. (122kg) 3/64"(1.2mm) - 1/16"(1.6mm) S.S. Nylon Coated Cable
- N.** 400 lb.(182kg) Monofilament - 5/16"(8mm), 11/32" (8.7mm), 3/8"(9.5mm) shafts
- O.** 300 lb.(136kg) Monofilament - 9/32"(7.1mm) & 5/16"(8mm) shafts
- P.** 250 lb.(113kg) Monofilament - 17/64"(6.75mm) shafts.
- Q.** 600 lb. Spectra Reel Line - 1.8mm

*\*\* All shooting line is available in Bulk lengths*

## Crimps: (10 per pack)

- F.** 485/500/750 lb. Cable & 1000 lb. Spectra (aluminum) (L-5020)
- G.** 250 lb. Mono & 600 lb. Spectra (aluminum) (L-5005)
- H.** 300/400 lb. Mono Crimp (copper) (L-5010)
- I.** 270 lb. Cable Crimp (copper) (L-5000)

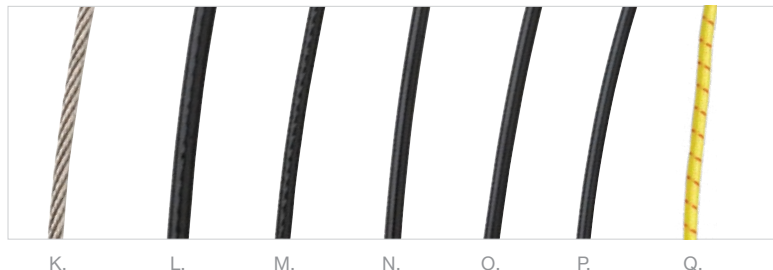

## DIVING KNIVES

All RIFFE's knife blades are made with 420 heat-treated stainless steel & Teflon coated, capable of cutting through Stainless Steel Cable, Monofilament, and High-Tech line. All RIFFE Knives are Teflon coated for corrosion resistance. Carries in a rugged nylon locking sheath.

All Knives include Sheath, Knife Lanyard & Rubber leg straps  
Optional Accessories: Forearm/leg Stretch Straps

**EDC 3.5 KNIFE** (RN-5300)  
- 3.5" 420 HT SS Blade  
- 8" Overall Length

**EDC 4.5 KNIFE** (RN-5200)  
- 4.5" 420 HT SS Blade  
- 8.5" Overall length

**WRANGLER 3.5 KNIFE** (RN-4300)  
- 3.5" 420 HT SS Blade  
- 7.5" Overall Length

**WRANGLER 4.5 KNIFE** (RN-4200)  
- 4.5" HT SS Blade  
- 9.5" Overall length

**WRANGLER 4.5 DUAL SERRATION KNIFE** (RN-4200D)  
- 4.5" 420 HT SS Blade  
- 9.5" Overall Length



### KNIFE ACCESSORIES

1. Knife Lanyard (RN-1005)
2. Knife Stretch Straps (forearm/leg, set of 2) (RN-1006)
3. Rubber Leg Straps (set of 2) (RN-1007)
4. a. Plastic Sheath - Wrangler 4.5, EDC 4.5 (RN-1012)  
b. Plastic Sheath - Wrangler 3.5, EDC 3.5 (RN-1013)

RN-4200 Shown with Lanyard, Sheath, Rubber Leg Straps & optional Stretch Straps



Handle your diving business with the EDC knife. An Every Dive Carry companion designed with grit and strength to withstand rough marine conditions. High visibility, Safety Orange PyraGrip textured handle offers a secure hold. 420 heat treated stainless steel blade, capable of cutting through stainless steel cable comes Teflon coated for corrosion resistance. Carries in a rugged nylon locking sheath.



## FLOAT SYSTEMS

### TRULY IN A CLASS OF ITS OWN...

#### 3 Atmosphere Float (F-1010)

The RIFFE 3 Atmosphere Torpedo Float is designed to **maintain lift up to a maximum of 95 lbs at a depth of 66 ft and flotation beyond 100ft.** Pressurize up to 25 lbs PSI. Ultra-durable vinyl coated 320 lb./sq. vinyl coated tear strength outer layer (22oz). Inner replaceable urethane bladder has a reinforced 1000lb. Denier nylon casing to maintain equal pressure throughout the bladder. Side zipper and (5) reinforced 1 1/2" Nylon straps with stainless steel buckles grant access to the inner replaceable urethane bladder. Soft lead may be added when using flag. Folds up to (14" x 14" x 2" = 4 lbs) for easy transporting.



Heavy duty marine grade stainless steel buckles



Air gauge and air blower adapter included w/float

#### Special Features:

- **Inflated Dimensions - 39" length x 12" width x 11.75" height x 12" girth** • 33 Liter • Inner urethane bladder reinforced with 1000lb. Denier nylon casing and nylon belted straps • Side zipper for access to inner bladder. (5) Heavy duty marine grade stainless steel buckles with 1 1/2" nylon straps reinforcing zipper. Two side handles, one rear handle, stainless steel D ring • includes emergency flair holder (flair not included) • Set up to use a flag & ballast weight of 3 lbs lead shot (flag & weight not included) • Air Pressure Gauge, Schrader Core removing tool and extra Schrader Core included • May be filled by either an air compressor, scuba tank, or simply by using a bicycle pump. Be sure to use an air pressure gauge while inflating. Excess pressure may damage the float (see warning below). Safety orange color. Suggested filling method: Orally inflate to fill volume of float, then complete with compressor or scuba tank.



#### WARNING:

Excessive heat may increase pressure in float causing rupture. Do not store inflated float in hot environment temperature when filling to allow for expansion/contraction. When filled with cold compressed air, pressure will increase with temperature increase. Fill slightly less than 25psi in a hot environment. Check float air pressure 20 minutes after inflating to ensure pressure has not exceeded 25psi.



#### P1 Utility Float (Single Popper) (F-2600)

#### P2 Utility Float (Double Popper) (F-2605)

The P1 Utility Float is your tag along float for shore diving and spearfishing. Orally inflate to use as a marker or deploy the CO2 cartridge (not included). Sometimes you need a little lift and assist while retrieving fish at depth. This float's shining feature is its capability to accept one or two CO2 cartridges (not included) for quick inflation. Swiftly deploy the float with a pull of a chord. Oral inflation is simply achieved by using the Push Stem Valve.

- Marker float while diving
- Clip speargun to float
- Wear on weight belt with the Float Holder (sold separately) and deploy at depth to assist with fish retrieval out of kelp or caves. A straightened line keeps the pressure on.
- Includes Safety Whistle



P1 Utility Float



P2 Utility Float

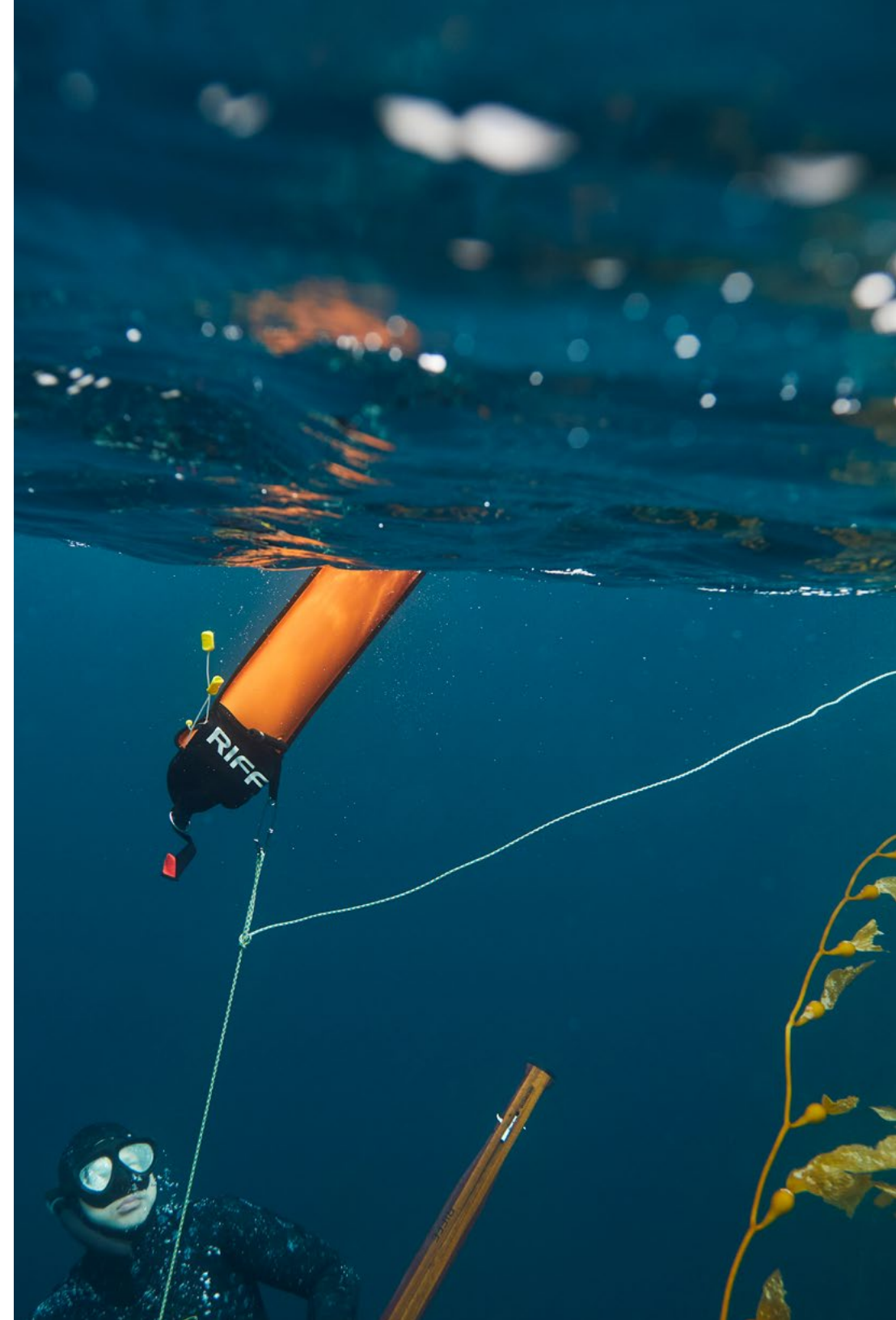

## FLOAT SYSTEMS

### TORPEDO PRO

RIFFE's 20L Torpedo Pro 15 psi open water float is a classic multifunction float. Upgraded Schrader stem valve makes inflation convenient with a simple bicycle pump or at any gas station with air fill capacity. Over pressure dump/release valve keeps the float at ideal pressure and is a cinch to deflate with the pull of a tab. Safety is always a top priority. Constructed in RIFFE's signature high visibility orange 840D nylon, the Torpedo Pro comes standard with a diver down flag and base for increased safety. Neoprene bottom pouch accommodates 2 lbs. (1kg) weight for steadfast ballast. Corrosion resistant stainless steel D-ring at front, webbing straps on sides and aft allow for multiple attachments of additional gear. Ideal as spear gun breakaway float for large fish hunting or chase float.

#### Features:

- Maximum Lift Capacity: 53 lbs. (24kg) @ 2ATM
- 15 PSI Inflation Pressure
- Over pressure dump/release valve prevents float from overinflation. Simply deflate with the pull of a tab.
- Includes Diver Down Flag & base for safety
- Bottom pouch holds 2 lbs. (1 kg) weight for ballast stability
- High visibility orange 840D nylon Industrial Strength Schrader Stem Valve - convenient inflation with bicycle pump or at any gas station.
- Stainless steel D-ring for strength and corrosion resistance.
- Webbing straps at sides and back
- Ideal as spear gun breakaway float for large fish hunting or chase float.

Dimensions (Lx W x H) when inflated:  
34" x 9.5" x 9" (86 cm x 24 cm x 23cm)

F-2500 Torpedo Pro Divers Float w/ Red+White Flag  
F-2505 Torpedo Pro Divers Float w/ Alpha Flag

- A. Alpha Flag (F-1015)
- B. Diver Down Flag (F-1014)
- C. Flag Base (F-1016)

NOTE: Recommend RIFFE's 3ATM Float for blue water hunting. Torpedo Pro may be used in combination for larger game fish.



Schrader stem valve

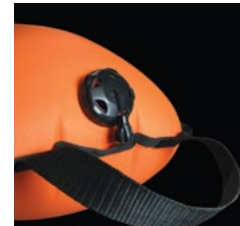

Over pressure dump/release valve



Neoprene weight pocket

### SPECTRA FUSION FLOAT LINE

RIFFE's Spectra Fusion Float Line is manufactured from a proprietary custom blend of material, developed exclusively for Riffe with improved strength and durability. This well engineered, extremely abrasion resistant specialty float line creates minimal drag making it highly effective in and around rock ledges and reef where float lines are prone to damage. These are dogtooth tuna hunter favorites.

- Yellow/blue outer sheath is composed of 32 strands fused together, coated with molten polyethylene for an abrasion and colorfast/UV resistant protective sheath.
  - Added internal middle braid ensures constant high test strength.
  - Upgraded foam rubber float core increases buoyancy making retrieval and line location as effortless as possible. Unlike other float lines on the market made of polypropylene that end up sinking, Riffe's Spectra Fusion Float Line stays on the water for optimum visibility.
  - Unrivaled float line built to perform. Tensile strength as tested including hardware (shackle, Quick Clips, and crimps) 800lbs. (365kg) plus.
- Available lengths: 25 ft (7.6M) LA-5000, 50 ft (15.2M) LA-5005, 75 ft (22.8M) LA-5010, 100 ft (30.4M) LA-5015

### VINYL FLOAT LINE

The most versatile of securing systems. Vinyl Float Lines can be used with or without buoys and in almost any dive situation. A float line allows you to shoot at any depth and let go of your gear for a free ascent to the surface. With your spear gun and shaft (or just the shaft with a break away rig) attached to a float line and then to a buoy on the surface, you can fight fish from the surface.

Includes stainless steel parts; (2) Quick Clips, (2) Shackles, (2) Swivels.  
Available lengths:  
25 ft (7.6M) L-4020TB (Tahitian blue), L-4020OR (orange)  
50 ft. (15.2M) L-4015TB (Tahitian blue), L-4015OR (orange)  
75 ft. (22.9M) L-4010TB (Tahitian blue), L-4010OR (orange)  
100 ft. (30.4M) L-4005TB (Tahitian blue), L-4005OR (orange)

### BLUE WATER BUNGEE

The RIFFE bungee stretches 2 1/2 times its length. The 680lb (308kg) test Nylon line core is triple the length of the bungee and when a fish is speared the line will stretch as the fish fights causing more and more drag. This allows resistance which effectively fights the fish without causing too much pressure which may tear soft flesh fish. For blue water hunting larger pelagic fish a bungee float line is a must. Highest grade material. Includes stainless steel parts; (2) Quick Clips, (2) Shackles, (2) Swivels. Black only.

Available lengths: 25ft (7.6m) B-4030, 50ft (15.2m) B-4035, 75ft (22.9m) B-4040, 100ft (30.5m) B-4045

Use separately or a vinyl / bungee combination  
\*\*\*Blue Water Bungee Float Lines are not for use around sharp surfaces.

NOTE: For blue water hunting (large pelagic fish) we recommend using Spectra Fusion float line in combination with a 25' Bungee float line.





## MASKS

All masks are not created equal. Made of supple, durable silicone rubber, our masks are some of the most comfortable and form fitting on the market. Unsurpassed quality in materials.

- Heat treated silicone rubber reduces fogging
- Durable Nylon frame for superior strength.
- Tempered glass lenses
- Hard protective case included
- Optical lenses available (Mantis, Viso/Naida)

### 2 Tempered glass lens options:

- CLEAR standard
- AMBER for increased light, higher contrast and better separation in low visibility

### MASK COMPARISON/SPECIFICATION CHART

MASK	VOLUME	FRAME LENGTH	FRAME HEIGHT
RECON	130ml	5.9in/151mm	2.875in/73mm
NEKTON	100ml	5.8in/147mm	3in/76mm
MANTIS 5	177ml	7.05in/179mm	3.35in/85mm
MANTIS	202ml	7.05in/179mm	3.35in/85mm
VISO	164ml	6.22in/158mm	2.75in/70mm
NAIDA	130ml	6.5in/165mm	2.75in/70mm
FRAMELESS	226ml	6.3in/150mm	3.35in/85mm



No hassle quick release mask strap buckle.



- White/Clear Lens MA-090W
- Caribbean Blue/Clear Lens MA-090C
- Black/Clear Lens MA-090 Lens
- Black/Amber Lens MA-091

### NEKTON

Our lowest volume design, sleek and compact. Created with the freediver in mind. Comfortable and form fitting low volume skirt. Tear drop glass lens shape offers a wider vision span.



- Black/Clear Lens MA-060
- Black/Amber Lens MA-061

### FRAMELESS

A single, non-replaceable lens. Fits a *variety* of face shapes.





- Black/Clear Lens MA-050
- Black/Amber Lens MA-051

### NAIDA

Low volume, fitting *medium to wide* face shapes. Optical lenses available upon request.



-  Silver/Clear Lens MA-020S
-  Black/Clear Lens MA-020
-  Black/Amber Lens MA-021

**MANTIS** A favorite for years, offering a wide visible range. Fits *medium to wide* face shapes. Optical lenses available upon request.



-  Black/Clear Lens MA-010
-  Black/Amber Lens MA-011

**MANTIS 5** The same frame as our standard Mantis mask with a lower volume skirt offering 20 degrees more visibility. Fits *medium to wide* face shapes. Optical lenses available upon request.



-  Black/Clear Lens MA-040
-  Black/Amber Lens MA-041

**VISO** Low volume, fitting *narrow* face shapes. Shares the same lens shape as the Naida. Optical lenses available upon request.



-  Vortex Camo/Clear Lens MA-VX01

**RECON** The ideal entry level mask to start your underwater exploration. Durable frame and clear lens, featuring our Vortex Camo pattern.

#### GO PRO MASK MOUNT

Don't miss out on capturing that amazing diving moment. Whether catching a prize fish, or swimming with dolphins, our mask mounts are sure to make you a hero among your peers.



Mantis / Mantis 5 (MA-GP01)



#### MASK REPLACEMENT PARTS

1. Mask Strap MP-7007
2. Strap Retainer (2) MP-1231
3. Mask Buckles (2) MP-7010



## SNORKELS

### STABLE

A low profile light weight snorkel with a flexible Vinyl tube, giving divers ability to fold up or stow in their BC. The dry top is shaped like a shark fin and reduces catch of line, seaweed and floating material

The RIFFE Stable snorkel comes with a high quality hinged snorkel keeper. It is the easiest clearing snorkel tested in our industry by freedivers. This Amazing snorkel is a true Fresh Air Snorkel.

-  Caribbean Blue SN-020C
-  White SN-020W
-  Silver SN-020S
-  Black SN-020

### STANDARD J

Large barrel Standard J snorkel with rotating silicone mouthpiece

-  Black SN-030

### SCOUT

Simply a functional J style snorkel, featuring our Vortex Camo print. Yellow snorkel keeper.

-  Vortex Camo SN-040VX

### SNORKEL REPLACEMENT PARTS

1. Nylon Hinged Snorkel Keeper SP-7203
2. Stable Mouthpiece SP-7202 (regular) SP-7202S (small)
3. Standard J Mouthpiece SP-7201
4. Standard J Elbow SP-7209
5. Flexible Hose Stable SP-7214
6. Stable Body SP-7206
7. Stable Valve/Retainer SP-7204
8. Standard J Snorkel Keeper SP-7205



# RIFFE

*Adventure*

**The ocean is our refuge,  
a place to relax, soak in  
nature & reconnect with  
ourselves where we feel  
the most alive & happy.**

*Observe the beauty and mystery of the aquatic world in our Premium Mask & Snorkel Sets manufactured to our highest standards in Japan. Pair up with KICKS Rubber Swim Fins for an adventure collection unveiling new depths.*



## Premium MASK & SNORKEL Set



NEKTON Mask &  
STABLE Snorkel  
• Caribbean Blue  
MSK-090C



NEKTON Mask &  
STABLE Snorkel  
• White  
MSK-090W

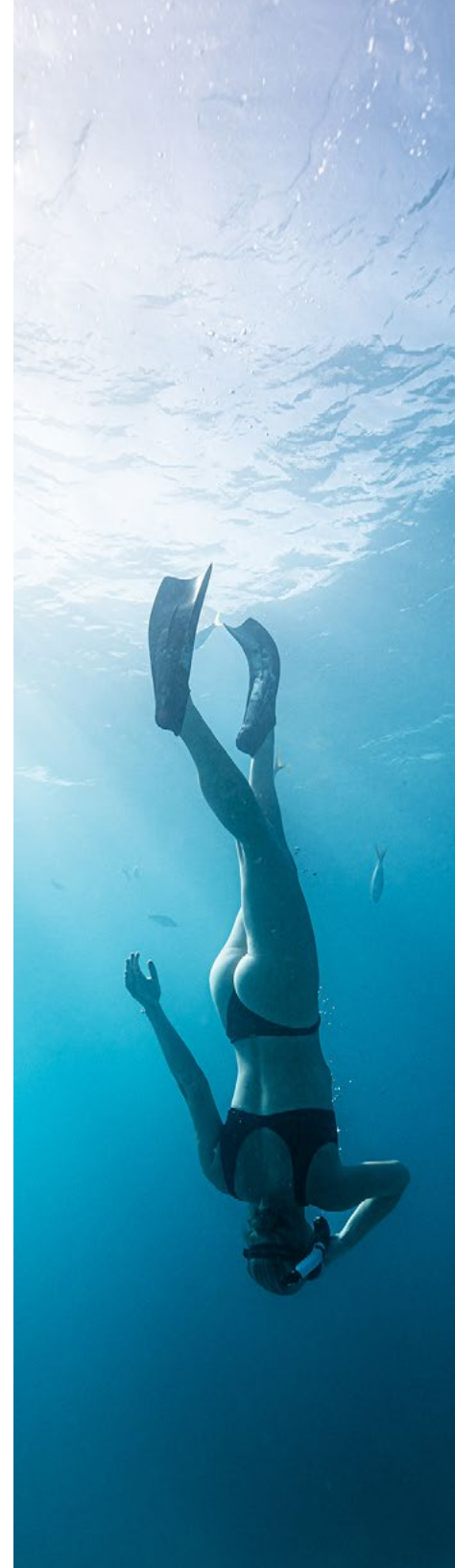

Premium  
**MASK &  
SNORKEL**  
Set



MANTIS Mask &  
STABLE Snorkel  
• Silver  
MSK-020S



FRAMELESS Mask &  
STABLE Snorkel  
• Black  
MSK-060B



**A NEW EARTH**

Recognizing the impact of plastics which end up on the ocean, RIFFE has partnered with A New Earth Project to develop a 100% curbside recyclable packaging solution for their Premium Masks and Snorkels.

***“Plastic clamshells are not an option for us. We are taking the necessary steps to eliminate single use plastics in our offerings.”***

*Jill Riffe Salerno CEO & daughter of founder Jay Riffe*



# KICKS

Rubber Swim Fins

The snorkeling and swimming fin of choice made from natural rubber and non-toxic raw materials and pigments. Our Kicks Rubber Swim Fins are produced responsibly with a strong emphasis on comfort. It's a win when hours fly by while exploring the underwater world with ease. Available in a range of six sizes means the whole family can enjoy using these swim fins. Let the adventure begin!

Features:

- Tabbed Heel – Take fins on & off with ease
- Contoured orthopedic foot pocket
- Flexible blade with excellent rebound
- Range of 6 sizes for the perfect fit

Sizing:

35/36 (3-4)	41/42 (9-10)
37/38 (5-6)	43/44 (10-11)
39/40 (7-8)	45/46 (12-13)



Storm Grey / Black  
FIN-GB\*\*\*\*

Caribbean Blue / Mint  
FIN-CM\*\*\*\*

Black / Caribbean Blue  
FIN-BC\*\*\*\*

## FINS

### DESCENDER PLASTIC FINS W/ VELOC FOOT POCKET

Offers an affordable choice for your daily dives. Developed to withstand the rigors of spearfishing in rough conditions and beyond. Polypropylene long blade design stores more energy to produce a strong thrust with minimal effort. Paired with RIFFE's Veloc Foot Pocket featuring a streamlined fit, made of Thermoplastic Rubber and a 20 degree angle for the optimum power stroke. Lightweight and comfortable. Available in a variety of sizes for the perfect fit.

### FIN KEEPERS

(FK-100, FK-105, FK-110)

- Helps secure foot when using oversized fins
- Eliminates noise
- Prevents energy loss and sores

Available Sizes: M, L, XL



### THE VELOC FOOT POCKET

Our newer streamlined fit, flexible Thermoplastic Rubber foot pocket. 20 degree angle. Lightweight and comfortable.

Sizes:

Mens	Women
* 36/37 (2-3)	6-7
* 38/39 (4-5)	7.5-8.5
* 40/41 (6-7)	9-9.5
* 42/43 (8-9)	10-10.5
* 44/45 (10-11)	12-13
* 46/47 (12-13)	





## FINS

### RIFFE BY DIVE R

RIFFE has collaborated with renowned top of the line fin blade manufacturer Dive R. Custom epoxy resin system and aerospace grade fabrics produce a fin that transfers load progressively from toe to heel. Carbon Fiber blades deliver optimum performance.

DIGI-TEK Carbon Fiber Fin Blade (only) / Medium Flex (FIN-DRC-DM)

- Also available in VORTEX Camo Pattern
- Available with VELOC Foot Pockets

\* Compatible with many foot pockets on the market.

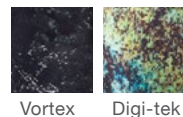

Vortex Digi-tek



## WEIGHT BELTS / FIN SOCKS / GLOVES

### MARSEILLE WEIGHT BELT

(WTB-2000BC Blue Camo, WTB-2000BK Black)

57" (145cm) Marseille style rubber weight belt for freediving and spearfishing offers a flexible belt that stays in place while diving. While on deeper dives as your waist compresses, this flexibility allows for a snug fit ensuring the weight belt doesn't slip up across your chest. Heavy duty stainless steel roller buckle makes releasing the belt in case of an emergency a cinch.



### RUBBER WEIGHT BELT

(WTB-1000 Black)  
(WTB-1015 Caribbean Blue)

54" (137cm) flexible rubber weight belt may be adjusted by cutting to size. Inner horizontal ribbing prevents shifting while diving. Anti-corrosive glass filled Nylon cam-lock buckle with fast ditch capability. Weight capacity 20 lbs.

**HEAVY DUTY S.S. WEIGHT RETAINERS** available.  
Weight belt with 4 retainers (WTB-1005)



GLOVE SIZE CHART	
HAND MEASUREMENT	GLOVE SIZE
7 / 17.75cm	XS
7.5in / 19cm	S
8in / 20.25cm	M
8.5in / 21cm	L
9in / 22.75cm	XL

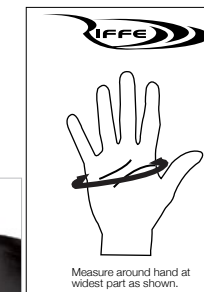

Measure around hand at widest part as shown.



### AMARA/NEOPRENE DIVING GLOVES

(GL-VX01, GL-DTA01, GL-CTA01, GL-BKA01)  
2mm Yamamoto Neoprene. Nylon bonded with our signature camo patterns (Vortex, Digi-tek) and black. Reinforced Amara palm and finger tips. A sensible choice for active hunters.  
Available Sizes: XS, S, M, L, XL



### HOLDFAST CUT RESISTANT GLOVES

(GL-CR01)  
Ideal for handling your spearfishing weapon of choice and keeping your hands safe from cuts and scrapes by lobster, fish gills, spines, and filet knives. Rated Level 5 Cut Resistant and Level 3 Puncture Resistant, ensures a day on and under the water unscathed. Palm and fingers are reinforced with crinkled latex for a holdfast non slip grip.  
Available Sizes XS, S, M, L, XL

### 2mm & 3.5mm 3-D FIN SOCKS W/ NON-SKID SOLE

BT-05 (2mm), BT-06 (3.5mm)

Double sided, Bonded Nylon. Smooth interior for comfort, ease of entry and exit from sock. Extra durable outer material for wear. Flexible slip resistant tread. Sold in pairs.

Available Sizes: S, M, L, XL, 2X  
(left and right foot specific)



Improved slip resistant tread



## WETSUITS

Slip into stealth mode with our Vortex wetsuit, the latest in RIFFE's distinguished digital camo collection. Dive deeper and stay longer in the Vortex.

RIFFE's world renowned Digi-tek camo pattern has proven to blend into most any ocean environment. Ideal in tropical and blue water.

Made from some of the best neoprene on the market, our wetsuits are incredibly comfortable, warm and flexible. 100% Chloroprene Neoprene is a limestone based rubber lending to a production process easier on the environment. Lightweight 4 way stretch fits like a second skin. Quick drying with excellent heat retaining properties, we promise once you've tried one on you won't want to take it off.

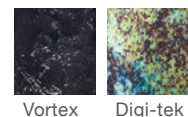

	2mm	3.5mm	5mm	7mm
Vortex	●	●	●	●
Digi-tek	●	●	●	●

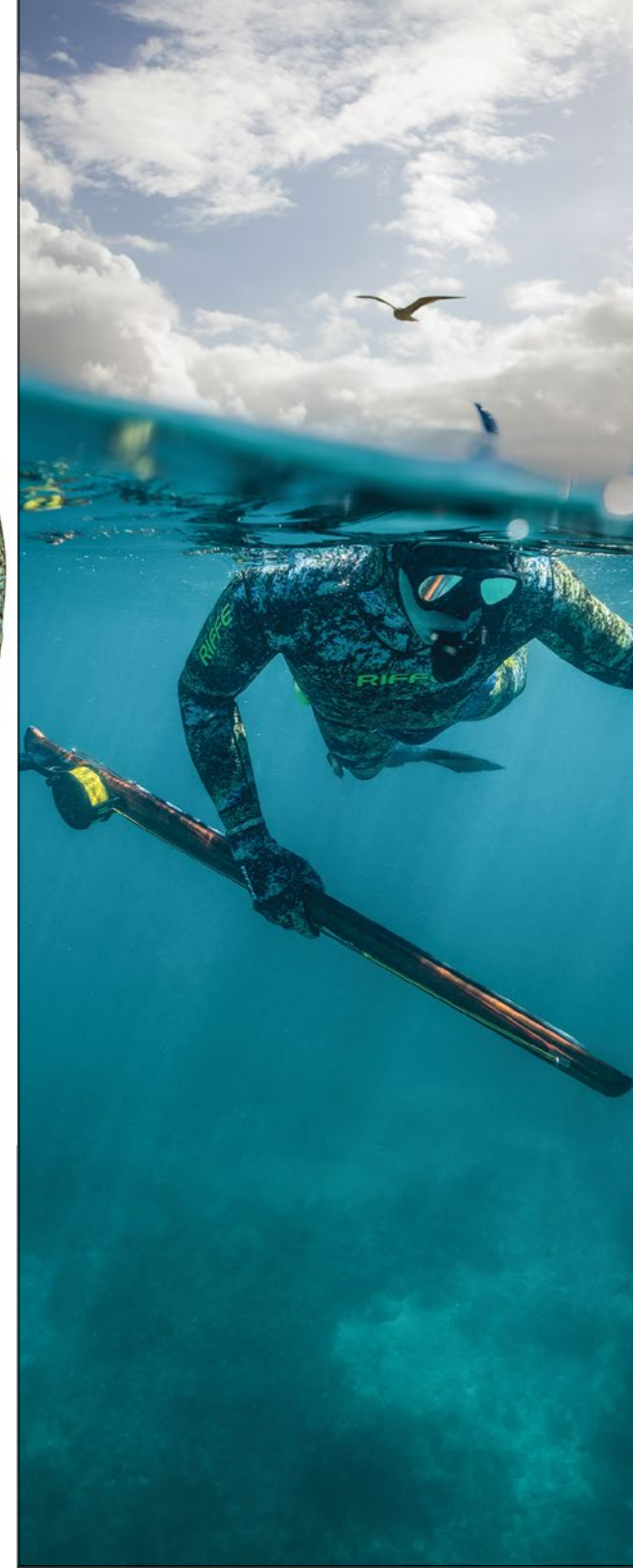

SIZE CHART			
US Size	Euro Size	Weight (lbs)	Height (feet/inch)
S	48	125-150	5'3"- 5'7"
M	50	135-165	5'4"- 5'10"
ML	52	165-180	5'6"- 5'11"
L	54	170-180	5'7"- 6'1"
XL	56	180-200	5'8"- 6'3"
XXL	58	190-205	5'9"- 6'5"
XXXL	60	200-225	5'11"- 6'5"

### VORTEX CAMO (3.5MM, 5MM & 7mm) (VWX3-, VWX5-, VWX7-)

#### FEATURES:

- Open cell Eco-friendly Yamamoto 39 Neoprene
- Glued & blind stitched seams
- Hooded Top with Twin Locking Clips at beavertail
- Abrasion resistant elbow protection
- High Waist Pant with abrasion resistant knee protection
- Smooth skin seals around face wrist and ankle
- Slip resistant, cushioned loading chest pad
- Vented hood promotes excess air release
- 3.5mm High Waist Pant
- 5mm & 7mm Farmer John
- 7mm Silver coated lining for extra heat retention
- Sizes S-3XL

### DIGI-TEK CAMO (2MM) (WTK2-)

#### FEATURES:

- Eco-friendly Yamamoto 39 Neoprene
- Nylon lined for durability
- Face, wrist and ankle seals to prevent water entry
- Non binding wrist/ankle seams for more flexibility
- Comfortable padded loading chest pad
- High density screenprint knee protection
- Vented hood promotes excess air release
- Flatlock stitching
- High Waist Pant
- Sizes S-3XL

### DIGI-TEK CAMO (3.5MM, 5MM) (WTK3-, WTK5-)

#### FEATURES:

- Open cell Eco-friendly Yamamoto 39 Neoprene
- Face, wrist and ankle seals to prevent water entry
- Non binding wrist/ankle seams for more flexibility
- High density screenprint/cushioned chest pad
- High density screenprint knee protection
- Vented hood promotes excess air release
- 3.5mm High Waist Pant
- 5mm Farmer John
- Sizes S-3XL

## WETSUITS

### WOMENS DIGI-TEK CAMO WETSUIT (3.5MM) (WLTk3) & (5MM) (WLTk5)

RIFFE's signature DIGI-TEK® digital camo adorns a form fitting cut designed specifically to address the needs of women divers. Constructed from the same high quality Yamamoto Neoprene and materials RIFFE is known for, the Women's Digi-tek® 2 pc wetsuit has you covered in all the right places.

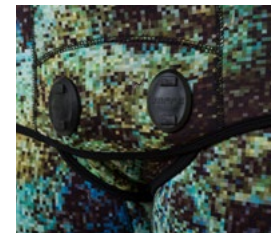
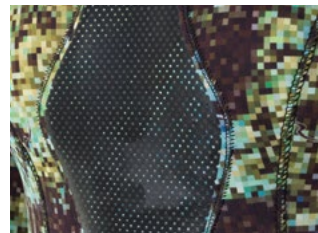

#### FEATURES:

- Open cell Eco-friendly Yamamoto 39 Neoprene
- Glued & blind stitched seams
- Form fitting women's cut, lightweight & ultraflexible
- Excellent heat retention, quick drying
- Face, wrist and ankle seals to prevent water entry
- Slip resistant cushioned chest pad
- Abrasion resistant high density Polyurethane screened knee and elbow protection.
- Vented hood promotes excess air release
- Hooded Top + High Waist Pant
- Sizes XS-L

US Size	Weight (lbs)	Height (feet/inch)
XS	100 - 110	4'8" - 5'4"
S	110 - 130	5'0" - 5'4"
M	125 - 150	5'3" - 5'7"
L	135 - 160	5'6" - 5'8"

Taylor is wearing a swimwear top (not included) with High Waist Pant





## WETSUITS & LYCRA

### SYREN WOMEN'S 2MM LONG SLEEVE SPRING WETSUIT (WLTK2)

Heed the call, enter the underwater realm keeping the chill and sun exposure to a minimum with the Syren Long Sleeve Spring Wetsuit. Riffe's signature Digi-tek Camo print compliments a second skin silhouette and stays secure in all the right places.

A half zip at center front allows for heat control. Premium 2mm lightweight neoprene foam manufactured from recycled materials plus 100% recycled Ultraflex jersey keeps the sustainability and flexibility factor high. Seams are finished with non-toxic water based adhesive and stitch construction.

#### FEATURES:

- Eco-Conscious Fabric: 85% Recycled Polyester 15% Spandex
- Neoprene: Lightweight recycled foam made from upcycled car tires and neoprene scraps
- High thermal retention and stretch
- Flatlock Stitch seams with non toxic water based adhesive
- Front zip entry
- Sizes XS-L

Size	Weight (lbs.)	Height (feet' Inch")
XS	110-125	5'0"- 5'4"
S	125-135	5'3"- 5'6"
M	135-160	5'4"- 5'8"
L	150-170	5'5"- 5'10"



Model is 5'5", 125 lbs wearing a size Small

### ECO HOODED LONG SLEEVE RASH GUARD WITH LOADING PAD (RG-DT)

Keeps you covered during long days in the sun and water. Made from recycled materials featuring UPF 50 protection and cushioned chest pad for speargun loading.

#### FEATURES:

- UPF50
- Flatlock Stitch
- Cushioned Chest Pad
- 85% Recycled Polyester 15% Spandex
- Sizes S-3XL



Model is 5'10", 155 lbs wearing a size Medium

## BAGS

**SLINGER** Pole Spear Case



**FEATURES:**

- Heavy duty elastic webbing secures pole spear sections in place
- Internal reinforced sheath keeps pole spear end/tips protected
- 25" Internal flap pocket holds tips/tools
- Durable 600D polyester fabric with Vortex© Camo print
- Tough clear water resistant TPE-film laminate stands up to harsh environments
- Weather resistant & Abrasion resistant
- Padded body
- Removable shoulder strap with Duraflex D-rings and clips
- Large #10 corrosion resistant waterproof nylon zipper
- Double zipper pulls adds locking functionality
- Opens to lay flat

Dimensions 42" x 5" x 2.25" (106.7cm x 12.7cm x 5.7cm)  
1.7 lb (771g)

Vortex Camo  
(BG-2027VX)

**STASH** Fin Gear Bag



**FEATURES:**

- Large main compartment with mesh panels for ventilation
- Zippered exterior pocket 16" x 8" x 3" (40.6cm x 20.3cm x 7.6cm)
- Durable 600D polyester fabric with Vortex© Camo print
- Tough clear water resistant TPE-film laminate stands up to harsh environments
- Weather resistant & Abrasion resistant
- Padded removable shoulder strap with Duraflex D-rings and clips
- Large #10 corrosion resistant waterproof nylon zipper
- Double zipper pulls adds locking functionality

Dimensions 41" x 11" x 6" (104cm x 28cm x 15.25cm)  
2.2 lb. (998g)

Vortex Camo  
(BG-2040VX)

## ACCESSORIES

**LOBSTROSITY** Lobster Gauge (California) 3.25"



**ADVENTURE COLLECTION RETAIL DISPLAY**  
Minimum Purchase Required

Accommodates 27 Premium Mask/Snorkel Kits & 24 Kicks Rubber Fin Sets



## HATS



**LINEUP**  
HT-001LUP

6 Panel Retro Mesh Trucker | Polyester/Cotton  
Snapback | Woven Patch w/ Merrow edge  
MutliCam Black



**FUTURE FISH**  
HT-001FUF

5 Panel Classic Trucker | Polyester/Cotton  
Snapback | Woven Patch w/ Merrow edge  
Sage



**HARVEST**  
HT-HVT01

5 Panel Premium Trucker | Acrylic/Wool  
Snapback | Woven Patch w/ Merrow edge  
Moss



**WAHOO**  
HT-WAH01

5 Panel Premium Trucker | Acrylic/Wool  
Snapback | Woven Patch w/ Merrow edge  
Black



**QUEST MULTICAM**  
HT-QST02

5 Panel Classic Trucker | Polyester/Cotton  
Snapback | Woven Patch w/ Merrow edge  
MultiCam Black

**APPAREL**



**EAST COAST DIVE**  
MT-ECD01  
100% Cotton | Cream  
S-2X



**HARVEST**  
MT-HVT01  
100% Cotton | Sand  
S-2X



**WEST COAST DIVE**  
MT-YDR01  
100% Cotton | Charcoal  
S-2X



**SPEARVOLVE**  
MT-SVM01  
100% Cotton | Navy  
S-2X



**YESTER**  
MT-YST01

100% Cotton | Sand  
S-2X



**GUNNER**  
MT-GNR02

100% Cotton | White  
S-2X

**GUNNER**  
MT-GNR03

100% Cotton | Black  
S-2X

**GUNNER**  
MT-GNR04

Poly/Cotton Blend | Maroon Heather  
S-2X



**FIRECAMP**  
MT-FCM01

100% Cotton | Black  
S-2X



**WOMEN'S HARVEST**  
WT-HVT01

100% Cotton | Navy  
S-2X



**RIFFE INTERNATIONAL INC.**

1214 Puerta Del Sol  
San Clemente, CA 92673 USA  
tel: (949) 361 2818  
toll free: (800) 773 2748  
info@speargun.com  
www.riffeinternational.com

Photo Credit:  
Justin Turkowski  
DJ Struntz  
Kenny Hekhuis  
Mike Raabe