

**GET READY
TO SMOKE
LIKE A PRO.**



**SAWDUST-FUELED
MODEL SG350
SMOKE GENERATOR**

SAWDUST-FUELED MODEL SG350 SMOKE GENERATOR

Our state-of-the-art sawdust generators feature automatic or manual settings. Versatile design offers the ability for sawdust or liquid smoke. Stainless steel 16 gauge piping between smoker oven and smoke producer makes for a clean and durable transfer.

Features

- Heavy Duty 12 Gauge Stainless Steel Construction
- Sawdust Smoke Producer

Specs

- Burn Box: H 22" x W 20" x D 20"
- 16 Gauge, Stainless Steel Piping Between Generator & Smoker Oven
- Auto or Manual Controls

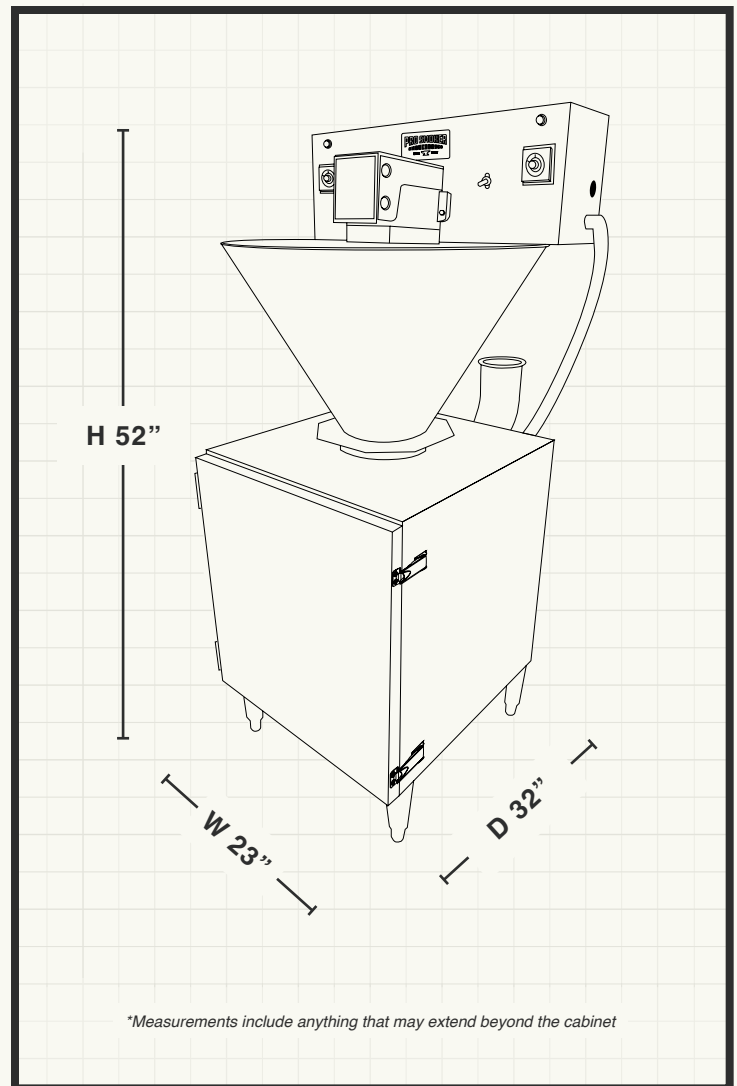

FEATURES



Durable Design



Made in USA

Warranty

Pro Smoker 'N Roaster® has one of the best in the industry: One year limited warranty on parts, 90 days on electrical components.