



The endless work lights...

# LED WORK LIGHTS

## Lasts Forever!

Village Kherki Daula, National Highway-8  
Gurgaon-122001, Haryana, INDIA  
TEL +91.124.282.7700 / 221.4050  
FAX +91.124.2827986 / 2214224  
FAX(USA) +1.509.271.7848  
FAX(UK) +44.870.121.1854  
E-MAIL [info@groz-tools.com](mailto:info@groz-tools.com)  
URL [www.groz-tools.com](http://www.groz-tools.com)

Whilst every effort has been made to ensure accuracy of information given in this catalogue at the time of going to print, Feb 2016, our policy of continuous improvement determines the right to change specifications without notice. Customers must ensure that goods are suitable for the purpose intended.

GL -03

**01**

**LED 15W  
Floodlight**

**LED-501**

**LED-502**



15W floodlight with aluminium die cast housing in premium powder coated finish & stainless steel bracket

Powerful 5 LED's of 3W each with a light output of 900 lumens

**Power Source:**  
12V DC - 36V DC

**Current Draw:** 1.0 amp at 12V & 0.50 amp at 24V

**Square Construction:**  
3-11/32" (85 mm) x 3-11/32" (85 mm) x 1-3/8" (35 mm)

**Water & Dust Proof Rating:**  
IP67 (Dust tight & protected against effects of water immersion up to 1 metre)

Comes complete with 20' (500 mm) DC power cord



Ideal for outdoor use on construction equipment, tractors, farm machinery, service vans, emergency vehicles etc.

Available as single or set of two



**LED/501**

**FEATURES**

LUMEN	POWER SOURCE
 900	 12V DC - 36V DC
WATER & DUST PROOF RATING	OPERATING TEMPERATURE
IP67	-20°C TO 45°C (-4°F TO 113°F)



**ORDERING INFORMATION**

CAT NR.	ORD NR.	DESCRIPTION
LED/501	55016	Single Piece
LED/502	55026	Set of Two

15W floodlight with aluminium die cast housing in premium powder coated finish & stainless steel bracket

Tight rubber sealing prevents ingress of dust and moisture

Powerful 5 LED's of 3W each with a light output of 1050 lumens

**Power Source:**  
12V DC - 60V DC

**Current Draw:** 1.5 amp at 12V & 0.5 amp at 60V

**Rectangular Construction:**  
4" (101 mm) wide x 4-13/6" (122 mm) high x 1-7/8" (48 mm) deep

Comes complete with 20" (500 mm) DC power cord



**Water & Dust Proof Rating:**  
IP67 (Dust tight & protected against effects of water immersion up to 1 metre)

Ideal for outdoor use on construction equipment, tractors, farm machinery, service vans, emergency vehicles etc.

**NEW!**



**FEATURES**

LUMEN	POWER SOURCE
 1050	 12V DC - 60V DC
WATER & DUST PROOF RATING	OPERATING TEMPERATURE
IP67	-20°C TO 45°C (-4°F TO 113°F)



**ORDERING INFORMATION**

CAT NR.	ORD NR.
LED/520	55027

18W floodlight with aluminium die cast housing in premium powder coated finish & stainless steel bracket

Tight rubber sealing prevents ingress of dust and moisture

270° rotation

Powerful 6 LED's of 3W each with a light output of 1200 lumens

**Power Source:**  
12V DC - 60V DC

**Current Draw:** 2.0 amp at 12V & 0.50 amp at 60V

**Rectangular Construction:**  
4-9/32" (109 mm) wide x 5" (127 mm) high x 1-21/32" (42 mm) deep

Comes complete with 20' (500 mm) DC power cord



**Water & Dust Proof Rating:**  
IP67 (Dust tight & protected against effects of water immersion up to 1 metre)

Ideal for outdoor use on construction equipment, tractors, farm machinery, service vans, emergency vehicles etc.

**NEW!**



**FEATURES**

LUMEN	POWER SOURCE
 1200	 12V DC - 60V DC
WATER & DUST PROOF RATING	OPERATING TEMPERATURE
IP67	-20°C TO 45°C (-4°F TO 113°F)

**ORDERING INFORMATION**

CAT NR.	ORD NR.
LED/530	55028

27W floodlight with aluminium die cast housing in premium powder coated finish & stainless steel bracket

Powerful 9 LED's of 3W each with a light output of 1600 lumens

**Power Source:**  
12V DC - 36V DC

**Current Draw:** 1.8 amp at 12V & 0.6 amp at 36V

**Square Construction:**  
4-9/16" (116 mm) wide x 4-1/4" (108 mm) high x 2-15/32" (63 mm) deep



Comes complete with 20' (500 mm) DC power cord

**Water & Dust Proof rating:**  
IP68 (Dust tight & protected against effects of water immersion under pressure)

Ideal for outdoor use on construction equipment, tractors, farm machinery, service vans, emergency vehicles etc.



### FEATURES

LUMEN	POWER SOURCE
 1600	 12V DC - 36V DC
WATER & DUST PROOF RATING	OPERATING TEMPERATURE
IP68	-20°C TO 45°C (-4°F TO 113°F)



### ORDERING INFORMATION

CAT NR.	ORD NR.
LED/511	55017

45W floodlight with aluminium die cast housing in premium powder coated finish & stainless steel bracket

Powerful 15 LED's of 3W each with a light output of 2300 lumens

**Power Source:**  
12V DC - 36V DC

**Current Draw:** 4 amp at 12V & 1.5 amp at 36V

**Rectangular Construction:**  
6-7/32" (158 mm) wide x 3-13/16" (97 mm) high x 3-3/32" (79 mm) deep

Comes complete with 20" (500 mm) DC power cord



**Water & Dust Proof Rating:**  
IP65 (Dust Tight & protected from low pressure jets from any directions)

Ideal for outdoor use on construction equipment, tractors, farm machinery, service vans, emergency vehicles etc.

**NEW!**



**FEATURES**

LUMEN	POWER SOURCE
 2300	 12V DC - 36V DC
WATER & DUST PROOF RATING	OPERATING TEMPERATURE
IP65	-20°C TO 45°C (-4°F TO 113°F)



**ORDERING INFORMATION**

CAT NR.	ORD NR.
LED/540	55029

**06**

**LED 36W  
Light Bar**

**LED-700**

36W Light bar with Aluminium extruded housing in premium powder coated finish

Powerful 12 LED's of 3W each with a light output of 2200 lumens

**Power Source:** 12V DC - 60V DC

**Current Draw:** 3.5 amp at 12V & 1 amp at 60V

**Rectangular Construction:**  
8-1/4" (210 mm) wide x 4-17/32" (115 mm) high x 3-11/32" (85 mm) deep

Comes complete with 20" (500 mm) DC power cord

**Water & Dust Proof Rating:** IP67 (Dust tight & protected against effects of water immersion up to 1 metre)

Ideal for use on roof top of ATV's, UTV's, trucks & SUV's



**NEW!**



**ORDERING INFORMATION**

CAT NR.	ORD NR.
LED/700	55030

**FEATURES**

LUMEN	POWER SOURCE	WATER & DUST PROOF RATING	OPERATING TEMPERATURE
 2200	 12V DC - 60V DC	IP67	-20°C TO 45°C (-4°F TO 113°F)

**07**

**LED 72W  
Light Bar**

**LED-710**

72W Light bar with Aluminium extruded housing in premium powder coated finish

Powerful 24 LED's of 3W each with a light output of 4300 lumens

**Power Source:** 12V DC - 60V DC

**Current Draw:** 7 amp at 12V & 1.5 amp at 60V

**Rectangular Construction:**  
14" (355 mm) wide x 4-11/32" (115 mm) high x 3-11/32" (85 mm) deep

Comes complete with 20" (500 mm) DC power cord

**Water & Dust Proof Rating:** IP67 (Dust Tight & Protected against effects of water immersion up to 1 metre)

Ideal for automotive & mining applications. Used on ATV's, UTV's, trucks, SUV, dumpers, loaders, excavators etc.



**NEW!**



**ORDERING INFORMATION**

CAT NR.	ORD NR.
LED/710	55031

**FEATURES**

LUMEN	POWER SOURCE	WATER & DUST PROOF RATING	OPERATING TEMPERATURE
 4300	 12V DC - 60V DC	IP67	-20°C TO 45°C (-4°F TO 113°F)

**NEW!**

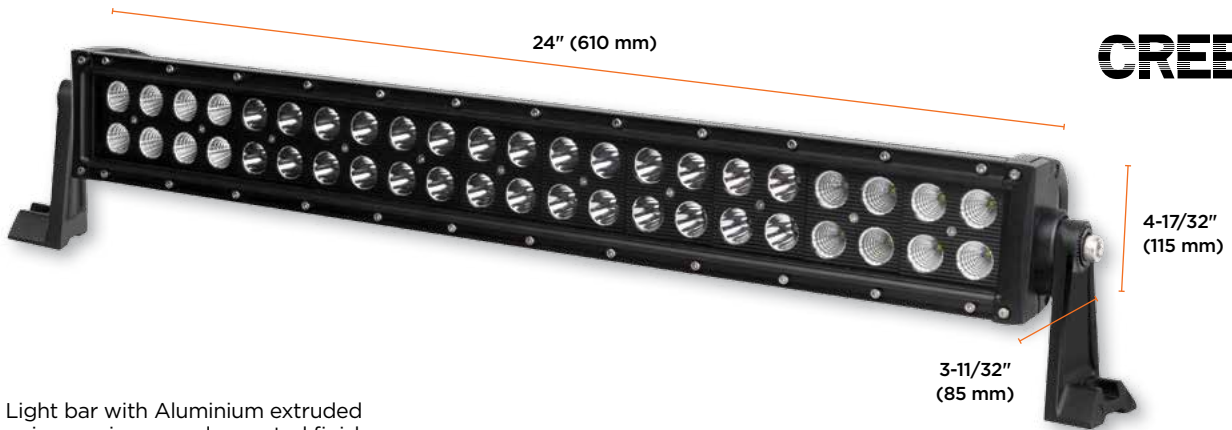

132W Light bar with Aluminium extruded housing in premium powder coated finish

Powerful 44 LED's of 3W each with a light output of 6500 lumens

**Power Source:**  
12V DC - 60V DC

**Current Draw:** 12 amp at 12V & 3 amp at 60V

**Rectangular Construction:**  
24" (610 mm) wide x 4-17/32" (115 mm) high x 3-11/32" (85 mm) deep

Comes complete with 20" (500 mm) DC power cord

**Water & Dust Proof Rating:**  
IP67 (Dust tight & protected against effects of water immersion up to 1 metre)



Ideal for use in mining application on trucks, dumpers, loader, excavators etc.



**ORDERING INFORMATION**

CAT NR.	ORD NR.
LED/720	55032

**FEATURES**

LUMEN	POWER SOURCE	WATER & DUST PROOF RATING	OPERATING TEMPERATURE
 6500	 12V DC - 60V DC	IP67	-20°C TO 45°C (-4°F TO 113°F)



09

## LED 27W Site Lamp

LED-601

27W Site lamp with aluminium die cast housing in premium powder coated finish

Portable powder coated free-standing steel stand with cushion grip & adjustable stainless steel bracket

Powerful 9 LED's of 3W each with a light output of 1600 lumens

Keeps work place cool as lights don't disperse heat

**Power Source:**  
220V AC, 50 Hz. & 110V AC, 60 Hz.

Complete with 4m long power cord

**Water & Dust Proof Rating:** IP68 (Dust tight & protected against effects of water immersion under pressure)



Ideal for portable working in maintenance, building construction, temporary lighting jobs etc.



### ORDERING INFORMATION

CAT NR.	ORD NR.
LED/601	55018

### FEATURES

LUMEN	POWER SOURCE	WATER & DUST PROOF RATING	OPERATING TEMPERATURE
 1600	 110V AC 220V AC	IP68	-20°C TO 45°C (-4°F TO 113°F)

10

## LED 54W Site Lamp

LED-611

54W Site lamp with aluminium die cast housing in premium powder coated finish

Portable powder coated tripod stand with separate adjustments for base, height (up to 1.5m) & each individual light

Powerful 9 LED's of 3W each in each housing with a total light output of 3200 lumens

Keeps work place cool as lights don't disperse heat

**Power Source:** 220V AC, 50 Hz. & 110V AC, 60 Hz.

Complete with 4m long power cord

**Water & Dust Proof Rating:** IP68 (Dust tight & protected against effects of water immersion pressure)



Ideal for portable working in maintenance, building construction, temporary lighting jobs etc.



### ORDERING INFORMATION

CAT NR.	ORD NR.
LED/611	55019

### FEATURES

LUMEN	POWER SOURCE	WATER & DUST PROOF RATING	OPERATING TEMPERATURE
 3200	 110V AC 220V AC	IP68	-20°C TO 45°C (-4°F TO 113°F)

11

## LED 15W Portable Lamp with Magnetic Base

LED-630

15W portable lamp with aluminium die cast housing in premium powder coated finish

Portable free standing base with powerful base magnet attaches conveniently to any metallic surface such as a vehicle etc.

5 LED's of 3W each with a light output of 900 lumens

**Power Source:**  
12V DC - 36V DC

**Current Draw:** 1 amp at 12V & 0.5 amp at 36V

Complete with cigarette plug adaptor

**Water & Dust Proof Rating:**  
IP67 (Dust tight & protected against effects of water immersion up to 1 metre)

**Wire Length:** 4 metres

Ideal portable worklight for automobiles



**NEW!**



### FEATURES

LUMEN	POWER SOURCE	WATER & DUST PROOF RATING	OPERATING TEMPERATURE
900	12V DC - 36V DC	IP67	-20°C TO 45°C (-4°F TO 113°F)

### ORDERING INFORMATION

CAT NR.	ORD NR.
LED/630	55034

12

## LED 15W Rechargeable Site Lamp

LED-620

15W Rechargeable site lamp with aluminium die cast housing in premium powder coated finish

Portable free standing heavy base with powerful base magnet

32.6WH Rechargeable Lithium Ion Battery

Complete with dual voltage AC power adaptor and an additional 12/24 V DC adaptor

**Power Source:** 220V AC, 50 Hz. & 110V AC, 60 Hz.

**Run Time:** 4 hours with a single full charge

**Charge Time:** 7.5 hours

Keeps work place cool as lights don't dispense heat

**Wire Length:** 1.2 metres

**Water & Dust Proof Rating:** IP65 (Dust tight & protected against low pressure water jets)

Ideal for portable working in maintenance, building construction, temporary lighting jobs etc.



### FEATURES

LUMEN	POWER SOURCE	WATER & DUST PROOF RATING	RUN TIME	OPERATING TEMPERATURE
900	110V / 220V AC 12V / 24V DC	IP65	4 H	-10°C TO 45°C (14°F TO 113°F)

### ORDERING INFORMATION

CAT NR.	ORD NR.
LED/620	55022

**NEW!**

9W Rechargeable site lamp with aluminium die cast housing in premium powder coated finish

Portable LED lights with free standing heavy base

3.7V (6600 mAh), 24.42 WH Rechargeable Lithium Ion Battery

270° rotation

Complete with USB charging cable compatible with phone charger adaptor

**Run Time:** 4 hours with a single full charge

**Charge Time:** 8-10 hours

**Dual Colour Lamp:**  
Amber/White



Comes complete with 24" (600 mm) DC power cord

**Water & Dust Proof Rating:**  
IP65 (Dust Tight & protected from low pressure jets from any directions)

Ideal for portable working in maintenance, building construction, temporary lighting jobs etc.



**FEATURES**

<b>LUMEN</b>	<b>POWER SOURCE</b>
 500	 5V DC
<b>WATER &amp; DUST PROOF RATING</b>	<b>RUN TIME</b>
IP65	 4 H
<b>OPERATING TEMPERATURE</b>	
-10°C TO 45°C (14°F TO 113°F)	



Charge your lamp using laptop

**ORDERING INFORMATION**

<b>CAT NR.</b>	<b>ORD NR.</b>
LED/640	55035

**NEW!**

9W Site lamp with aluminium die cast housing in premium powder coated finish'

Portable LED lights with free standing magnetic base

3.7V (6600 mAH), 24.42 WH Rechargeable Lithium Ion Battery

270° rotation

Comes complete with USB charging cable compatible with phone charger adaptor

**Run Time:** 4 hours with a single full charge

**Charge Time:** 8-10 hours

**Dual Colour Lamp:** Amber/White



Comes complete with 24" (600 mm) DC power cord

**Water & Dust Proof Rating:** IP65 (Dust Tight & protected from low pressure jets from any directions)

Ideal for portable working in maintenance, building construction, temporary lighting jobs etc.



**FEATURES**

LUMEN	POWER SOURCE
 500	 5V DC
OPERATING TEMPERATURE	
-10°C TO 45°C (14°F TO 113°F)	
WATER & DUST PROOF RATING	RUN TIME
IP65	 4 H



Charge your lamp using laptop

**ORDERING INFORMATION**

CAT NR.	ORD NR.
LED/650	55036

# 15 LED 60 SMD Rechargeable Work Light

LED-340

Rugged, **unbreakable** construction with light weight yet strong aluminium tubing & TPR handle

60 SMD produce a super bright work light (350 lumens)

Includes two rotating hooks with ratchet movement & an additional hook with magnet that attaches to any metallic surface for hands free use

Dual Voltage AC charger for use with 220V AC, 50 Hz & 110V AC, 60 Hz

Rechargeable 3.7V, 4000 mAh Lithium Ion Battery

**Charge Time:** 4 hours  
**Water & Dust Proof Rating:** IP42  
**Use time with a single full charge:** Up to 5 hours  
 Ideal for use in machinery repair, testing, automotive jobs etc.

**FEATURES**

LUMEN	POWER SOURCE
 350	 110V AC 220V AC
RUN TIME	WATER & DUST PROOF RATING
 5 H	IP42

**ORDERING INFORMATION**

CAT NR.	ORD NR.
LED/340	55024



# 16 LED 200 SMD Rechargeable Underhood Work Light

LED-350

Underhood Worklight with Aluminium Tubing & TPR handle

200 SMD produce a super bright work light (1000 lumens)

Includes 2 retractable & rotating cushion grip clamps which allow the light to be fitted in any direction on hoods of light, medium & heavy automobiles

Retraction allows the light to expand from 47" (1194 mm) wide to 76" (1930 mm) wide

Dual voltage AC charger for use with 220V AC, 50 Hz. & 110V AC, 60 Hz.

Rechargeable 3.7V, 8000 mAh Lithium Ion Battery

**Water & Dust Proof Rating:** IP42  
**Charge Time:** 4.5 Hours  
**Use Time with a single full charge:** Up to 2.45 Hours  
 Ideal for use on automobiles, construction sites, repair work etc.

**FEATURES**

LUMEN	POWER SOURCE
 1000	 110V AC 220V AC
RUN TIME	WATER & DUST PROOF RATING
 2.45 H	IP42

**ORDERING INFORMATION**

CAT NR.	ORD NR.
LED/350	55025

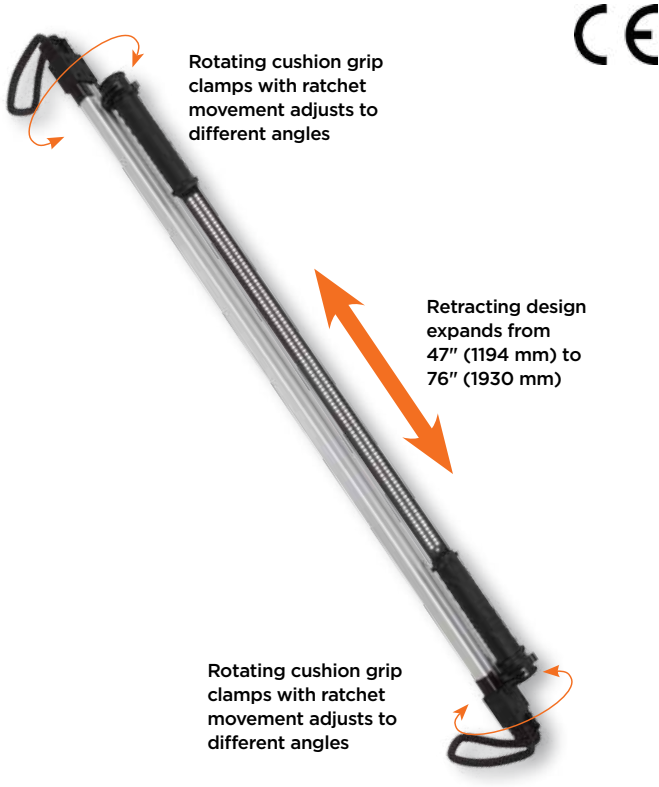

High quality aluminium work light in anodized finish

**Multiple Usage:** Can be used as a work light, flashlight or emergency light

18 super Bright LED's on the side produce very bright light (28 lumens) for use in machinery repair, tool setting, automotive jobs etc.

Additional 7 LED's on the top for use as a flashlight (18 lumens)

6 Red LED's on the side flash for signalling Emergency

Magnet built into the base allows the light to attach to any metallic surface for hands free use

Additional hang rope for ease of installation

**Water Proof Rating:** IPX4 (Protection against splashing water)

Ready to use, supplied complete with 3 AAA Batteries



7 LED's on top for use as Flashlight



Magnetic attachment for hands free use



**FEATURES**

LUMEN	BATTERY INCLUDES	WATER PROOF RATING
 28	<b>3</b> AAA	IP X 4



**ORDERING INFORMATION**

CAT NR.	ORD NR.
LED/301	55020

# 18

## LED Dry Cell Inspection Lamp

LED-320

Inspection Lamp with impact resistant rubberized casing

24 Super bright LED's produce a very bright light (48 lumens)

Magnet built into the back allows the light to attach to any metallic surface for hands free use

Additional 360° swivel hook for ease of installation

For use in machinery repair, tool setting, automotive jobs etc.

Ready to use, supplied complete with 3 AA batteries

### FEATURES

LUMEN	BATTERY INCLUDES
48	3 AA

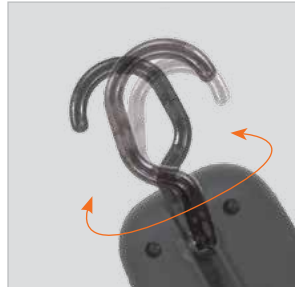

Swivel hook adjusts to different angles



Strong magnet attaches to most metal surfaces



### ORDERING INFORMATION

CAT NR.	ORD NR.
LED/320	55008

# 19

## Pocket LED Mini Work Light

LED-330

**High Quality Pen Light:**  
ABS body with rubberised housing for comfortable grip

Compact durable, and fits right into your pocket

Great for use in confined areas such as engine bays, and to look into cavities and pipes under the hood or under the vehicle

7 Bright LED's produce a very bright work light (36 lumens)



Magnet built into the back allows the light to attach to any metallic surface for hands free usage

Moulded clip on back. Clip swivels allowing versatile options to attach to belt or in the shirt pocket

Ideal for use in shop, garage, automotive jobs, emergency repair on the road etc.

Ready to use, supplied complete with 3 AAA batteries that last upto 11 hours of continuous use

### FEATURES

LUMEN	RUN TIME
 36	 11 H
BATTERY INCLUDES	
3 AAA	

### ORDERING INFORMATION

CAT NR.	ORD NR.
LED/330	55014



# 20

## LED 3W Rechargeable Spotlight

LED-401

Super bright LED spot light with extra power CREE 3W LED (270 lumens)

Impact resistant rubberised ABS body with self locking switch

**Beam Distance:** 500 metres

Includes dual voltage AC charger for use with 220V AC, 50 Hz. and 110V AC 60 Hz. Also includes an additional 12V DC Car Charger

Rechargeable 3.7V 2000 mAh Lithium Ion Battery





**Water & Dust Proof Rating:** IP20

**Charge Time:** 8 hours

**Use Time with a single full charge:** Up to 2 hours

Ideal for vehicle breakdowns, under the hood & under the vehicle inspection, security etc.

### FEATURES

LUMEN	POWER SOURCE
 270	 110V AC 220V AC
RUN TIME	BEAM DISTANCE
 2 H	 500 M
WATER & DUST PROOF RATING	
IP20	

### ORDERING INFORMATION

CAT NR.	ORD NR.
LED/401	55023

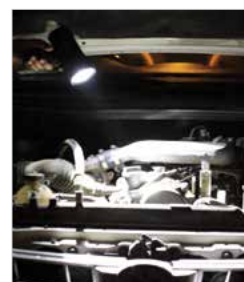



Super bright LED head light with extra power CREE Q5 3W LED (120 lumens)



ABS body with machined aluminium lens holder

Built In Zoom feature with magnification from 1X to 2000X

**Beam Distance:** 120 meters

Adjustable head positioning with foam pad to prevent chafing to the forehead





3 Modes: Low, High & Flash

Ideal for hands free work in automotive, plant maintenance, construction sites, mining etc.

Ready to use, supplied complete with 3 AAA batteries that last up to 5 hours of continuous use



**FEATURES**

LUMEN	BEAM DISTANCE	ZOOM
 120	 120 M	 1X TO 2000X
RUN TIME	BATTERY INCLUDES	
 5 H	 3 AAA	



**ORDERING INFORMATION**

CAT NR.	ORD NR.
LED-200	55004

22

## LED 3W Professional Head Light (With Built in Hand Sensor)

LED-205

Super bright LED head light with extra power CREE X PE 3W LED (120 lumens)

Option to switch On/Off through hand sensor

ABS body

Built In Zoom feature

**Beam Distance:** 100 metres

3 Modes: 3W LED On, 5 mm LED On, & 5 mm LED Flash

Ideal for hands free work in automotive, plant maintenance, construction sites, mining etc.



Ready to use, supplied complete with 3 AAA batteries that last up to 6 hours of continuous use

### ORDERING INFORMATION

CAT NR.	ORD NR.
LED/205	55021



### FEATURES

LUMEN	BEAM DISTANCE	RUN TIME	BATTERY INCLUDES
 120	 100 M	 6 H	<b>3</b> AAA

23

## LED Head Light

LED-210

Bright LED head light with 8 White LED's (12 lumens) & 1 Red flashing LED

ABS body with rubberized lens holder

Adjustable head positioning with foam pad to prevent chafing to the forehead

**Beam Distance:** 10 metres

3 Modes: 8 White LED, 1 Red LED, 1 Red Flashing LED

Ideal for hands free work in automotive, plant maintenance, construction sites, mining etc.



Ready to use, supplied complete with 1 AA battery that lasts up to 7 hours of continuous use

### ORDERING INFORMATION

CAT NR.	ORD NR.
LED/210	55005



### FEATURES

LUMEN	BEAM DISTANCE	RUN TIME	BATTERY INCLUDES
 12	 10 M	 7 H	<b>1</b> AA

24

## LED Flashlight with Telescopic Magnetic Pick Up

LED-130

Machined high quality aluminium flashlight that doubles as a magnetic pick-up tool

Unique flexible telescopic design that extends from 6-11/16" (17 cm) to 21-21/32" (55 cm)

3 LED's in the front with an 8 lumen rating helps to reach out in dark areas

Magnet built into the front end allows for easy pick-up of light metallic parts

Ideal for picking up metallic objects in hard to reach & dark places

Ready to use, supplied complete with 4 x 1.5 LR44 batteries

Includes pocket clip



Built-in magnet for easy picking up of light metallic parts

### FEATURES

LUMEN	BATTERY INCLUDES
8	4 1.5 LR44

### ORDERING INFORMATION

CAT NR.	ORD NR.
LED/130	55003

25

## LED Flashlight

LED-100

High quality aluminium flashlight with laser pointer

2 Modes: 8 white LED flashlights with an 18 lumen rating & 1 red laser pointer

**Beam Distance:** 20 metres

Ideal tool box accessory for maintenance professionals, mechanics, drivers, supervisors etc.

Supplied complete with 3 AAA batteries that last upto 5.5 hours of continuous use



### FEATURES

LUMEN	BEAM DISTANCE	RUN TIME	BATTERY INCLUDES
18	20 M	5.5 H	3 AAA

### ORDERING INFORMATION

CAT NR.	ORD NR.
LED-100	55000

**26**

## LED UV Inspection Light

LED-120

Machined high quality aluminium 9 LED UV flashlight

Emits long wave ultraviolet light at a wavelength of 385 Nm. It is powerful enough to make gems and minerals fluorescent even in normal room lighting

Designed for leak detection, glass repair, oil-mining, mineralogy, archaeology, surveillance, chemical probe testing, security inks, document checking, biology, medical applications, chemistry, food checking, water pollution detection etc.

Ready to use, supplied complete with 3 AAA batteries



### ORDERING INFORMATION

CAT NR.	ORD NR.
LED/120	55002

### FEATURES

BATTERY INCLUDES

**3**  
AAA

**27**

## Aluminium Mini Flashlights

LED-110

High quality aluminium flashlights with a soft rubber grip & belt clip

**Beam Distance:** 30 metres

Ideal for maintenance professionals, mechanics, drivers, supervisors etc.

Ready to use, supplied complete with 2 AA & 8 button batteries



Sold as a set of 4



### ORDERING INFORMATION

CAT NR.	ORD NR.
LED/110	55001

### FEATURES

LUMEN	BEAM DISTANCE	RUN TIME	BATTERY INCLUDES
 35	 30 M	 3 H	<b>2</b> + <b>8</b> AA BUTTON