



elizabeth parker
ENGLAND

THE SIGNATURE COLLECTION



THE SIGNATURE COLLECTION

Spring Summer 2022

2022 is going to be the year of the wedding, with couples creating events that are more bespoke and personal to their story than ever before. We have created an exclusive Wedding Collection that brings together some stunning new stones and wedding ready colours.

Discover our new and exclusive Signature Collection, a carefully curated range of exquisite semi - precious stone cufflinks and lapel pins for weddings. With Seven semi-precious stones, there is an elegant colour and stone to compliment some of the most popular wedding colour palettes and themes.

We spent some time delving into weddings and popular themes across the globe to create a selection of designs that will help grooms add a hint of their days colour palette or theme to their look.

A combination of delicate design, natural stones & sophisticated metals.

Staring iconic Elizabeth Parker duos: Black Onyx & Gold, Mother of Pearl & Gold and Sodalite & Rose Gold.

As well as a touch of the unexpected; Blue Aventurine & Rhodium, Rose Quartz & Rose Gold and Green Aventurine & Rhodium and Smokey Mother Of Pearl & Rhodium.

This collection of exclusive cufflinks and lapel pins have been crafted to be worn solo or paired together, order as a set or separately – the choice is yours.

A piece of elegance to celebrate a life changing moment.

THE SIGNATURE COLLECTION

Design Concept

A twist on a timeless design, with a delicate diameter of 14mm and featuring a stone that protrudes from the edge of the casing before dropping down to create a slight concave dip. The Signature Collection pieces will come to life when hit by the light. Our standard cufflink bascule ensure they are easy to put on and wear too. These designs include natural semi-precious stones, so tones and patterns may vary.

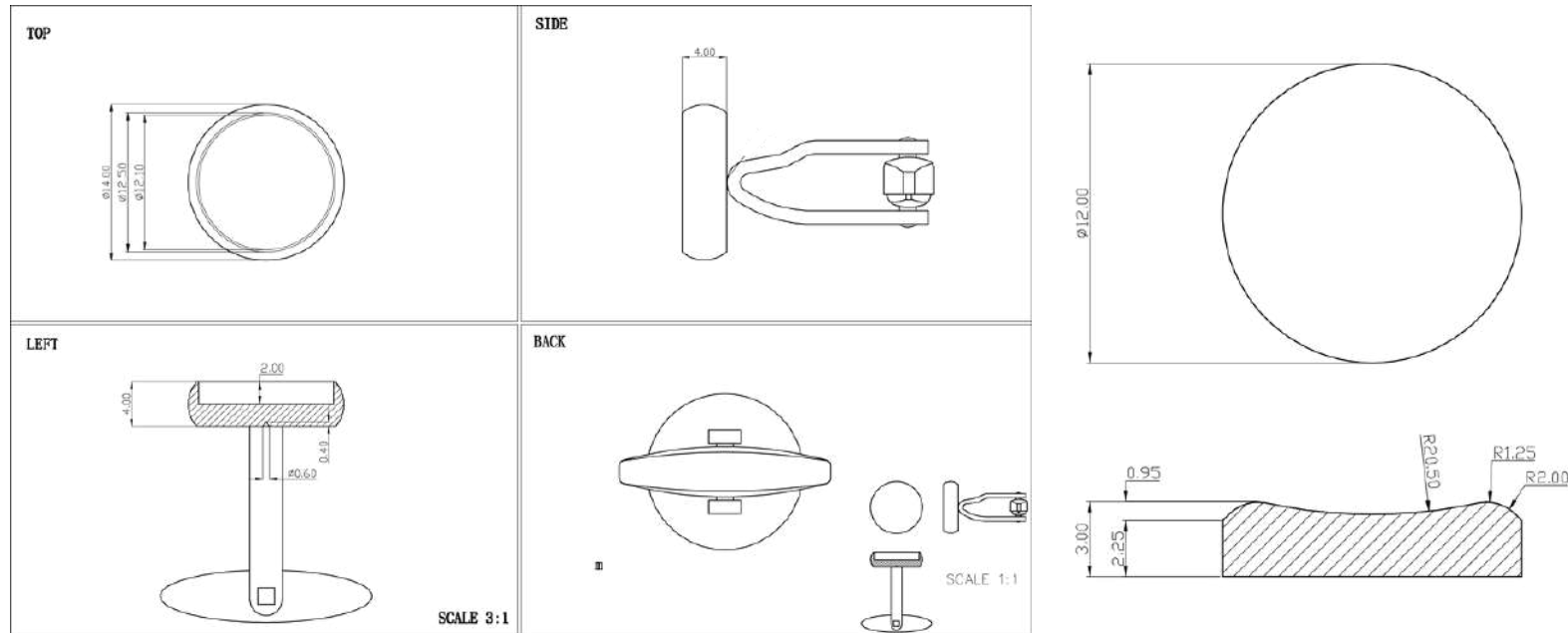

№ 1

ONYX



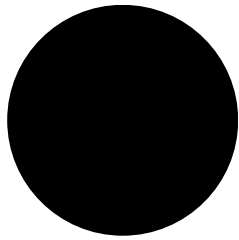

N^o 1

BLACK ONYX / GOLD

Classic / Black Tie/ Exclusive

CONTEMPORARY	TRADITIONAL
EVENING	NATURAL

"Love recognises no barriers, it jumps hurdles, leaps fences, penetrates walls to arrive at its destination, full of hope."

MAYA ANGELOU



Nº 2

MOTHER OF PEARL





Nº 2

MOTHER OF PEARL / GOLD

White Wedding / Romance / Boujee

CONTEMPORARY	TRADITIONAL
EVENING	NATURAL

"...true love is never blind, but rather brings an added light."

P H O E B E C A R Y



NO 3

SODALITE

lemon and thistle



coloursbridesmaid



creative union



emmaline bride



Empiria Studios

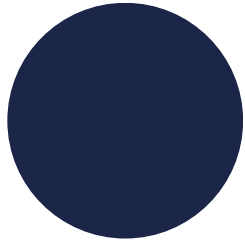

№ 3

SODALITE / ROSE GOLD

Navy/ Midnight Blue Wedding/ Opulent

CONTEMPORARY	TRADITIONAL
SOPHISTICATED	NATURAL

“A happy marriage is a long conversation which always seems too short.”

ANDRÉ MAUROIS



№ 4

GREEN AVENTURINE



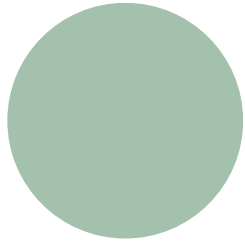

№ 4

GREEN AVENTURINE / SILVER

Tranquil/ Verdant/Soft Green

CONTEMPORARY	TRADITIONAL
SOPHISTICATED	NATURAL

“Happy marriages begin when we marry the ones we love, and they blossom when we love the ones we marry.”

TOM MULLEN



№ 5

ROSE
QUARTZ



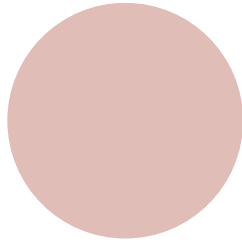

№ 5

ROSE QUARTZ / ROSE GOLD

Pink / Rose Romance / Serenity

CONTEMPORARY	TRADITIONAL
SOPHISTICATED	NATURAL

“One day, in your search for happiness, you discover a partner by your side, and you realise that your happiness has come to help you search.”

ROBERT BRAULT



№ 6

BLUE ADVERTURINE



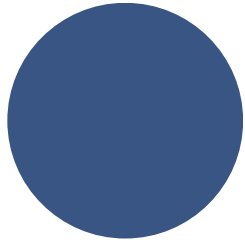

No 6

BLUE AVENTURINE / SILVER

Coastal / Crisp / Serenity

CONTEMPORARY	TRADITIONAL
SOPHISTICATED	NATURAL

“One day, in your search for happiness, you discover a partner by your side, and you realise that your happiness has come to help you search.”

ROBERT BRAULT



№ 7

SMOKEY MOTHER OF PEARL



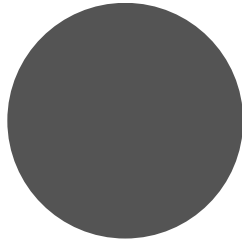

No 7

SMOKEY MOTHER OF PEARL/ SILVER

Grey / Dark / Contemporary

CONTEMPORARY	TRADITIONAL
SOPHISTICATED	NATURAL

“A great marriage is not when the ‘perfect couple’ comes together. It is when an imperfect couple learns to enjoy their differences.”

DAVE MEURER

