

# RESTRAP

A photograph of two cyclists riding away on a wet, paved road in a rural, hilly landscape. The cyclist on the left is wearing a black long-sleeved top, purple shorts, and a black helmet. The cyclist on the right is wearing a tan jacket, black shorts, and a black helmet. Both bikes have panniers. The road is wet and reflects the overcast sky. The background shows rolling hills and a stone wall on the left.

PRODUCT CATALOGUE



04 **ADVENTURE RACE RANGE**

05 **RACE BAR BAG**

06 **RACE AERO BAR BAG**

07 **RACE FRAME BAGS**

09 **RACE STEM BAG**

10 **RACE TOP TUBE BAGS**

12 **RACE SADDLE BAG**

13 **RACE MUSETTE**

14 **RACE SPARES**

15 **CARRY EVERYTHING RANGE**

16 **BAR BAGS**

18 **BAR PACK**

19 **CANISTER BAG**

20 **SADDLE BAGS**

21 **SADDLE PACK**

22 **TOOL POUCH**

23 **FRAME BAGS**

25 **TOP TUBE BAGS**

27 **STEM BAG**

28 **TECH BAG**

29 **EXPEDITION RANGE**

30 **RANDO BAG**

31 **PANNIERS**

32 **FORK BAG**

33 **CARRY CAGE**

34 **DRY BAGS**

35 **CITY RANGE**

36 **CITY LOADER**

37 **CITY BAR BAG**

38 **CITY STEM BAG**

39 **CITY SADDLE BAG**

40 **CITY CARRY HANDLE**

41 **CITY PULL TAB**

42 **STRAP RANGE**

43 **RACK STRAPS**

44 **FRAME STRAP**

45 **FAST STRAPS**

46 **PEDAL STRAPS**

48 **ACCESSORIES**

49 **TRAVEL POUCH**

50 **COFFEE DRIPPER**

51 **QUOC X RESTRAP SANDALS**

52 **HIKE A BIKE HARNESS**

53 **MUSETTE BAG**

54 **LAPTOP SLEEVE**

55 **TOOL ROLL**

56 **LINK BELT**

57 **BICYCLE PROTECTION KIT**

58 **TYRE BOOT KITS**

59 **BUMPER BAR**

60 **ACCESSORIES & CLOTHING**

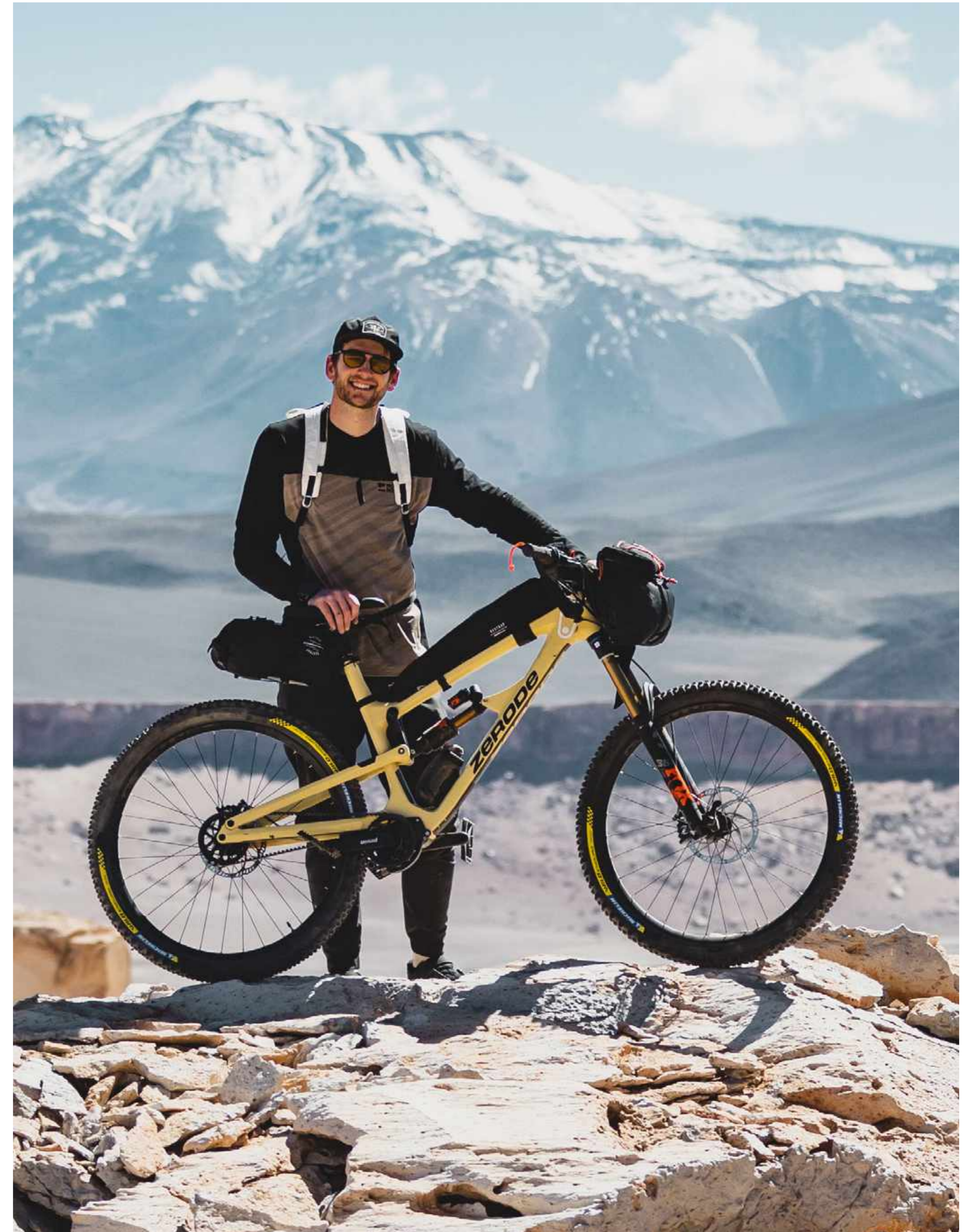



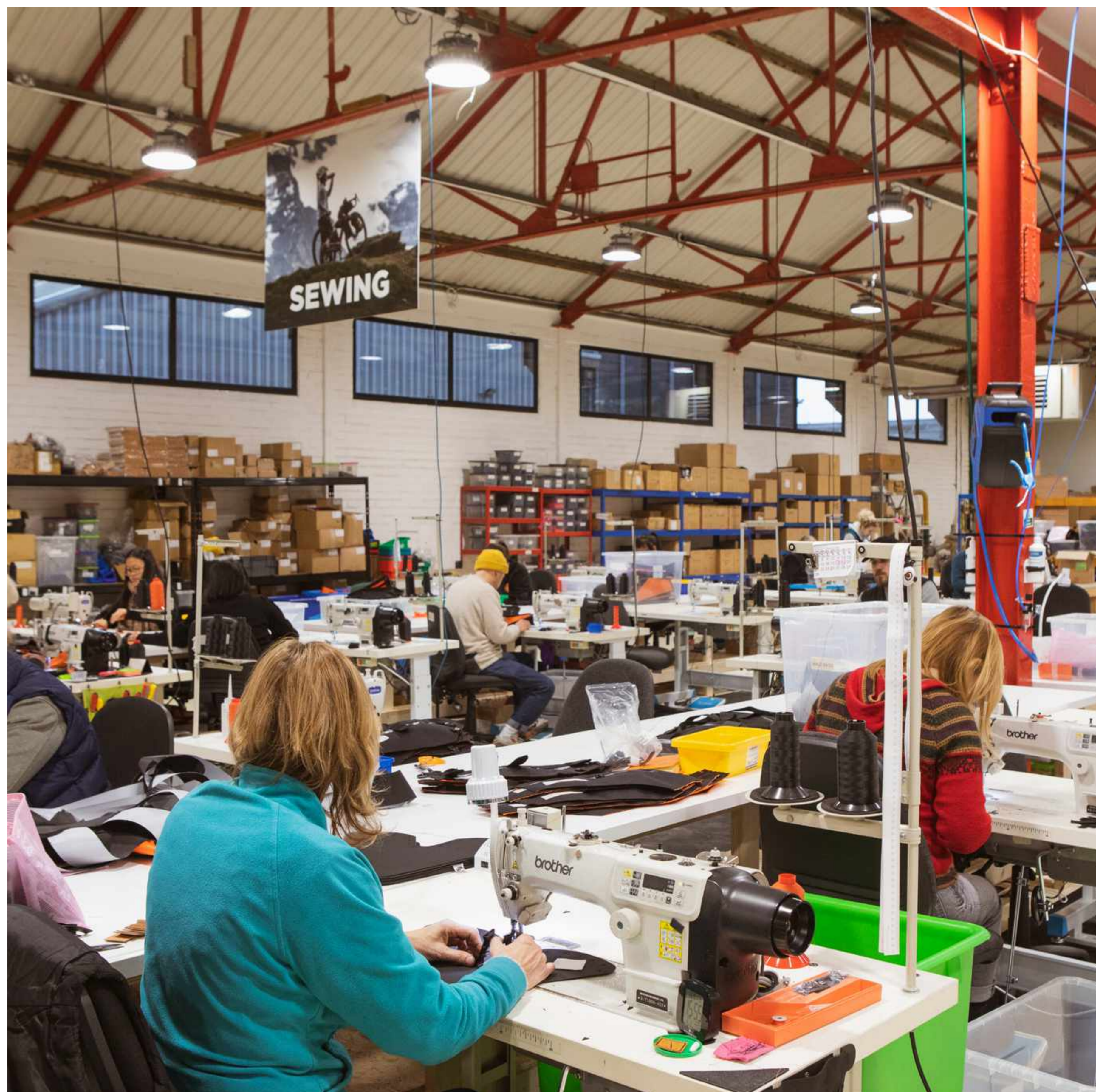

## WHO WE ARE

- 2010** Restrap launches with its first product the Diagonal pedal strap, handmade in the UK. The name Restrap is born as a reference to the straps being made from recycled seatbelt, which continues today.
- 2012** Restrap moves from a back bedroom to its first workshop and launches its first backpack (the Highrise) and first messenger bag (the Loader).
- 2014** Restrap introduces Fidlock buckles into the range and launches its innovative modular backpack system, the Unite.
- 2015** With a lot of time and development, Restrap launches the first iteration of the Carryeverything range, a rackless bag system for bikepacking and cycle touring. With another workshop move around the corner the team continues to grow.
- 2018** Restrap develops its Expedition range (including magnetic Rando Bag) and introduces tape sealing equipment, allowing them to take production of dry bags in-house. Restrap moved into a new 6500sqft workshop, expanding the range and capacity.
- 2019** Restrap launches the City range; bags designed purposely to work with the complicated design of folding bikes.
- 2020** Restrap launches the Adventure Race range aimed at ultra and endurance racers.
- 2021** The start of 2021 saw us move into our new factory on Kirkstall Road, Leeds with the addition of new tooling and machinery we continue to manufacture in-house and design and develop innovative luggage for the cycling industry.

## RESTRAP RANGES

### ADVENTURE RACE RANGE

Aimed at ultra distance riders, Restrap has pushed the boundaries of its design and manufacturing capabilities to produce the lightest complete race range yet, weighing less than 1kg in total.

### CARRY EVERYTHING RANGE

Touring made simple! Our saddle bags, frame bags and bar bags are all made from the highest grade, military waterproof material, with each one adaptable to any frame, any rider, and any load.

### EXPEDITION RANGE

Designed for racks and baskets, the expedition range is for long distance rides where a larger volume of luggage is required. Also includes our straps and dry bags.

### CITY RANGE

Speed across the city with our range especially for folding bikes. The Restrap City range makes carrying any essential items easy and practical. Waterproof and handmade in the UK.





**ADVENTURE RACE RANGE**



## RACE BAR BAG

Page 5

The Adventure Race Bar Bag is the ideal handlebar storage solution for ultra-distance riding, audaxes and races. The minimalist hardshell holster is constructed with a WX21 technical outer and durable nylon inner lining with Hypalon accents. The holster is shaped to optimise performance, whilst keeping weight to a minimum.

Foam spacers and spring-loaded cam locks provide an easy and reliable attachment to your handlebars, whilst a reflective elastic cord retention strap aids stability around the head tube. A 100% waterproof 7L Dry Pack has been designed specifically for the Race Bar Bag, featuring a roll-top closure, reflective detailing and stretch mesh side pockets that provide accessible storage for food, gloves and other essentials on the go.

## TECHNICAL DETAILS

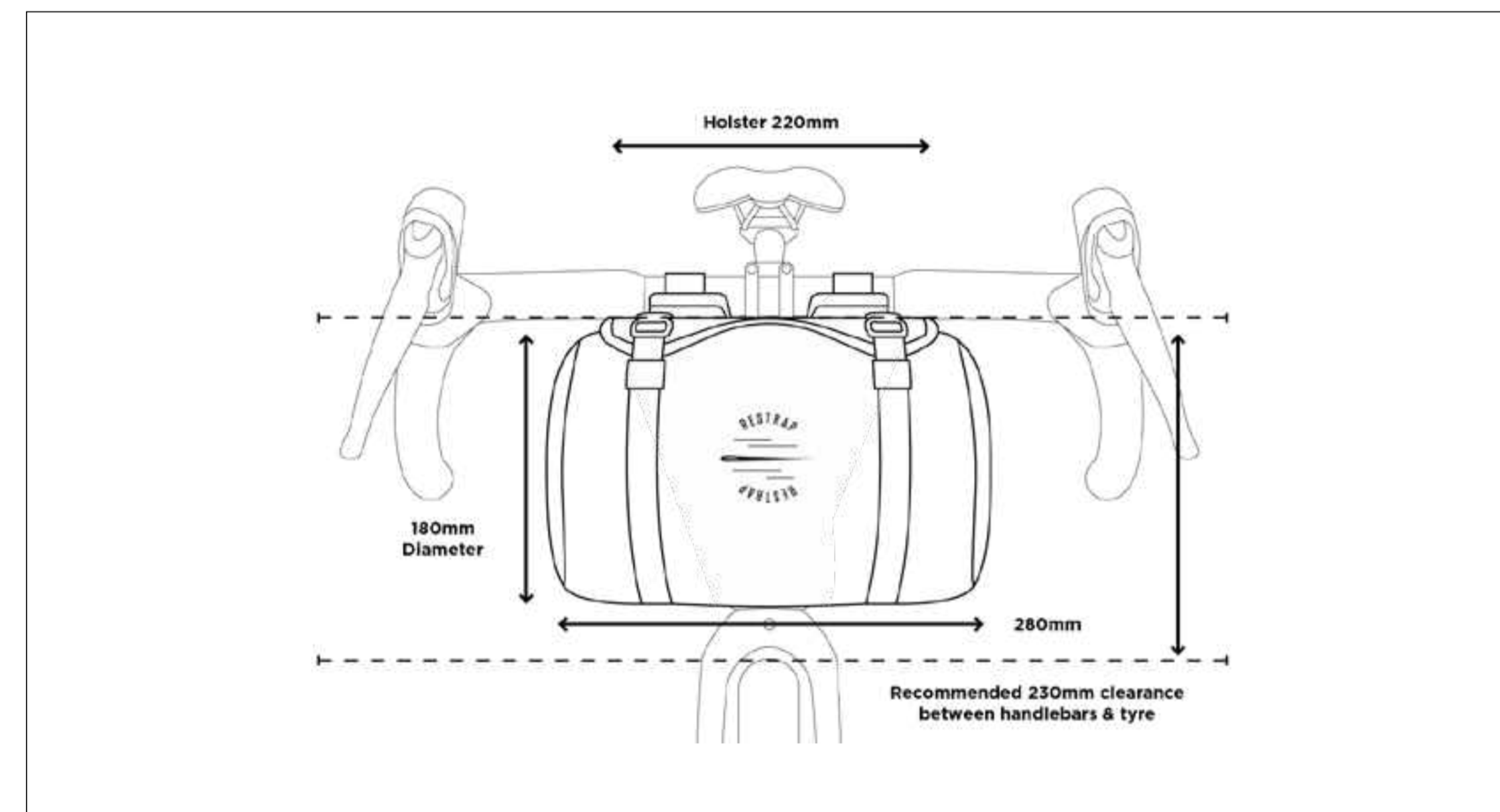

Materials	<b>Body:</b> X21 Waterproof Materials <b>Dry Pack:</b> 210 Denier Nylon with Mesh Pockets <b>Webbing:</b> Nylon
Size	<b>7L:</b> 280mm x 180mm x 180mm
Weight	<b>Race Bar Bag:</b> 325g
Product Codes	<b>Race Bar Bag - RS_RBB_HOR_BLK</b>
HS Code	42029211

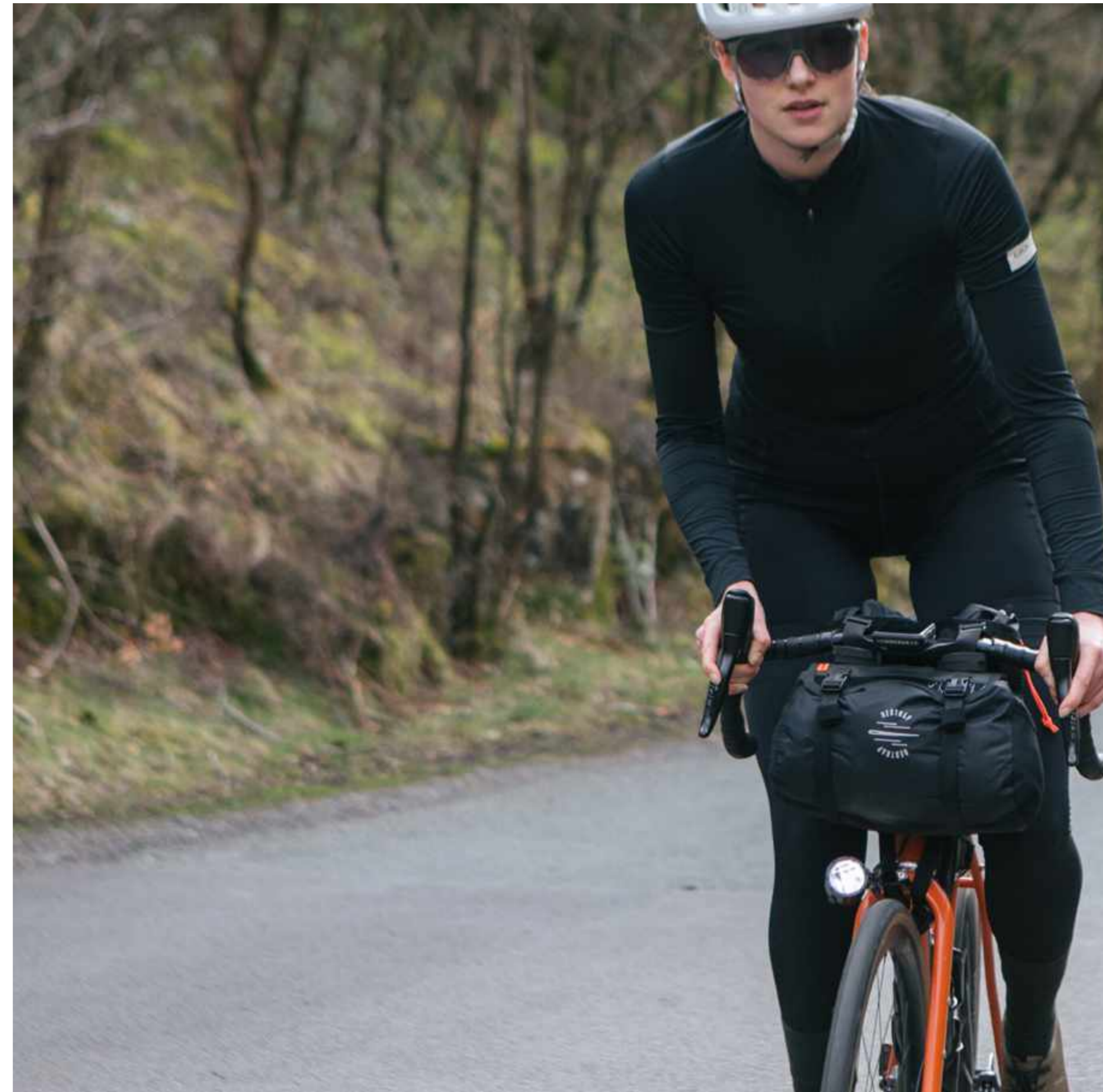

HANDLEBAR BAGS

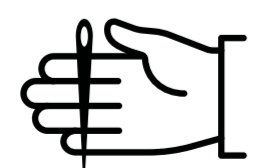

HANDMADE IN UK



LIFETIME WARRANTY



## RACE AERO BAR BAG

Page 6

The Adventure Race Aero Bar bag uses our unique laser cut holster design for ultra-distance events, audaxes and races when using aero bars. The holster has a dedicated 7.0L drybag which is front-loaded and easy to take on and off the bike.

The dry bag is 100% waterproof and secured with a Fidlock™ magnetic buckle that's easy to adjust, even whilst wearing gloves. Reflective detailing on the dry bag also aids visibility during night time riding. The holster is a hardshell construction with an X21 technical outer. It also includes laser cut Hypalon loops to make it fully adjustable for different aero bars, whilst its elastic cord allows storage between the bars for smaller items.

### TECHNICAL DETAILS

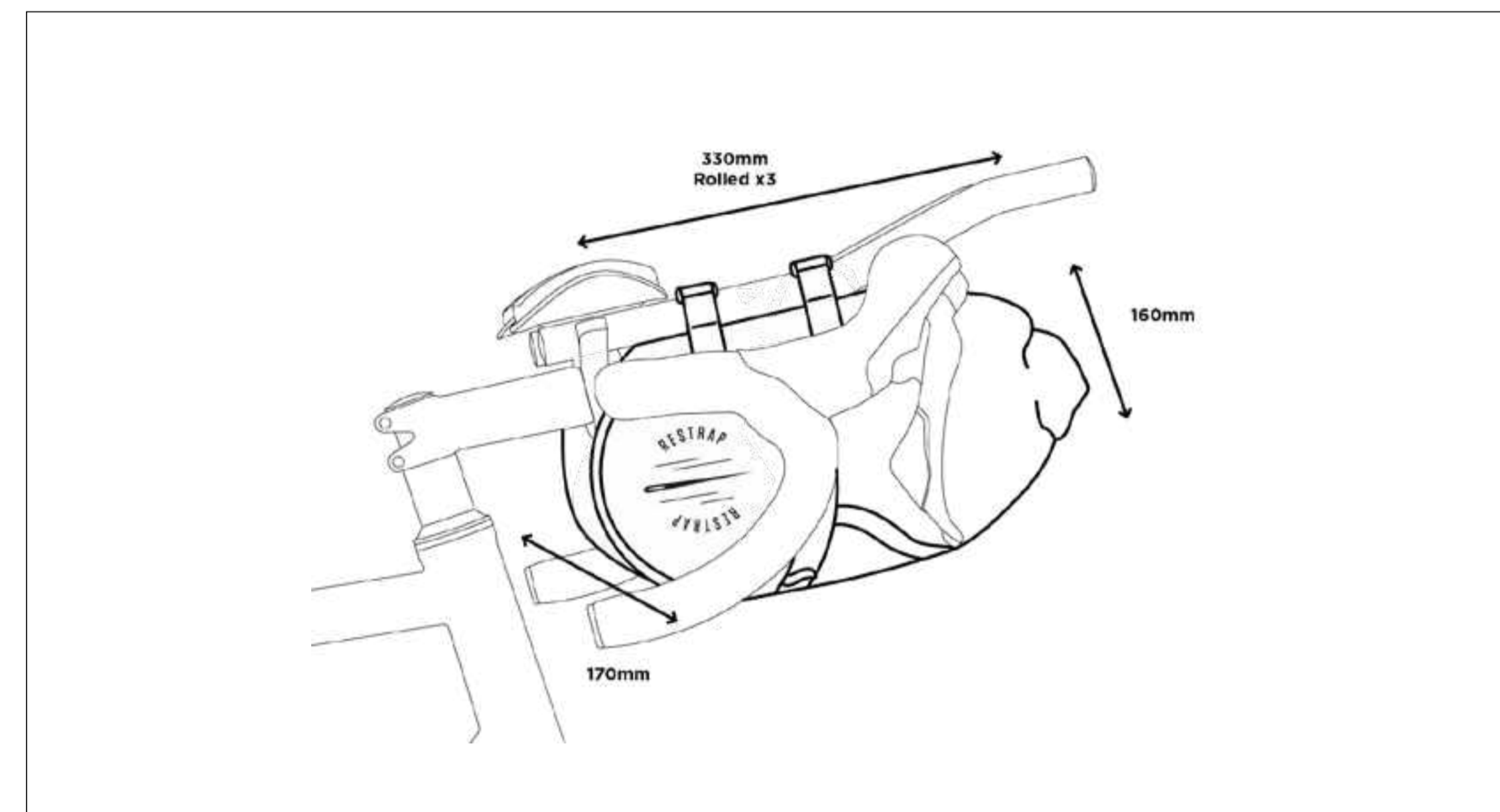

Materials	<b>Body:</b> X21 Waterproof Materials <b>Dry-Bag:</b> 210 Denier Nylon <b>Webbing:</b> Nylon <b>Straps:</b> Hypalon <b>Includes Fidlock Fittings</b>
Size	<b>7L:</b> 36cm x 16cm x 17cm
Weight	<b>Holster:</b> 207g <b>With Dry Bag:</b> 265g
Product Codes	<b>Race Aero Bar Bag - RS_RBB_STD_BLK</b>
HS Code	42029211



HANDLEBAR BAGS

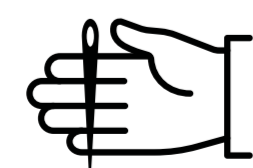

HANDMADE IN UK



LIFETIME WARRANTY



## RACE FRAME BAG - SMALL

Page 7

The Adventure Race Frame Bag is a durable and lightweight bag, ideal for ultra-distance racing and audax riding. Built to be practical and functional, an X21 technical waterproof outer, waterproof 6oz nylon inner lining and YKK aquaguard zips keep inclement weather at bay, whilst reflective detailing boosts visibility and safety when riding through the night.

A Hypalon pocket cover helps to shield the zips from downpours whilst a cut out towards the front of the bag allows for device cable routing to the front of the bike. Pockets on each side and internal velcro divider in the main pocket keep your essentials organised and easy to reach. An extra hidden cable slot is also provided at the front of the bag for dynamo and other device cables.

## TECHNICAL DETAILS

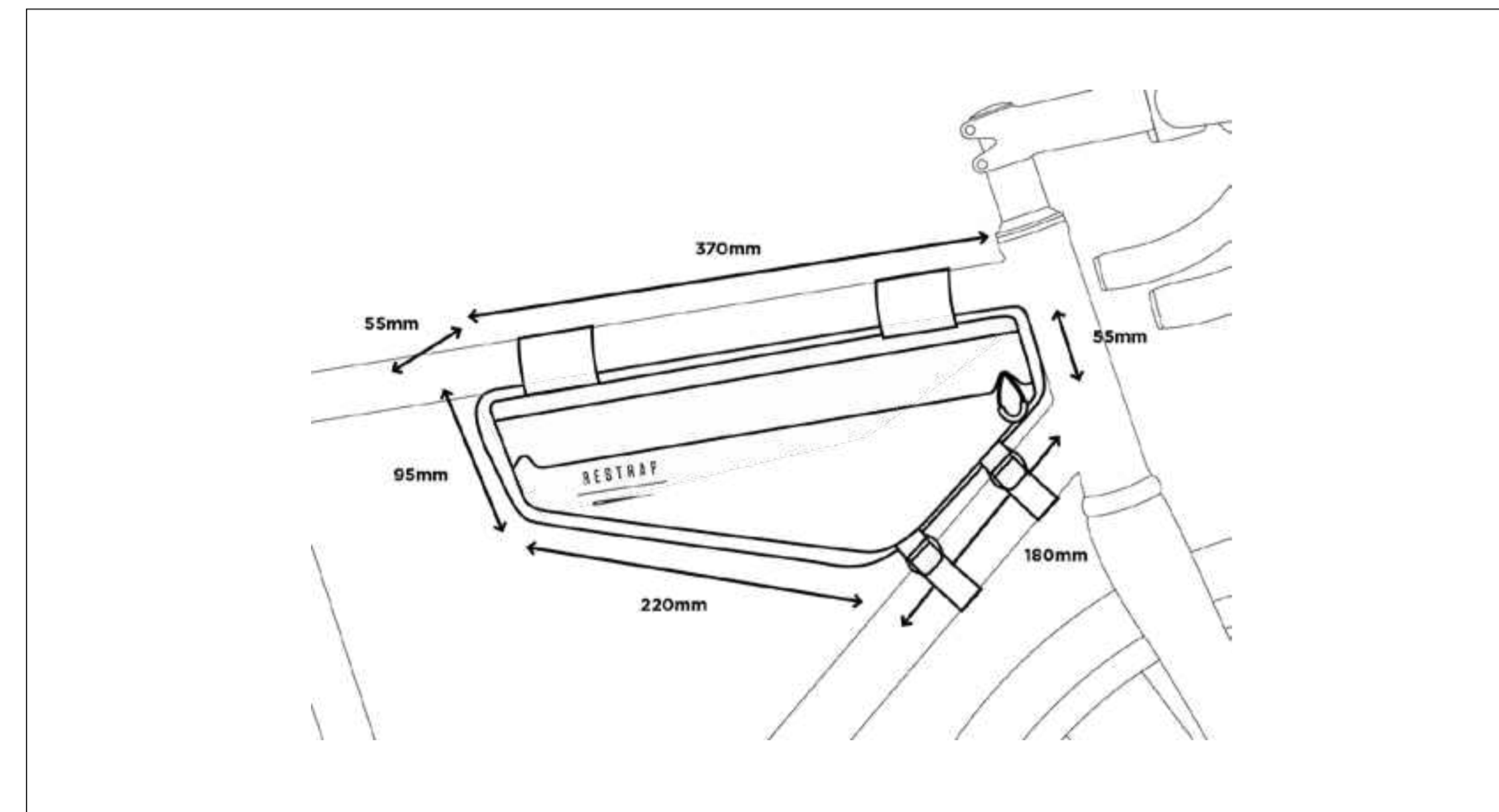

Materials	<b>Body:</b> X21 Waterproof Materials & Hypalon <b>Lining:</b> 210 Denier Nylon <b>Webbing:</b> Nylon <b>Zipper:</b> YKK Aquaguard
Size	<b>3L :</b> 370mm x 180mm x 55mm
Weight	180g
Product Codes	<b>Race Frame Bag - Small - RS_RFB_STD_BLK</b>
HS Code	42029211

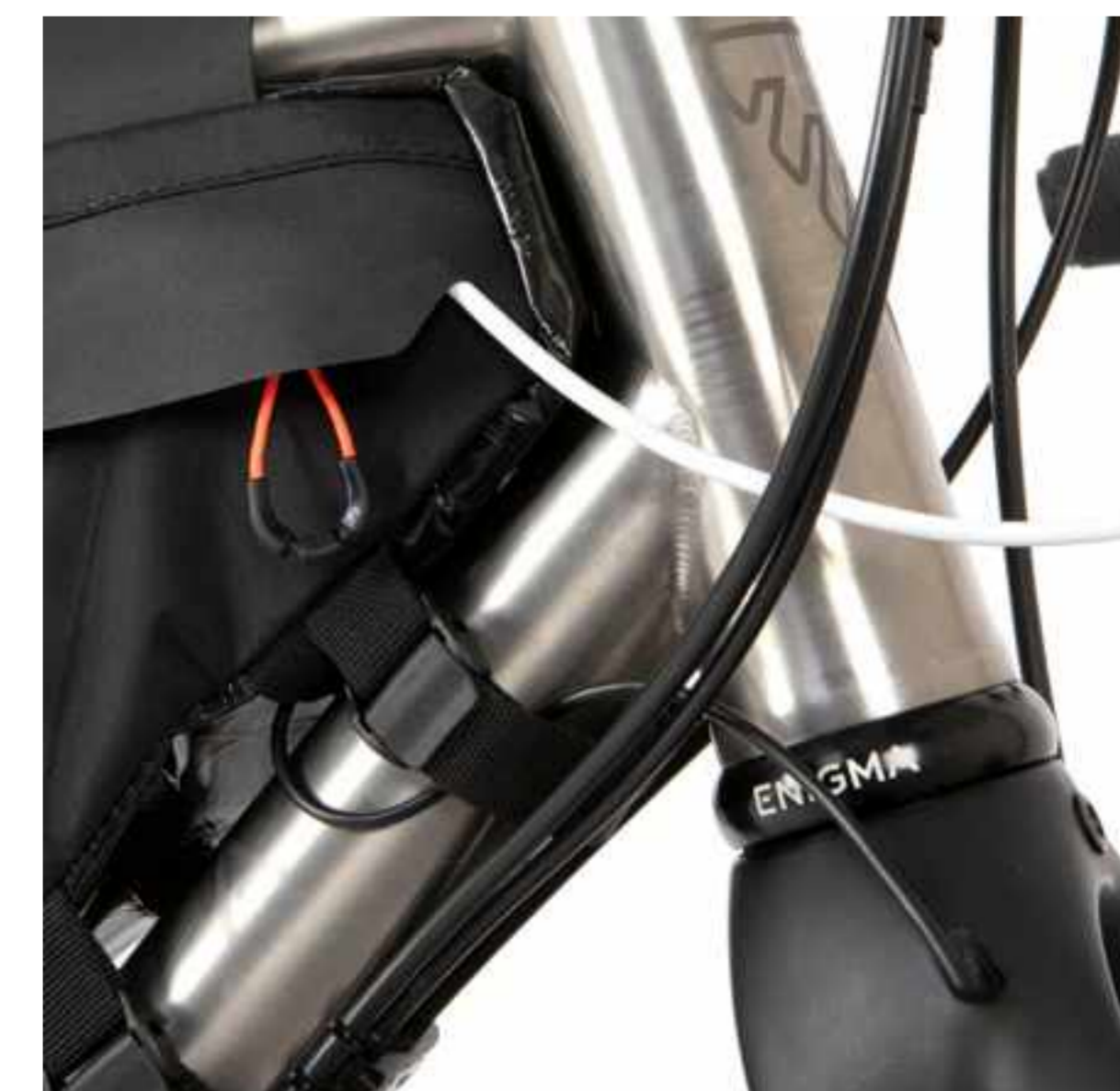
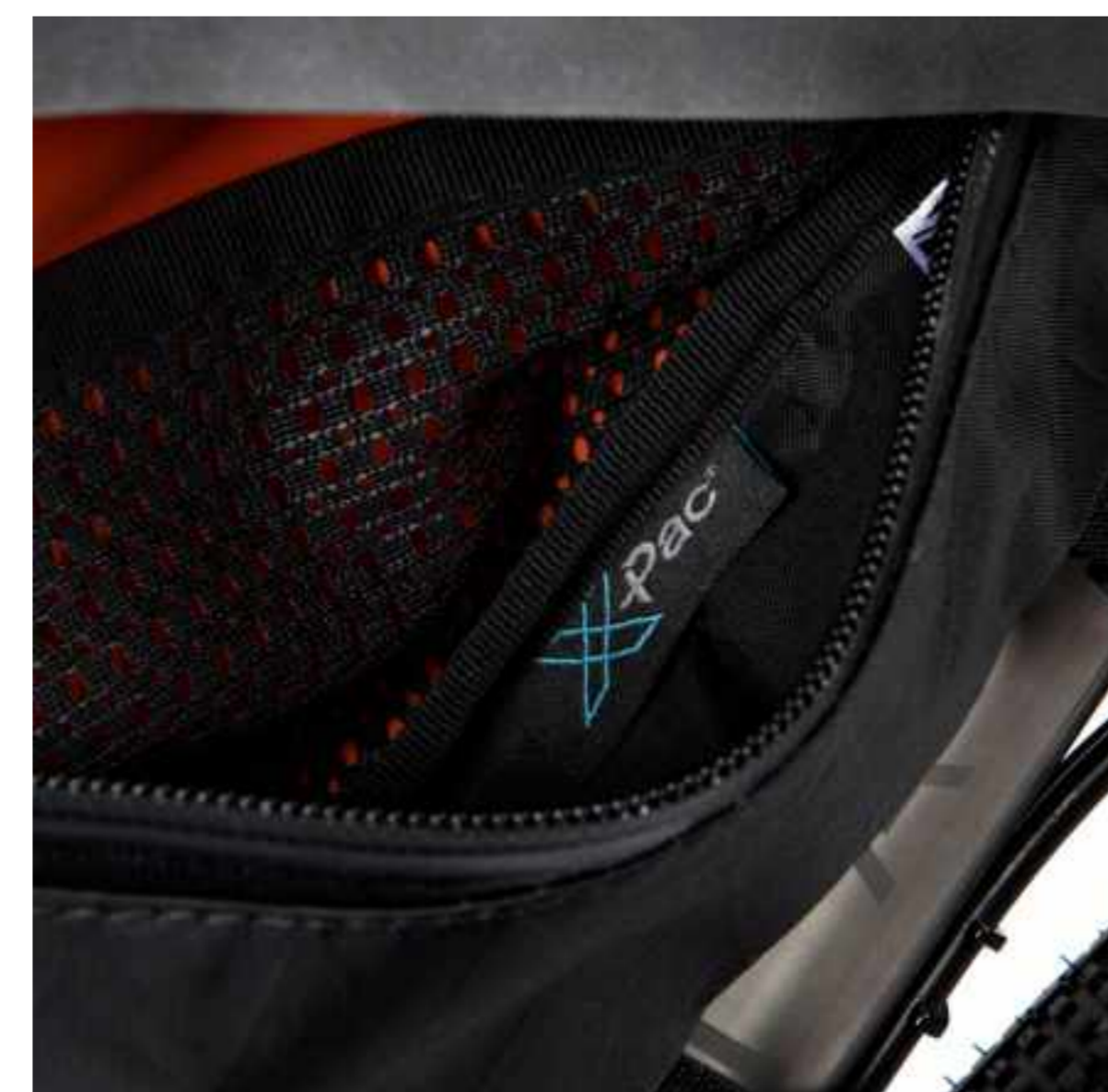

FRAME BAGS

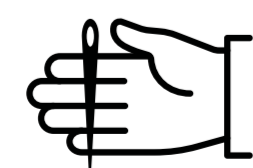

HANDMADE IN UK



LIFETIME WARRANTY



## RACE FRAME BAG - LARGE

Page 8

The Adventure Race Frame Bag is a durable and lightweight bag, ideal for ultra-distance racing and audax riding. Built to be practical and functional, an X21 technical waterproof outer, waterproof 6oz nylon inner lining and YKK aquaguard zips keep inclement weather at bay, whilst reflective detailing boosts visibility and safety when riding through the night.

A Hypalon pocket cover helps to shield the zips from downpours whilst a cut out towards the front of the bag allows for device cable routing to the front of the bike. Pockets on each side and internal velcro divider in the main pocket keep your essentials organised and easy to reach. An extra hidden cable slot is also provided at the front of the bag for dynamo and other device cables.

## TECHNICAL DETAILS

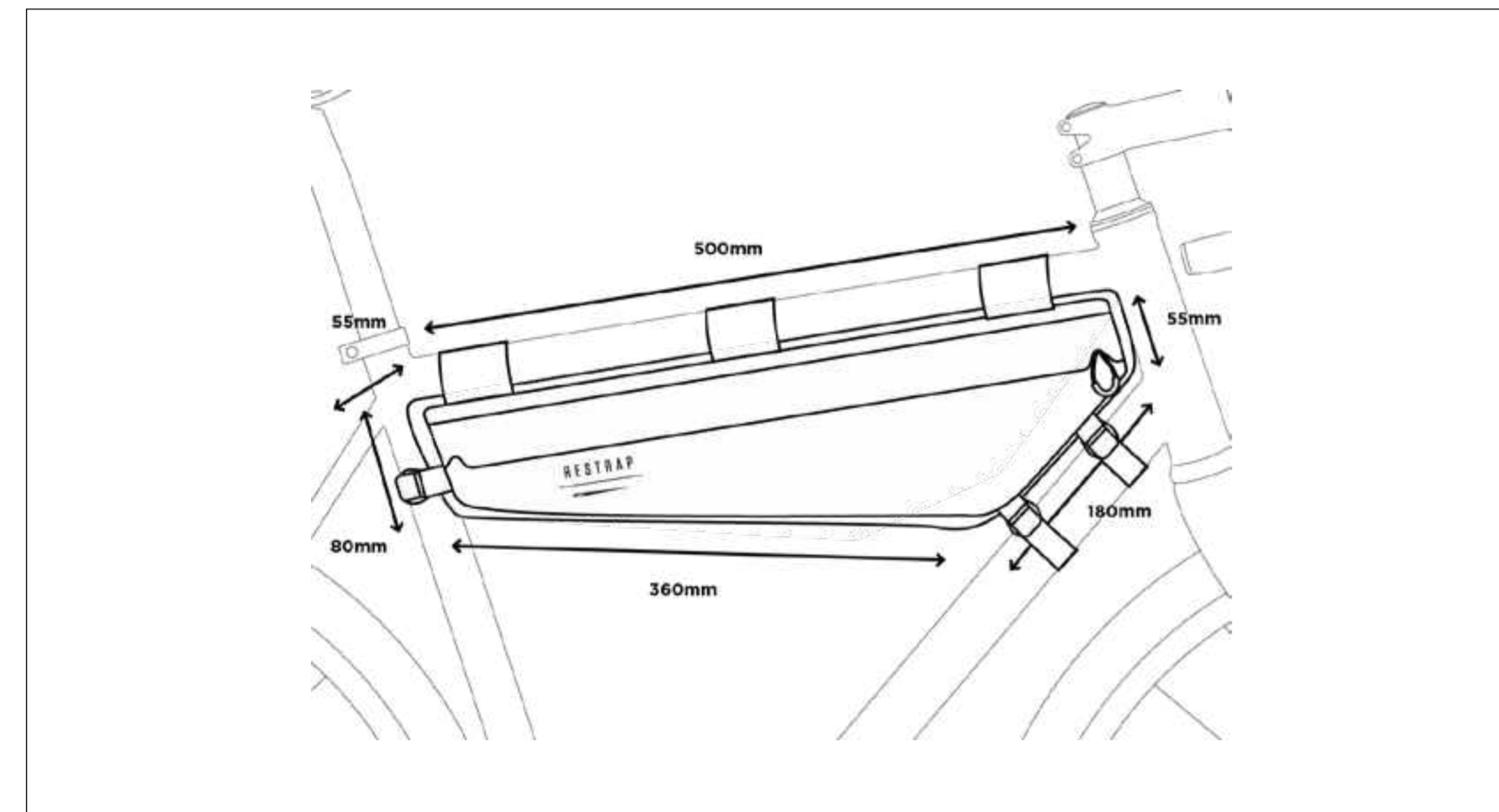

Materials	<b>Body:</b> X21 Waterproof Materials & Hypalon <b>Lining:</b> 210 Denier Nylon <b>Webbing:</b> Nylon <b>Zipper:</b> YKK Aquaguard
Size	<b>4.2L</b> : 500mm x 180mm x 55mm
Weight	240g
Product Codes	<b>Race Frame Bag - Large</b> - RS_RFB_LRG_BLK
HS Code	42029211

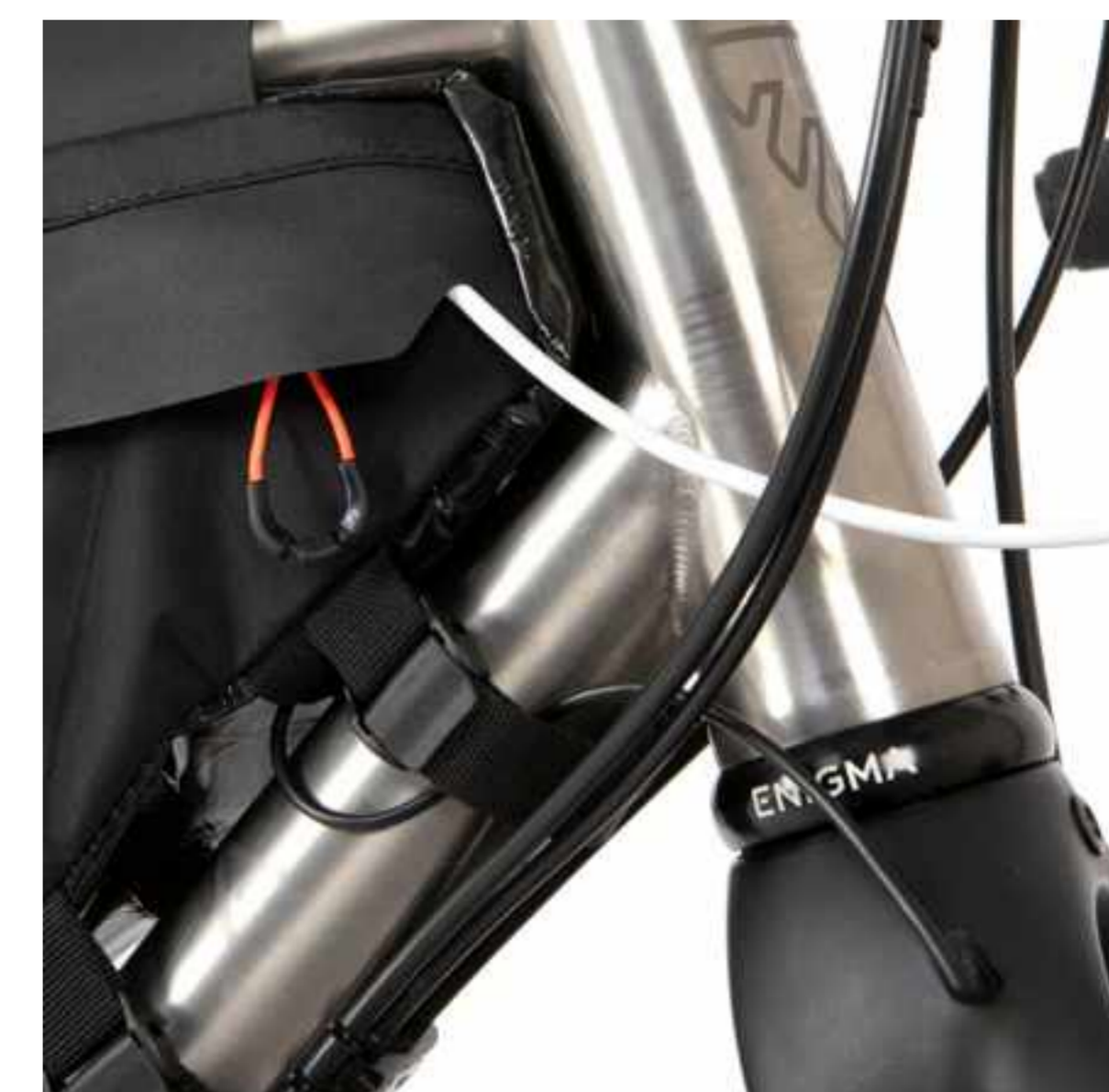

FRAME BAGS

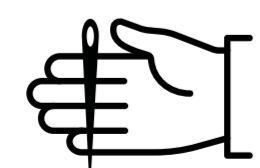

HANDMADE IN UK



LIFETIME WARRANTY



## RACE STEM BAG

Page 9

The Adventure Race Stem Bag offers a highly adjustable and accessible storage solution for nutrition, tech, clothing and more. Multiple Hypalon MOLLE mounts and double sided velcro loops deliver a huge array of mounting possibilities. Our innovative, single pull drawcord closure, allows for effortless one-handed access into the bag when on the move. One upward pull on the Hypalon tab or shock cord opens or closes the bag respectively, whilst the internal stiffener aids easy access and helps the durable and waterproof VX21 outer hold its shape. Stretch mesh pockets offer additional external storage and an extendable nylon interior provides the option to boost the internal capacity when resupplying for the next leg of your journey. Both the shock cord and our signature Race Range heat-pressed logo are reflective, assisting visibility in low-light conditions and at night.

## TECHNICAL DETAILS

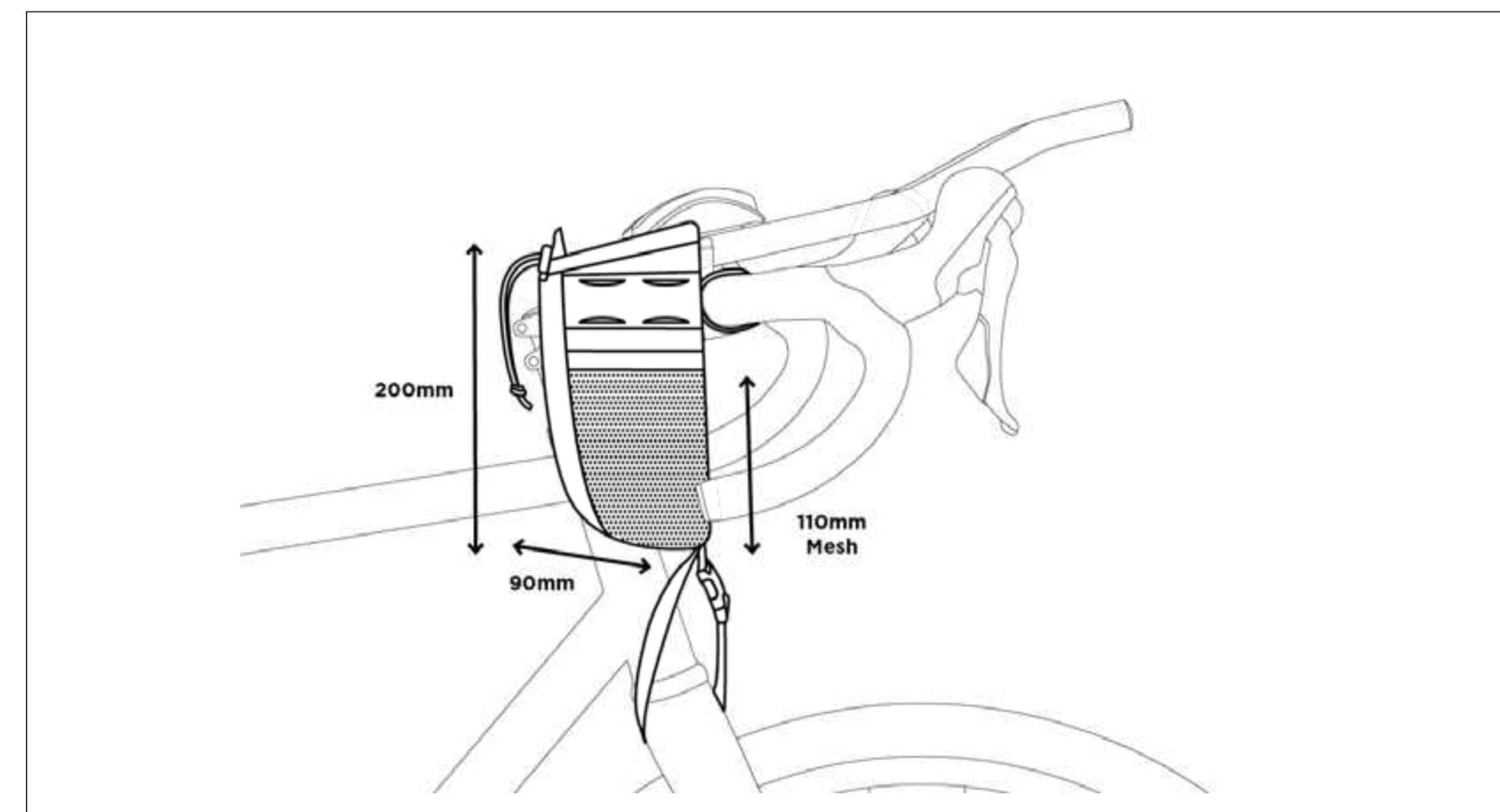

Materials	<b>Body:</b> X21 Waterproof Materials & Hypalon <b>Lining:</b> 210 Denier Nylon <b>Webbing:</b> Nylon <b>Pull-cord:</b> Reflective Paracord
Size	<b>1.1L:</b> 90mm x 200mm
Weight	86g
Product Codes	<b>Race Stem Bag</b> - RS_SBR_STD_BLK
HS Code	42029211

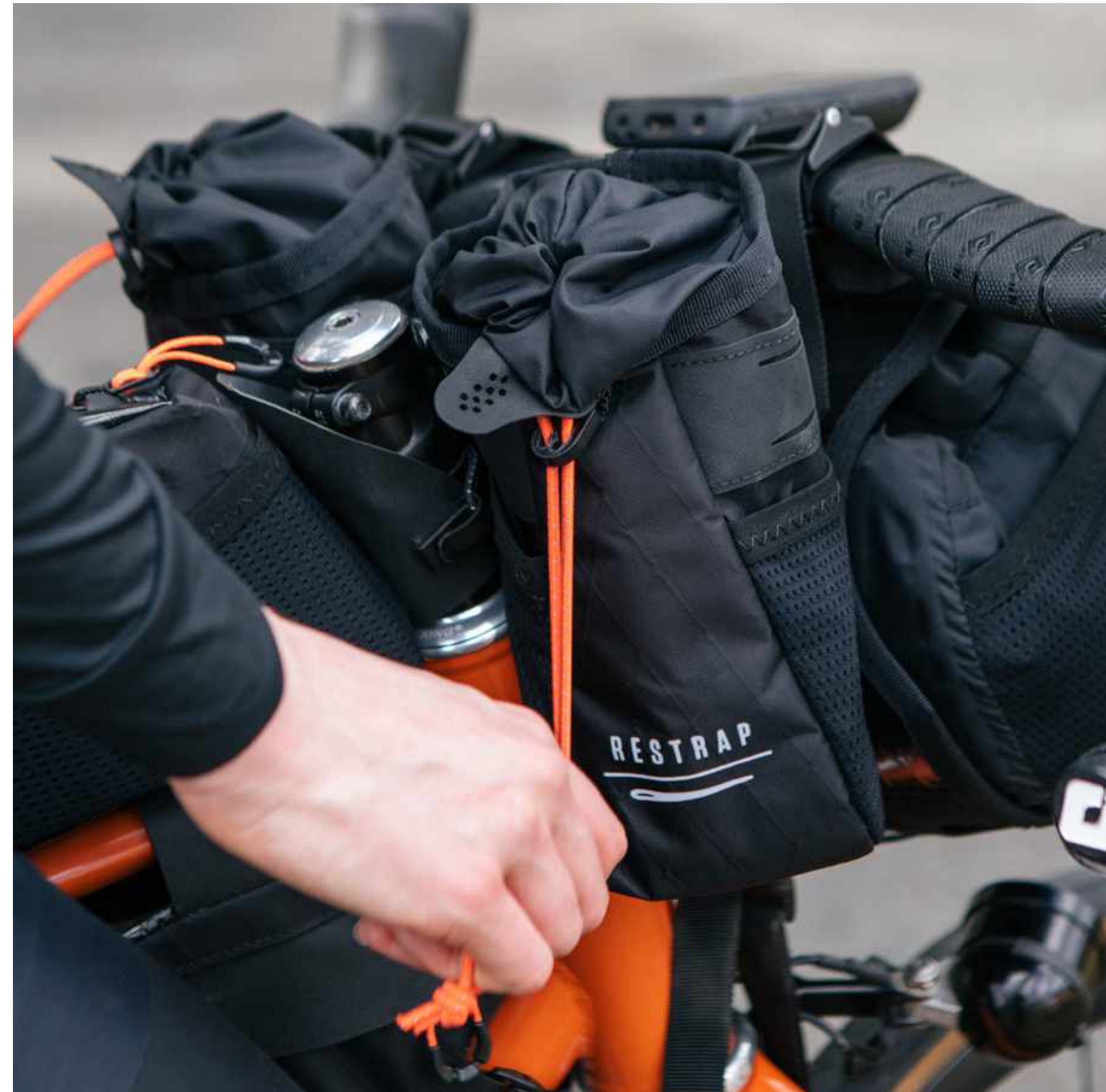

COCKPIT BAGS

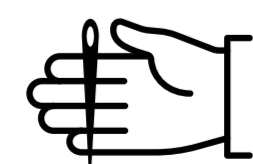

HANDMADE IN UK



LIFETIME WARRANTY



## RACE TOP TUBE BAG

Page 10

Durable and lightweight, the Adventure Race Top Tube Bag is designed with ultra-distance racing and audaxing in mind. An X21 technical waterproof outer, waterproof 6oz nylon inner lining and YKK aquaguard two-way zip keeps inclement weather at bay, whilst reflective detailing boosts visibility and safety when riding through the night.

Built to be practical and functional, the bag is held firmly in place with a rubberised velcro strap and an adjustable MOLLE hypalon fitting, which allows the bag to function seamlessly with all Restrap Frame Bags. A rigid internal plastic structure keeps the bag upright and stable and the universal headset fitting accommodates all headsets, including bikes with a low stack height. A stretch mesh side pocket provides storage for nutrition, wrappers and other on-the-fly essentials.

## TECHNICAL DETAILS

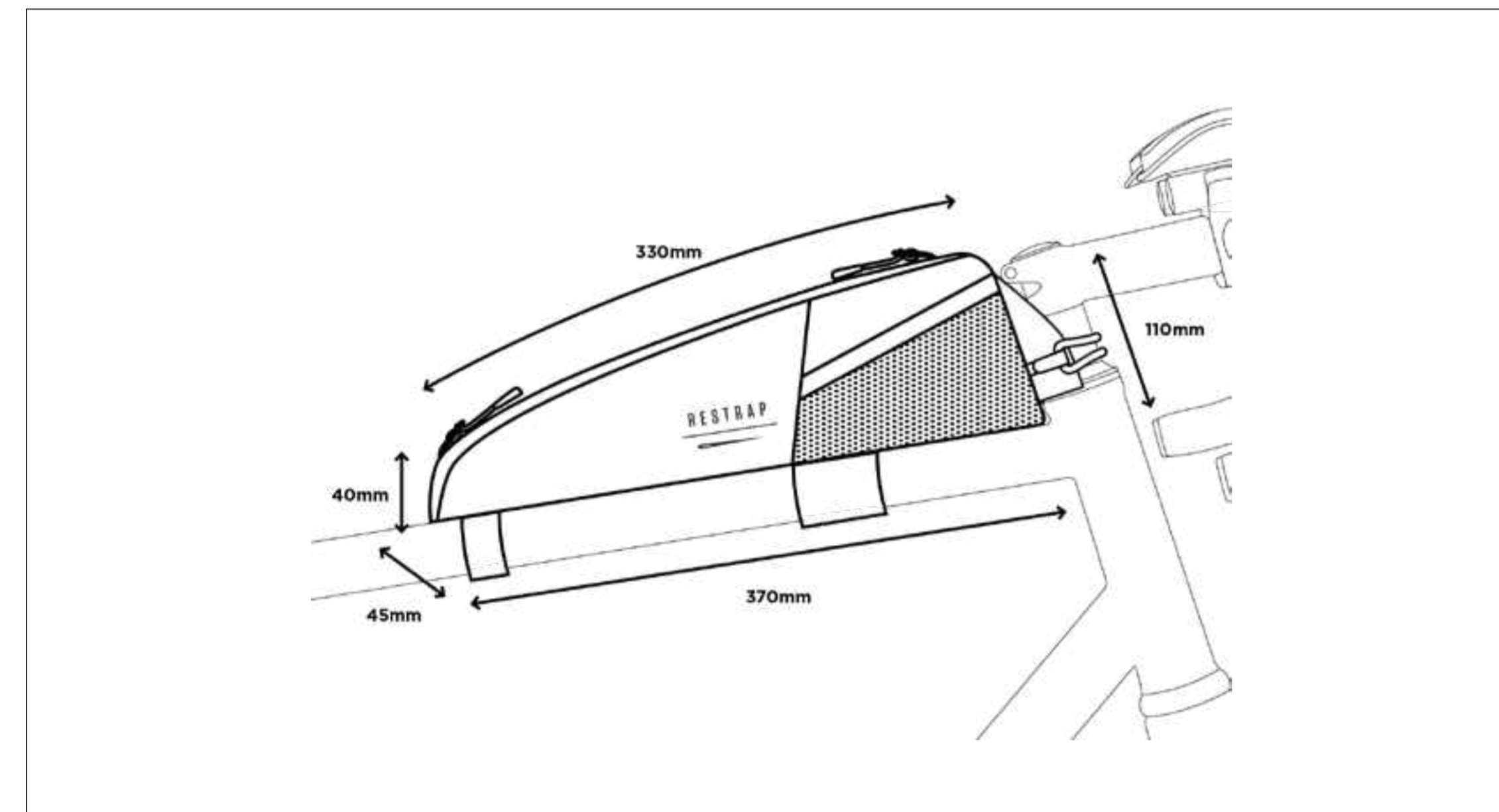

Materials	<b>Body:</b> X21 Waterproof Materials & Hypalon <b>Lining:</b> 210 Denier Nylon <b>Webbing:</b> Nylon <b>Zipper:</b> Two-Way YKK Aquaguard
Size	<b>1.5L:</b> 370mm x 110mm x 45mm
Weight	183g
Product Codes	<b>Race Top Tube Bag</b> - RS_RTT_STD_BLK
HS Code	42029211



COCKPIT BAGS

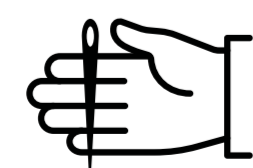

HANDMADE IN UK



LIFETIME WARRANTY



## RACE TOP TUBE BAG - LONG

Page 11

Durable and lightweight, the Adventure Race Top Tube Bag is designed with ultra-distance racing and audaxing in mind. An X21 technical waterproof outer, waterproof 6oz nylon inner lining and YKK aquaguard two-way zip keeps inclement weather at bay, whilst reflective detailing boosts visibility and safety when riding through the night.

Built to be practical and functional, the bag is held firmly in place with a rubberised velcro strap and an adjustable MOLLE hypalon fitting, which allows the bag to function seamlessly with all Restrap Frame Bags. A rigid internal plastic structure keeps the bag upright and stable and the universal headset fitting accommodates all headsets, including bikes with a low stack height. A stretch mesh side pocket provides storage for nutrition, wrappers and other on-the-fly essentials.

### TECHNICAL DETAILS

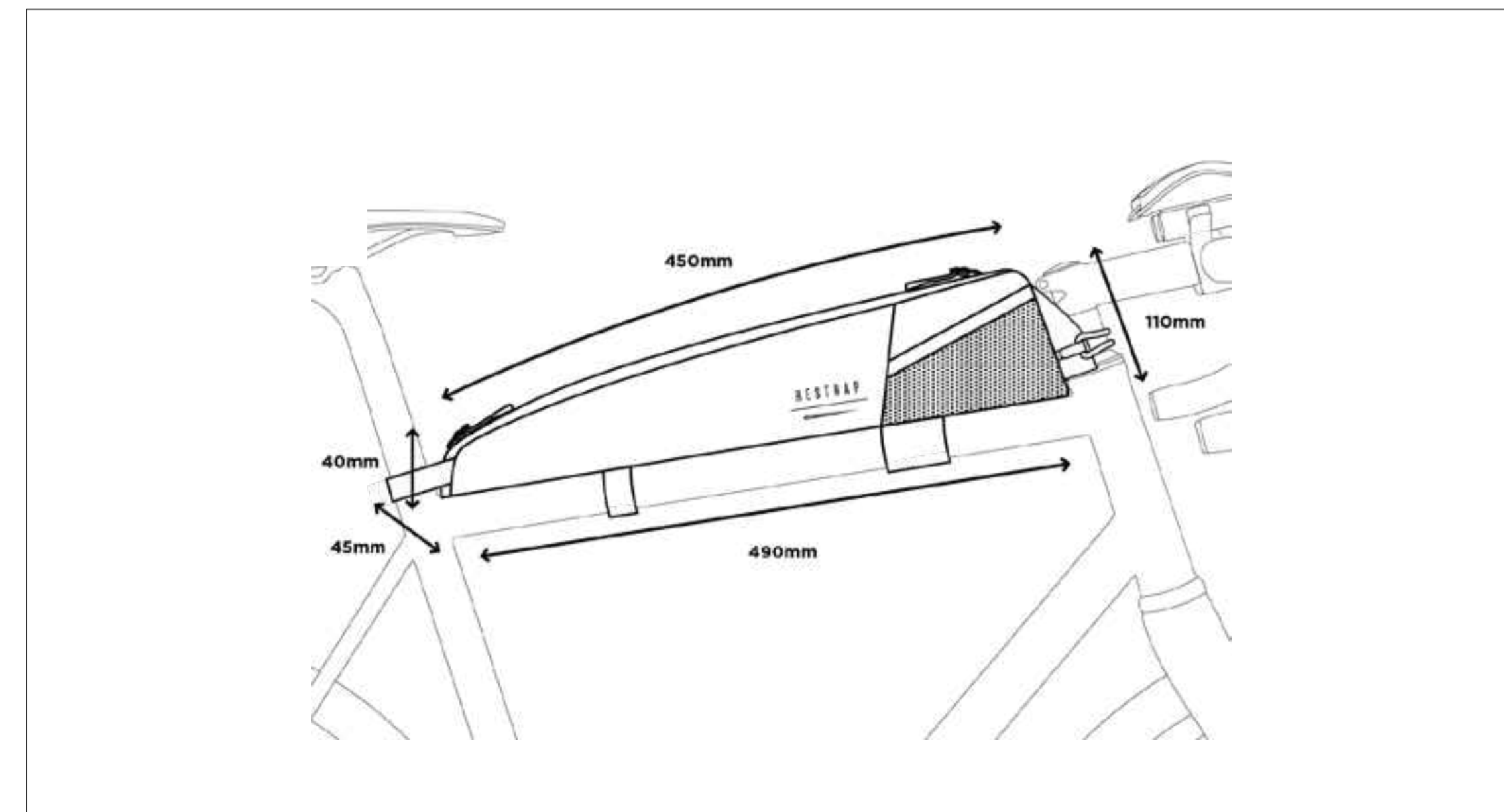

Materials	<b>Body:</b> X21 Waterproof Materials & Hypalon <b>Lining:</b> 210 Denier Nylon <b>Webbing:</b> Nylon <b>Zipper:</b> Two-Way YKK Aquaguard
Size	<b>2L:</b> 370mm x 110mm x 45mm
Weight	243g
Product Codes	<b>Race Top Tube Bag - Long - RS_RTT_LRG_BLK</b>
HS Code	42029211



COCKPIT BAGS

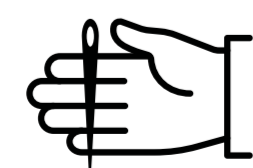

HANDMADE IN UK



LIFETIME WARRANTY



## RACE SADDLE BAG

Page 12

The Adventure Race Saddle Bag uses a laser-cut holster design and is built for ultra-distance riding, audaxes and races. The holster has a dedicated 7.0L drybag that is 100% waterproof and is secured with a Fidlock™ magnetic buckle that's easy to adjust, even whilst wearing gloves. Nylon webbing, Hypalon straps and foam blocks secure the holster around the seat post, keeping the bag securely in place without sway.

The holster is a hardshell construction with an X21 technical outer, and includes Hypalon MOLLE system for additional strapping whilst further Hypalon detailing aids durability and prevents scuffs and scratches. Reflective detailing on the dry bag adds visibility during night time riding.

## TECHNICAL DETAILS

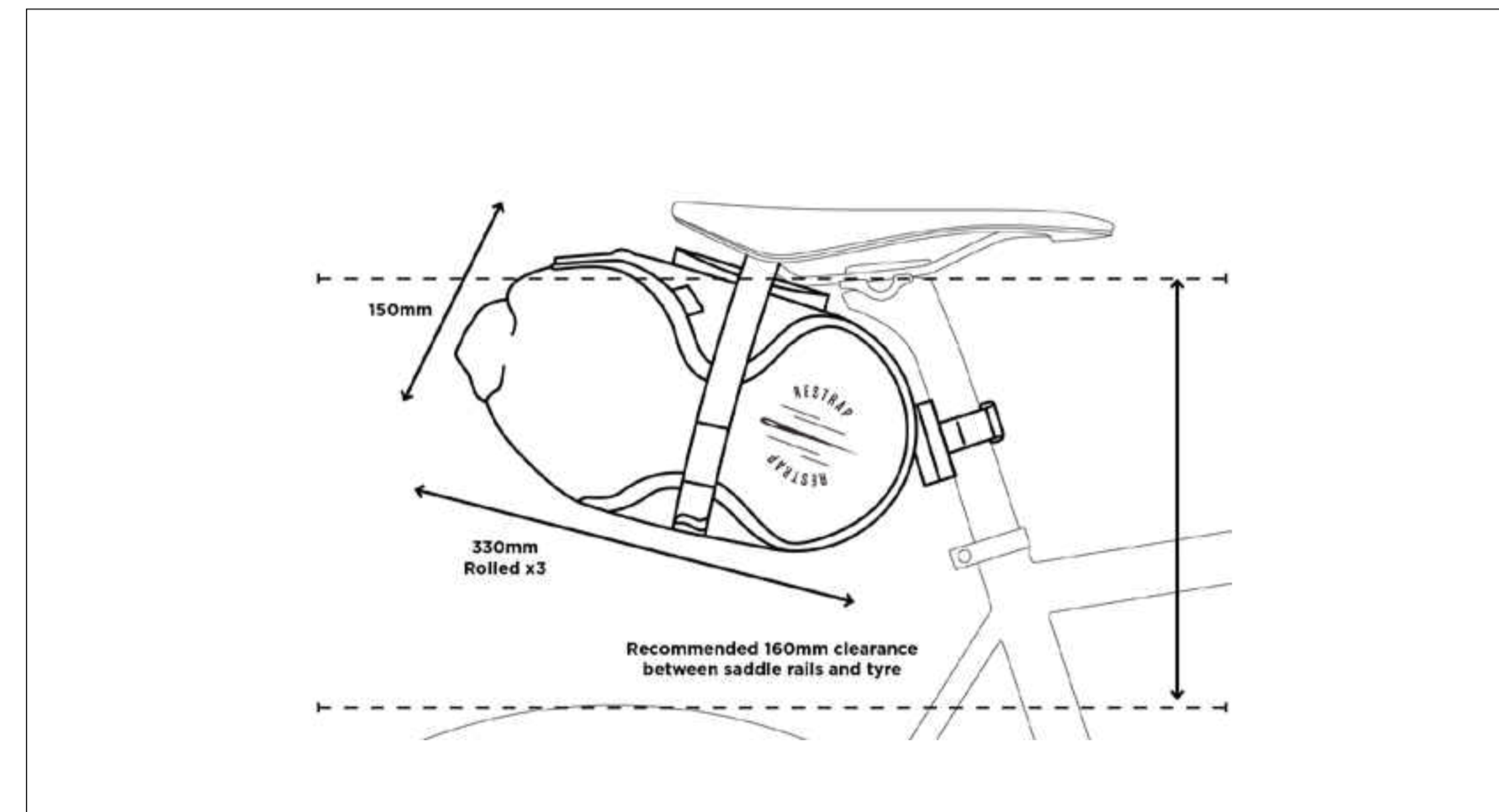

Materials	<b>Body:</b> X21 Waterproof Materials <b>Dry-Bag:</b> 210 Denier Nylon <b>Webbing:</b> Nylon <b>Strap:</b> Hypalon <b>Includes Fidlock Fittings</b>
Size	<b>7L:</b> 330mm wide x 150mm diameter
Weight	250g
Product Codes	<b>Race Saddle Bag - RS_RSB_STD_BLK</b>
HS Code	42029211

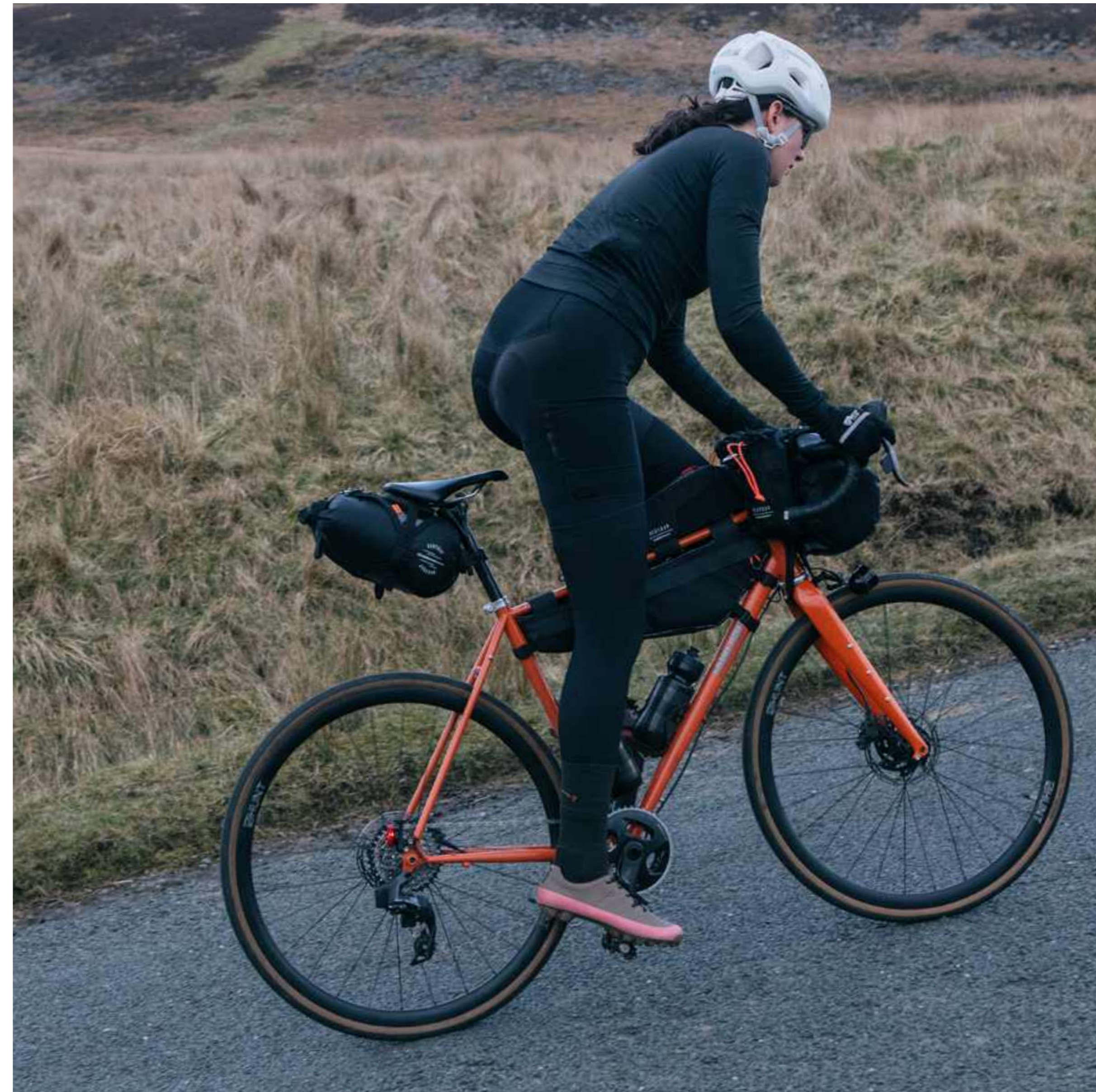

SADDLE BAGS



HANDMADE IN UK



LIFETIME WARRANTY



## RACE MUSETTE

Page 13

The Adventure Race Musette Bag is a stylish addition to our range, both on and off the bike. Made from 6oz waterproof coated nylon, our musettes are durable and reliable. A popper fastener keeps everything secure, whilst an adjustable Hypalon shoulder strap tailors the bag to any user.

Included on the inside of the bag is an elastic loop, allowing the bag to be packed down and folded to a minute size, allowing it to fit into a jersey pocket or any other luggage with ease.

## TECHNICAL DETAILS

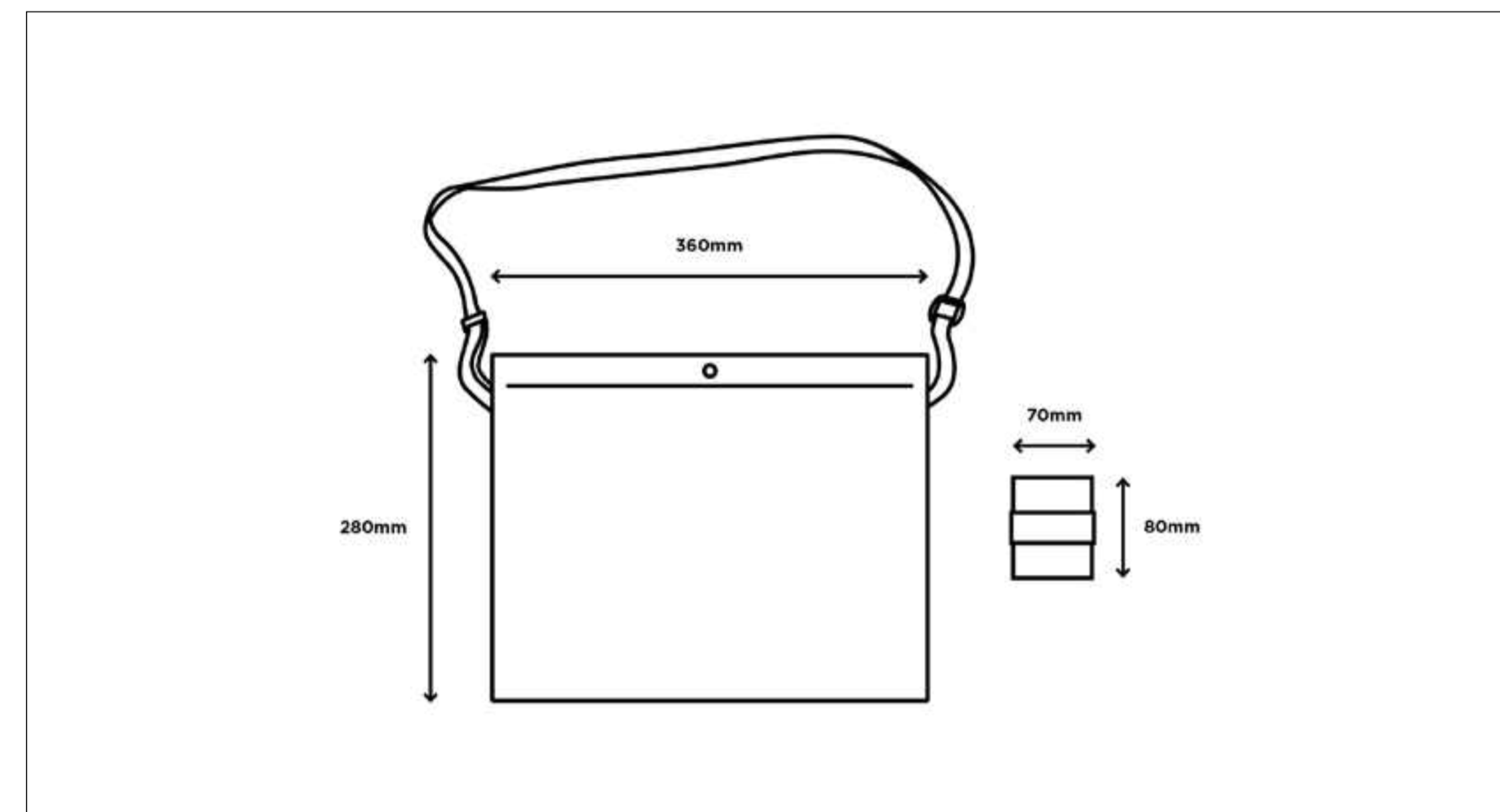

Materials	<b>Body:</b> 210 Denier Nylon <b>Webbing:</b> Hypalon
Size	<b>3L Unpacked:</b> 36cm wide x 17cm height <b>3L Packed:</b> 7cm wide x 7cm height
Weight	70g
Product Codes	<b>Black</b> - RS_RMU_STD_BLK <b>Olive</b> - RS_RMU_STD_OLV <b>Orange</b> - RS_RMU_STD_ORA
HS Code	42029211

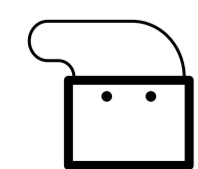
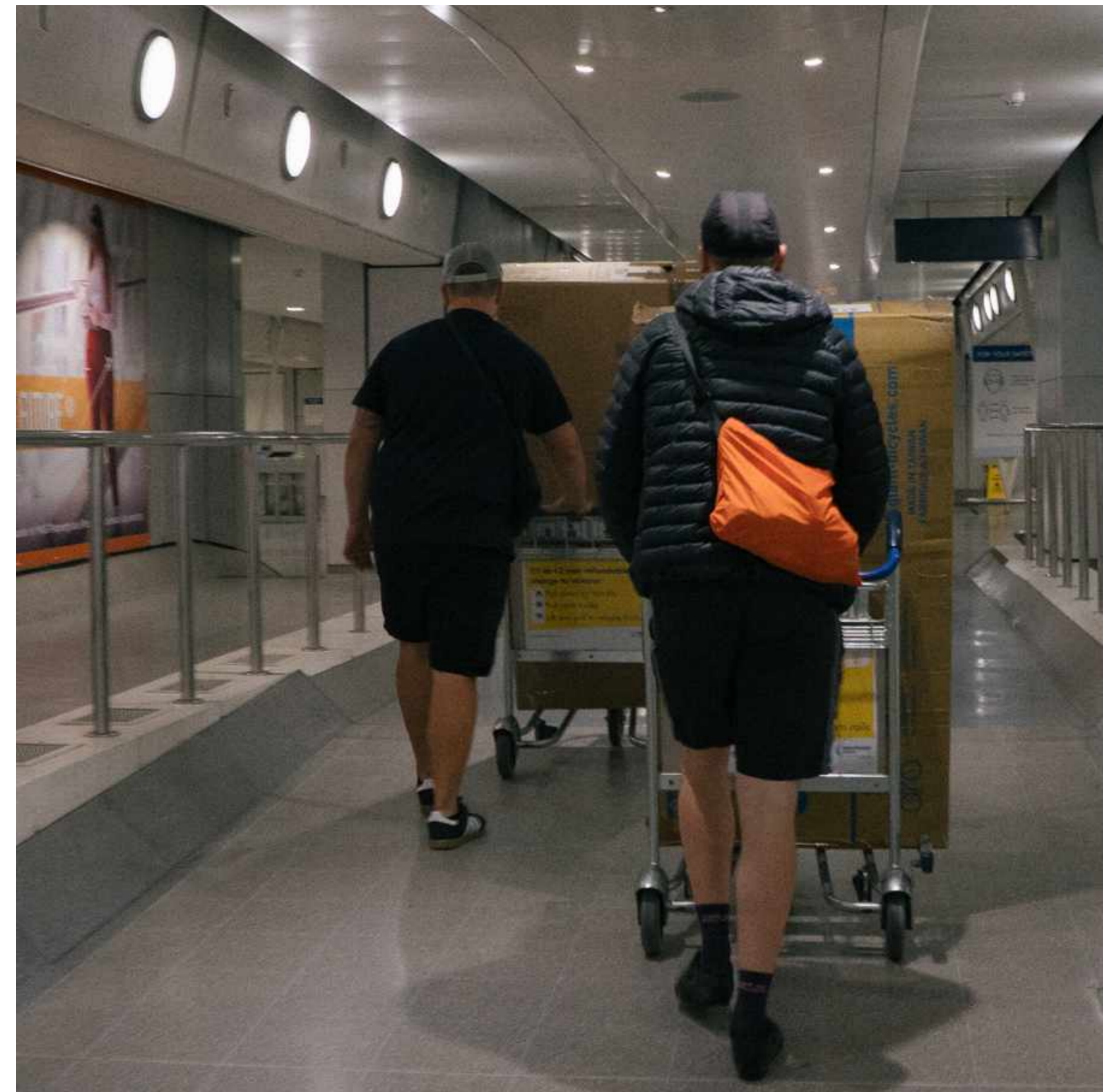

ON-BODY BAGS



HANDMADE IN UK



LIFETIME WARRANTY



## RACE DRY BAG - 7 LITRES

Page 14

Our handmade dry bags feature tape-sealed seams to make them 100% waterproof, keeping all your belongings dry within our holsters, in bags or simply by themselves. The 7 Litre Race Dry Bag is made from 6oz waterproof coated nylon. It is designed to work seamlessly with the Race Saddle Bag and Race Aero Bar Bag and includes reflective detailing to aid visibility during night time riding.

## RACE DRY PACK - 7 LITRES

Our handmade dry bags feature tape-sealed seams to make them 100% waterproof, keeping all your belongings dry within our holsters, in bags or simply by themselves.

The 7 Litre Race Dry Pack is made from 6oz waterproof coated nylon. It is designed to work seamlessly with the Race Bar Bag and includes reflective detailing to aid visibility during night time riding, a single roll-top closure and mesh side pockets for easy access on the move.

## TECHNICAL DETAILS

<b>RACE DRY BAG - 7 LITRES</b>	
Materials	<b>Body:</b> Nylon <b>Webbing:</b> Nylon <b>Pockets:</b> Mesh
Size	<b>7L Race Dry Bag</b> - W330mm x D150mm <b>7 L Race Dry Pack</b> - W280mm x D180mm
Weight	<b>7L Race Dry Bag</b> - 58g <b>7L Race Dry Pack</b> - 106g
Product Codes	<b>7L Race Dry Bag</b> - RS_RDB_07L_BLK <b>7L Race Dry Pack</b> - RS_RDP_07L_BLK
HS Code	42029211

## RACE DRY BAG - 7 LITRES



## RACE DRY PACK - 7 LITRES



ALL BAGS



A white mountain bike is parked on a sandy beach, leaning against a large piece of driftwood. The bike is equipped with black tires, a black seat, and several black gear bags with orange accents. The background shows a beach with sand dunes and a cloudy sky. The text "CARRY EVERYTHING RANGE" is overlaid in white, bold, sans-serif font across the center of the image.

**CARRY EVERYTHING RANGE**



## BAR BAG - SMALL

Page 16

Our Bar Bag is an ideal and hassle free luggage solution for bikepacking, touring or commuting on road, gravel and mountain bikes. With no rack, mounts or tools required, the bag attaches to any bike in seconds. Foam spacers and spring-loaded cam locks provide an easy and reliable attachment to your handlebars, whilst two lower retention straps wrap around the crown of the fork for added stability.

The 14L Double Roll Dry Bag is made of tape-sealed and waterproof coated 6oz nylon and elasticated shock cord on the front of the holster provides additional accessible storage for jackets, gloves and other accessories. The tough textured nylon holster and robust webbing straps mean that our Bar Bags can be depended on, no matter how demanding the terrain you're traversing.

Handmade in our Yorkshire workshop and finished with the classic vegan-friendly PU leather Restrap label.

Weight - 370g  
Capacity - 14L

(Dry bag included)

## TECHNICAL DETAILS

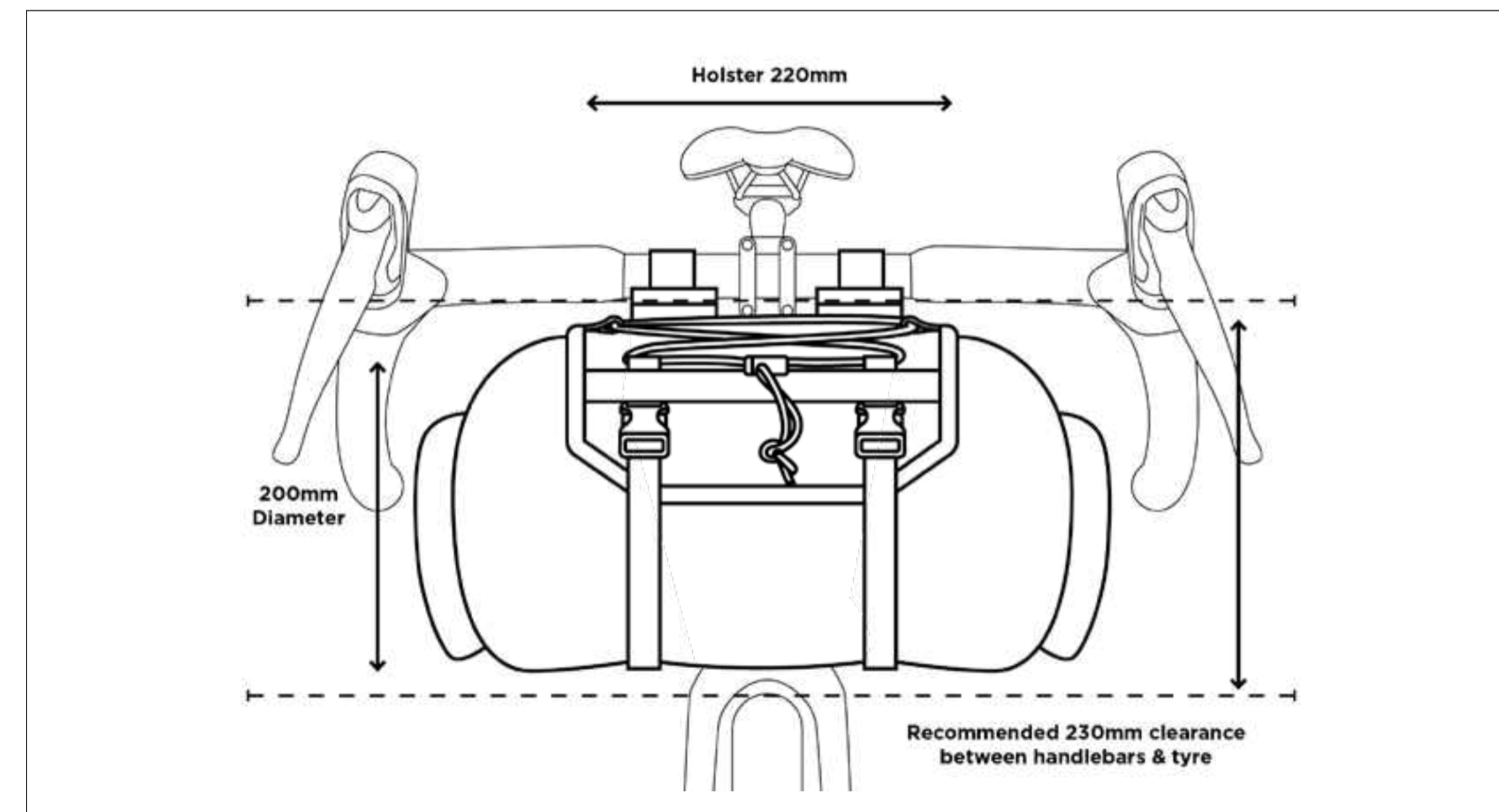

Materials	<b>Body:</b> 1000D Textured Nylon <b>Lining:</b> PU Coated Nylon <b>Webbing:</b> Nylon <b>Storage:</b> Shock Cord
Size	<b>Small Bar Bag</b> - W220mm x D200mm <b>14L Double Roll Dry Bag</b> - D180mm x L560mm
Weight	<b>Bar Bag - Small</b> - 370g
Product Codes	<b>Orange</b> - RS_BB2_STD_ORA <b>Black</b> - RS_BB2_STD_BLK
HS Code	42029211



Small Bar Bag with Orange Paracord



Small Bar Bag with Black Paracord



HANDLEBAR BAGS

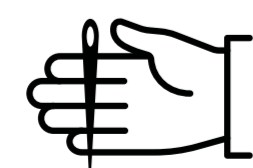

HANDMADE IN UK



LIFETIME WARRANTY



## BAR BAG - LARGE

Page 17

Our Bar Bag is an ideal and hassle free luggage solution for bikepacking, touring or commuting on road, gravel and mountain bikes. With no rack, mounts or tools required, the bag attaches to any bike in seconds. Foam spacers and spring-loaded cam locks provide an easy and reliable attachment to your handlebars, whilst two lower retention straps wrap around the crown of the fork for added stability.

The 14L Double Roll Dry Bag is made of tape-sealed and waterproof coated 6oz nylon and a 3L food pouch attaches to the front of the holster via two magnetic fittings, providing accessible and convenient storage for food, tools, layers and other accessories. The tough textured nylon holster and robust webbing straps mean that our Bar Bags can be depended on, no matter how demanding the terrain you're traversing.

Handmade in our Yorkshire workshop and finished with the classic vegan-friendly PU leather Restrap label.

Weight - 560g  
Capacity - 17L

(Dry bag and food pouch included)

### TECHNICAL DETAILS

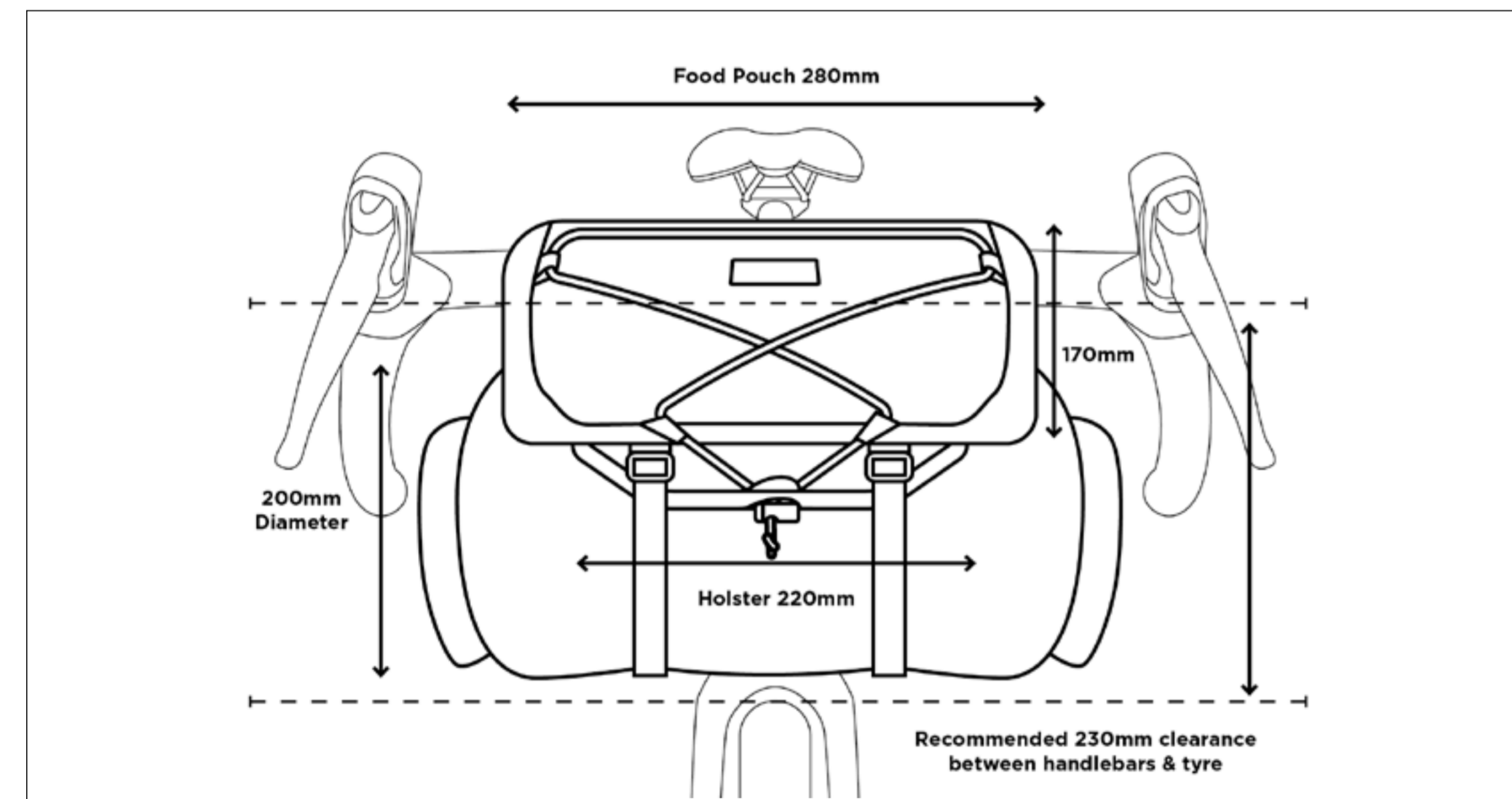

Materials	<b>Body:</b> 1000D Textured Nylon <b>Lining:</b> PU Coated Nylon <b>Webbing:</b> Nylon <b>Zipper:</b> YKK <b>Includes Fidlock Fittings</b>
Size	<b>Large Bar Bag</b> - W280mm x D200mm <b>Large Food Pouch</b> - W280mm x H170mm <b>14L Double Roll Dry Bag</b> - D18cm x L56cm
Weight	<b>Bar Bag Large</b> - 560g
Product Codes	<b>Orange</b> - RS_BB7_STD_BLK <b>Black</b> - RS_BB1_LRG_BLK/BLK
HS Code	42029211

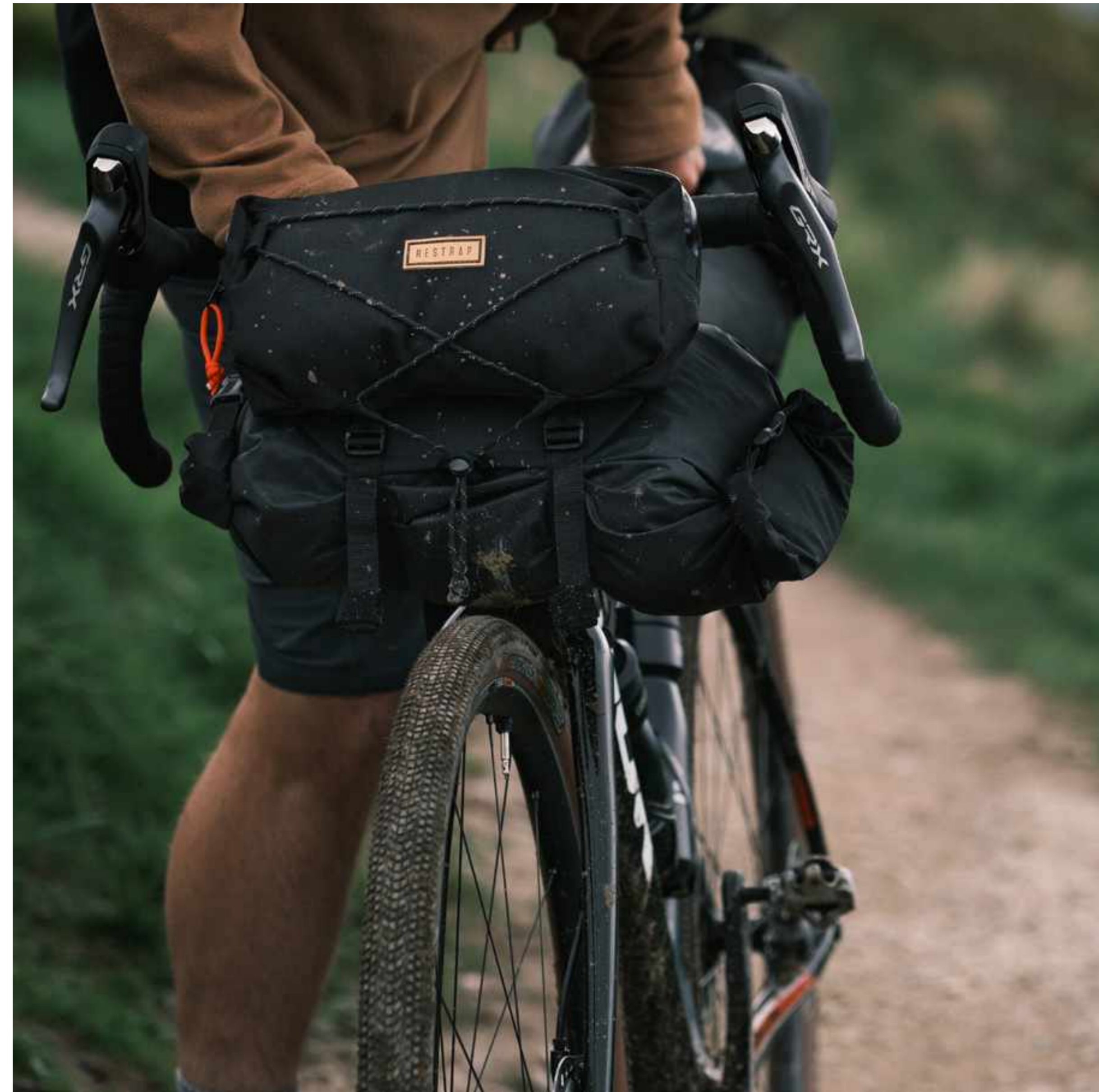

14L Bar Bag with Orange Paracord



17L Bar Bag with Black Paracord



14L Bar Bag with Orange Paracord



14L Bar Bag with Orange Paracord



Bar Bag Holster With Food Pouch Removed



HANDLEBAR BAGS

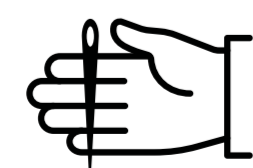

HANDMADE IN UK



LIFETIME WARRANTY



## BAR PACK

Page 18

Ideal for shop runs, off road adventures or audaxes, the Bar Pack is the perfect all day companion. Two fully waterproof roll top compartments provide 10 litres of capacity with a hypalon closure, securing the front compartment and providing a mounting slot for a clip-on front light or additional strapping. A mini D-lock holster sits between the two compartments, with the front compartment closure doubling as a securing strap for a lock for any urban excursions.

Structural rigidity is provided by an internal stiffener, a compact pack is guaranteed at all times due to the side-release tension and buckle system. An additional hard shell back provides further rigidity and a MOLLE adjustable headtube retention system guarantees a secure fit to your bike.

Foam spacers and spring-loaded cam locks provide a stable and reliable attachment to your handlebars. An elasticated drawcord provides perfect on-the go storage for gloves, jackets and other accessories.

## TECHNICAL DETAILS

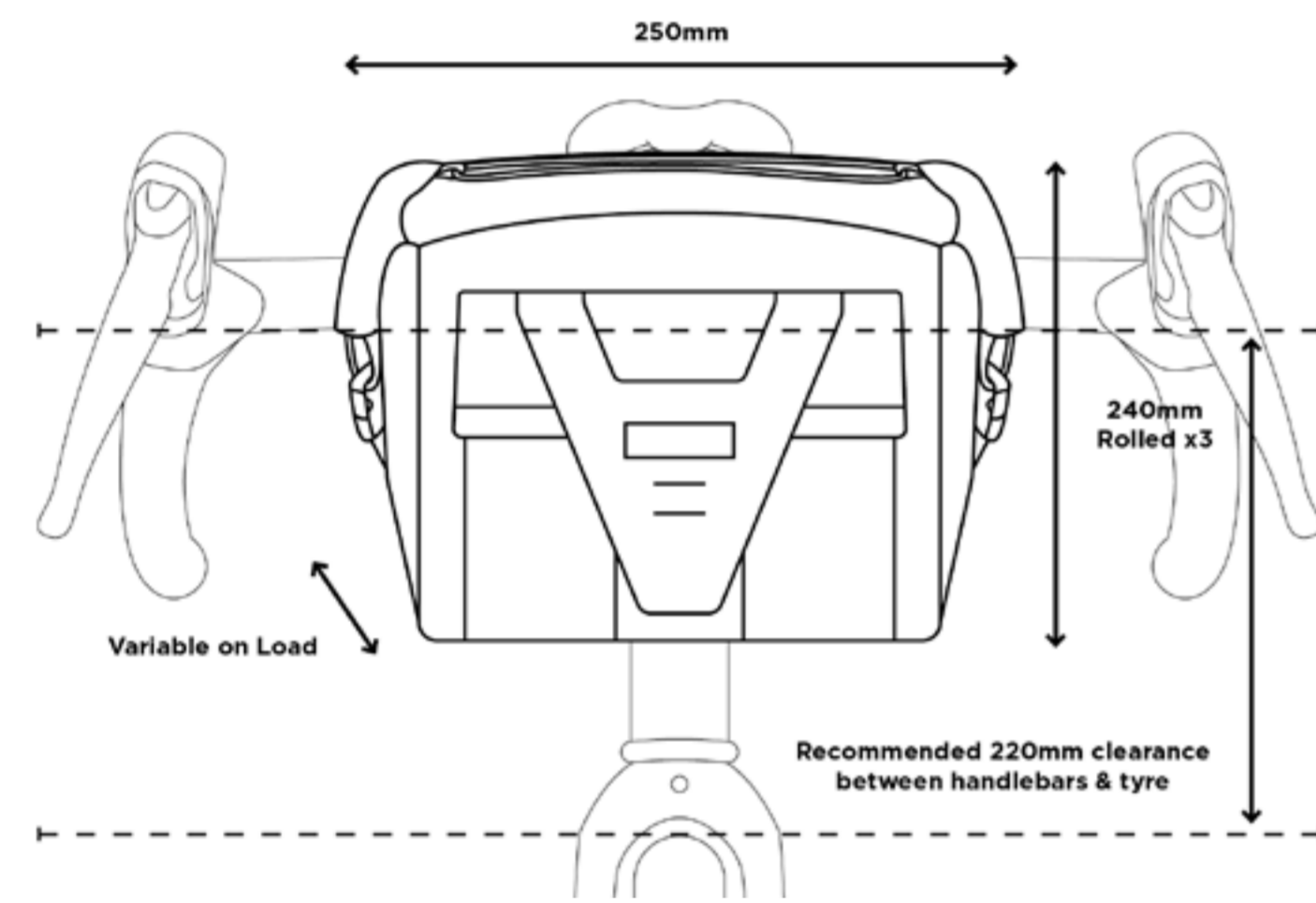

Materials	<b>Body:</b> 1000D Textured Nylon <b>Lining:</b> PU Coated Nylon <b>Webbing:</b> Nylon <b>Drawcord:</b> Reflective Shock Cord <b>Closure:</b> Hypalon
Size	<b>Bar Pack Rolled Down</b> - W29cm x H23cm x D16cm <b>Bar Pack Open</b> - W25cm x H37cm x D16cm
Weight	585g
Product Codes	<b>Black</b> - RS_HBP_STD_BLK <b>Orange</b> - RS_HBP_STD_ORA <b>Olive</b> - RS_HBP_STD_OLV
HS Code	42029211



Bar Pack - Black



Bar Pack - Orange (Mini D-Lock being inserted into holster)



Bar Pack - Black (Elasticated Drawcord in use)



Bar Pack - Olive



Bar Pack - Olive (Mini D-Lock secured in holster)



HANDLEBAR BAGS

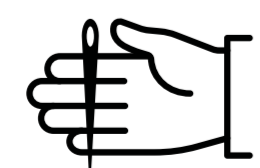

HANDMADE IN UK



LIFETIME WARRANTY



## CANISTER BAG

Page 19

1.5L Canister Bag

Made from textured nylon and with a top YKK zip, the spacious yet compact bag is the ideal accompaniment for day rides. Elasticated side pockets and the unique canister shape mean you'll easily have room for tools, tubes and extra clothes. The Canister Bag features a rear shock cord retention strap along with a loop to attach a front light, which is perfect for early starts or late finishes.

Handmade in our Yorkshire workshop from 100% waterproof textured nylon, with a nylon lining and finished with the classic vegan-friendly PU leather Restrap label.

Weight - 120g  
Capacity - 1.5L

### TECHNICAL DETAILS

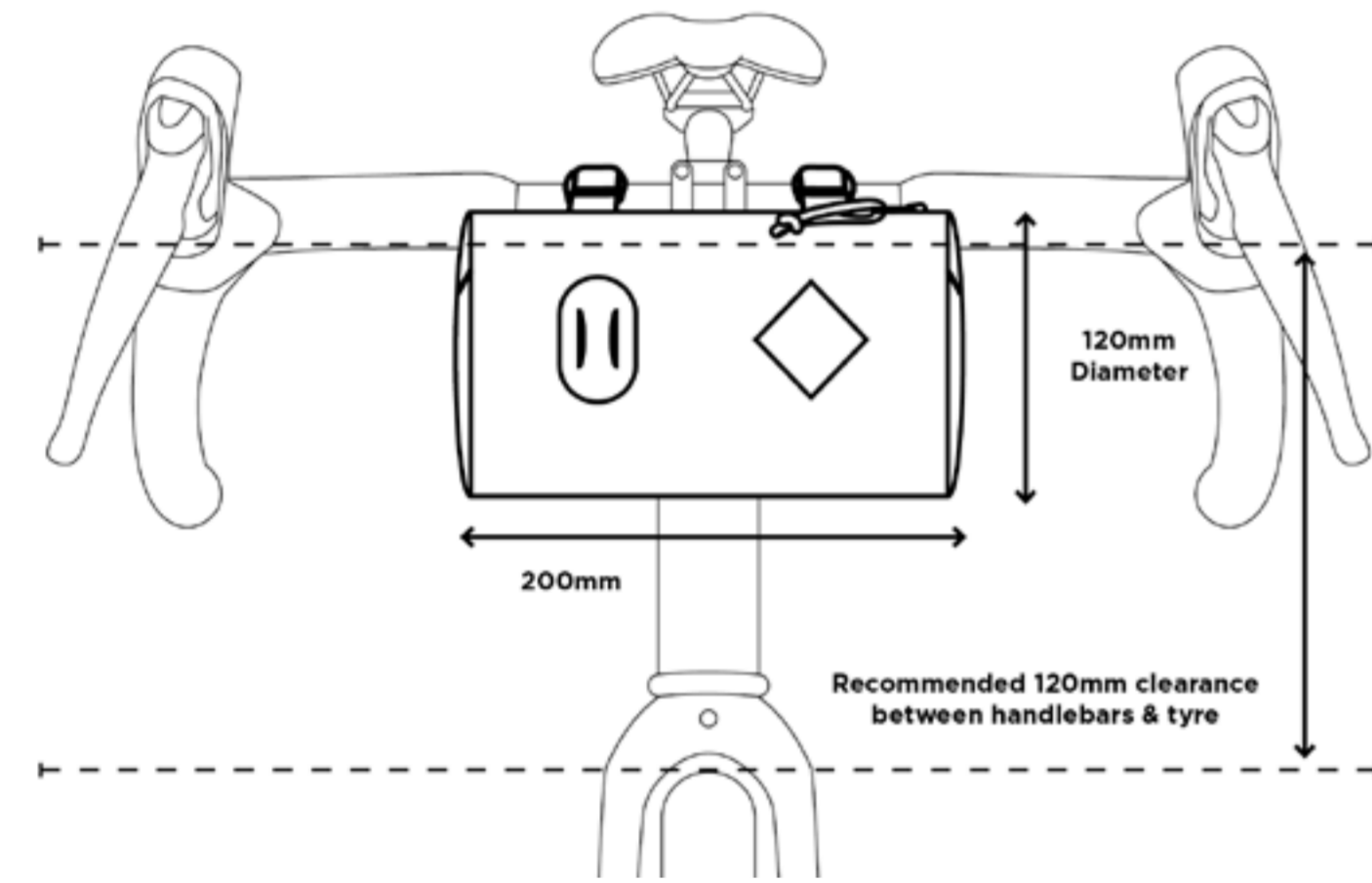

Materials	<b>Body:</b> 1000D Textured Nylon <b>Lining:</b> PU Coated Nylon <b>Webbing:</b> Nylon <b>Zipper:</b> YKK
Size	1.5 litres - 20cm length x 12cm diameter
Weight	120g
Product Codes	<b>BLACK</b> SKU - RS_SCB_STD_BLK <b>OLIVE</b> SKU - RS_SCB_STD_OLV <b>ORANGE</b> SKU - RS_SCB_STD_ORA
HS Code	42029211



HANDLEBAR BAGS

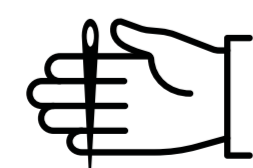

HANDMADE IN UK



LIFETIME WARRANTY



## SADDLE BAG

Page 20

Made from 1000D textured nylon and with a top YKK zip, the spacious, yet compact bag is the ideal accompaniment for day rides. Elasticated side pockets and the unique canister shape mean you'll easily have room for tools, technology and extra clothes.

For early mornings or later evenings, the Canister Bag also has a loop to attach a front light.  
\*We do not recommend using this product on Aero Carbon seat posts.

### TECHNICAL DETAILS

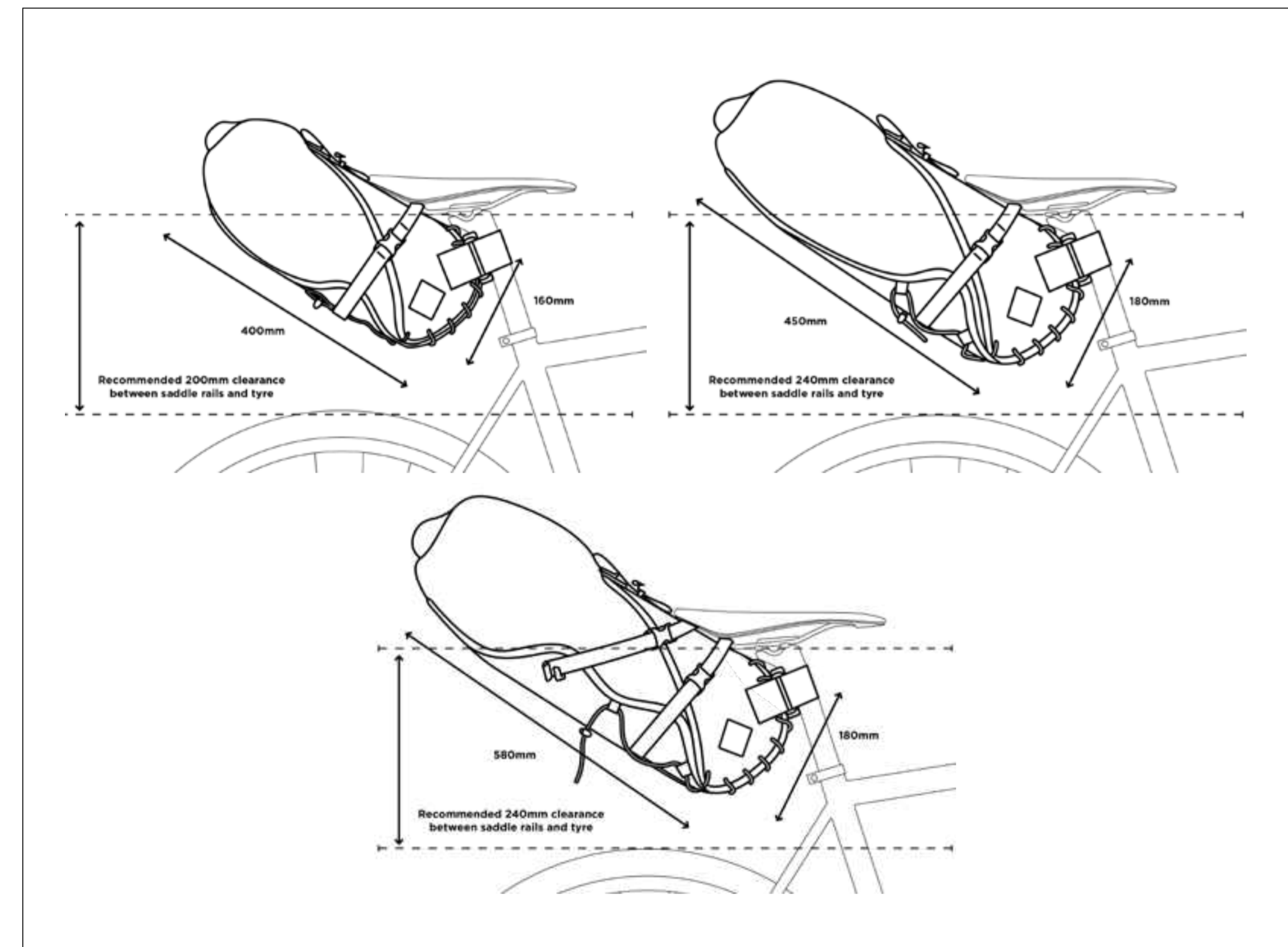

Materials	<b>Body:</b> 1000D Textured Nylon <b>Lining:</b> PU Coated Nylon <b>Webbing:</b> Nylon <b>Zipper:</b> YKK <b>Includes Fidlock Fittings</b>
Size	<b>8L</b> - H46cm x D15cm <b>14L</b> - H56cm x D18cm <b>18L</b> - H58cm x D18cm
Weight	<b>8L</b> - 427g <b>14L</b> - 535g <b>18L</b> - 645g
Product Codes	<b>8L Black</b> - RS_SB1_SML_BLK <b>8L Orange</b> - RS_SB1_SML_ORG <b>14L Black</b> - RS_SB1_LRG_BLK <b>14L Orange</b> - RS_SB1_LRG_ORG <b>18L Black</b> - RS_SB1_XLG_BLK <b>18L Orange</b> - RS_SB1_XLG_ORG
HS Code	42029211

8L Saddle Bag - Black



14L Saddle Bag - Orange



18L Saddle Bag - Black



SADDLE BAGS

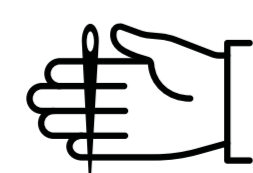

HANDMADE IN UK



LIFETIME WARRANTY



## SADDLE PACK

Page 21

4.5L Saddle Pack

Part of the carryeverything range, our rack-less saddle pack connects securely to your seat post for bike packing, touring or commuting. With no mounts or screws, the bag attaches in seconds to any bike. Our super lightweight 4.5-litre waterproof saddle pack is made from 1000D Textured Nylon. Nylon-lined and with taped seams, it has a roll top closure, offering tough protection against the elements.

It's secure fitting and unique magnetic compression strap mean it's easy to fit. Large enough for tools, a jacket and food, it's perfect for day rides or lightweight bike packing.

## TECHNICAL DETAILS

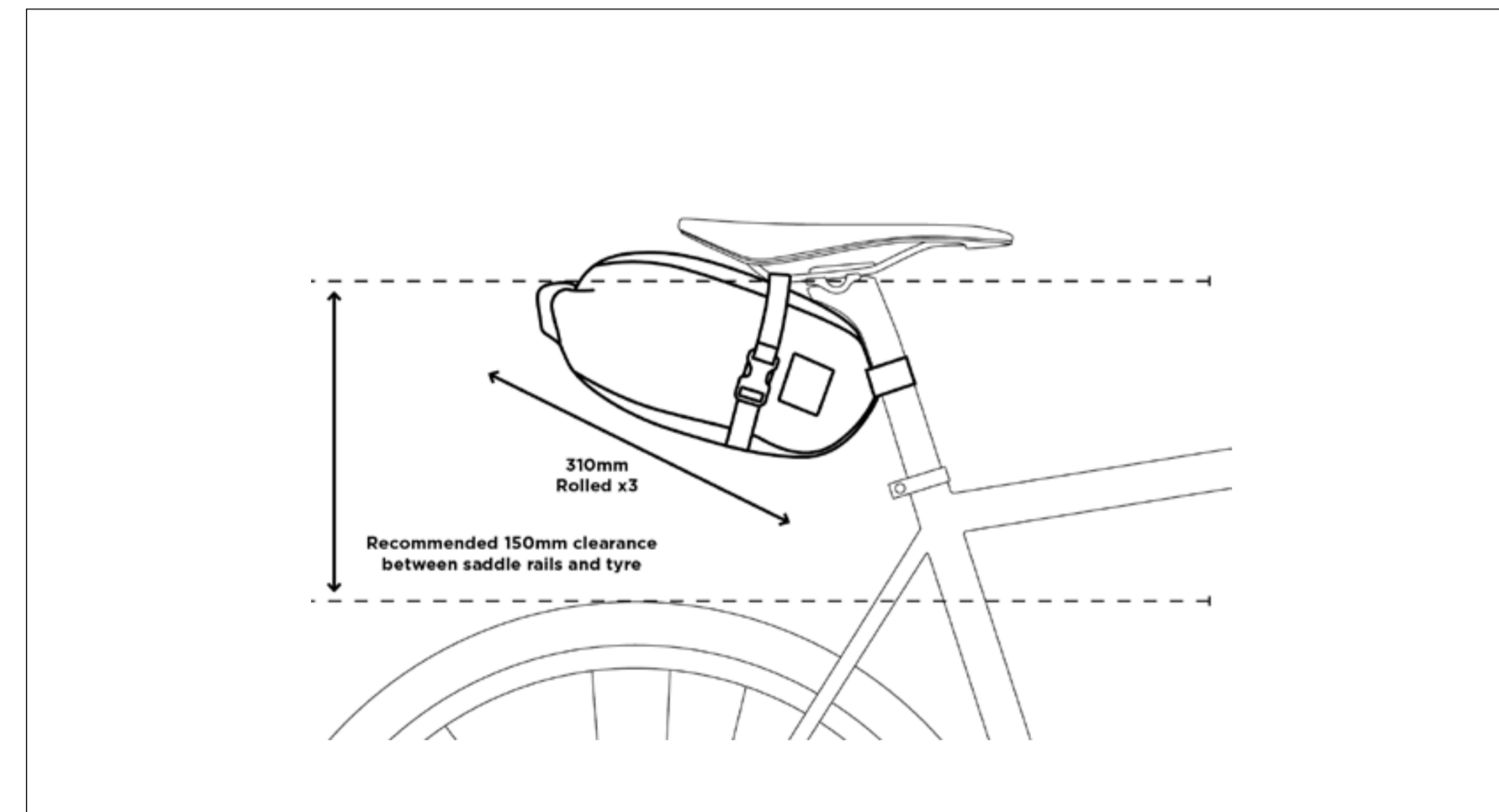

Materials	<b>Body:</b> 1000D Textured Nylon <b>Lining:</b> PU Coated Nylon <b>Webbing:</b> Nylon <b>Zipper:</b> YKK <b>Includes Fidlock Fittings</b>
Size	<b>4.5L</b> - L31cm x W13cm x D7-15cm Tapered
Weight	<b>4.5L</b> - 200g
Product Codes	<b>Black</b> - RS_SB3_SML_BLK
HS Code	42029211



SADDLE BAGS

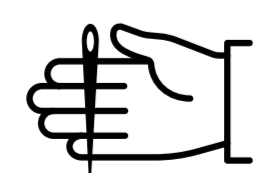

HANDMADE IN UK



LIFETIME WARRANTY



## TOOL POUCH

Page 22

4.5L Saddle Pack

The Tool Pouch is ideal for carrying tubes, tools and spares during all kinds of riding, from road rides to mountain biking.

Made with hardwearing 1000D textured nylon and a nylon lining, this pouch is tough against grit and grime. The foam cushioning helps protect your tools and an internal storage sleeve is perfect for smaller items.

The adjustable velcro flap ensures that the pouch fits well, whether it's packed to the brim or lightly loaded and includes reflective detailing to aid visibility during night-time riding.

Finished with the classic Restrap label, made from vegan-friendly PU.

## TECHNICAL DETAILS

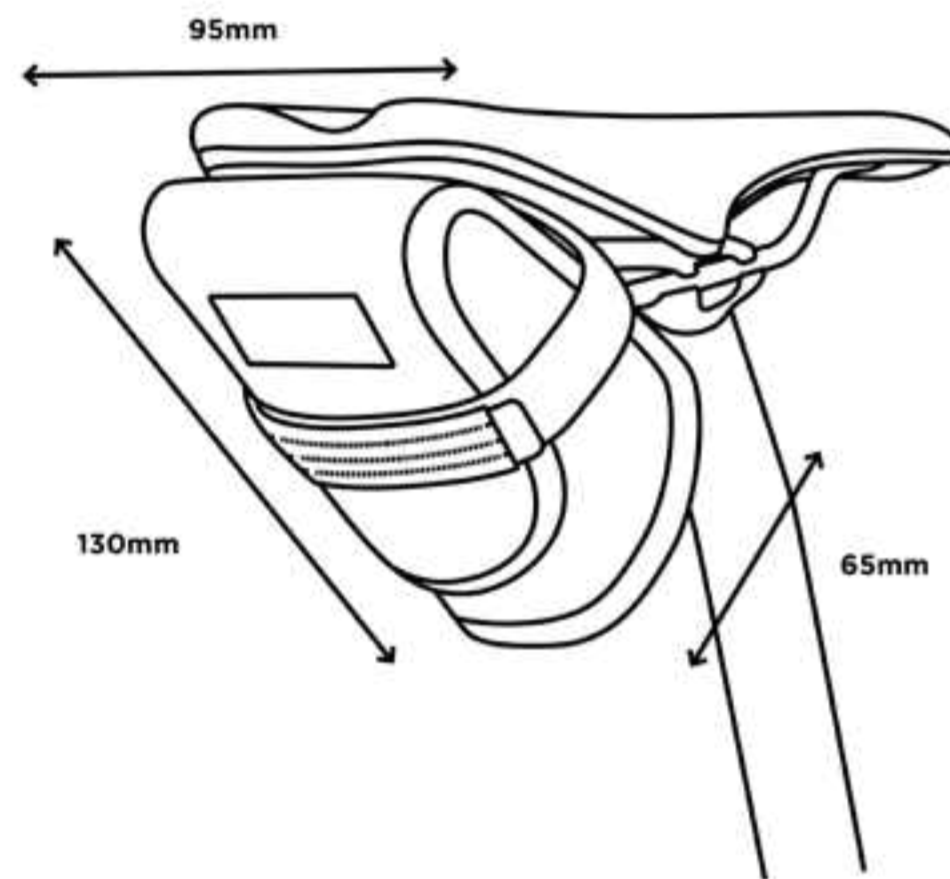

Materials	<b>Body:</b> 1000D Textured Nylon <b>Lining:</b> PU Coated Nylon <b>Webbing:</b> Reflective Velcro
Size	<b>0.6L</b> - 130mm x 95mm x 65mm
Weight	<b>0.6L</b> - 80g
Product Codes	<b>Black</b> - RS_TPC_STD_BLK <b>Olive</b> - RS_TPC_STD_OLV <b>Orange</b> - RS_TPC_STD_ORA
HS Code	42029211

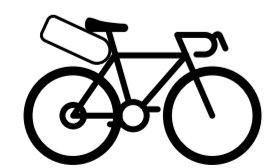

SADDLE BAGS

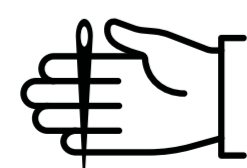

HANDMADE IN UK



LIFETIME WARRANTY



## FRAME BAG

Page 23

The #carryeverything frame bags allow you to easily increase the load you carry for comfortable bike packing and touring. With no mounts or screws, the bags come in three different sizes to suit any frame. With YKK zips, a fully waterproof 1000D cordura outer and VX21 fabrics, our Frame Bags are tough, durable and versatile.

Rubberised strapping provides extra grip to the frame and reflective paracord zip pulls give additional security. Inner mesh pockets keep you organised whilst on the road and the medium and large bags contain an additional document pocket. An extra cable slot is provided for dynamo cabling.

## TECHNICAL DETAILS

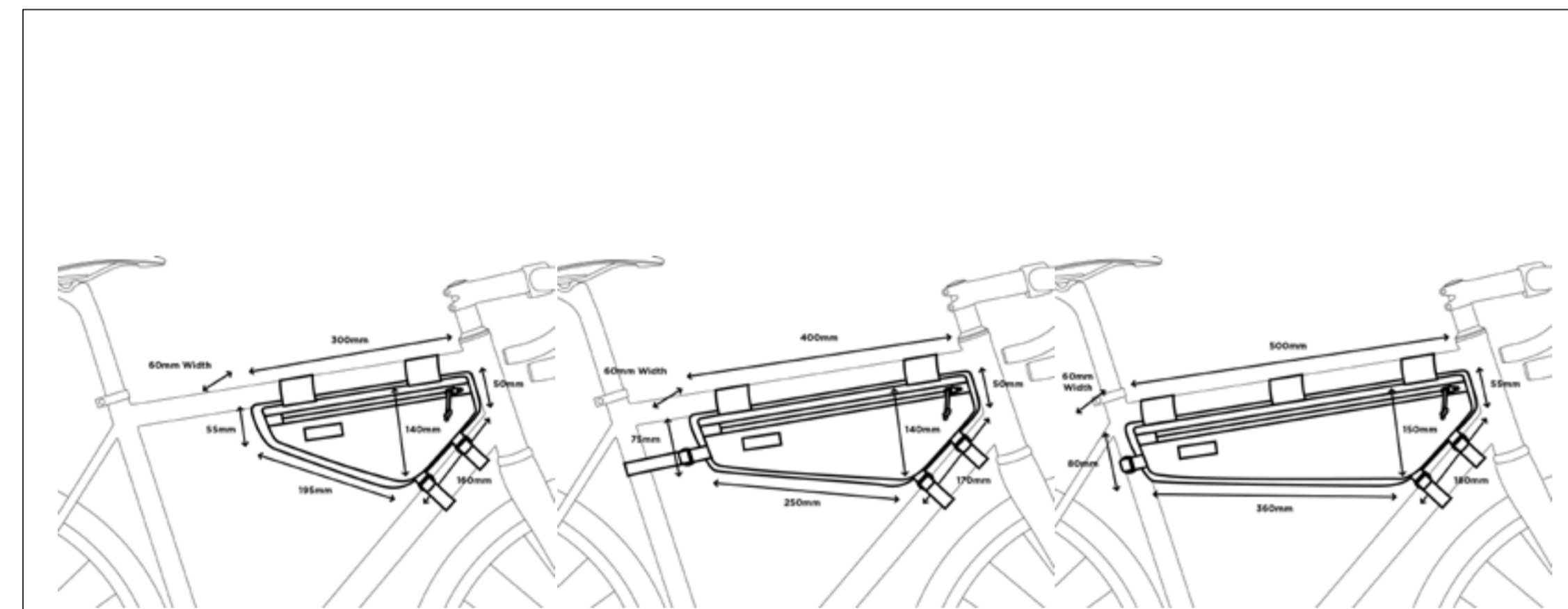

Materials	<b>Body:</b> 1000D Textured Nylon & VX21 <b>Lining:</b> PU Coated Nylon <b>Webbing:</b> Nylon <b>Zipper:</b> YKK
Size	<b>Small:</b> 2.5L - L30cm x H15cm x D6cm <b>Medium:</b> 3.5L - L40cm x H15cm x D6cm <b>Large:</b> 4.5L - L50cm x H15cm x D6cm
Weight	<b>Small</b> - 150g <b>Medium</b> - 190g <b>Large</b> - 240g
Product Codes	<b>Small</b> - RS_FBG_SML_BLK <b>Medium</b> - RS_FBG_MED_BLK <b>Large</b> - RS_FBG_LRG_BLK
HS Code	42029211



Small Frame Bag



Medium Frame Bag

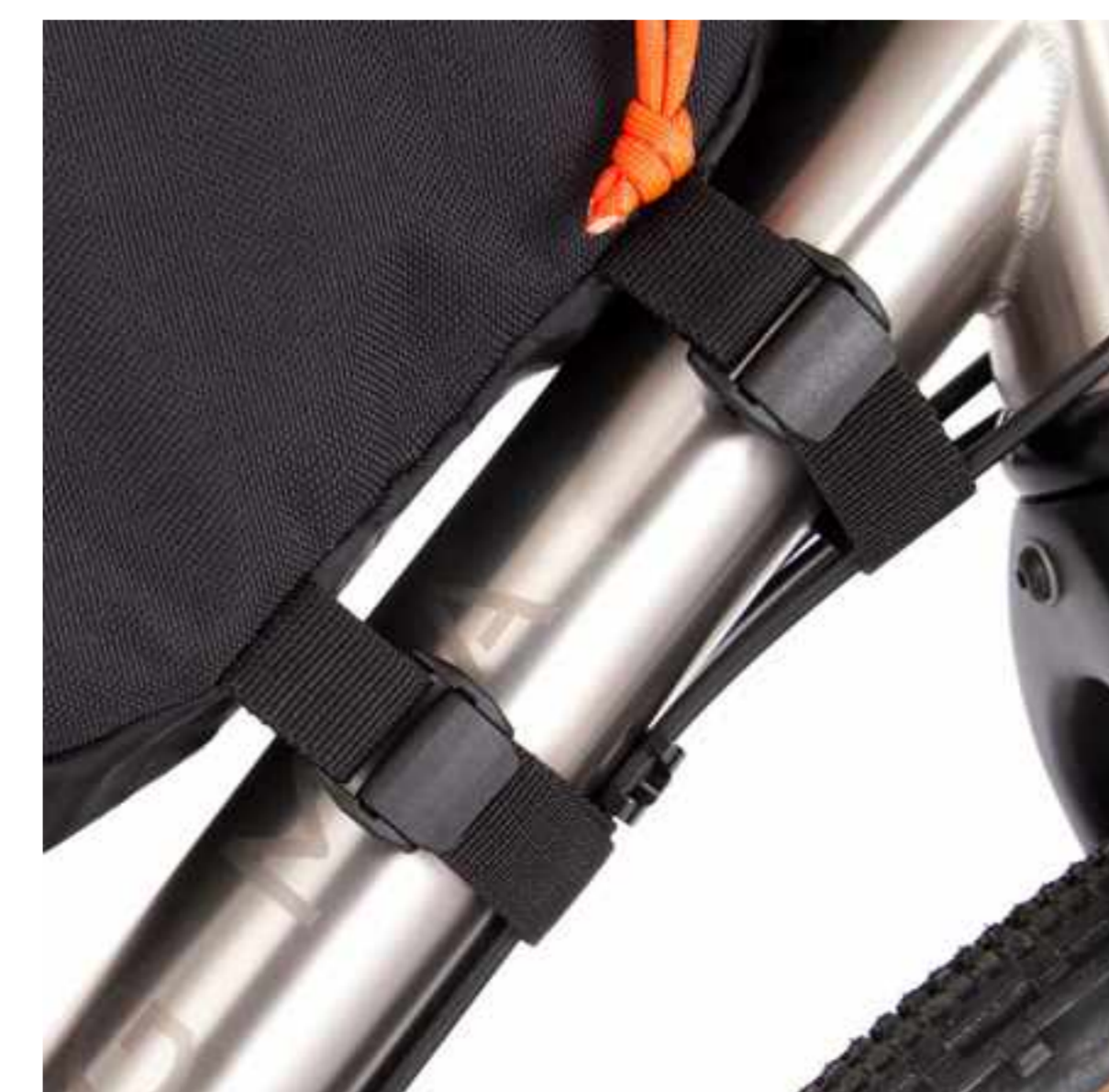

Large Frame Bag



FRAME BAGS

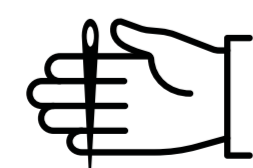

HANDMADE IN UK



LIFETIME WARRANTY



## FULL FRAME BAG

Page 24

The Restrap Full Frame Bag allows you to easily increase the load out you carry for comfortable bikepacking and touring. The bags come in three sizes, designed to fit most standard frames and geometries.

Two Aquaguard YKK zips on the drive side of the bag allow easy access to the top and bottom sections of the bag, with internal velcro dividers to separate the compartments. These dividers aid the structure of the bag when fully packed, but also fold away to allow use of the full internal space of the bag if needed. The non-drive-side of the bag contains a document pocket, useful for storing smaller items.

The bag is made from durable, textured nylon outer and VX21 fabrics, with a wipeable lower section that means the bag is easy to keep clean when riding off-road or in adverse weather. Rubberised strapping provides extra grip to the frame and webbing straps, with easy-to-use cam locking buckles, keep the bag sitting securely and free of movement while riding.

Hand made in our Yorkshire workshop, all bags are finished with the classic Restrap label, made from vegan-friendly PU.

## TECHNICAL DETAILS

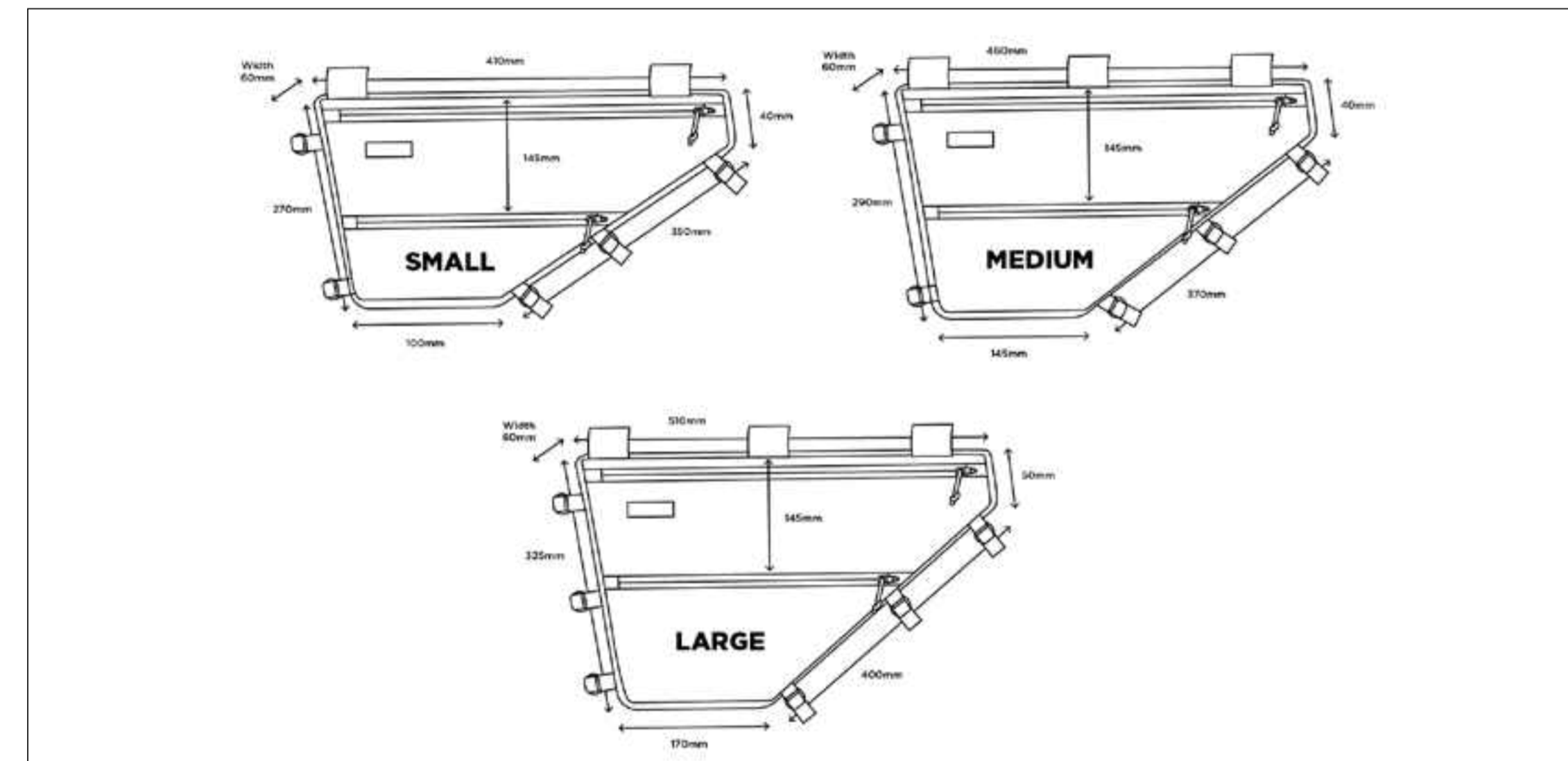

Materials	<b>Body:</b> 1000D Textured Nylon & VX21 <b>Lining:</b> PU Coated Nylon <b>Webbing:</b> Nylon <b>Zipper:</b> YKK
Size	<b>Small:</b> 6L - 410mm x 270mm x 60mm <b>Medium:</b> 7.5L - 460mm x 290mm x 60mm <b>Large:</b> 9L - 510mm x 325mm x 60mm
Weight	<b>Small</b> - 266g <b>Medium</b> - 320g <b>Large</b> - 365g
Product Codes	<b>Small</b> - RS_FFB_SML_BLK <b>Medium</b> - RS_FFB_MED_BLK <b>Large</b> - RS_FFB_LRG_BLK
HS Code	42029211

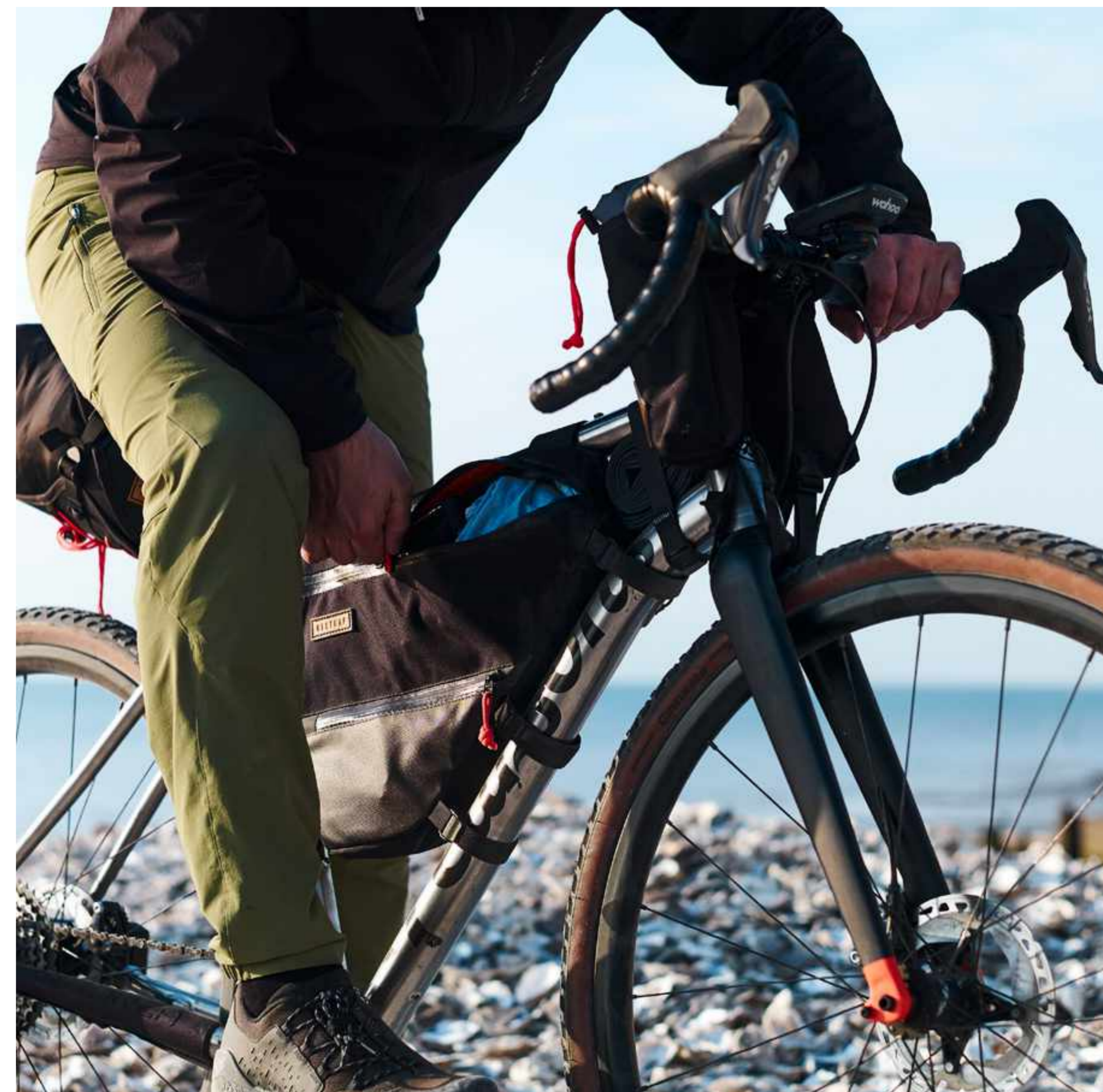

FRAME BAGS

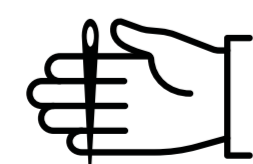

HANDMADE IN UK



LIFETIME WARRANTY



## TOP TUBE BAG

Page 25

Whether you're out for an hour, commuting, or on a multi-day tour, the Restrap Top Tube Bag is perfectly designed to keep your tools and snacks within reach. Made from 100% waterproof 1000D cordura, and with a YKK zip, it will withstand whatever your ride throws at it. The headset fitting is designed to work with all headsets, including bikes with a low stack height.

The Standard version of the Top Tube Bag has a rubberised velcro strap for the top-tube, whilst the Bolt-on version contains a sturdy plastic base has reinforced holes to allow it to fix onto the top tube bolt bosses, eliminating the need for straps and keeping the bag secure. The headset fitting is designed to work with all headsets, including bikes with a low stack height.

## TECHNICAL DETAILS

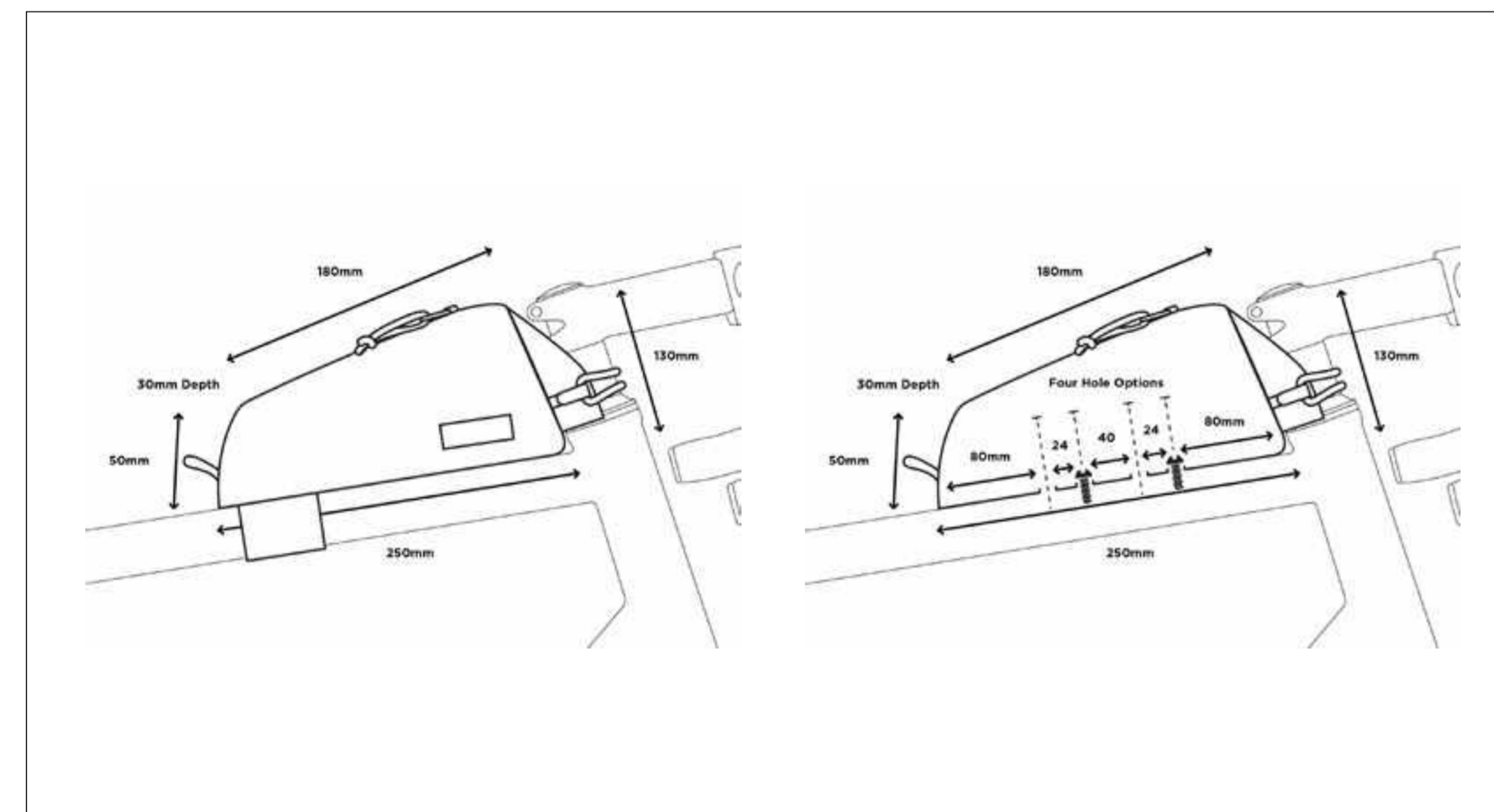

Materials	<b>Body:</b> 1000D Textured Nylon <b>Lining:</b> PU Coated Nylon <b>Webbing:</b> Nylon <b>Zipper:</b> YKK
Size	<b>0.8 litres</b> - L220mm x H130mm x W30mm
Weight	90g
Product Codes	<b>Standard Top Tube Bag</b> - RS_TTP_STD_BLK <b>Bolt-on Top Tube Bag</b> - RS_TTP_BOB_BLK
HS Code	42029211



Standard Top Tube Bag



Bolt-On Top Tube Bag



Standard Top Tube Bag



Bolt-On Top Tube Bag



COCKPIT BAGS

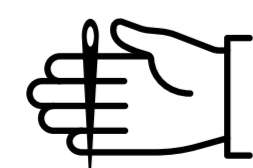

HANDMADE IN UK



LIFETIME WARRANTY



## REAR TOP TUBE BAG

Page 26

The Rear Top Tube Bag is the perfect add-on to maximise storage on your bike when frame space is limited, all other attachment points have been used or you want to organise tools, spares, food or other accessories into a separate compartment.

A simple zip closure allows for easy one-handed access. Hypalon MOLLE accents on the base and rear of the bag each provide two placements for the double sided velcro straps, allowing you to tailor the bag to be ideal for your set up.

Handmade in our Yorkshire workshop from 100% waterproof textured nylon, with a nylon lining and finished with the classic vegan-friendly PU leather Restrap label.

Weight - 70g  
Capacity - 1L

## TECHNICAL DETAILS

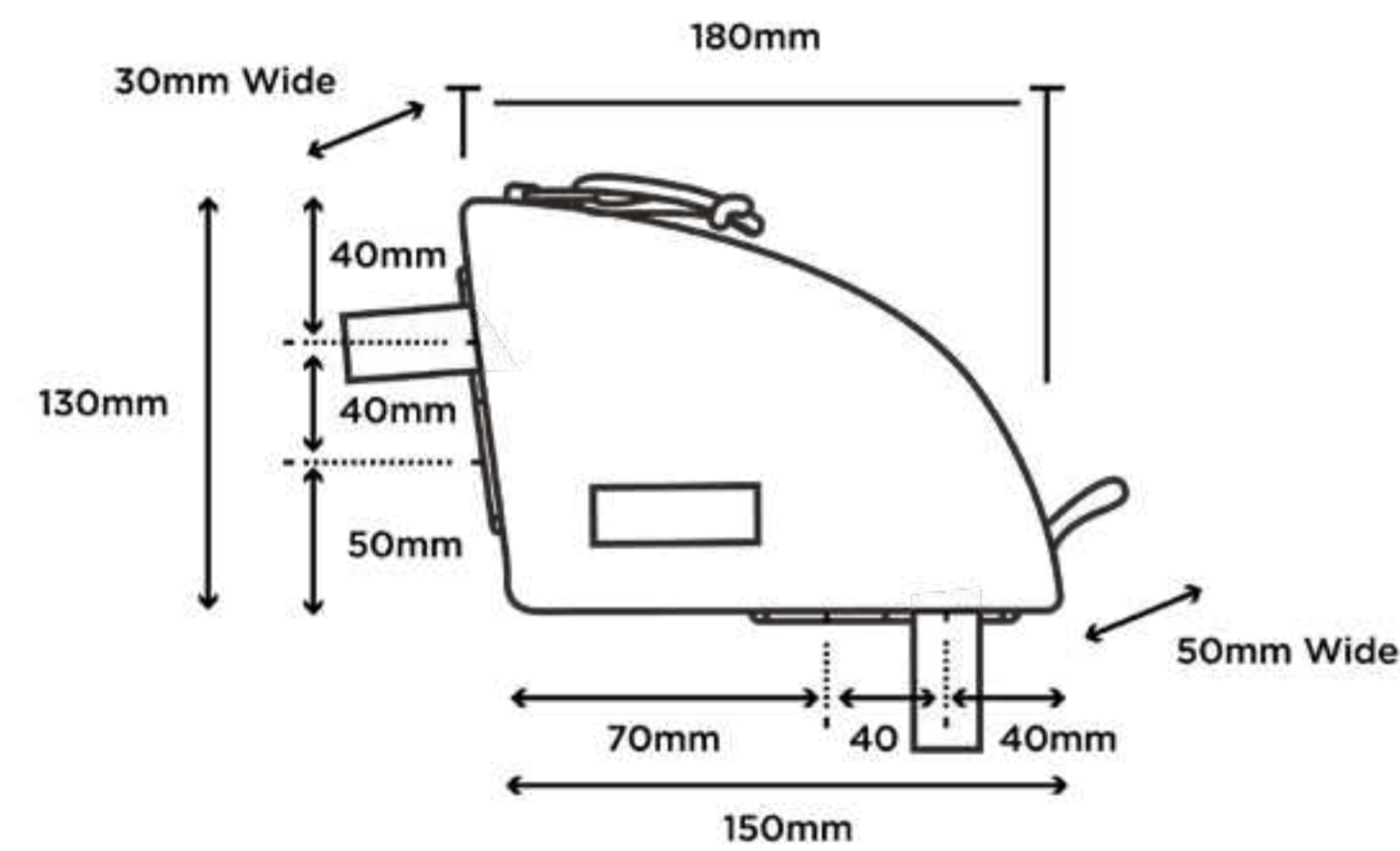

Materials	<b>Body:</b> 1000D Textured Nylon <b>Lining:</b> PU Coated Nylon <b>Webbing:</b> Velcro <b>Zipper:</b> YKK
Size	<b>1 litre</b> - L180mm x H130mm x W50-30mm
Weight	70g
Product Codes	<b>Rear Top Tube Bag</b> - RS_TTP RFC_BLK
HS Code	42029211



COCKPIT BAGS

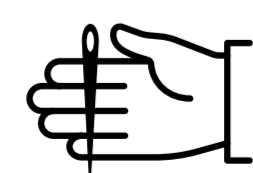

HANDMADE IN UK



LIFETIME WARRANTY





## STEM BAG

Page 27

The stem bag gives you even more storage. Part of our cockpit range, the stem bag is ideally designed for food or a water bottle, and will keep your supplies safe and dry.

Easy drawstring closure means you can access its contents on the go, whilst its adjustable Velcro and fork strap support fits any bike.

## TECHNICAL DETAILS

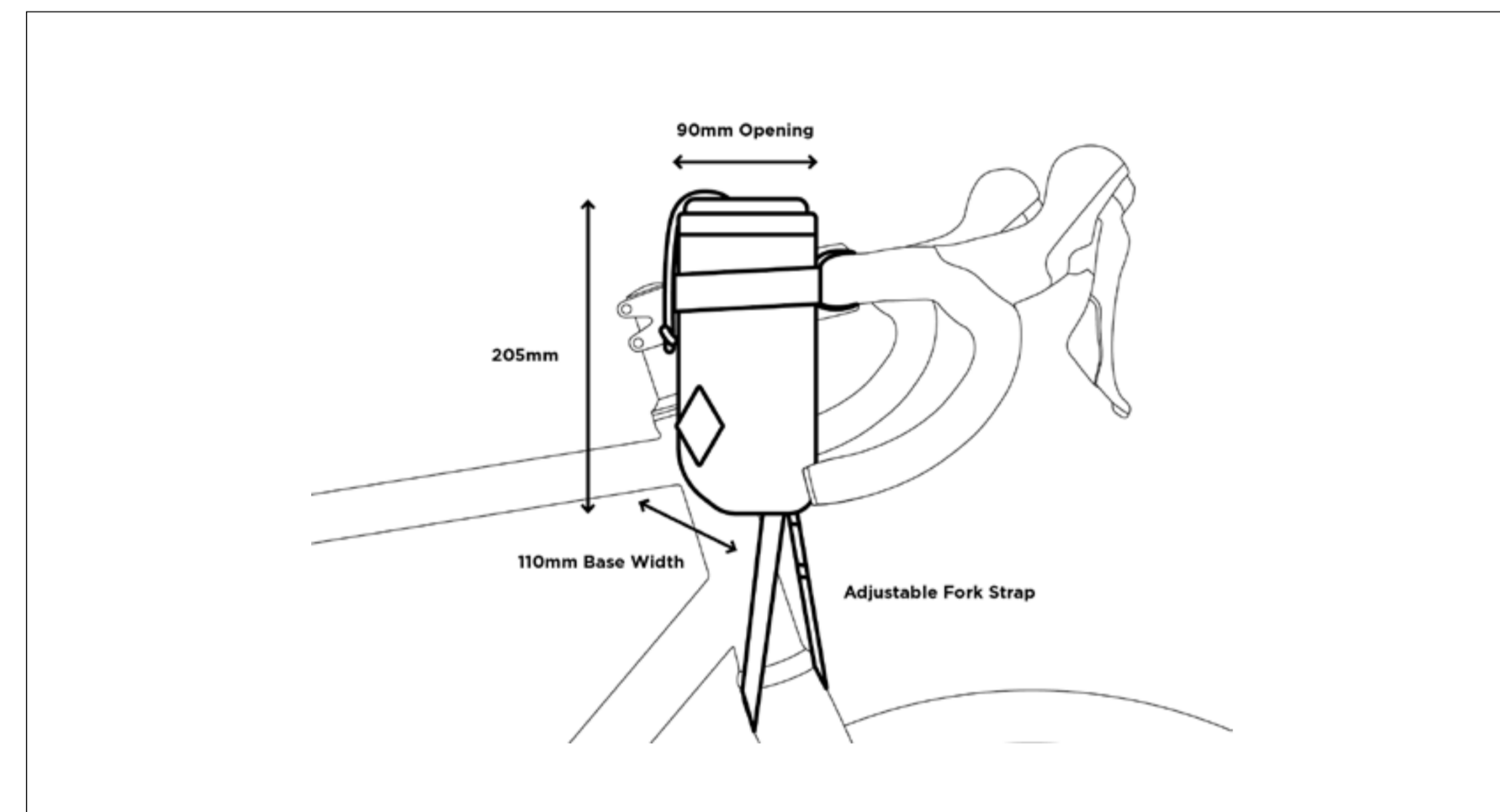

Materials	<b>Body:</b> 1000D Textured Nylon <b>Lining:</b> PU Coated Nylon <b>Webbing:</b> Nylon
Size	<b>1.1 litres</b> - H200mm x D80mm
Weight	90g
Product Codes	<b>Standard Top Tube Bag</b> - RS_STB_STD_BLK
HS Code	42029211

Stem Bag



COCKPIT BAGS

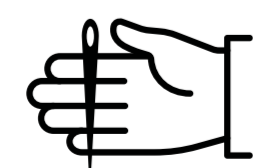

HANDMADE IN UK



LIFETIME WARRANTY



## TECH BAG

Page 28

Tech Bag

Need your stuff close to hand? Our tech bag fits the bill. Sturdily crafted from 1000D cordura and tape sealed with a roll-top, it is 100% waterproof making it an ideal home for your phone or camera.

Mount behind or in front of your bars to expand your carrying load. Fits any bike.

## TECHNICAL DETAILS

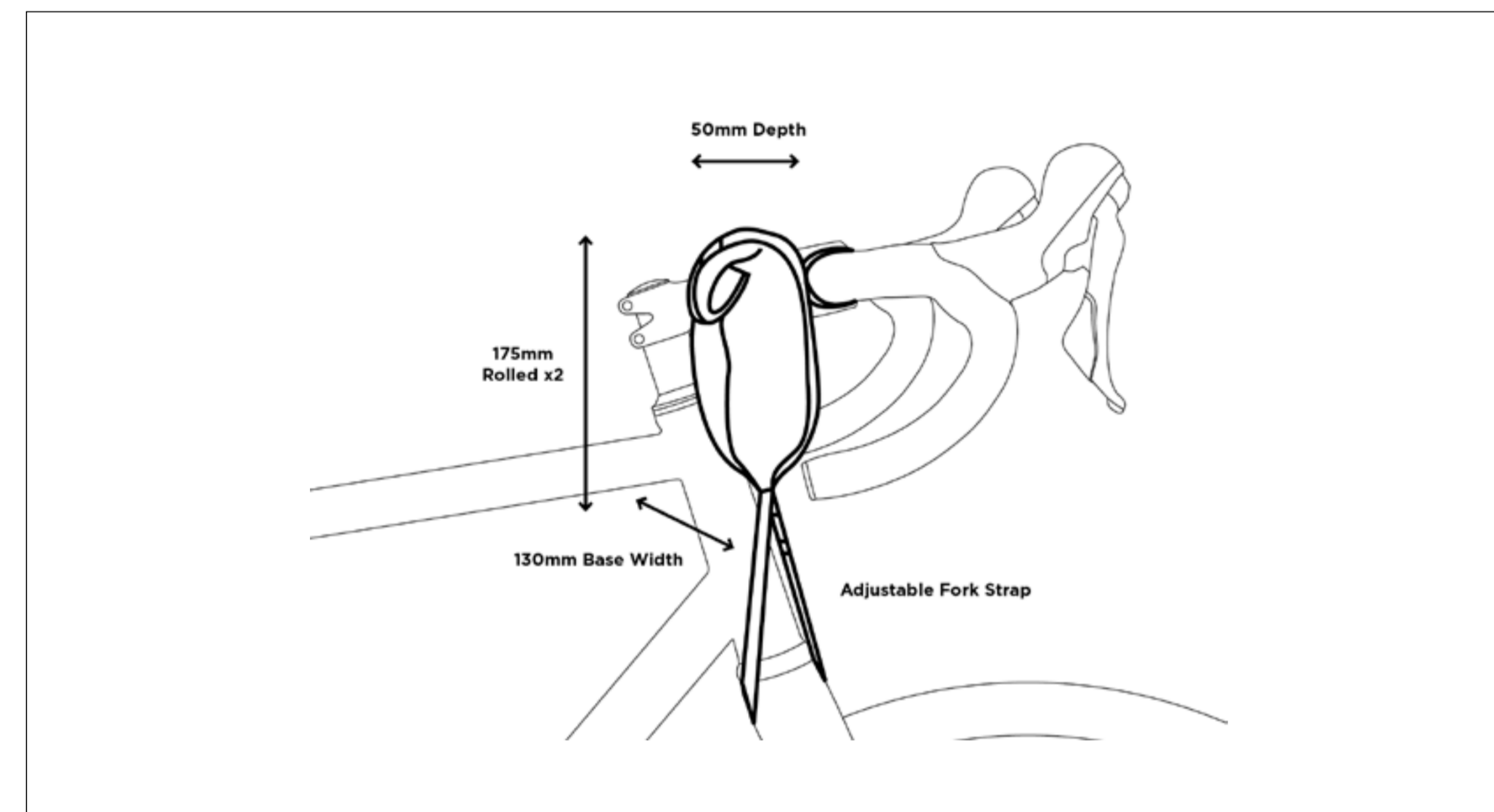

Materials	<b>Body:</b> 1000D Textured Nylon <b>Lining:</b> PU Coated Nylon <b>Webbing:</b> Nylon
Size	<b>1.2 litres Rolled Down</b> - H160mm x W130mm x D50mm <b>1.2 litres Fully Extended</b> - H300mm x W130mm x D50mm
Weight	120g
Product Codes	<b>Tech Bag</b> - RS_TBG_SML_BLK
HS Code	42029211

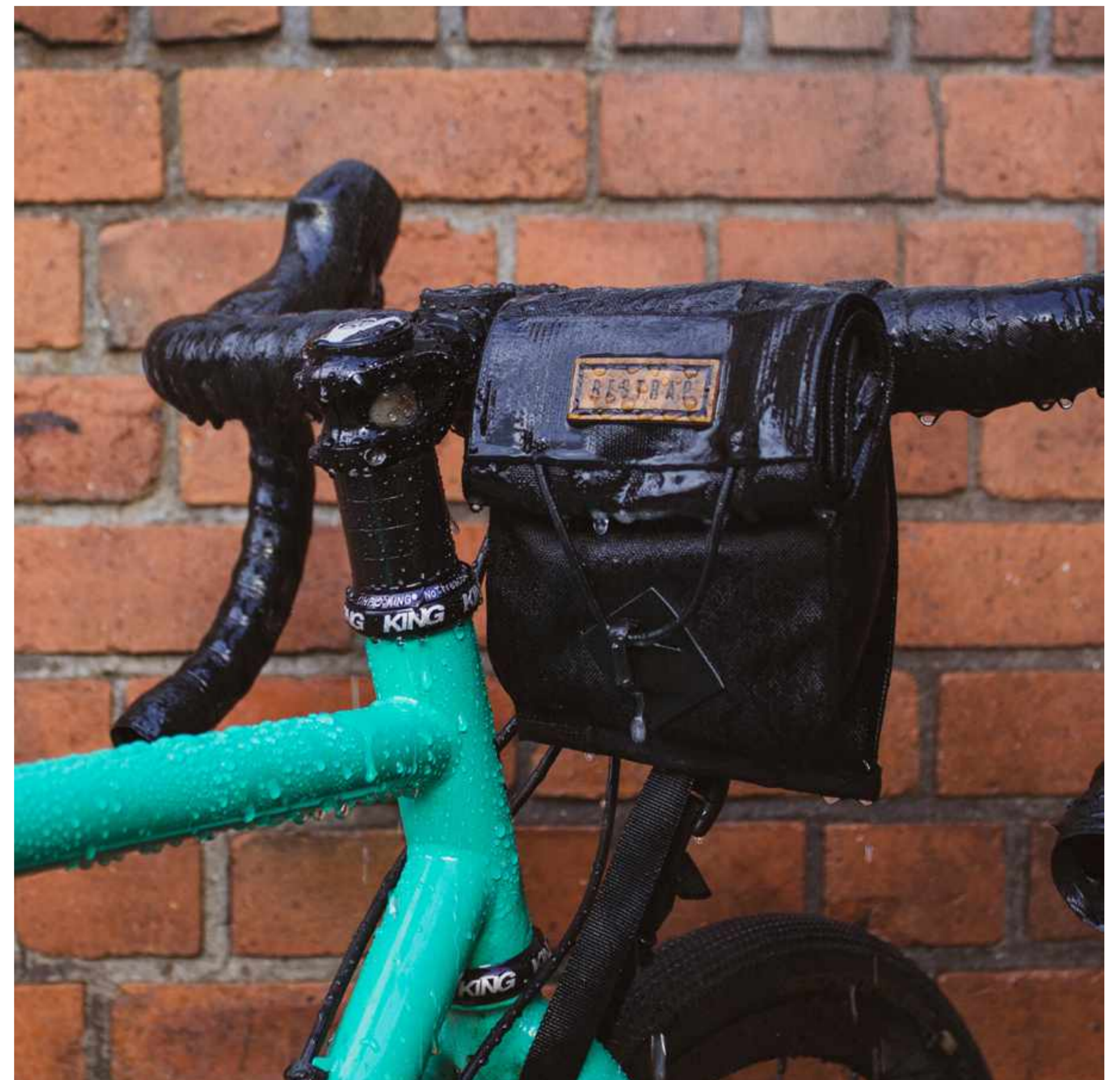

COCKPIT BAGS

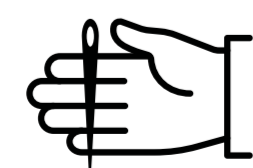

HANDMADE IN UK



LIFETIME WARRANTY





# EXPEDITION RANGE



## RANDO BAG

Page 30

The Rando rack top bag is the perfect companion for any ride. With easy access pockets, quick release rack attachment, and a handy shoulder strap, it's never been easier to carry your kit in an organised space. Fidlock magnetic fastenings and military-grade waterproof fabrics work together to make the Rando super strong and reliable.

Perfect for touring, commuting or just carrying your shopping.

## TECHNICAL DETAILS

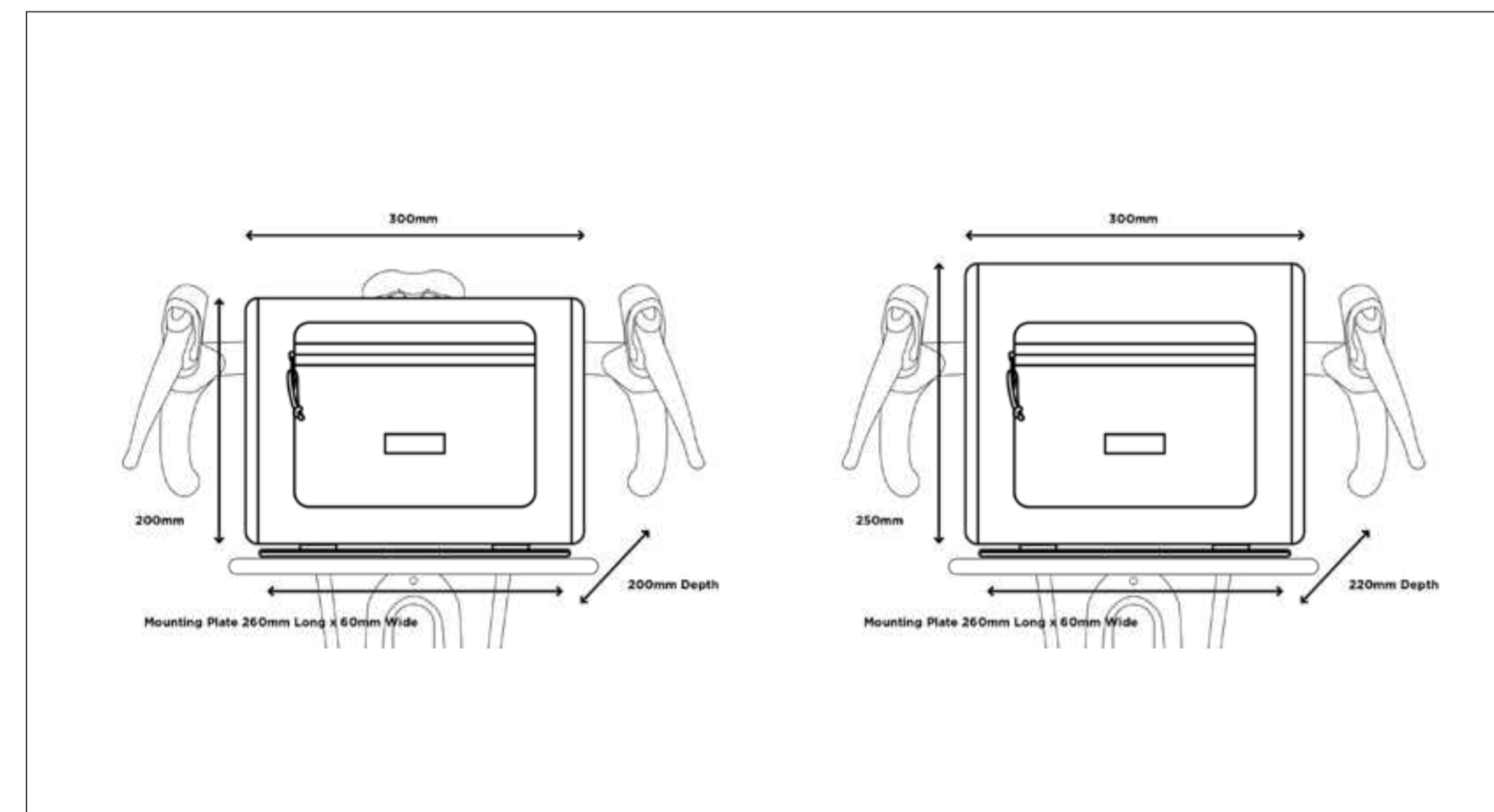

Materials	<b>Body:</b> 1000D Textured Nylon <b>Lining:</b> PU Coated Nylon <b>Webbing:</b> Nylon <b>Zipper:</b> YKK <b>Includes Fidlock Fittings</b>
Size	<b>11L</b> - W30cm x H20cm x D20cm <b>17L</b> - W30cm x H25cm x D22cm
Weight	<b>11L</b> - 795g <b>17L</b> - 970g
Product Codes	<b>11L</b> - RS_RDO_SML_BLK <b>17L</b> - RS_RDO_LRG_BLK
HS Code	42029211

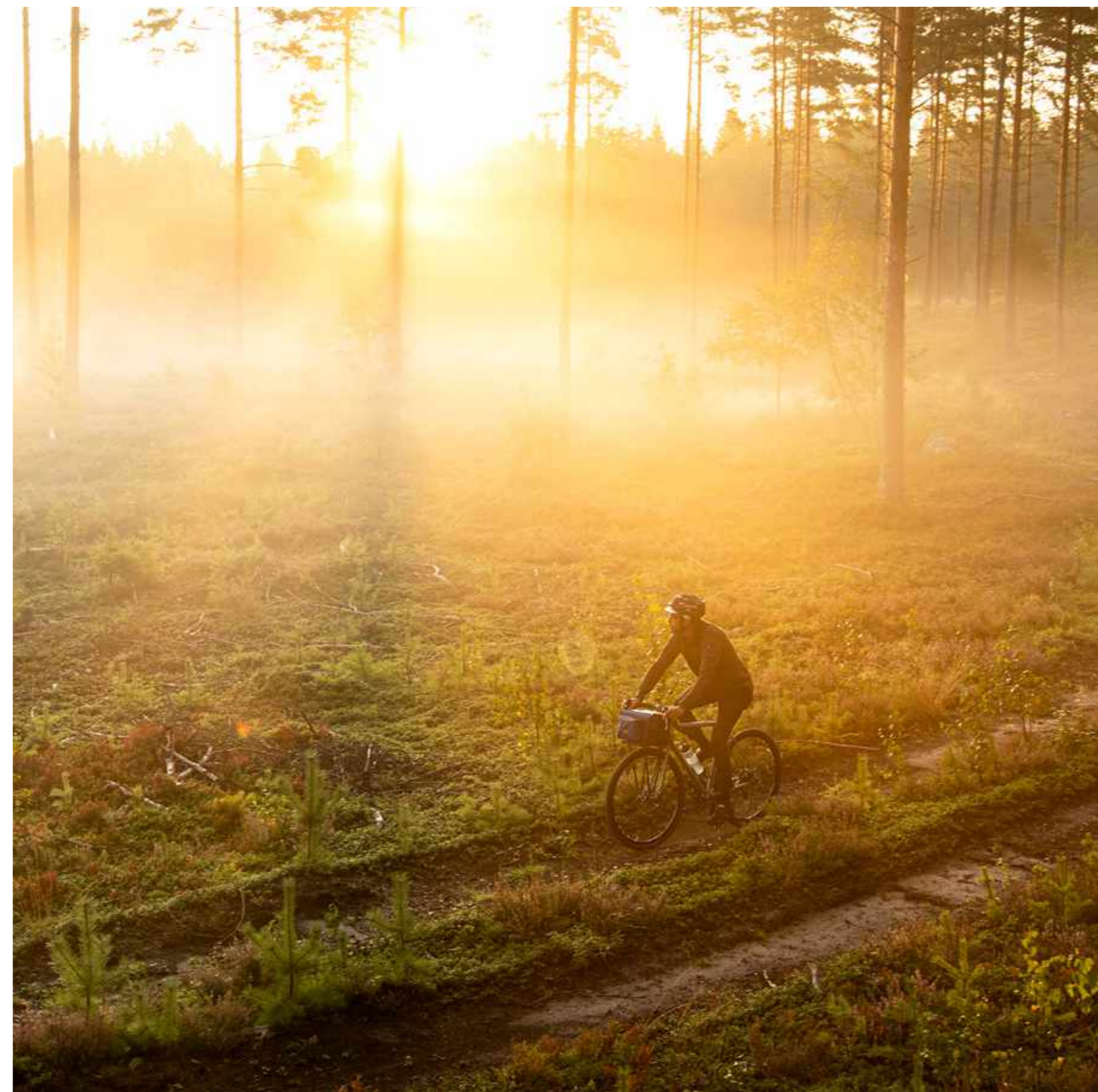

Small Rando Bag



Small Rando Bag



Large Rando Bag



Large Rando Bag



Small Rando Bag



RACK BAGS

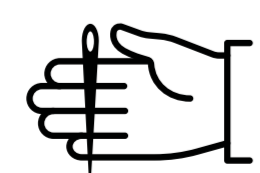

HANDMADE IN UK



LIFETIME WARRANTY



## PANNIERS

Our sleek roll-top panniers are designed for strength, stability and endurance. Available in 13 litres and 22 litres for both rear and front racks, they're fitted with magnetic buckles and contain a fully adjustable Rixon Kaul hook system for easy mounting to most racks.

Available in black and olive, the bags contain reflective detailing for improved visibility, whilst their 100% waterproof materials ensure contents remain dry and secure. Both sizes are capable of running clip-in accessories, laptop and tablet sleeve.

## TECHNICAL DETAILS

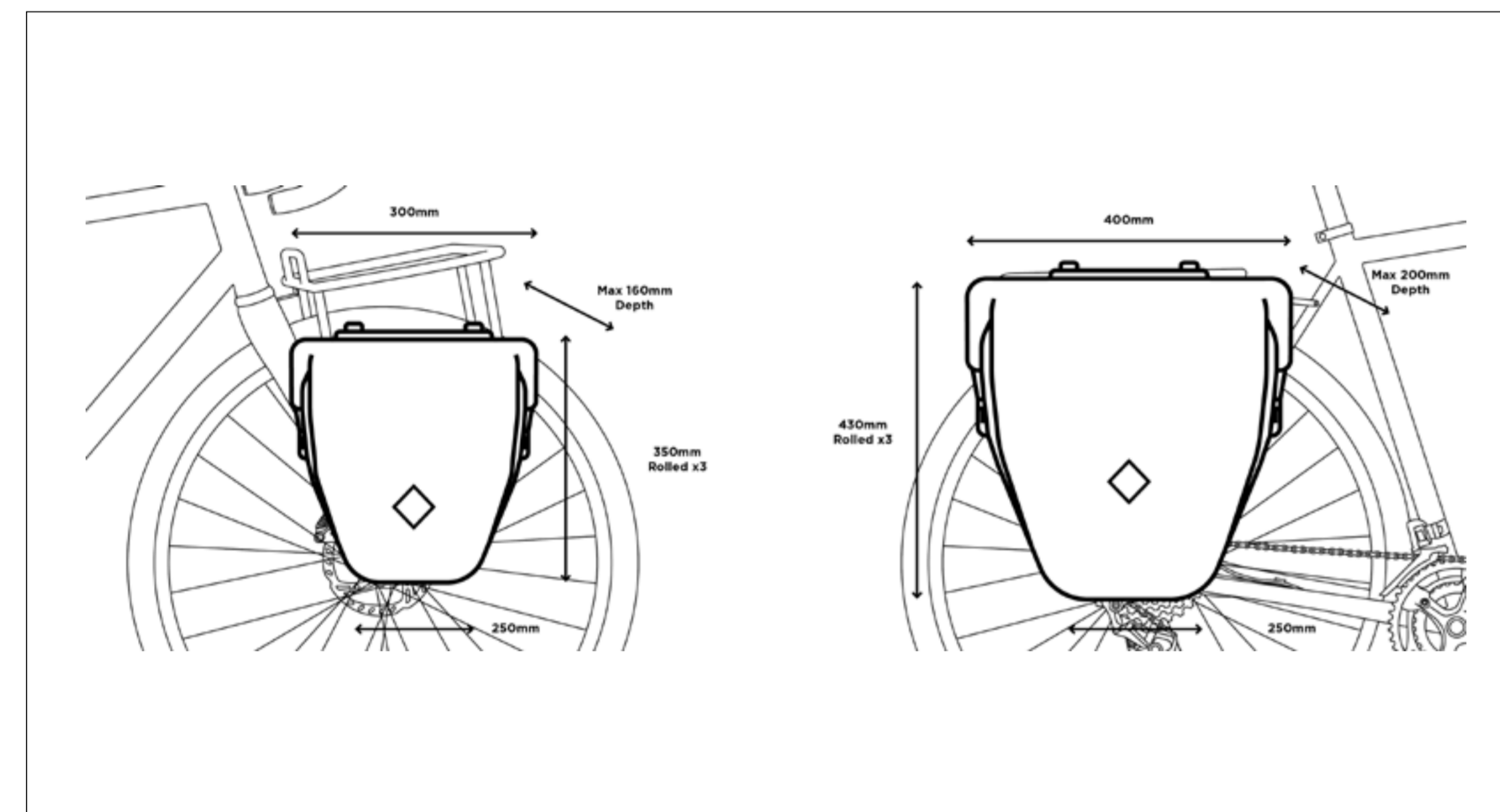

Materials	<b>Body:</b> 1000D Textured Nylon <b>Lining:</b> PU Coated Nylon <b>Webbing:</b> Nylon <b>Includes Fidlock Fittings</b>
Size	<b>13L</b> - W30cm x H30cm x D16cm <b>22L</b> - W40cm x H40cm x D16cm
Weight	<b>13L</b> - 710g <b>22L</b> - 910g
Product Codes	<b>Black 13L</b> - RS_PAN_SML_BLK <b>Black 22L</b> - RS_PAN_LRG_BLK <b>Olive 13L</b> - RS_PAN_SML_OLV <b>Olive 22L</b> - RS_PAN_LRG_OLV
HS Code	42029211

Large Pannier



Small Pannier



PANNIERS

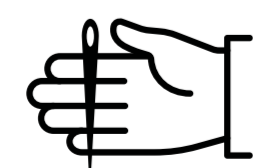

HANDMADE IN UK



LIFETIME WARRANTY



## FORK BAG

Page 32

The five-litre fork bag from Restrap offers yet more options for carrying your gear. Its 100% waterproof, roll-top design will keep your stuff dry no matter the spray and mud. Compatible with most fork cages, its two 20mm straps and the option of four sturdy attachment loops keep it securely bound, whilst its hard-wearing Hypalon bases gives it stability and grip to the fork cage.

\*Cage not included.

## TECHNICAL DETAILS

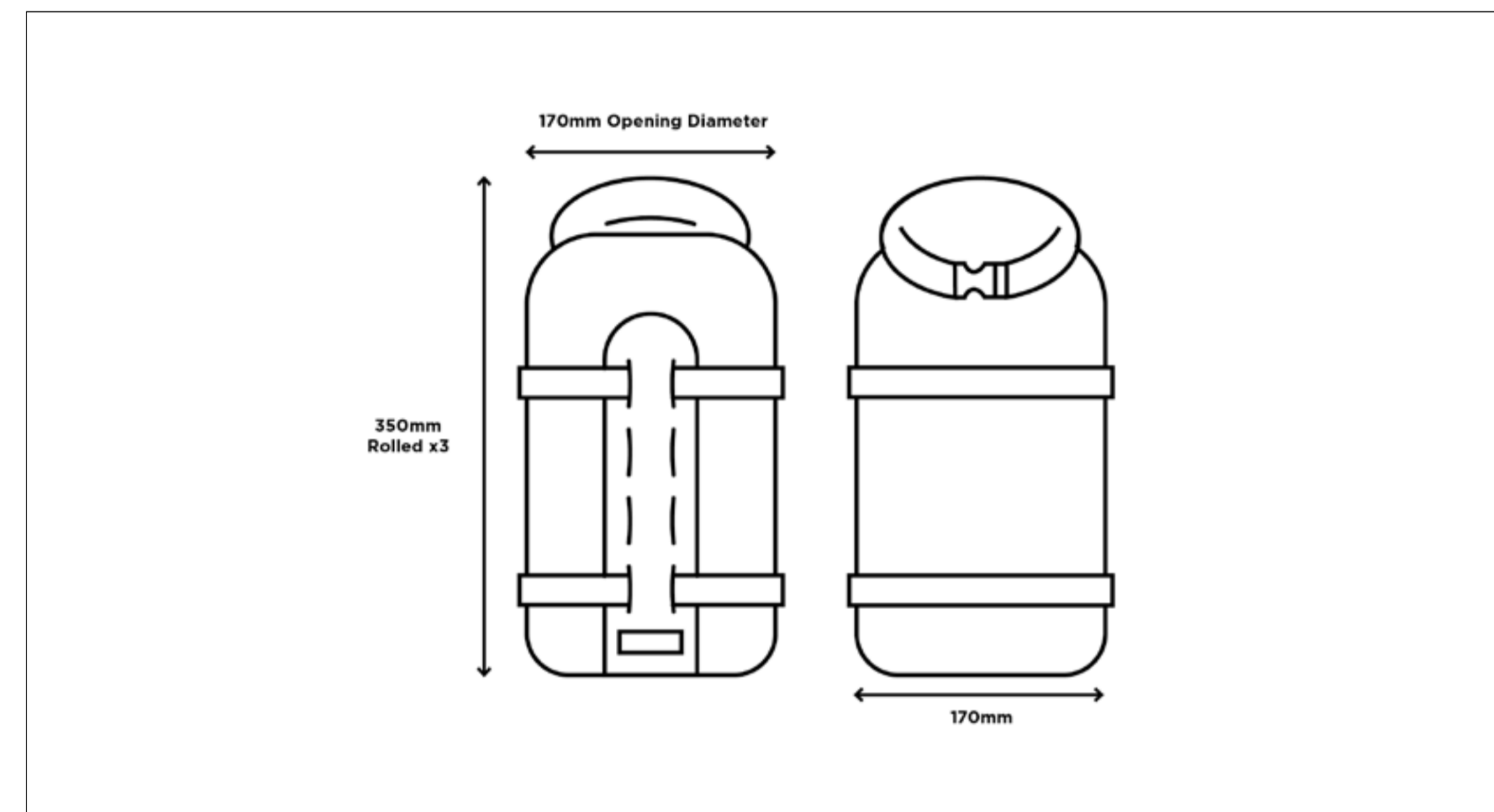

Materials	<b>Body:</b> 1000D Textured Nylon <b>Lining:</b> PU Coated Nylon <b>Webbing:</b> Nylon <b>Base and Attachment:</b> Hypalon
Size	<b>5L</b> - W17cm x H30cm x D12cm
Weight	<b>5L</b> - 198g
Product Codes	<b>5L</b> - RS_FKB_STD_BLK
HS Code	42029211



RACK BAGS

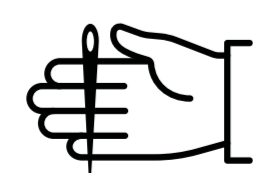

HANDMADE IN UK



LIFETIME WARRANTY



## CARRY CAGE

Page 33

The Carry Cage is a secure and versatile carrying solution that allows you to easily expand your horizons, whether you're bikepacking, touring or just exploring.

Working in perfect harmony with Restrap Fork Bags or Fast Straps, the Carry Cage accommodates a huge range of cargo from extra water bottles to camping equipment. Three adjustable mounting points allow the cage to be mounted in a variety of positions on the bike.

The Carry Cage is made from laser cut aluminium and finished with a black powder coating and Restrap branded rubber label. For guidance on fitting, please follow manufacturers recommendation for your frame/forks.

Weight - 136g  
Max. load: 3kg

### TECHNICAL DETAILS

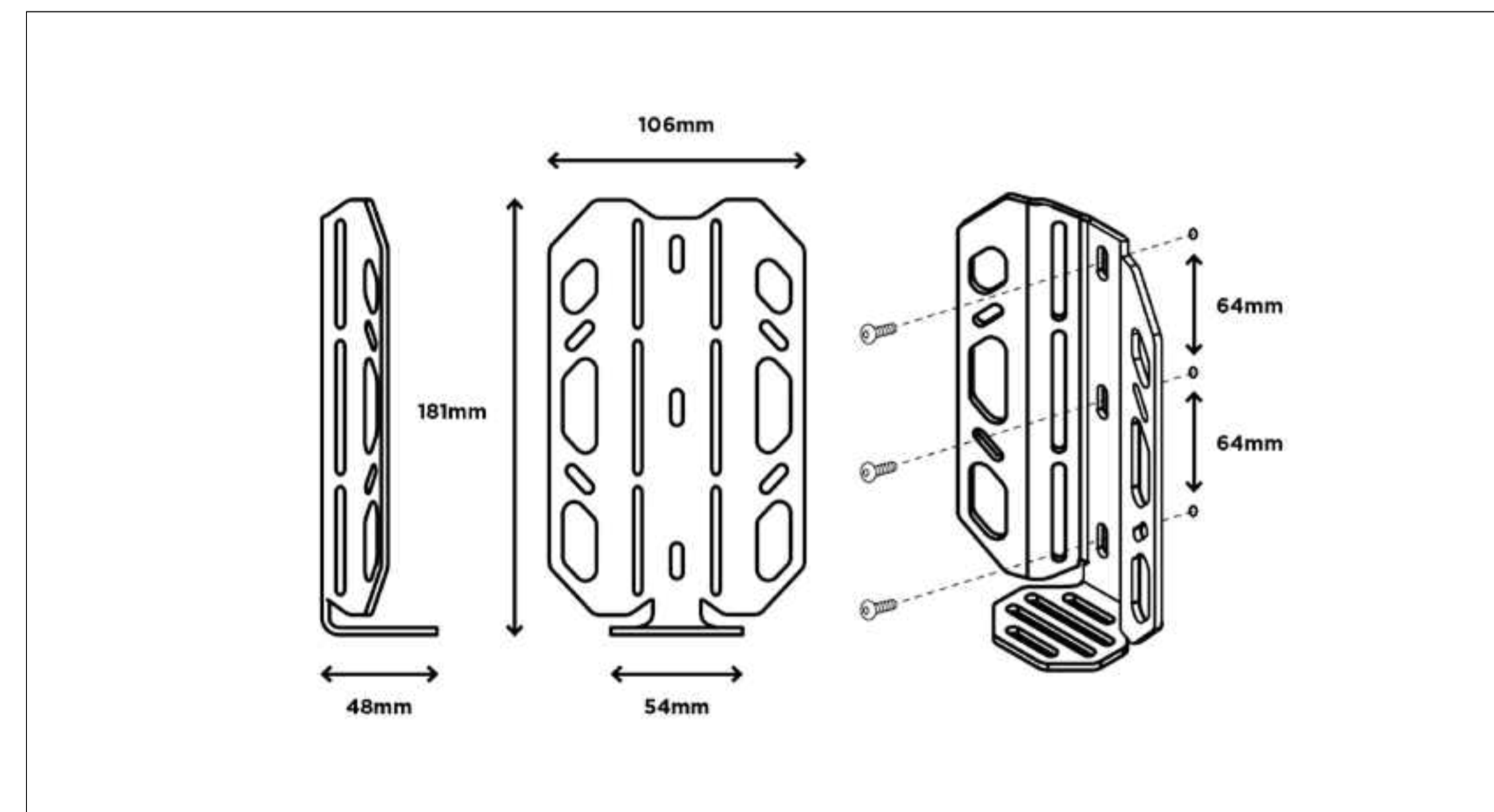

Materials	<b>Body:</b> Laser Cut Aluminium <b>Finish:</b> Black Powder Coating
Size	W106mm x H181mm x D48mm
Weight	136g
Product Codes	RS_HDW_CCG_BLK
HS Code	8714993000

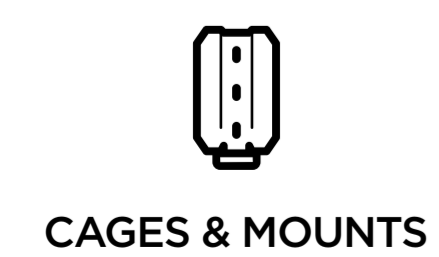



## DRY BAG SPARES

Restrap roll-top dry bags are available in 14L as a double-roll, 8L and 14L tapered for our saddlebag holsters and 7L for our Adventure Race Saddle and Aero Bar Bags. The bags are 100% waterproof. Ideal for all adventures both on and off the bike, and essential for defending your gear against any weather.

## TECHNICAL DETAILS

Materials	<b>Body:</b> Nylon <b>Webbing:</b> Nylon
Size	<b>7L</b> - H33cm x D15cm <b>8L</b> - H45cm x D15cm <b>14L</b> - H55cm x D18cm
Weight	<b>7L</b> - 58g <b>8L</b> - 110g <b>14L</b> - 110g
Product Codes	<b>8L Tapered</b> - RS_DB5_8L_BLK <b>14L Tapered</b> - RS_DB4_14L_BLK <b>14L Double Roll</b> - RS_DB2_14L_BLK <b>7L Race</b> - RS_RDB_07L_BLK
HS Code	42029211



ALL BAGS





**CITY RANGE**



## CITY LOADER

Page 36

Two fully waterproof, fold-closure, compartments offer up to 20 litres of internal storage. The main compartment is secured by an adjustable fastening strap with a Fidlock™ buckle, which offers additional external storage for the likes of a jacket or dry bag.

Compression straps on the sides of the bag act to keep the bag compact for smaller loads, whilst also securing accessories like bottles or locks stored in the side pockets. Reflective detailing, incorporated onto the front pocket, ensures good visibility for night time commutes.

A removable shoulder strap and carry handle, at the rear of the bag, make the City Loader comfortable and convenient when off the bike.

The bag is mounted via a Brompton front carrier block compatible fitting, both external and internal stiffeners enable the bag to hold its shape even when fully loaded. Made of 100% waterproof textured nylon, spare clothes and tech are guaranteed to stay dry on the wettest of commutes. The bag is also compatible with a Brompton front light, dyno light and front reflector.

Like all our City Range bags, the City Loader does not impact the folding mechanism of the bike.

## TECHNICAL DETAILS

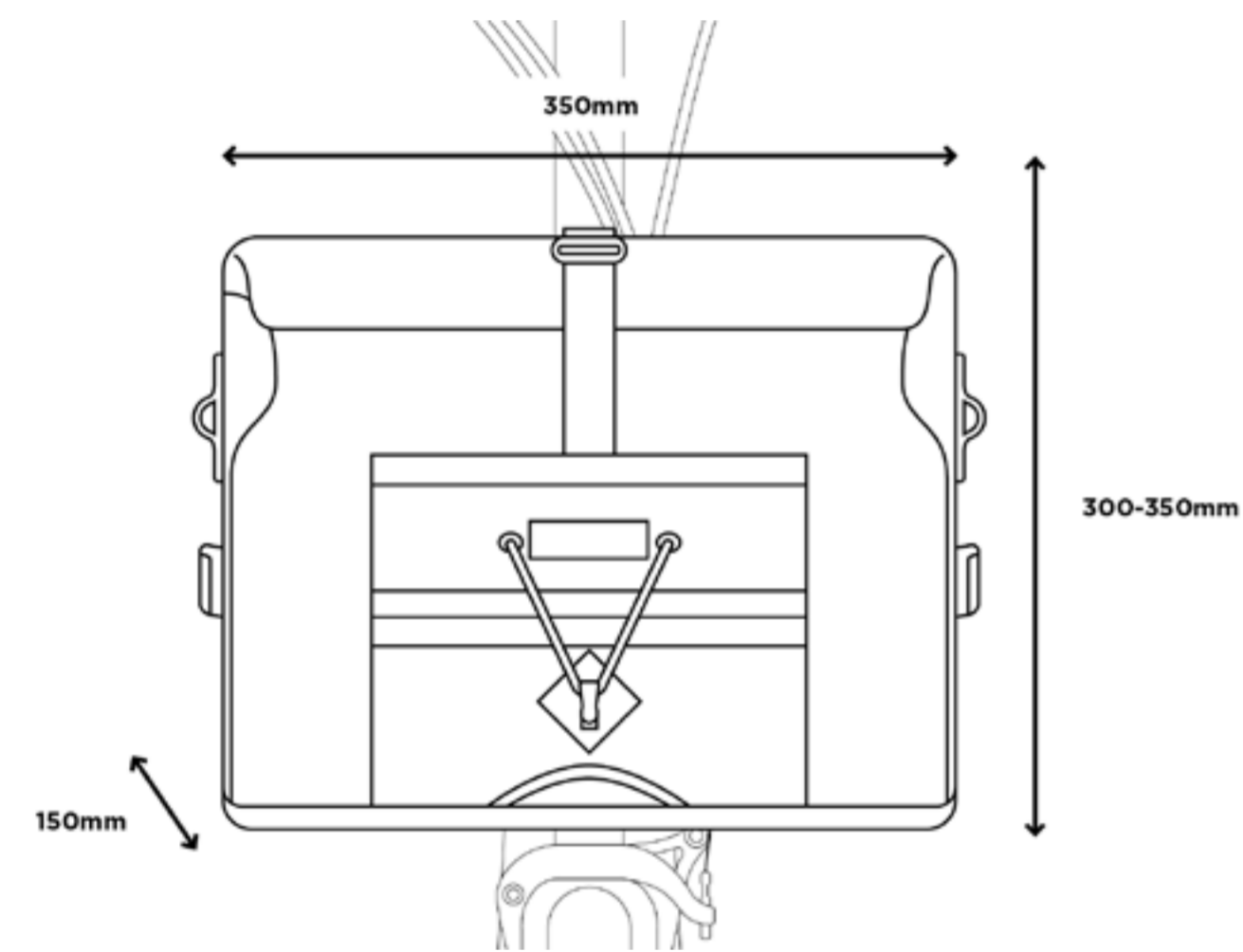

Materials	<b>Body:</b> 1000D Textured Nylon, Internal 1.5mm Polypropolene Stiffener, 3mm Polypropolene Backplate <b>Lining:</b> PU Coated Nylon <b>Webbing:</b> Nylon
Size	<b>20L</b> - H30-35cm x D15cm x W35cm
Weight	1600g
Product Codes & EAN Barcodes	<b>Black</b> - RS_BBL_STD_BLK <b>Navy</b> - RS_BBL_STD_NVY <b>Olive</b> - RS_BBL_STD_OLV
HS Code	4202921100

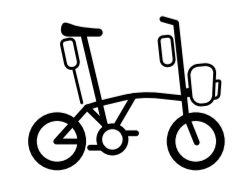

FOLDING-BIKE BAGS

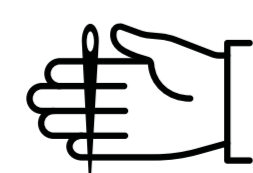

HANDMADE IN UK



LIFETIME WARRANTY



## CITY BAR BAG

Page 37

The Restrap City Range offers versatile carrying solutions for folding bikes. Whether commuting or for leisure, the City Range enables you to take what you need, where you need it, in a smart system that fully complements the unique design of your bicycle.

Designed to fit the M and H style Brompton handlebars, the 1.2 Litre City Bar Bag is made from tough fabrics and is tape sealed - making it completely waterproof. Perfect for carrying keys, phone and wallet.

Available in Black, Olive and Navy.

## TECHNICAL DETAILS

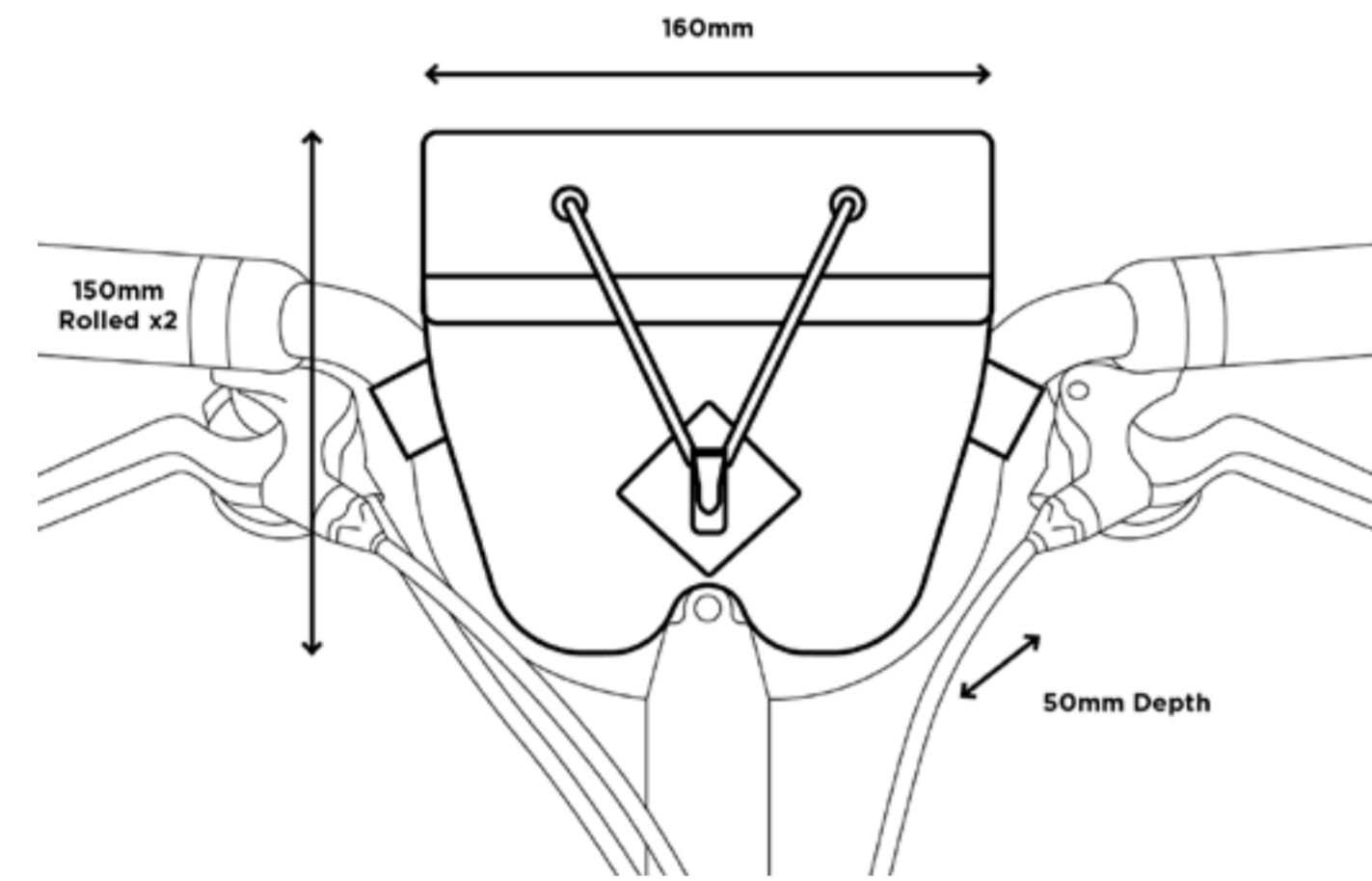

Materials	<b>Body:</b> Polyester Laminate <b>Lining:</b> PU Coated Nylon <b>Webbing:</b> Nylon
Size	<b>1.2L</b> - H14cm x D5cm x W16cm
Weight	<b>1.2L</b> - 110g
Product Codes	<b>Black</b> - RS_BBB_STD_BLK <b>Navy</b> - RS_BBB_STD_NVY <b>Olive</b> - RS_BBB_STD_OLV
HS Code	42029211

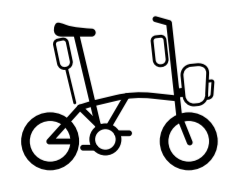
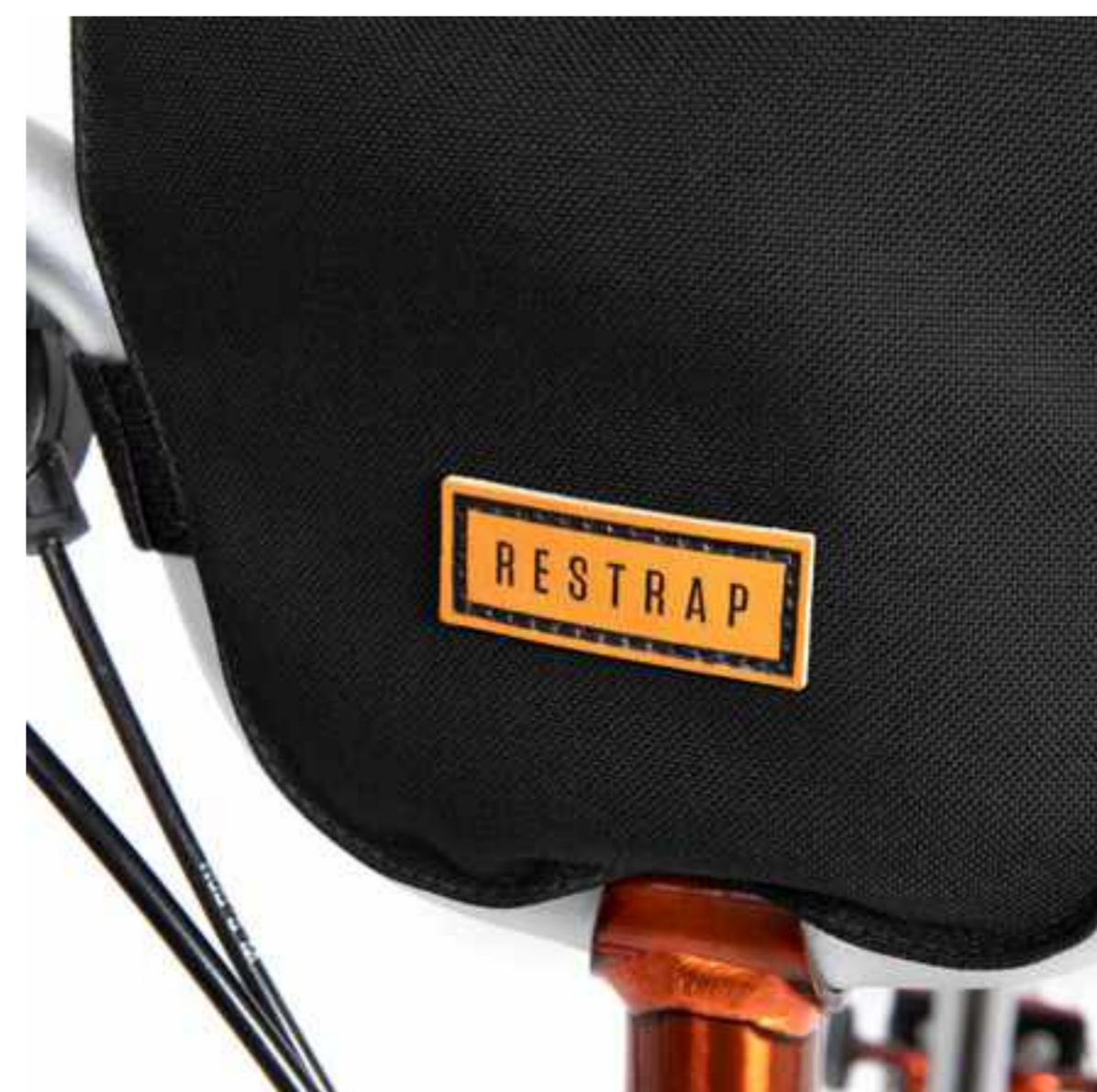

FOLDING-BIKE BAGS

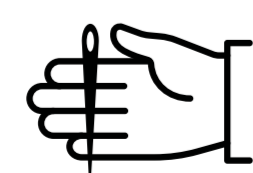

HANDMADE IN UK



LIFETIME WARRANTY



## CITY STEM BAG

Page 38

The Restrap City Range offers versatile carrying solutions for folding bikes. Whether commuting or for leisure, the City Range enables you to take what you need, where you need it, in a smart system that fully complements the unique design of your bicycle.

The 1 Litre City Stem Bag fits any folding bicycle. Made from tough waterproof fabrics, it provides a simple solution for carrying a water bottle, snacks or other accessories. The bag moves with the stem, and does not impact the folding mechanism of the bike.

Available in Black, Olive and Navy.

## TECHNICAL DETAILS

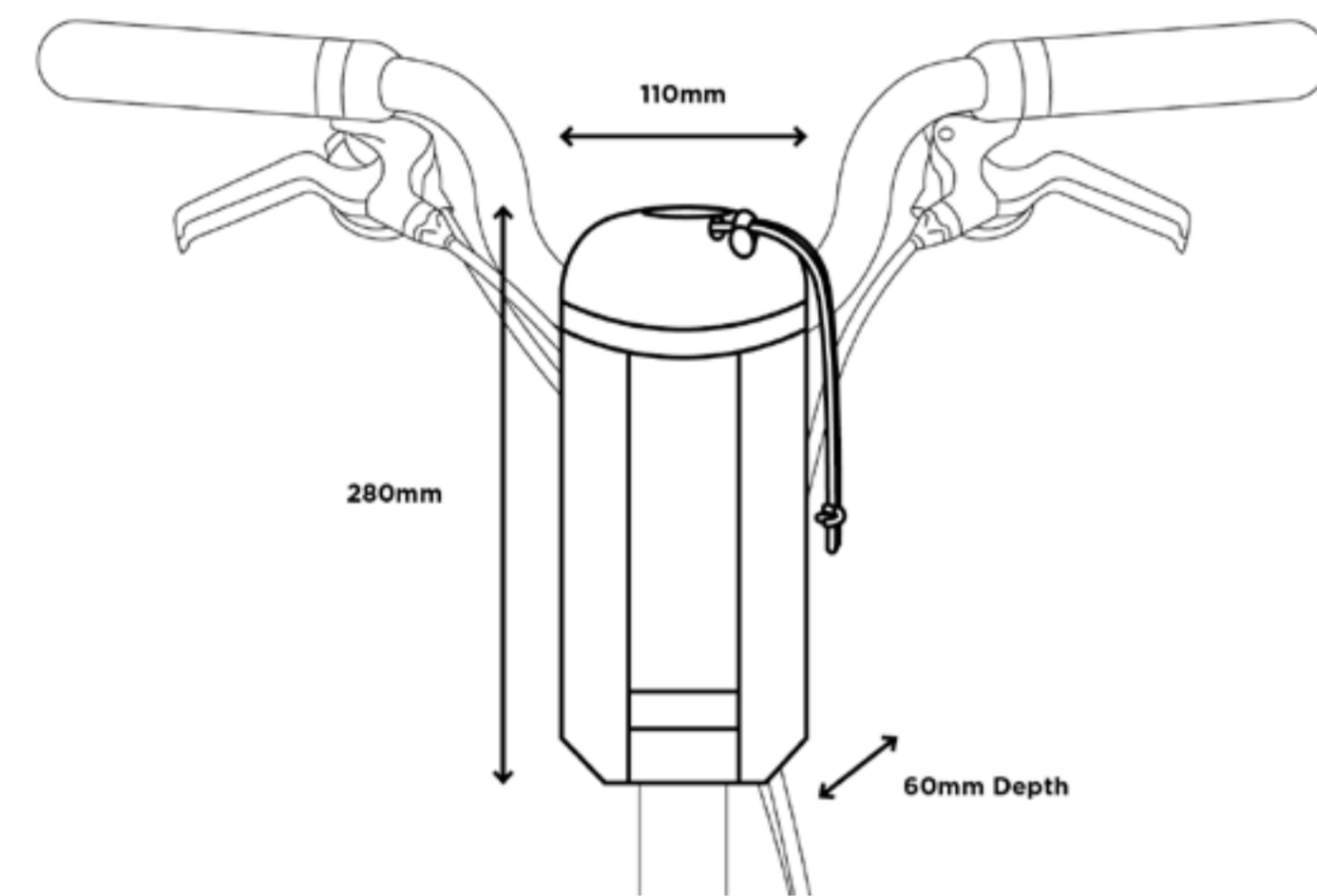

Materials	<b>Body:</b> Polyester Laminate <b>Lining:</b> PU Coated Nylon <b>Webbing:</b> Nylon
Size	<b>1L</b> - H27cm x W7cm x D10cm
Weight	<b>1L</b> - 120g
Product Codes	<b>Black</b> - RS_FBS_STD_BLK <b>Navy</b> - RS_FBS_STD_NVY <b>Olive</b> - RS_FBS_STD_OLV
HS Code	42029211

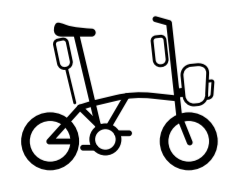
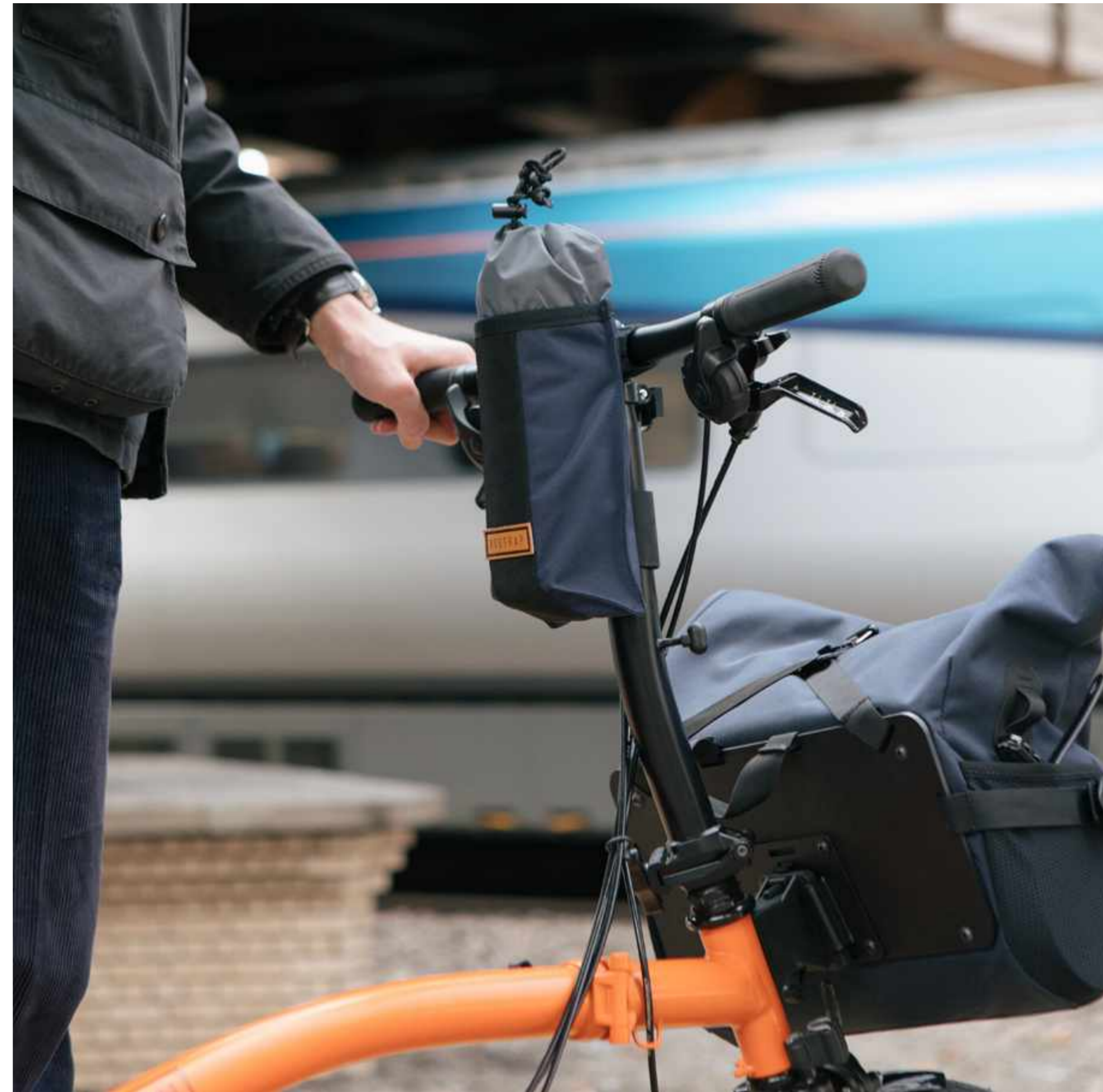

FOLDING-BIKE BAGS

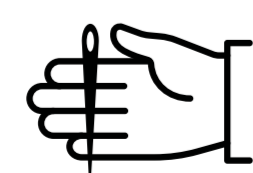

HANDMADE IN UK



LIFETIME WARRANTY



## CITY SADDLE BAG

Page 39

The Restrap City Range offers versatile carrying solutions for folding bikes. Whether commuting or for leisure, the City Range enables you to take what you need, where you need it, in a smart system that fully complements the unique design of your bicycle.

The 1 Litre City Stem Bag fits any folding bicycle. Made from tough waterproof fabrics, it provides a simple solution for carrying a water bottle, snacks or other accessories. The bag moves with the stem, and does not impact the folding mechanism of the bike.

Available in Black, Olive and Navy.

## TECHNICAL DETAILS

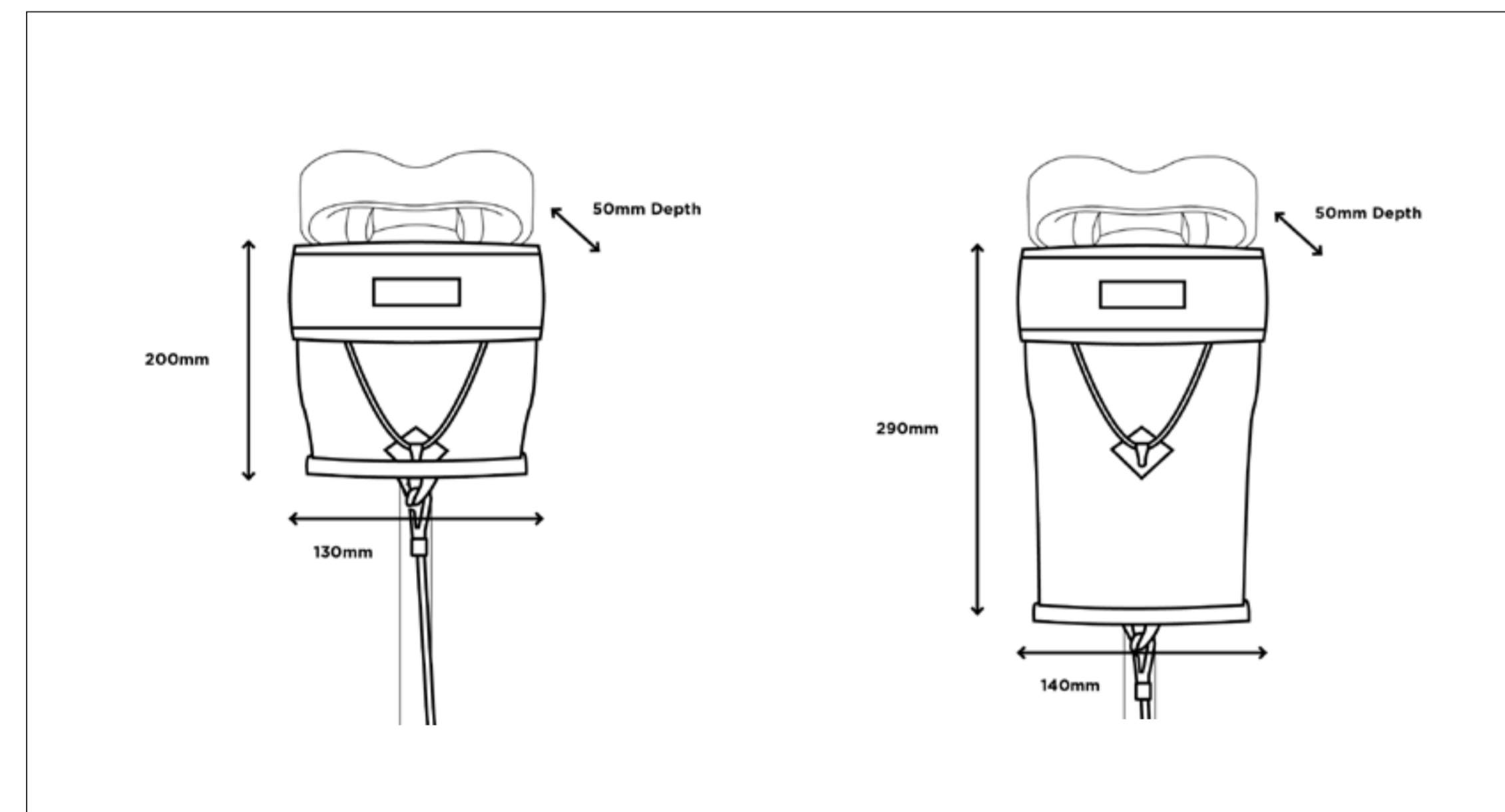

Materials	<b>Body:</b> Polyester Laminate <b>Lining:</b> PU Coated Nylon <b>Webbing:</b> Nylon
Size	<b>Small - 1.2L</b> - H18cm x D5cm x W14cm <b>Large - 2L</b> - H27cm x D5cm x W14cm
Weight	<b>Small</b> - 120g <b>Large</b> - 150g
Product Codes	<b>Small Black</b> - RS_FSB_SML_BLK <b>Small Navy</b> - RS_FSB_SML_NVY <b>Small Olive</b> - RS_FSB_SML_OLV <b>Large Black</b> - RS_FSB_LRG_BLK <b>Large Navy</b> - RS_FSB_LRG_NVY <b>Large Olive</b> - RS_FSB_LRG_OLV
HS Code	42029211

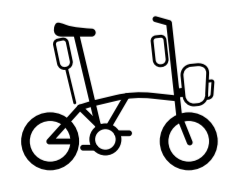
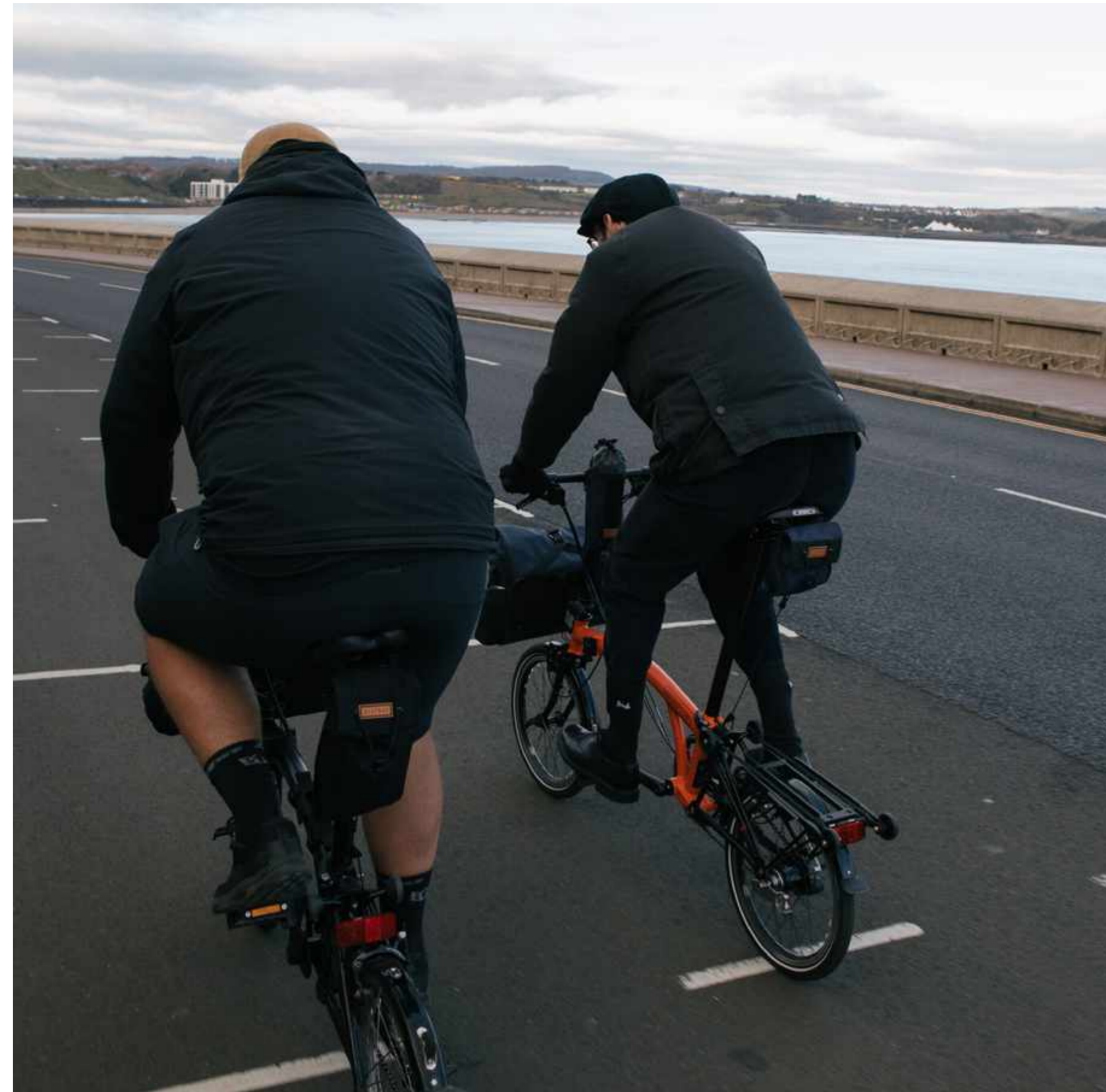

FOLDING-BIKE BAGS

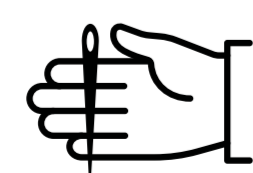

HANDMADE IN UK



LIFETIME WARRANTY



## CITY CARRY HANDLE

Page 40

Keep your bike by your side with our City Strap. Tough Hypalon straps allow you to carry your folded bike while stowed away, and stay out of harms away when you're on the move. Includes shoulder strap to help carrying comfort.

## TECHNICAL DETAILS

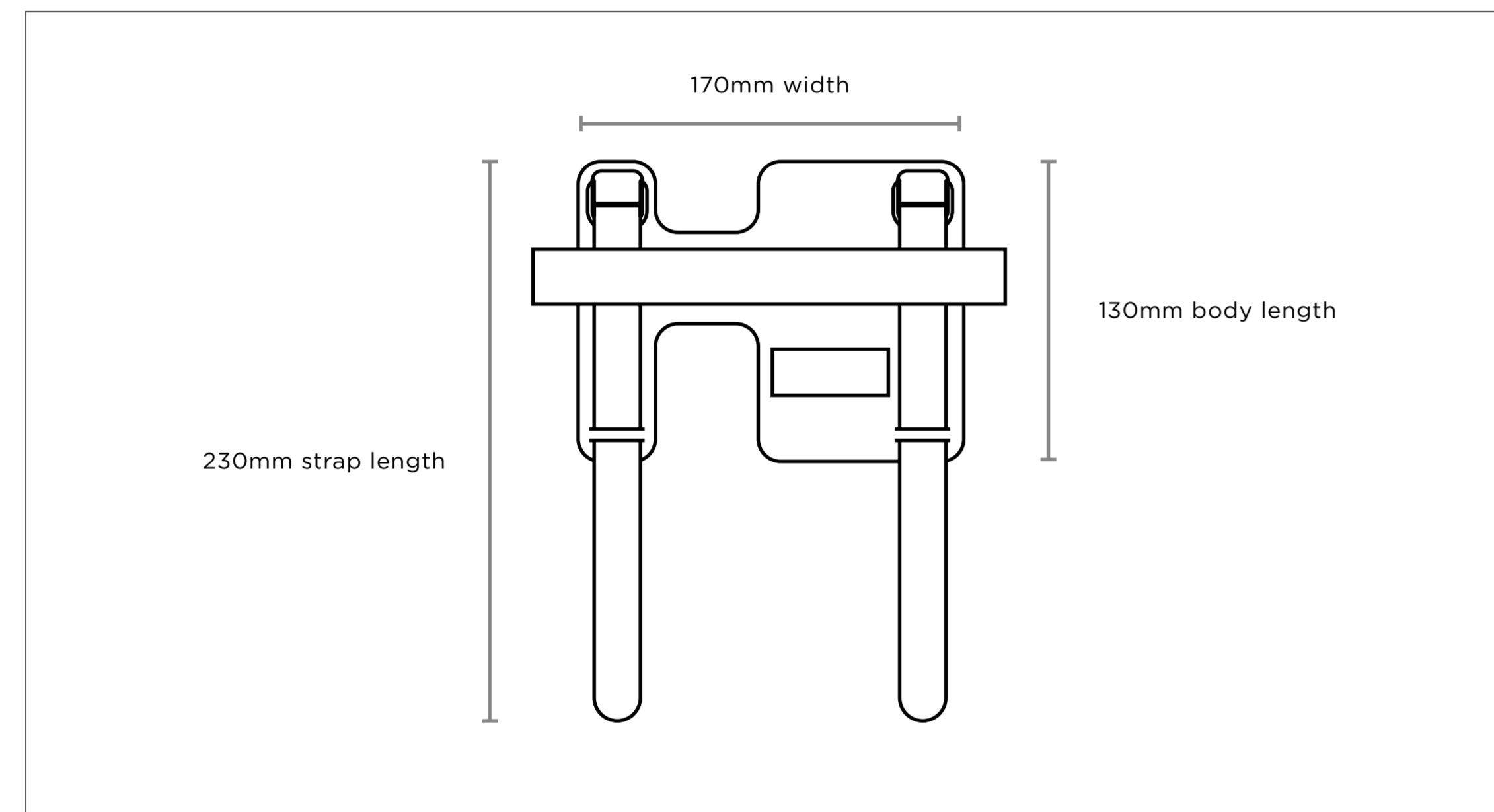

Materials	<b>Body:</b> Hypalon <b>Buckles:</b> Nylon
Size	H13cm x W17cm
Weight	92g
Product Codes	RS_HDL_STD_BLK
HS Code	63079098

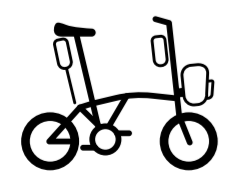
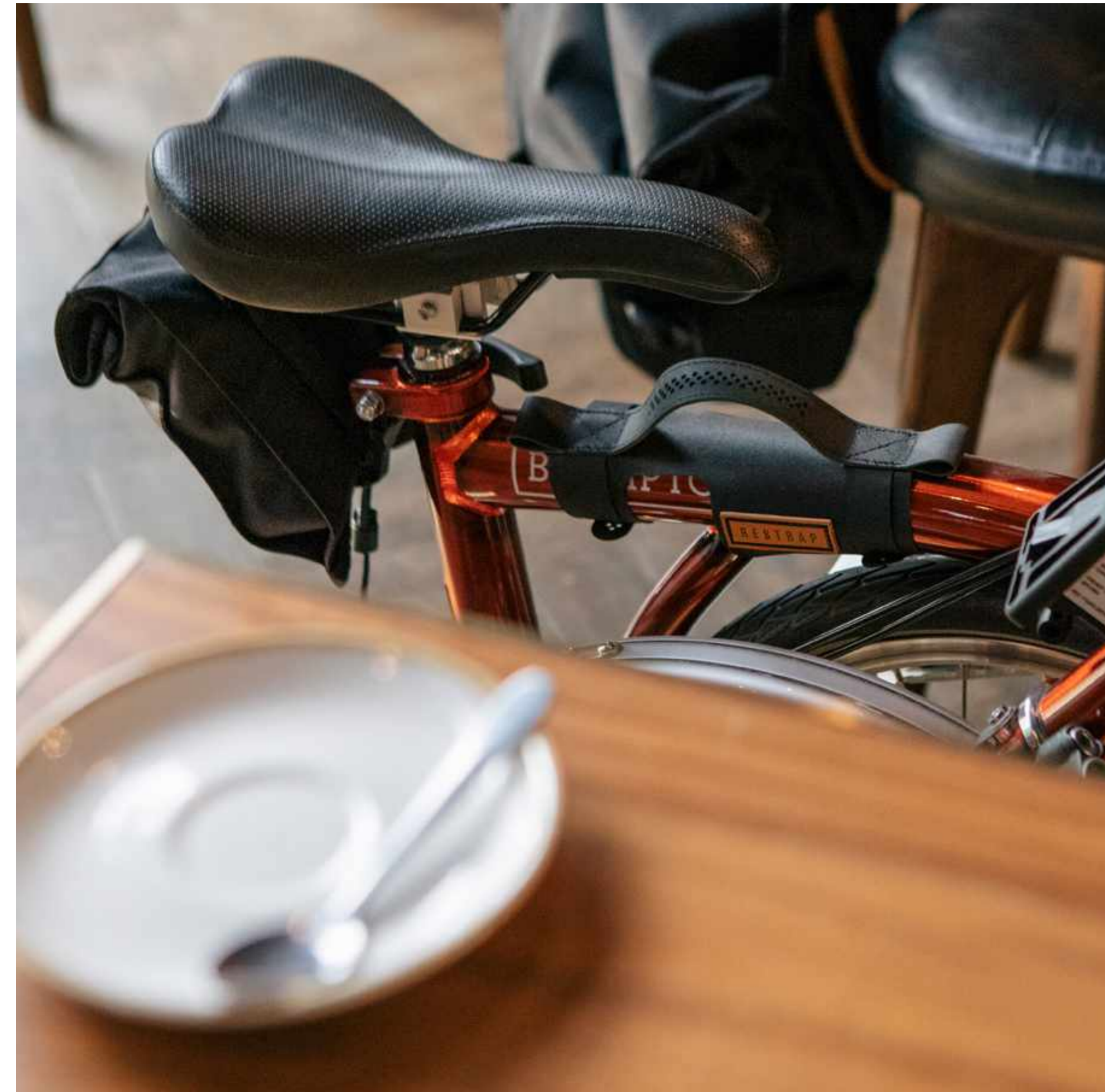

FOLDING-BIKE BAGS

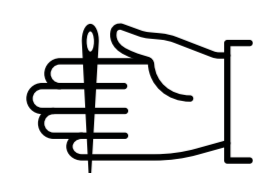

HANDMADE IN UK



LIFETIME WARRANTY



## CITY PULL TAB

Page 41

Unclip luggage from the Brompton front carrier block quickly and easily with our City Pull Tab. Made from Hypalon, the strap is lightweight, easy to install and is a great add-on for those regularly travelling with luggage on a Brompton.

Includes M5 fixing nut & bolt.

## TECHNICAL DETAILS

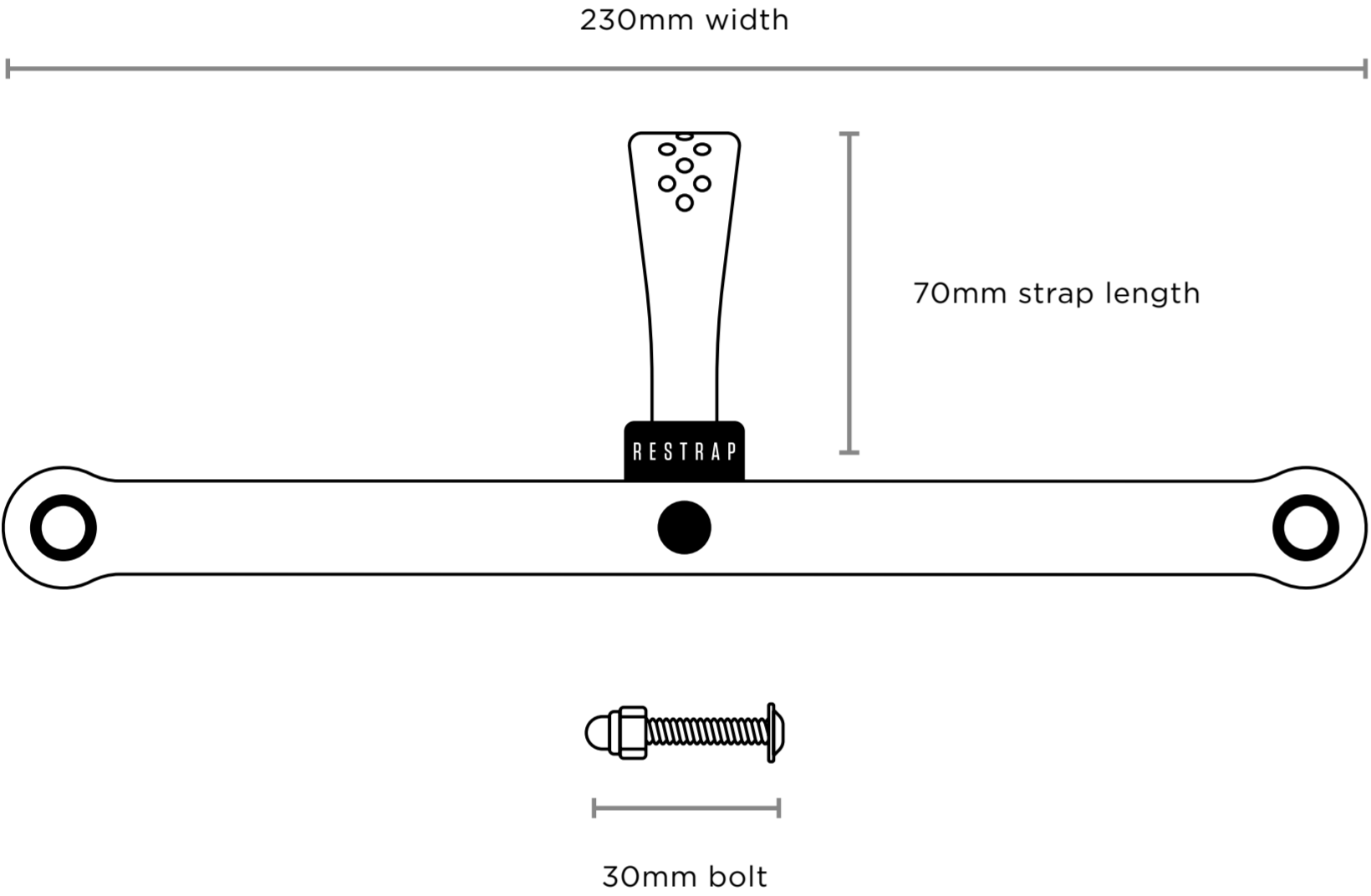
	
Materials	<b>Body:</b> Nylon & Hypalon <b>Fitting:</b> M5 Bolt
Size	230mm x 80mm
Weight	17g
Product Codes	RS_CPT_STD_BLK
HS Code	63079098

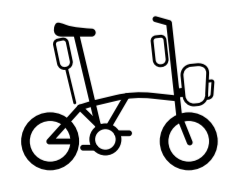
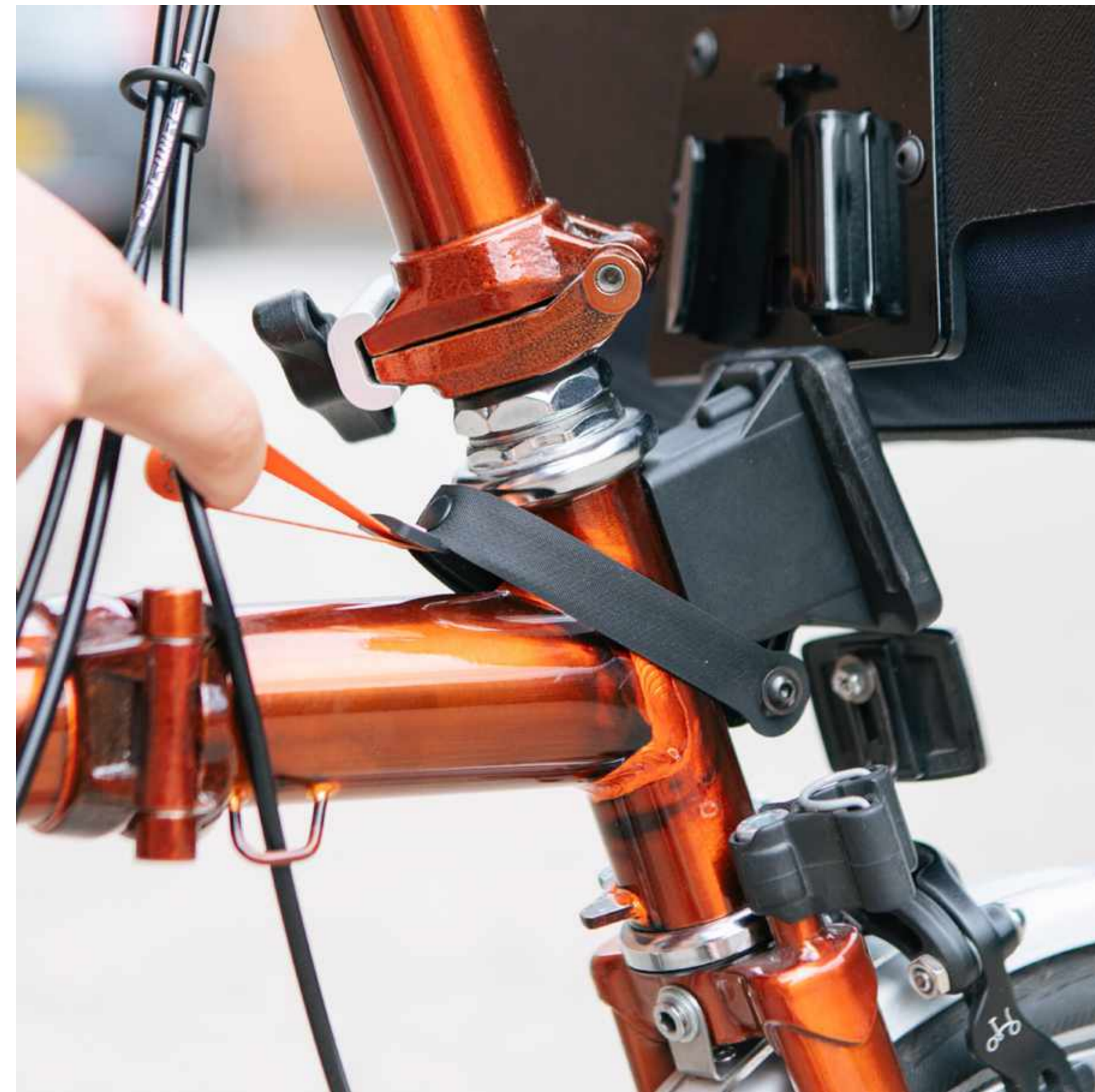

FOLDING-BIKE BAGS

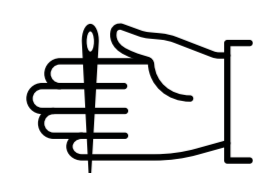

HANDMADE IN UK



LIFETIME WARRANTY





**STRAPS**



## RACK STRAPS

Page 43

Restrap Rack Straps are a strong, secure and versatile way to attach luggage to your bike-rack. Say goodbye to flimsy bungee cords – our straps are made from thick elastic webbing that's specially manufactured for us in the UK. Simply attach the straps to your rack with our super-strong rubber o-rings and magnetic buckle. With a break strength of 50kg and a ladderlock system for length adjustment, our luggage straps guarantee flexibility for larger or more awkwardly shaped items whilst being exceptionally secure.

Length - 55 to 75cm  
Comes in pairs of two.

## TECHNICAL DETAILS

Materials	<b>Material:</b> 30mm Elastic Webbing <b>Fittings:</b> Magnetic
Size	L55-75cm x W3cm
Weight	150g
Product Codes	<b>Black</b> - RS_RST_STD_BLK
HS Code	63079098

Rack Straps

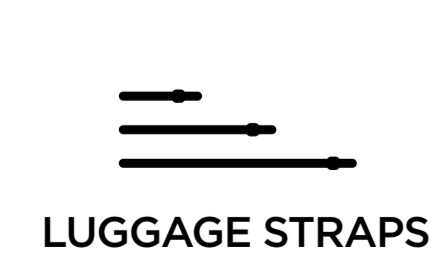



## FRAME STRAP

Page 44

Our Frame Strap is the perfect solution for carrying extra items and riding essentials on your bike. Ideal for mountain bikes or boosting the capacity of your current bikepacking setup.

Made from grippy and hard wearing Hypalon, the Frame Strap mounts securely to any part of the frame of your bike using fully adjustable velcro attachment to fit various sizes of tubing. Finished with a Restrap silicone label.

Weight - 40g

## TECHNICAL DETAILS

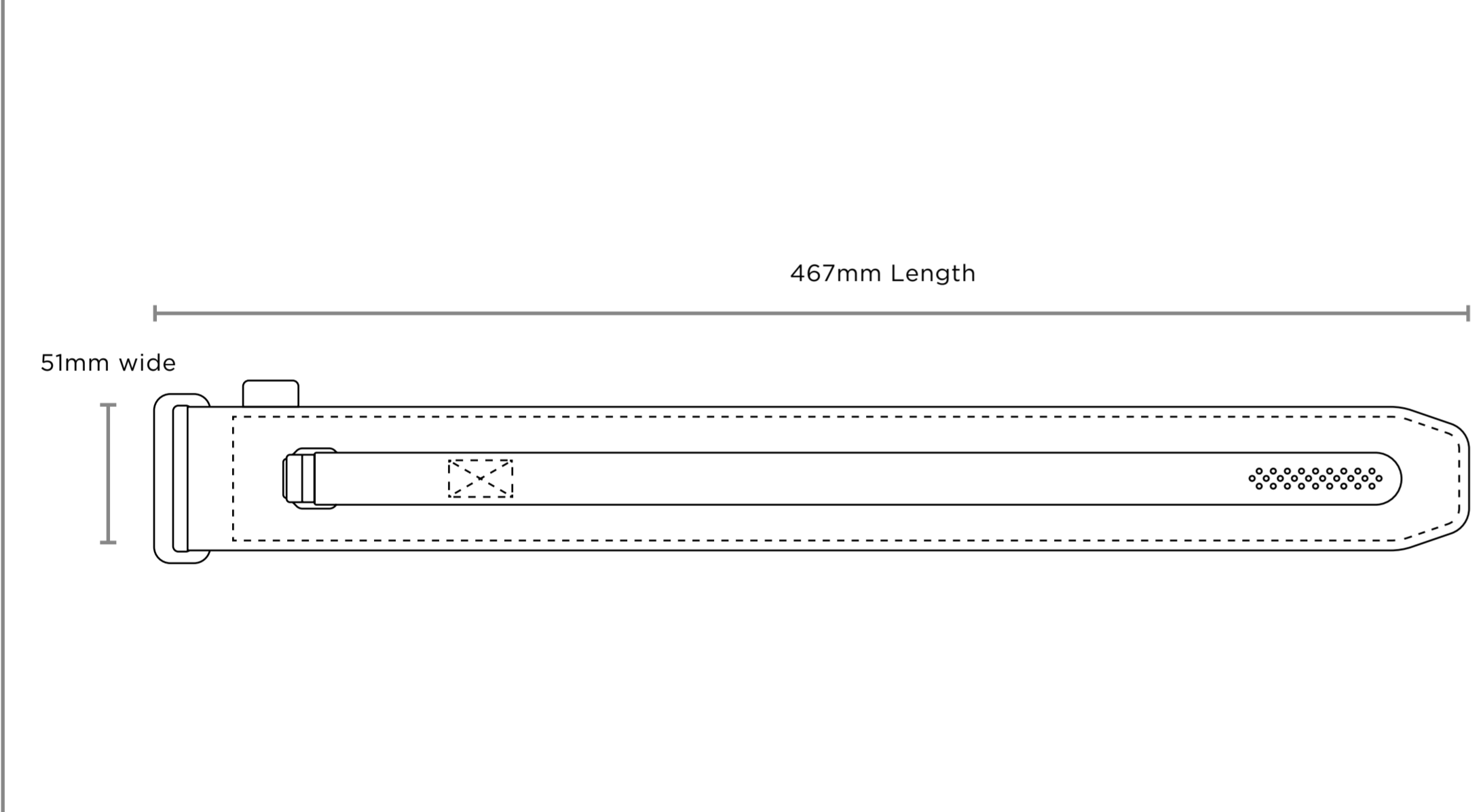

Materials	<b>Material:</b> Hypalon & Velcro <b>Buckles:</b> Nylon <b>Label:</b> Silicone
Size	<b>467mm x 51mm</b>
Weight	<b>40g</b>
Product Codes	<b>Black</b> - RS_FRM_STP_BLK <b>Orange</b> - RS_FRM_STP_ORA
HS Code	63079098

Frame Strap - Black



Frame Strap - Orange

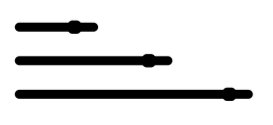

  
LUGGAGE STRAPS

  
HANDMADE IN UK

  
LIFETIME WARRANTY



## FAST STRAPS

Page 45

Whether it's carrying luggage anywhere on the bike, for tying items together, or even repairs - our tough Hypalon straps are designed to be versatile and hold steady.

Available in three sizes, 25cm, 45cm and 65cm.  
Sold as pairs or a mix of all three.

## TECHNICAL DETAILS

	<p><b>Large:</b> 65cm Length</p> <p>2cm wide</p> <p><b>Medium:</b> 45cm Length</p> <p>2cm wide</p> <p><b>Small:</b> 25cm Length</p> <p>2cm wide</p>
Materials	<b>Material:</b> Hypalon <b>Buckles:</b> Nylon
Size	<b>Small:</b> L25cm x W2cm <b>Medium:</b> L45cm x W2cm <b>Large:</b> L65 x W2cm
Weight	<b>Small:</b> 6g each <b>Medium:</b> 8g each <b>Large:</b> 10g each
Product Codes	<b>Black Small</b> - RS_FST_SML_BLK <b>Black Medium</b> - RS_FST_MED_BLK <b>Black Large</b> - RS_FST_LRG_BLK <b>Black Mix</b> - RS_FST_MIX_BLK <b>Orange Small</b> - RS_FST_SML_ORA <b>Orange Medium</b> - RS_FST_MED_ORA <b>Orange Large</b> - RS_FST_LRG_ORA <b>Orange Mix</b> - RS_FST_MIX_ORA
HS Code	63079098

Black Fast Straps Mix Pack

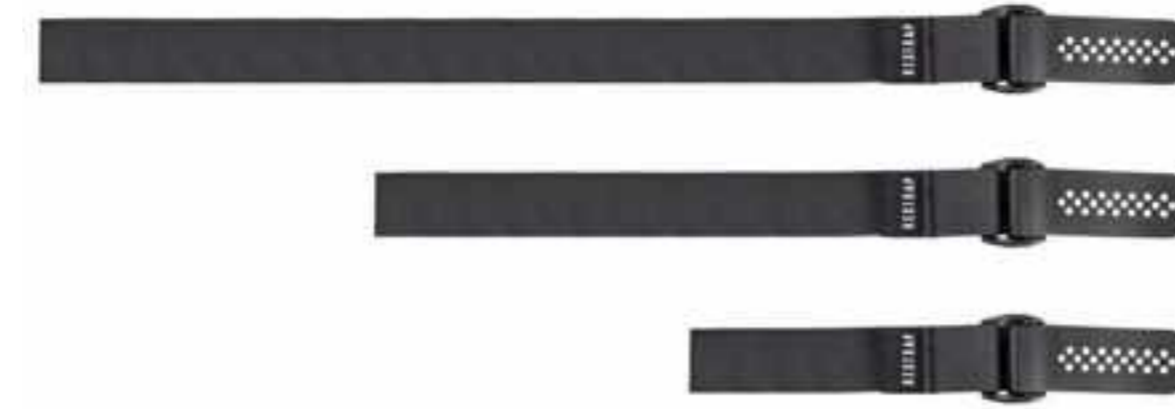

Orange Fast Straps Mix Pack

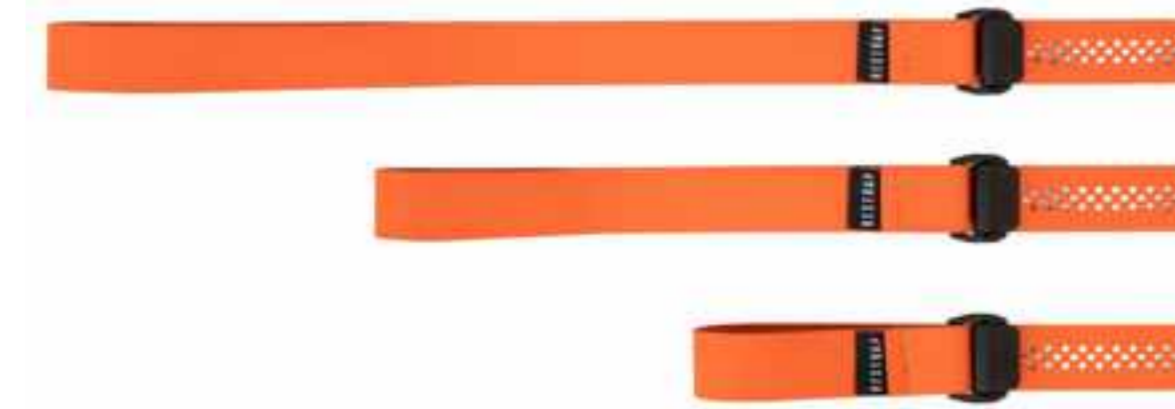

Small Fast Strap



Medium Fast Strap



Large Fast Strap

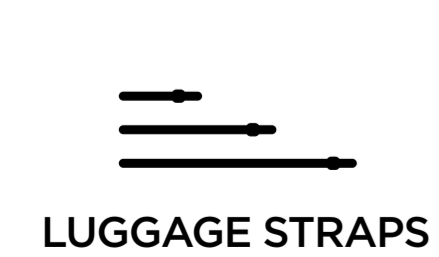



## DIAGONAL PEDAL STRAPS

Page 46

The first ever Restrap product is still going strong. Made from reclaimed seatbelt webbing, the straps benefit from a 3 layer Velcro system, holding your foot firmly in place thanks to a unique twist-tension system. Reinforced eyeleted mounting holes and nickel-plated fittings provide unbeatable strength.

### TECHNICAL DETAILS

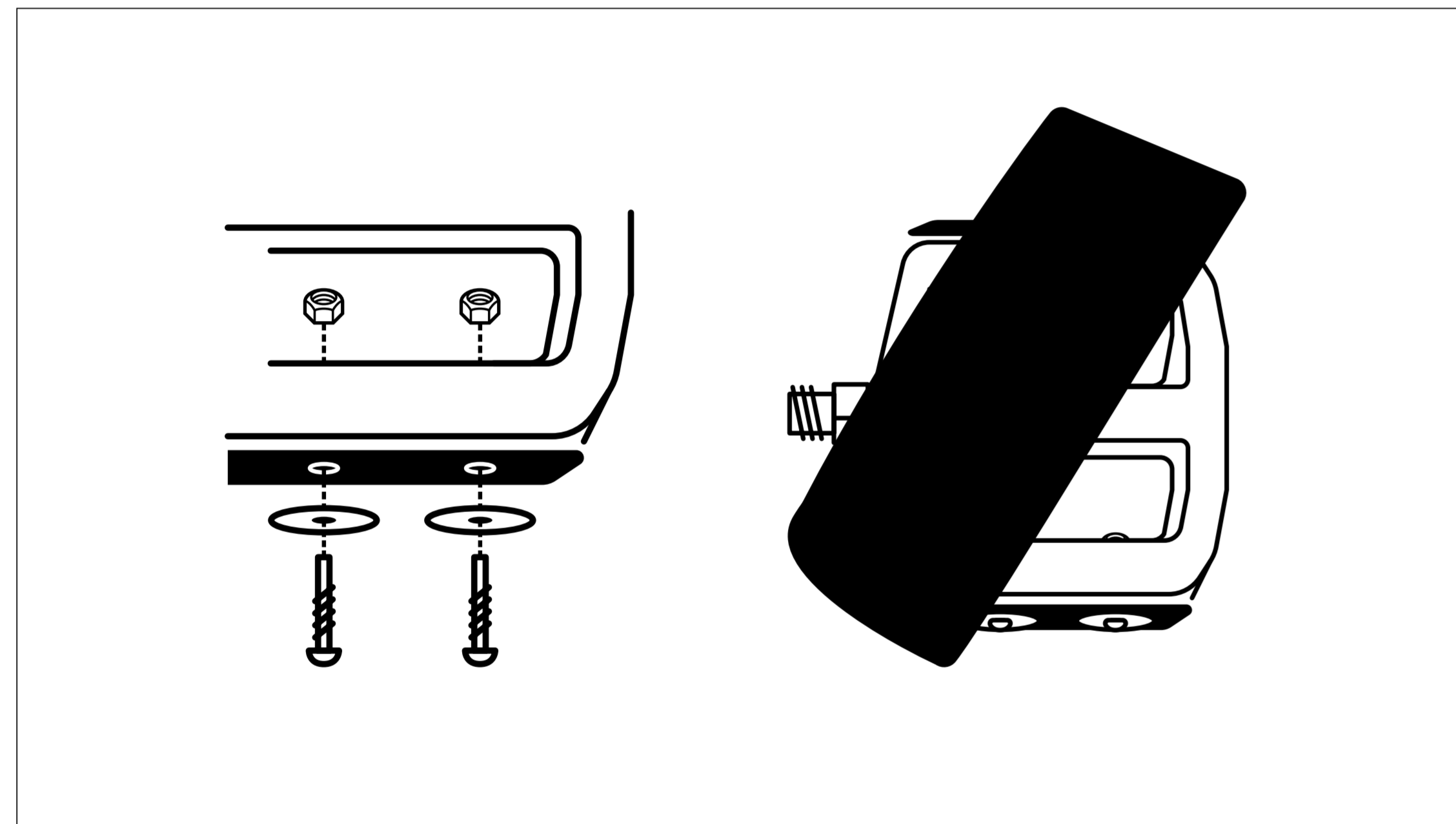

Materials	<b>Strap:</b> Reclaimed Nylon Seatbelt Webbing <b>Fittings:</b> Nickel Plated
Weight	160g
Product Codes	<b>Black</b> - RS_DIA_STD_BLK <b>Red</b> - RS_DIA_STD_RED
HS Code	63079098

Black Diagonal Pedal Strap



Red Diagonal Pedal Strap



PEDAL STRAPS

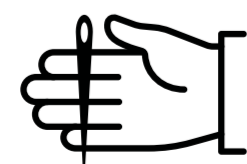

HANDMADE IN UK



LIFETIME WARRANTY



## HORIZONTAL PEDAL STRAPS

Page 47

Restrap horizontal pedal straps provide remarkable strength and comfort. Made from tough nylon webbing, the straps are fully adjustable to suit all riders.

Their unique 3-layer Velcro system holds your foot firmly in place for fast, tough cycling. No fittings required. Just fasten and go.

## TECHNICAL DETAILS

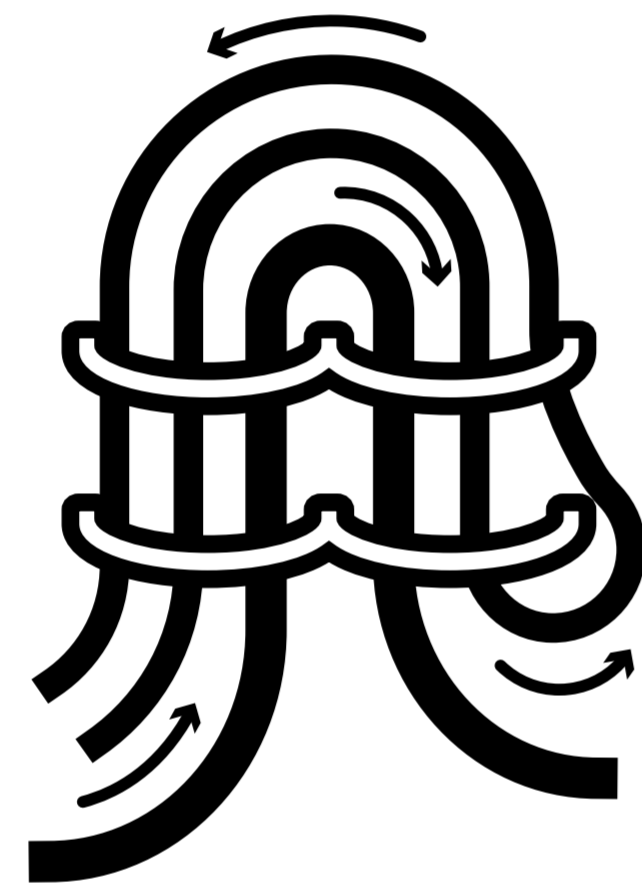

Materials	<b>Strap:</b> Nylon Webbing <b>Fittings:</b> Nickel Plated
Weight	180g
Product Codes	<b>Black</b> - RS_HRZ_STD_BLK
HS Code	63079098

Black Horizontal Pedal Strap



PEDAL STRAPS

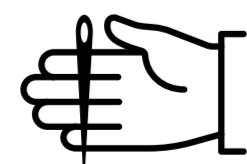

HANDMADE IN UK



LIFETIME WARRANTY



A close-up photograph of a person's hands pouring water from a dark grey pot into a white enamel mug. The scene is set on a mossy log. To the left, a red and silver portable gas stove is lit with a blue flame. In the foreground, there is a clear plastic cup and a box of tea bags. A multi-tool with yellow handles lies to the right of the mug. The mug has the text "HANDMADE IN YORKSHIRE" and "RESTRAP" printed on it. A red tea tag with "YORKSHIRE TEA" is hanging from the mug. The background is a blurred natural setting.

# ACCESSORIES & CLOTHING



## TRAVEL POUCH

Page 49

The Travel Pouch is the perfect small weatherproof pouch for carrying all your essential items on and off your bike. Ideal for storing items like your phone, wallet or other essentials in a jersey pocket, frame bag or backpack, this pouch is designed to keep your belongings safe and secure.

Featuring a YKK Aquaguard zip, a spacious main compartment and internal credit/debit card storage sleeve, the Travel Pouch is easy to access and keeps your items protected from the elements. Made with waterproof TPU fabric outer, orange nylon lining and cushioned foam structure.

Whether you're commuting to work, heading out for a weekend adventure or embarking on a long cycling trip, the Travel Pouch is a must-have accessory that will keep your essentials organized and within easy reach.

Weight - 51g

### TECHNICAL DETAILS

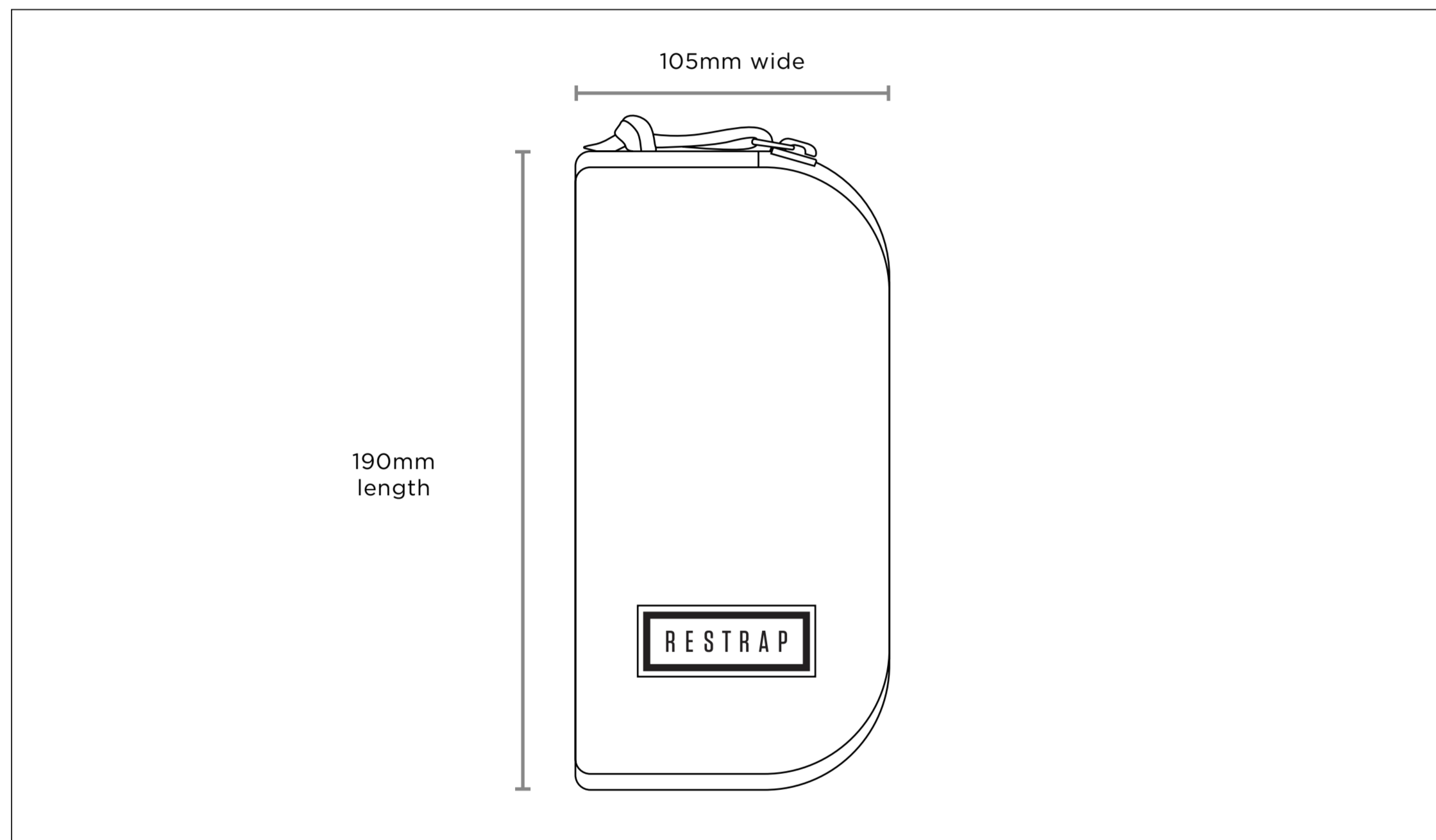

Materials	<b>Body:</b> Waterproof TPU fabric outer, orange nylon lining and cushioned foam structure.
Size	190mm x 105mm x 30mm
Weight	51g
Product Code	RS_TVP_STD_BLK
HS Code	42023290

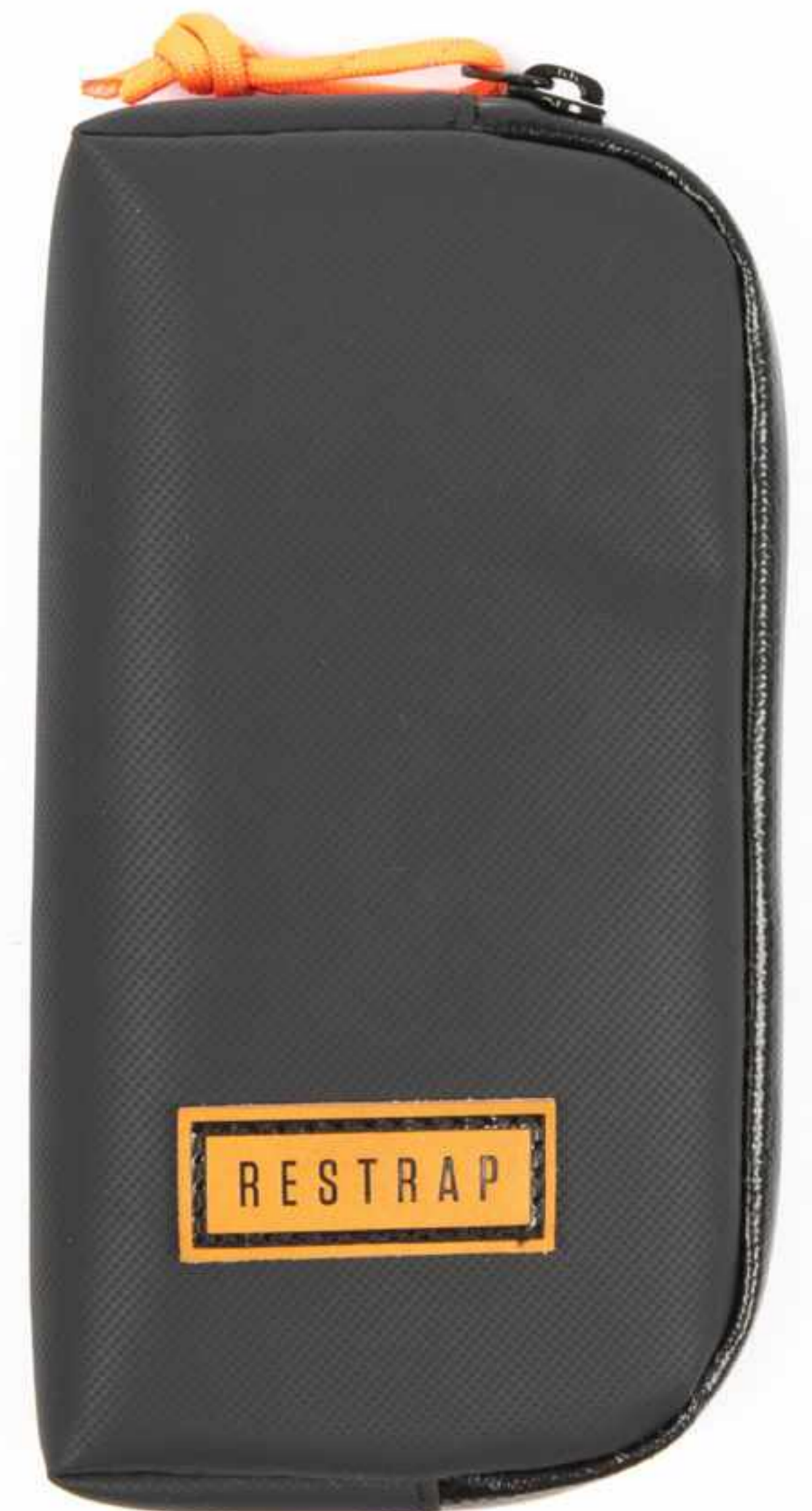

ACCESSORIES

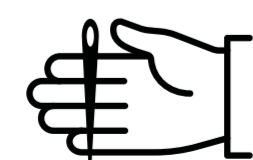

HANDMADE IN UK



LIFETIME WARRANTY



## COFFEE DRIPPER

Page 50

Our portable coffee dripper is the perfect solution for those who love to brew up a coffee on the road.

Three shaped pieces lock together to allow a V60 filter to sit above your mug, using a specially designed shape that always sits centrally and securely while your favourite brew drips through. It then easily packs away and fits into the supplied Textured Nylon pouch, allowing you to comfortably fit this dripper into your bikepacking bags.

\*V60 Size 02 coffee filters not included

Weight: 40g

### TECHNICAL DETAILS

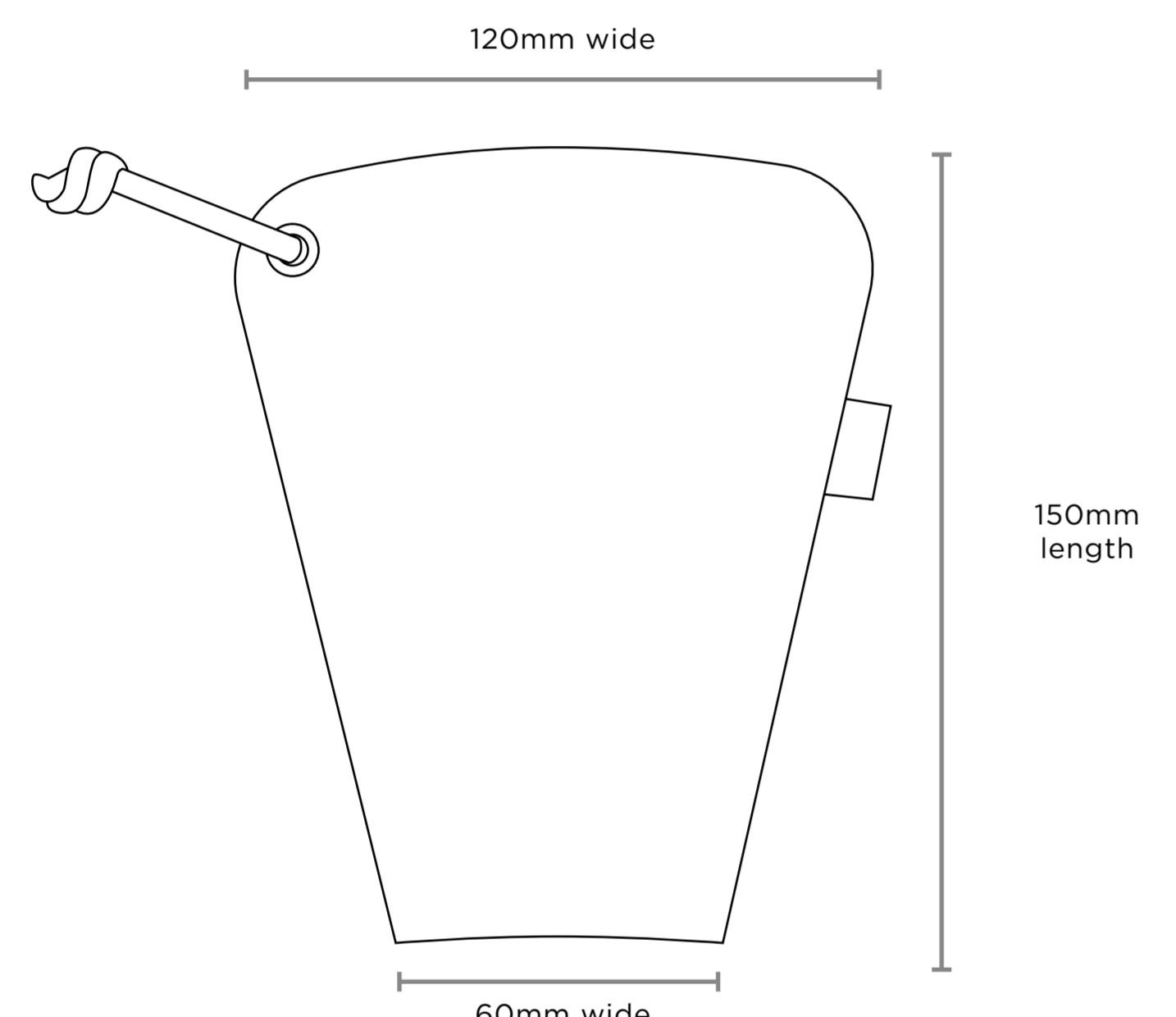
	
Materials	<b>Body:</b> Polypropolene <b>Pouch:</b> 1000D Textured Nylon
Size	120mm (Top) x 60mm (Bottom) x 150mm
Weight	40g
Product Code	RS_CFE_DRP_BLK
HS Code	8516710000



ACCESSORIES

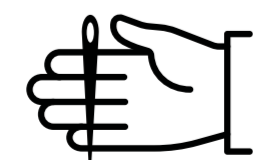

HANDMADE IN UK



## QUOC X RESTRAP SANDALS

Page 51

The QUOC x RESTRAP Sandal is a collaboration that unites two British brands with over two decades of footwear innovation and bikepacking experience between them. Handmade in the UK, it exists to bridge comfort and style with functionality and adventure.

The QUOC X Restrap Sandal is designed as the ultimate post-ride slip-on, combining casual comfort with minimalist elegance, with a flair of functionality.

The sandal features an anatomically designed footbed, with excellent cushioning and arch shaping. It's grippy anti-slip tread makes it perfectly suited for those relaxed hours after a long day in the saddle, whether it be a woodland campsite, a night in the hammock by the beach or exploring around town.

The extra-thick webbing straps work with QUOC's signature microfibre to fasten over your saddle bag with a locking buckle, allowing for quick and convenient carrying while on a long tour, saving packing space in your bikepacking bags. With Restrap's innovative shaping and bonding, these straps are strong, durable and provide maximum comfort while allowing full adjustability for the perfect fit.

Materials	<b>Body:</b> Microfibre <b>Sole:</b> EVA <b>Webbing:</b> Nylon <b>Label:</b> Silicone
Size	EU38-EU47
Product Code	<p><b>Black EU38 / UK4 / US5</b> - QSSD23L-BL-38  <b>Black EU39 / UK5 / US6</b> - QSSD23L-BL-39  <b>Black EU40 / UK6 / US7</b> - QSSD23L-BL-40  <b>Black EU41 / UK7 / US8</b> - QSSD23L-BL-41  <b>Black EU42 / UK7.5 / US8.5</b> - QSSD23L-BL-42  <b>Black EU43 / UK8.5 / US9.5</b> - QSSD23L-BL-43  <b>Black EU44 / UK9.5 / US10.5</b> - QSSD23L-BL-44  <b>Black EU45 / UK10 / US11</b> - QSSD23L-BL-45  <b>Black EU46 / UK11 / US12</b> - QSSD23L-BL-46  <b>Black EU47 / UK11.5 / US12.5</b> - QSSD23L-BL-47</p> <p><b>Sand EU38 / UK4 / US5</b> - QSSD23L-SD-38  <b>Sand EU39 / UK5 / US6</b> - QSSD23L-SD-39  <b>Sand EU40 / UK6 / US7</b> - QSSD23L-SD-40  <b>Sand EU41 / UK7 / US8</b> - QSSD23L-SD-41  <b>Sand EU42 / UK7.5 / US8.5</b> - QSSD23L-SD-42  <b>Sand EU43 / UK8.5 / US9.5</b> - QSSD23L-SD-43  <b>Sand EU44 / UK9.5 / US10.5</b> - QSSD23L-SD-44  <b>Sand EU45 / UK10 / US11</b> - QSSD23L-SD-45  <b>Sand EU46 / UK11 / US12</b> - QSSD23L-SD-46  <b>Sand EU47 / UK11.5 / US12.5</b> - QSSD23L-SD-47</p>
HS Code	6403190000



CLOTHING



HANDMADE IN UK



## HIKE A BIKE HARNESS

Page 52

Whether you're tackling steep mountain trails or rugged terrain off road, this harness is designed to make your journey easier and more enjoyable.

The Hike-a-bike Harness is quick and easy to fit to most bikes, allowing you to go from carrying your bike to riding in a matter of seconds. When it's time to walk your bike up tough hike-a-bike terrain, the harness lets you do so hands-free whilst staying well-balanced.

Designed to not interfere with your riding, the adjustable mounting points and lightweight design allows you to tailor the harness to fit your bike. Included are two retention straps and a long fast strap to secure the front wheel in place.

Made from robust TPU coated Nylon, finished with vegan friendly PU Restrap Label.

## TECHNICAL DETAILS

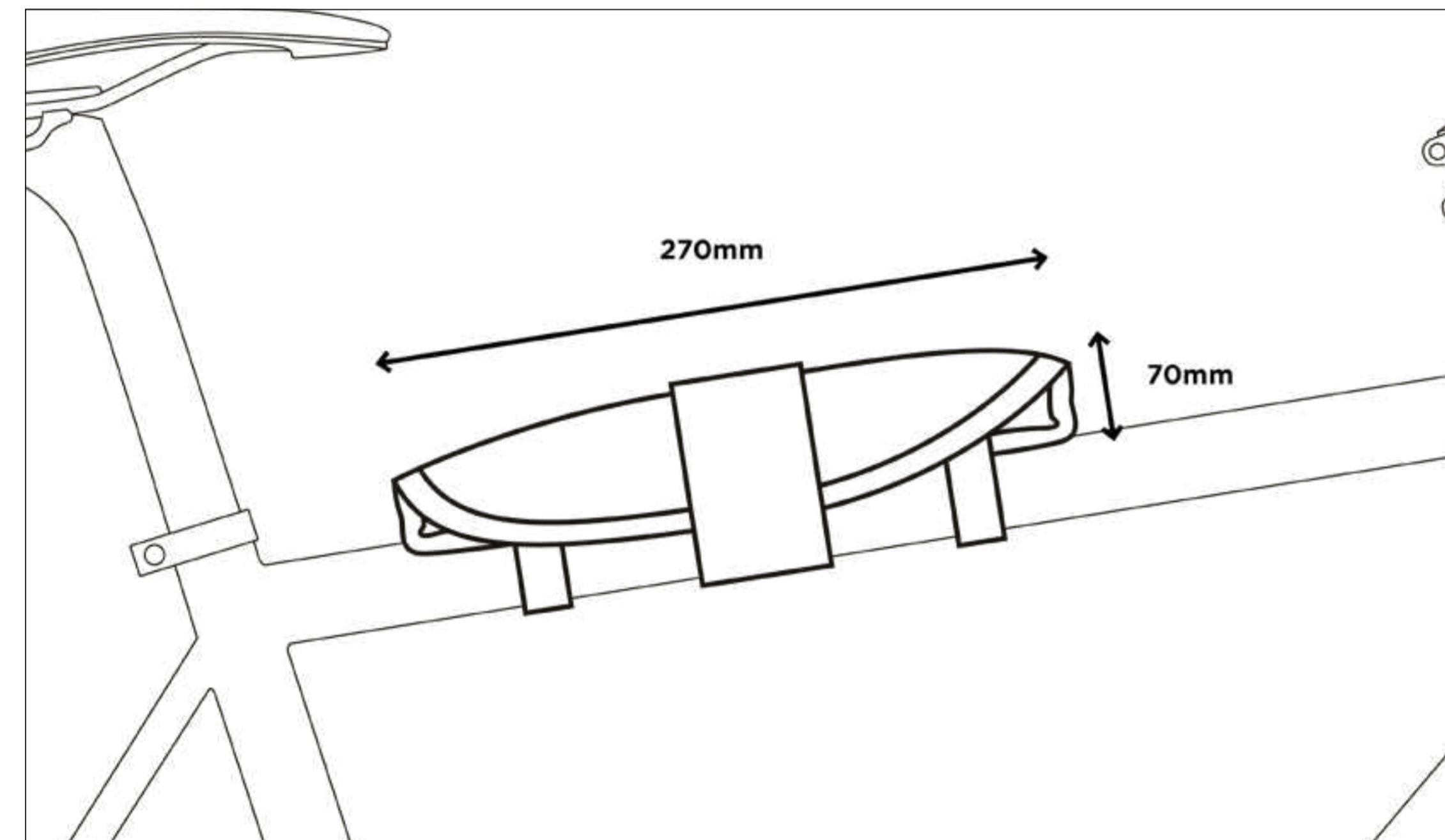

Materials	<b>Body:</b> TPU Coated Nylon <b>Straps:</b> Hypalon
Size	270mm x 70mm x 70mm
Weight	235g
Product Code	RS_HBH_STD_BLK
HS Code	4202921100



ACCESSORIES

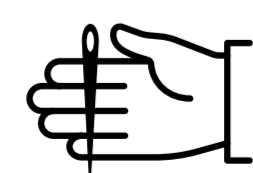

HANDMADE IN UK



LIFETIME WARRANTY





## MUSETTE BAG

Page 53

Musette Bag - Black

The Restrap musette bags are ideal for both on and off the bike. Made from waterproof 1000D cordura and lined with Oxford nylon, they are stylish, durable and reliable. Double popper fasteners keep everything secure, whilst an adjustable shoulder strap tailors the bag to any user.

Hand made in our Yorkshire workshop, all bags are finished with the classic Restrap label.

### TECHNICAL DETAILS

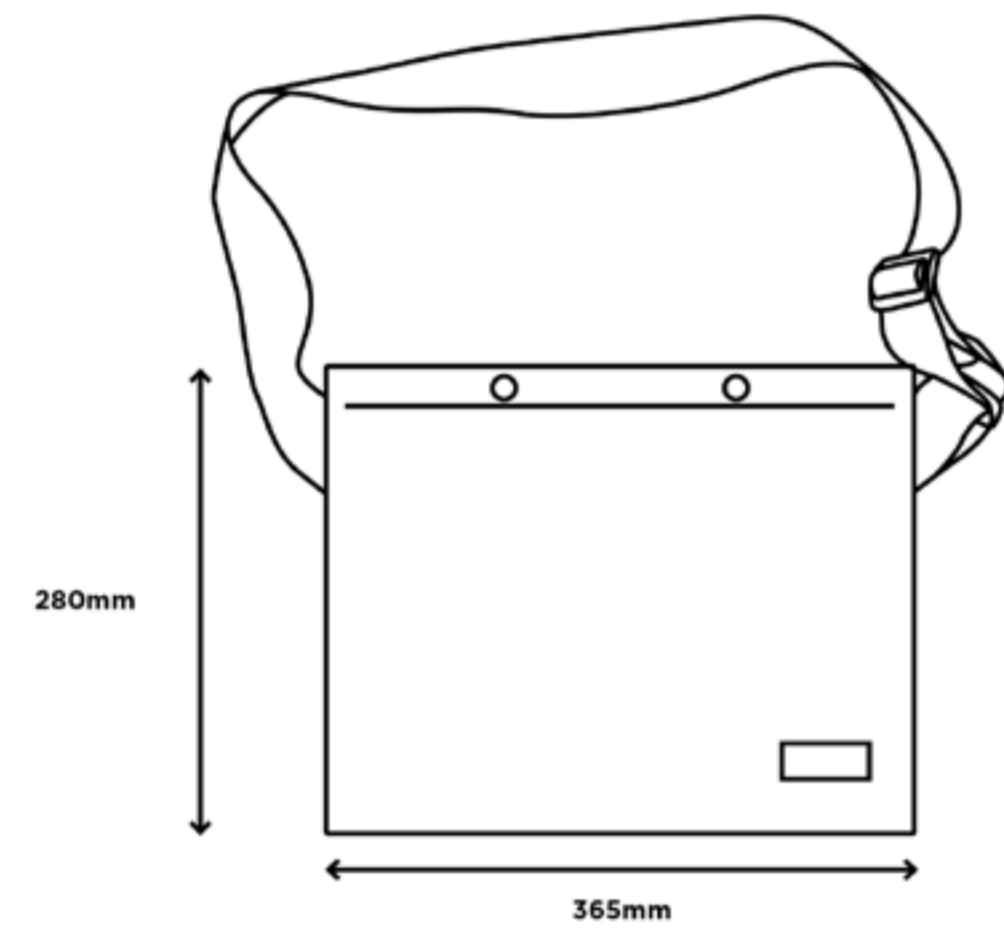

Materials	<b>Body:</b> Polyester Laminate <b>Lining:</b> Oxford Nylon <b>Webbing:</b> Nylon
Size	H29cm x W36cm
Weight	250g
Product Codes	<b>Black</b> - RS_MUS_STD_BLK
HS Code	42029291

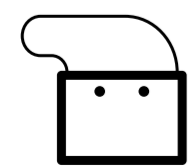

ON-BODY BAGS

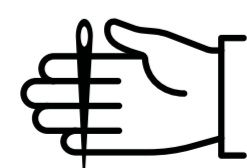

HANDMADE IN UK



LIFETIME WARRANTY



## LAPTOP SLEEVES

Page 54

Laptop Sleeve

The Restrap Laptop sleeve was designed as a safe way to transport your laptop to work (or while bike-touring) in the Large Pannier.

The easy-to-use clip system snaps the laptop sleeve into the back of the Large Pannier backing inside the bag. The clip system holds the padded sleeve flat against the hard back of the pannier and above the bottom of the bag so that it is protected from the ground in-case of any accidents.

This sleeve doesn't have to be used in our Large Pannier either, you can put it into any backpack that can fit it's width or simply use it as protection when carrying it by hand. Contains accessory pocket to divide your computer and charging cable/plug-ins.

Hand made in our Yorkshire workshop, all bags are finished with the classic Restrap label, made from vegan-friendly PU.

Fits up to a 13inch Macbook Pro (230mm x 320mm)

## TECHNICAL DETAILS

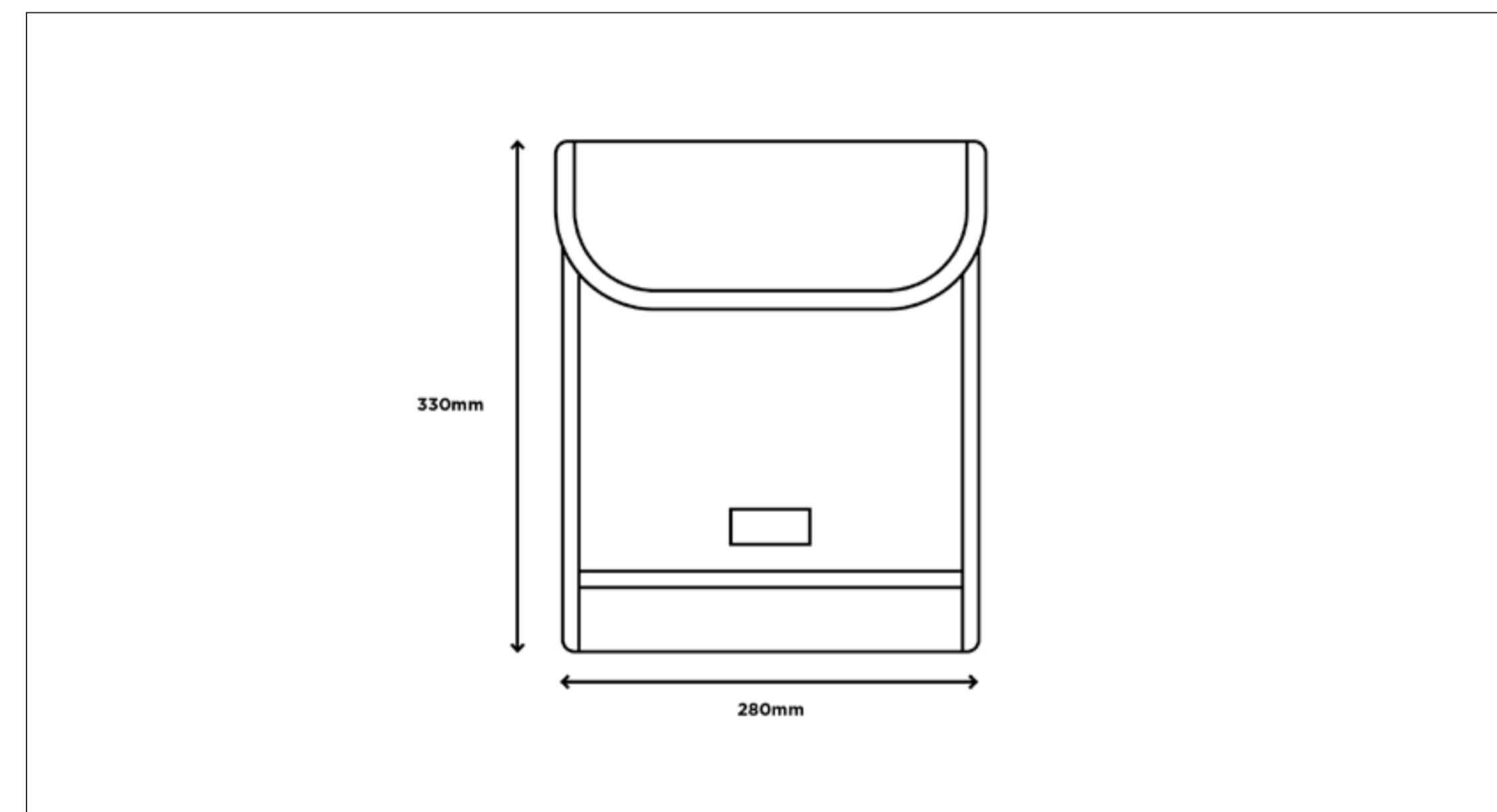

Materials	<b>Body:</b> Waterproof Polyester Laminate <b>Lining:</b> PU Coated Nylon <b>Webbing:</b> Nylon
Size	<b>Laptop Sleeve</b> - W28cm x H33cm
Weight	<b>Laptop Sleeve</b> - 288g
Product Codes	<b>Black</b> - RS_LAP_13I_BLK
HS Code	42029291



Front Open



Front Sealed



Back



ACCESSORIES

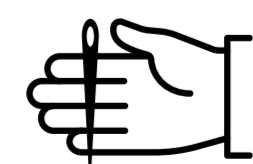

HANDMADE IN UK



LIFETIME WARRANTY



## TOOL ROLL

Page 55

Don't let mechanicals spoil your ride. Carry your tools and spares with ease in the Restrap tool roll. Made from tough Hypalon, the roll contains four tool slots and an elastic strap for any size tube. Spacious yet small, it accommodates a multitool, tyre levers, CO2 cartridges, as well as containing a spare pouch for chain links and other parts. Attach to your saddle rails with an easy-to-use magnetic strap, or slip inside your jersey pocket.

\*Tools not included.

## TECHNICAL DETAILS

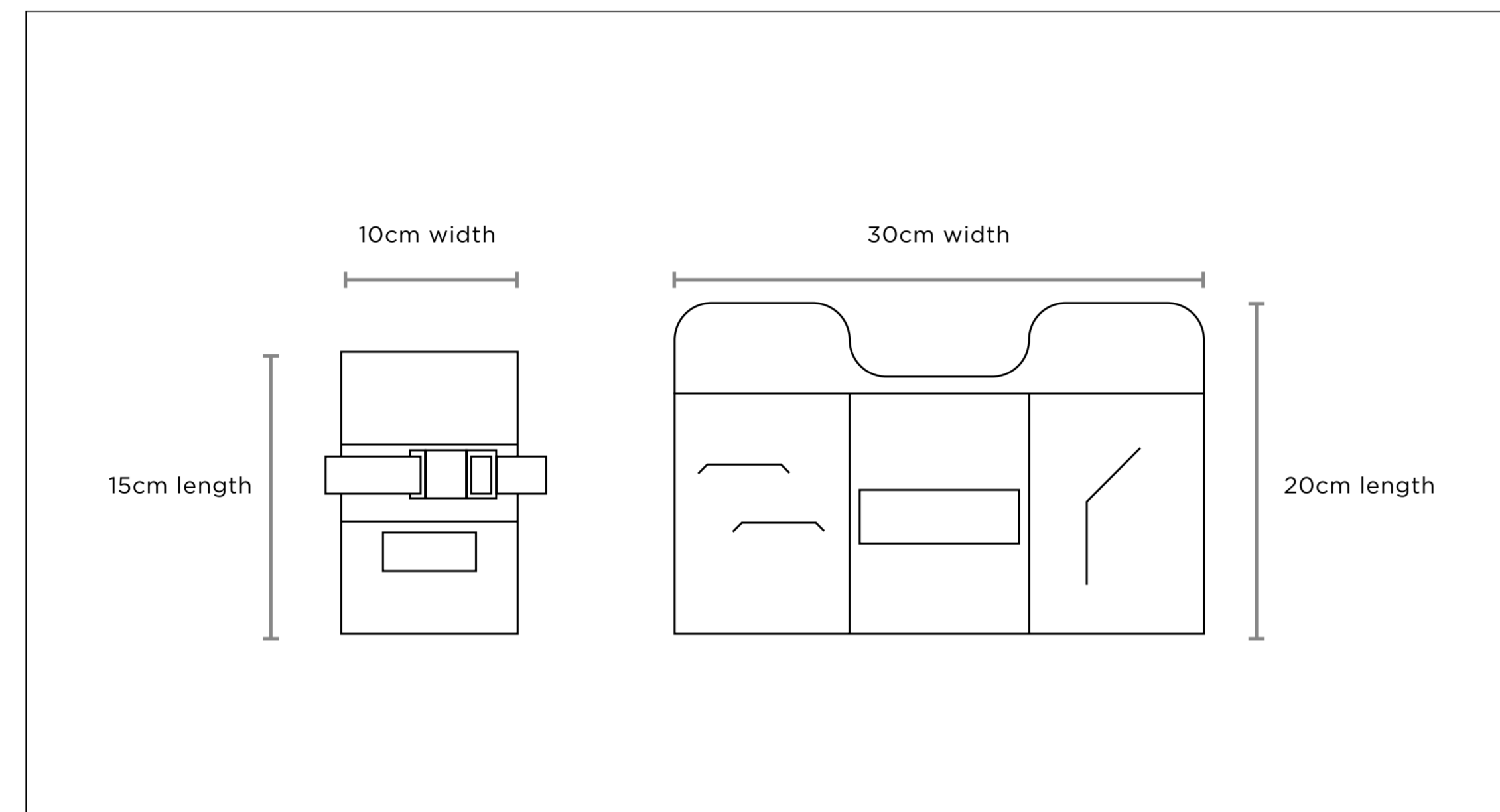

Materials	<b>Body:</b> Hypalon <b>Strap:</b> Elastic Webbing <b>Includes Fidlock Fittings</b>
Size	<b>Folded</b> - W10cm x H15cm <b>Folded Out</b> - W30cm x H20cm
Weight	<b>Tool Roll</b> - 90g
Product Codes	<b>Tool Roll</b> - RS_TRL_STD_BLK
HS Code	42023290

Tool Roll



Mounted to Saddle Rails



ACCESSORIES

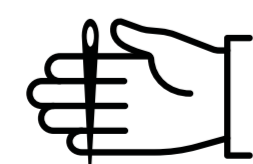

HANDMADE IN UK



LIFETIME WARRANTY



## LINK BELT

Page 56

Link is a one-of-a-kind belt, which offers comfort and flexibility for all kinds of uses.

It contains a unique, Fidlock magnetic buckle. With one single movement, Link can be fastened, removed, loosened and tightened on the go - with just one hand. With a break strength of 50kg and a ladderlock system for size adjustment, Link guarantees flexibility and comfort whilst being exceptionally secure.

The super strength 30mm elastic has been specially manufactured in Great Britain. Its unique design moves with the wearer for added comfort. No more twisting, turning and digging.

## TECHNICAL DETAILS

	
Materials	<b>Material:</b> 30mm Elastic Webbing <b>Buckle:</b> Magnetic Fidlock Buckle
Sizes	<b>S</b> - 26-36" (66-91cm) <b>M</b> - 32-42" (81-106cm) <b>L</b> - 30-50" (101-127cm)
Weight	150g
Product Codes	<b>Small</b> - RS_LNK_SML_BLK <b>Medium</b> - RS_LNK_MED_BLK <b>Large</b> - RS_LNK_LRG_BLK
HS Code	42023290

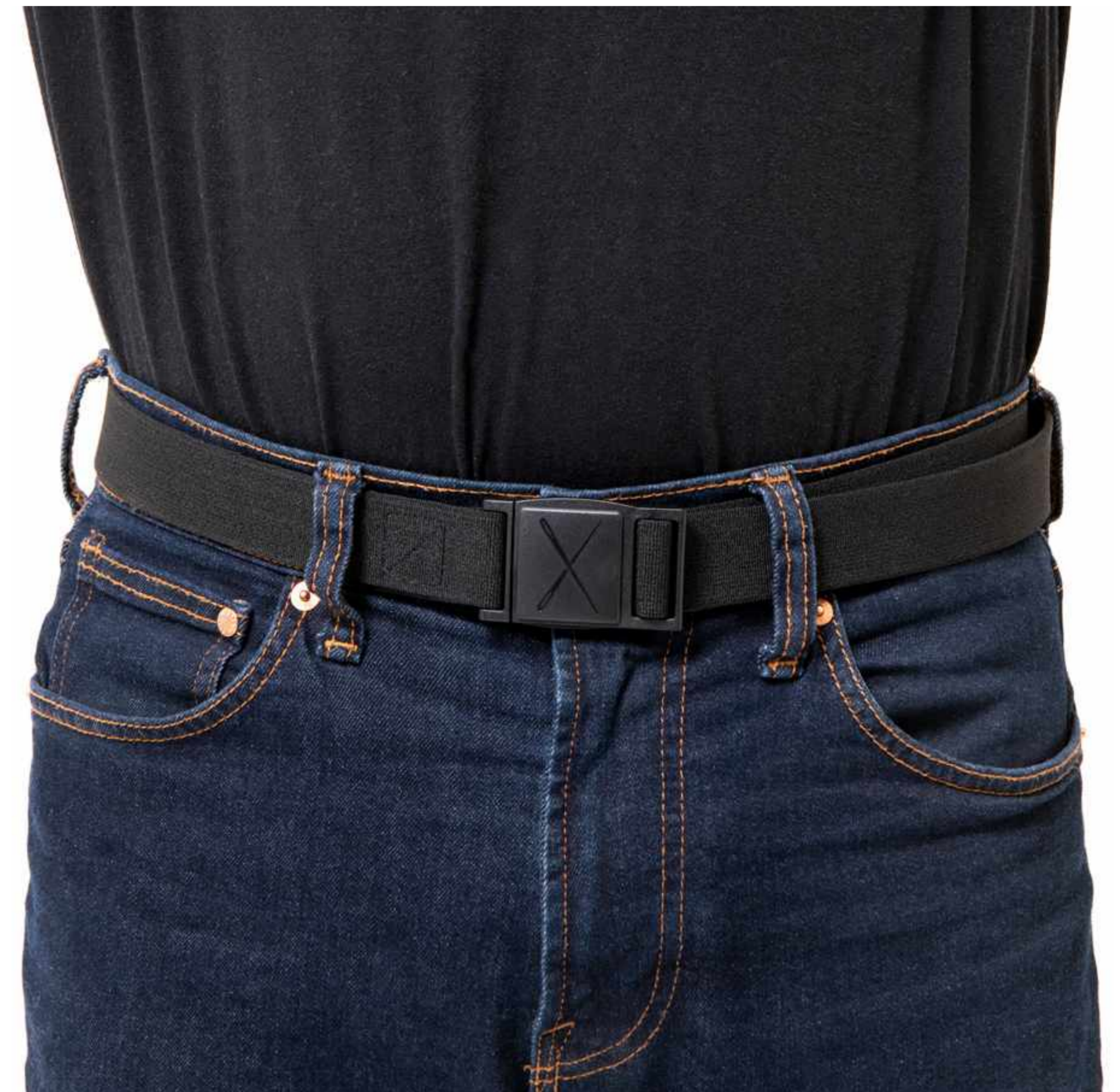

Black Link Belt



CLOTHING

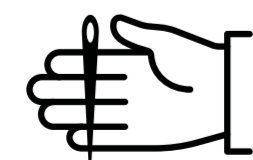

HANDMADE IN UK



LIFETIME WARRANTY



## BICYCLE PROTECTION KIT

Page 57

Bicycle Protection Kit

Vinyl pack to prevent abrasion against dirt, cables and bags. Featuring three sheets of custom cut easy-to-install heavy duty vinyl, this kit provides a variety of shapes to cover and protect areas susceptible to abrasion on any bike. Embellished with a screen printed design of the rugged contours of the Yorkshire Dales, the bicycle protection kit is sure to keep your ride looking fresh for many miles,

### Instructions:

Clean and dry the surface of your bike frame.

Apply vinyl to required areas.

Apply some pressure evenly from the centre pushing outwards to ensure a secure adhesion.

Ride your bike!

Available in Black or White on Clear Tape

## TECHNICAL DETAILS

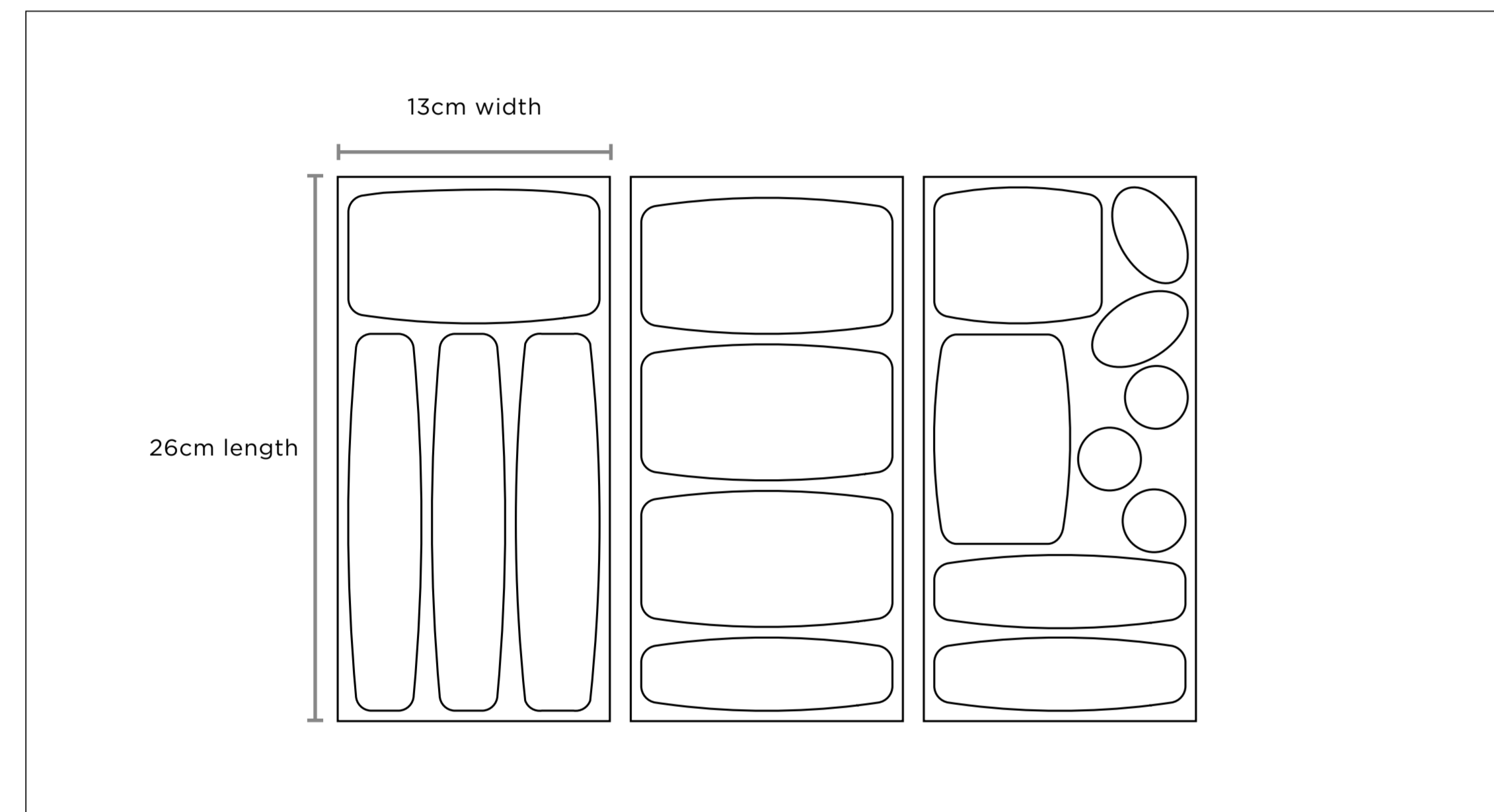

Materials	<b>Vinyl:</b> Soft 200micron PVC Film
Size	<b>Sheet</b> - W13cm x H26cm <b>Pack</b> - W14cm x H29cm
Weight	<b>Bicycle Protection Kit</b> - 75g
Product Codes	<b>Black</b> - RS_BPK_STD_CLR <b>White</b> - RS_BPK_STD_WHT
HS Code	3919909000



Easy to Install



Available in White or Black

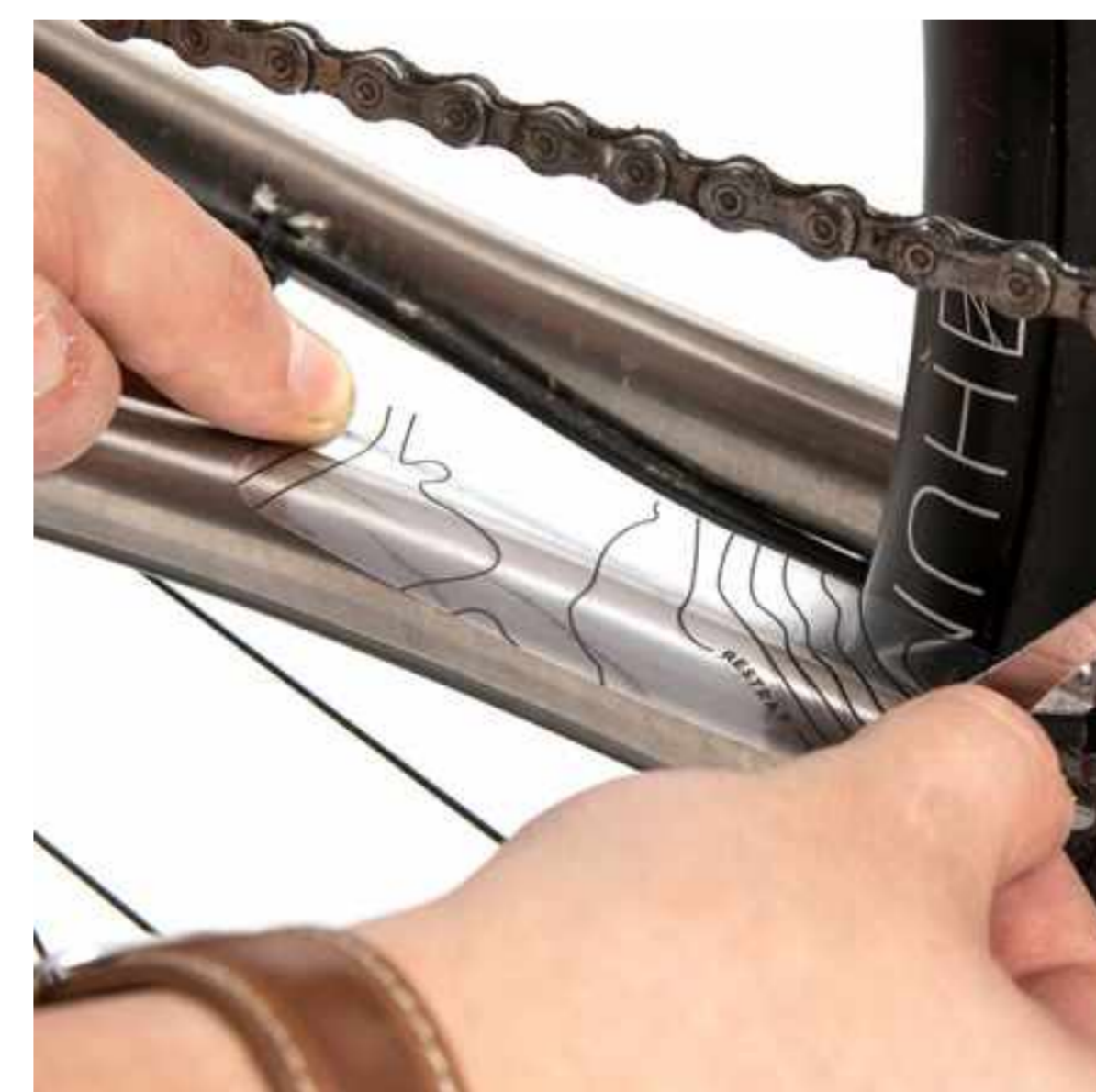

Protects Frame



ACCESSORIES

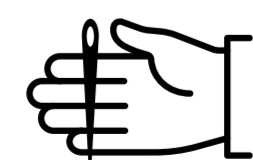

HANDMADE IN UK



## TYRE BOOT KIT

Page 58

The Tyre Boot Kit is a cyclist's must-have if it all goes wrong. The kit features 8 varied cuts of thin, durable and tear-resistant rubberised material, specifically designed to patch rips and tears on any tubed tyre. Think of it as tyre insurance.

A tube of glue is included to help mend the trickiest of rips or tears in your tyre's surface. Supplied as a minimal pack-friendly design to fit in the smallest of spaces on your bike.

### Instructions:

- 1) Locate the affected area on your tyre
- 2) Make sure the area where you wish to apply the patch is as clean as possible
- 3) Apply glue to the patch
- 4) Place patch over the affected area, ensuring full coverage
- 5) Insert tube and re-inflate tyre
- 6) Breathe a sigh of relief and continue on your journey\*

\*The Tyre Boot Kit is designed to save your bacon but it isn't a permanent fix. A torn tyre should be replaced as soon as possible.

## TECHNICAL DETAILS

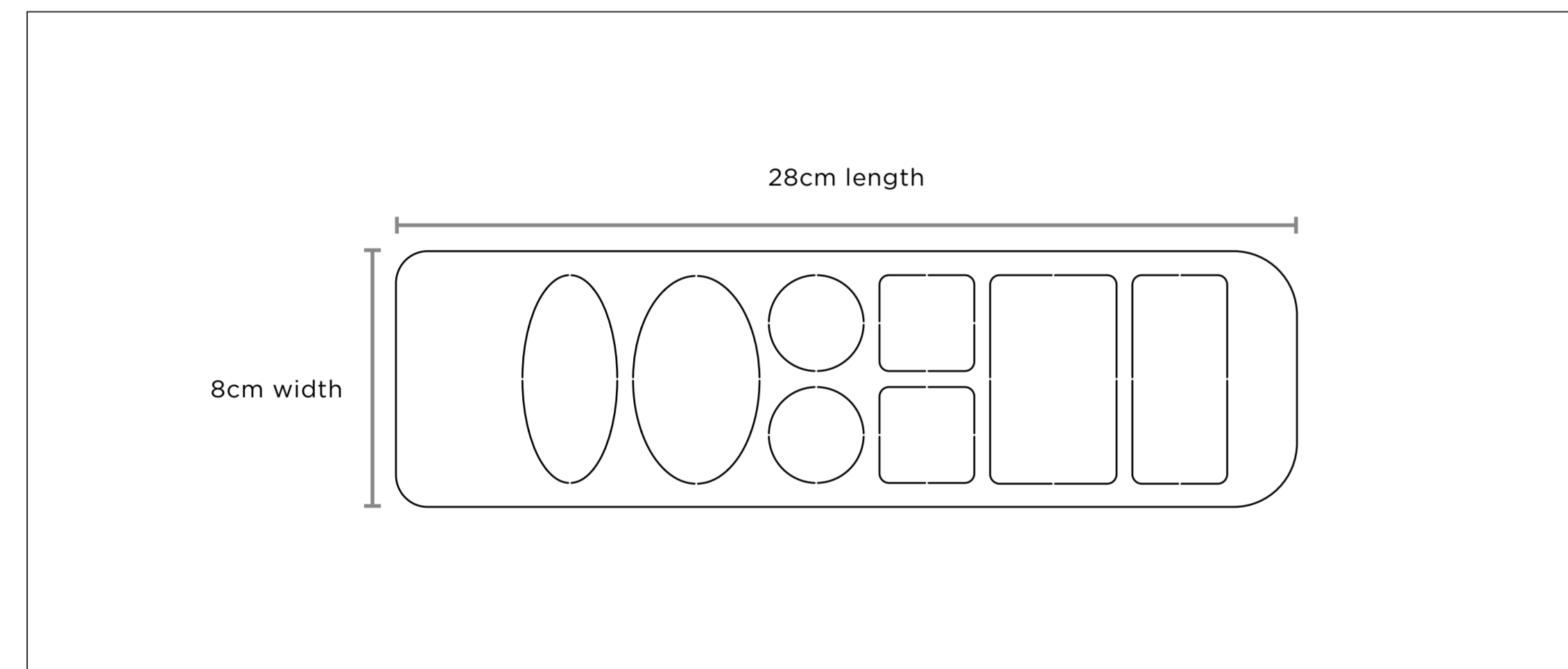

Materials	<b>Body:</b> Hypalon <b>Strap:</b> 20mm Velcro <b>Glue:</b> Plastic, Ethyl, Cyanoacrylate
Size	<b>Unrolled</b> - W8cm x L28cm <b>Rolled</b> - W8cm x L2cm
Weight	<b>Tyre Boot Kit</b> - 18g
Product Codes	<b>BLACK</b> SKU - RS_TBK_STD_BLK <b>ORANGE</b> SKU - RS_TBK_STD_ORA
HS Code	8714103000



ACCESSORIES

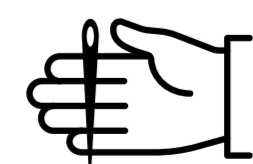

HANDMADE IN UK



## BUMPER BAR

Page 59

The Bumper Bar is a unique accessory that serves multiple functions; as a hard point for mounting lights, while also acting as a spacer for our range of bar bags, pushing them upwards and away from the front wheel. This is ideal for smaller bikes with a low stack height or where handlebar to tyre clearance is limited.

Made from high-strength steel with a durable powder coated finish, the Bumper Bar includes a front grille and 30mm slots on the top and bottom that work seamlessly with the retention straps of our bar bags. Also included are 5mm diameter holes on the top and bottom for additional mounting options.

The front is curved to allow the fitting of most lights, where the position out the front of the steerer is ideal for forward visibility.

The Bumper Bar acts as a 3mm headset spacer and comes in two sizes to fit 1-1/8" or 1-1/4" steerers.

## TECHNICAL DETAILS

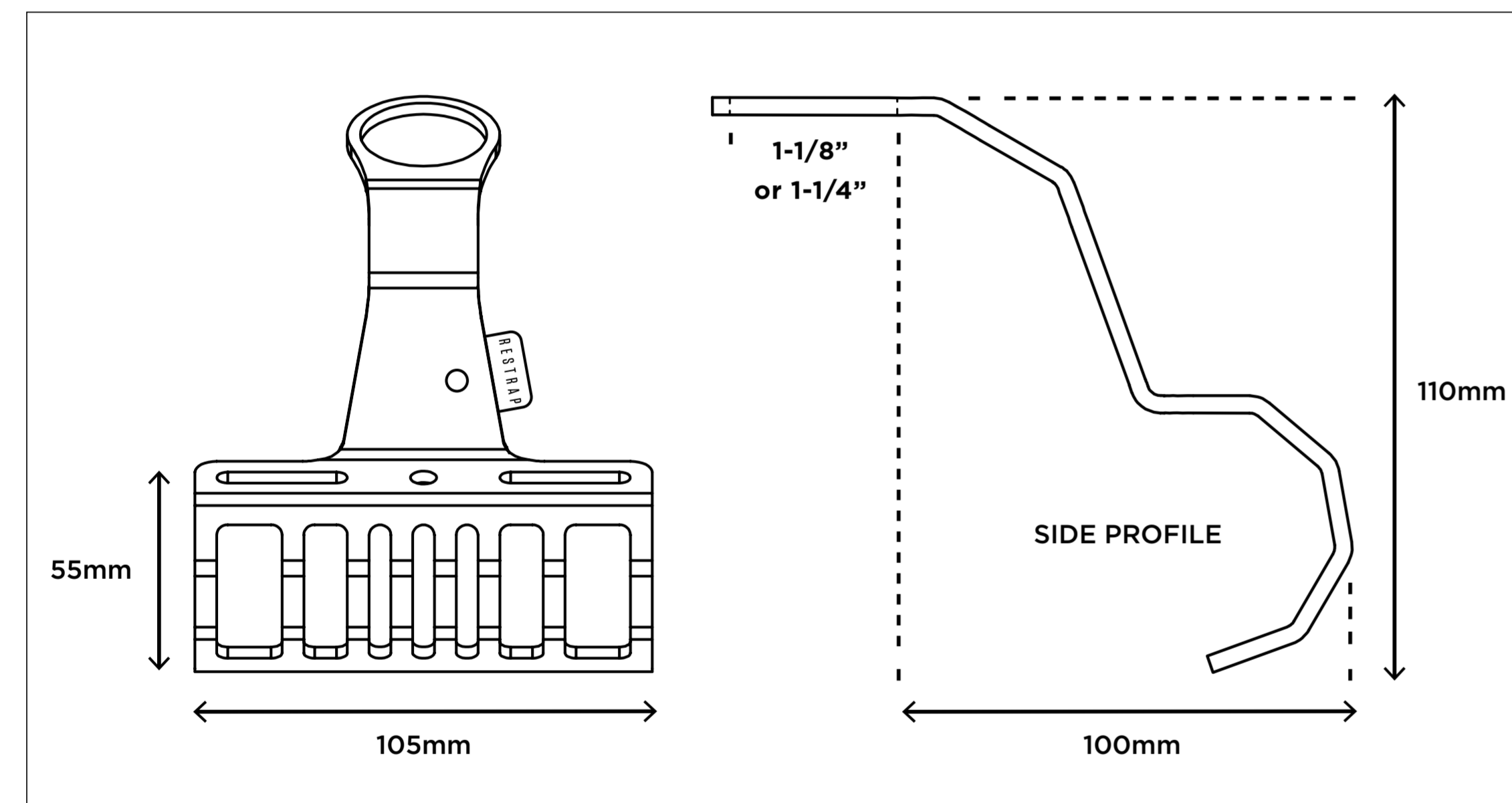

Materials	<b>Body:</b> High Strength Steel <b>Finish:</b> Black Powder Coating
Size	105mm W x 115mm L x 120mm D
Weight	180g
Product Codes	<b>1-1/8":</b> RS_HDW_BMP_BLK <b>1-1/4":</b> RS_HDW_BM4_BLK
HS Code	8714993000

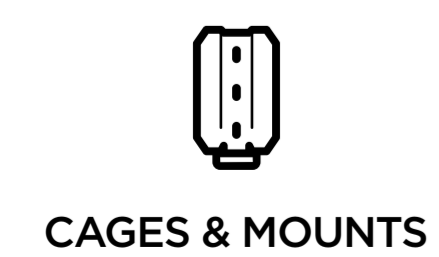



## LOCK HOLSTER

With the Restrap lock holster you can carry any D-lock securely and discreetly. Fully elasticated, the holster loops easily on to any belt and goes subtly unnoticed when empty.

With double-layer elastic, your lock will stay firmly in place even during the roughest of rides.

## TECHNICAL DETAILS

Page 60

Materials	<b>Strap:</b> Recycled Nylon Seatbelt Webbing and Double Layer Elastic
Fitting	Most D-Locks
Weight	30g
Product Codes	RS_LHR_STD_BLK
HS Code	63079098



## KEY CLIP

Never lose your keys again with the military-grade Restrap clip.

Connected to a carbon-fibre loop and secured with nylon webbing, you can carry your keys with confidence.

## TECHNICAL DETAILS

Materials	<b>Webbing:</b> Nylon <b>Ring:</b> Carbon-fibre spacer <b>Fitting:</b> Machine Gun Clip
Weight	56g
Product Codes	RS_KCP_STD_BLK
HS Code	63079098



## BOTTLE HOLSTER

Cycling is thirsty work. The Restrap bottle holster enables you to carry bottles of any size from your belt, with unfailing comfort and security.

Made from recycled seatbelt, the holster loops on to any belt and contains a pull cord for guaranteed stability.

## TECHNICAL DETAILS

Materials	<b>Strap:</b> Recycled Nylon Seatbelt Webbing and Double Layer Elastic
Fitting	Up to 750ml Bottles
Weight	56g
Product Codes	RS_BLH_STD_BLK
HS Code	63079098

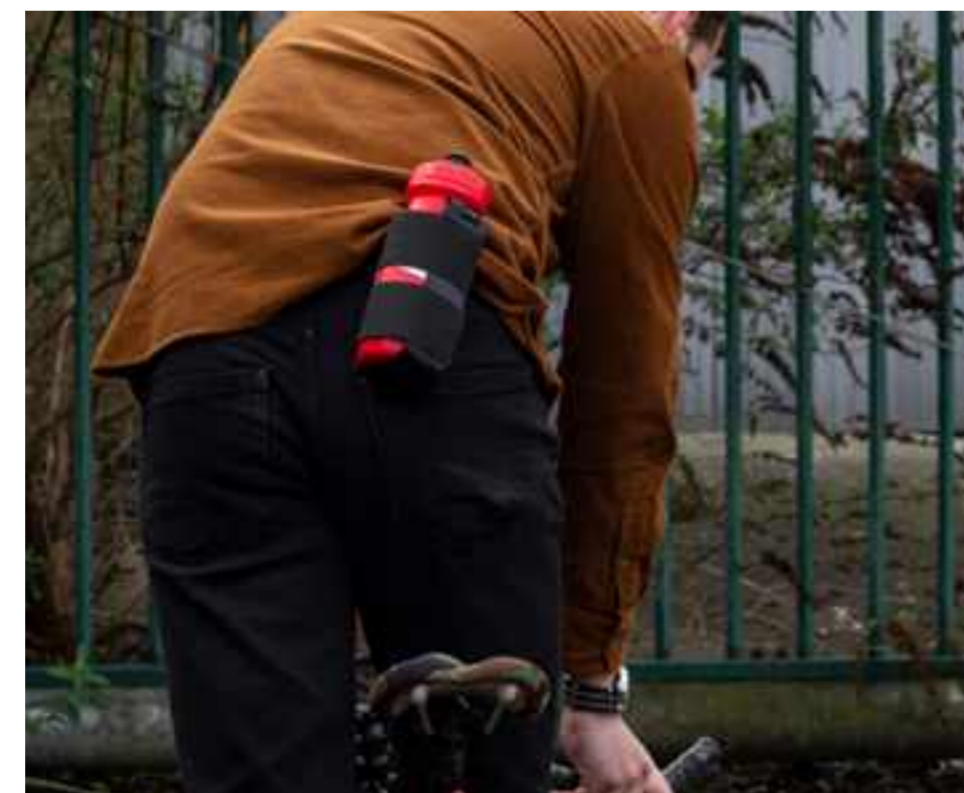

## WALLET

Smart, understated and practical, our new wallet represents Restrap's three trademark qualities. Its unique laser-cut design provides secure storage, whilst the elasticated closure expands easily for cash or receipts and cards.

Made from hard-wearing Hypalon, the wallet's casing is waterproof and impossible to tear. Handmade, as always, in Yorkshire.

## TECHNICAL DETAILS

Materials	<b>Body:</b> Hypalon <b>Strap:</b> Elastic Webbing
Size	H10cm x W8cm
Weight	60g
Product Code	RS_WAL_STD_BLK
HS Code	42023290





## RESTRAP T-SHIRTS

Page 61

A design depicting everything that embodies Restrap; from producing everything in-house to bikepacking through the mountains.

Our T-shirt is screen printed, by hand in Yorkshire, on a premium black Gildan Hammer T-shirt to stand the test of time.

100% cotton, 203 g/m<sup>2</sup>

Unisex Sizes: Small to Extra Large

## TECHNICAL DETAILS

Sizes	Small, Medium, Large, X-Large
Product Codes	<p><b>T-shirt - Small - RS_SST_SML_BLK</b>  <b>T-shirt - Medium - RS_SST_MED_BLK</b>  <b>T-shirt - Large - RS_SST_LRG_BLK</b>  <b>T-shirt - Extra Large - RS_SST_XLG_BLK</b></p> <p><b>Longsleeve T-shirt - Small - RS_LST_SML_BLK</b>  <b>Longsleeve T-shirt - Medium - RS_LST_MED_BLK</b>  <b>Longsleeve T-shirt - Large - RS_LST_LRG_BLK</b>  <b>Longsleeve T-shirt - Extra Large - RS_LST_XLG_BLK</b></p>
HS Code	610910000



CLOTHING

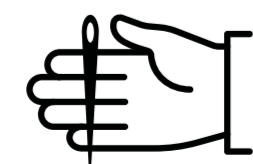

HANDMADE IN UK



## T-SHIRTS

Page 62

Our classic Restrap tee has been a popular product since its launch. Bearing the Restrap logo, all our T-shirts are printed right here in Yorkshire and are now available in Navy and White. In addition to this we have the carryeverything t-shirt in Black, the Bikepacking t-shirt in Grey and our newest Will Travel For Gravel in Black.

100% Cotton

### TECHNICAL DETAILS

Sizes	Small, Medium, Large, X-Large
Product Codes	<p><b>BIKEPACKING - SMALL</b> - RS_TBP_SML_GRY  <b>BIKEPACKING - MEDIUM</b> - RS_TBP_MED_GRY  <b>BIKEPACKING - LARGE</b> - RS_TBP_LRG_GRY  <b>BIKEPACKING - XLARGE</b> - RS_TBP_XLG_GRY</p> <p><b>CARRY EVERYTHING - SMALL</b> - RS_TC1_SML_BLK  <b>CARRY EVERYTHING - MEDIUM</b> - RS_TC1_MED_BLK  <b>CARRY EVERYTHING - LARGE</b> - RS_TC1_LRG_BLK  <b>CARRY EVERYTHING - XLARGE</b> - RS_TC1_XLG_BLK</p> <p><b>WHITE LOGO - SMALL</b> - RS_TSL_SML_WHT  <b>WHITE LOGO - MEDIUM</b> - RS_TSL_MED_WHT  <b>WHITE LOGO - LARGE</b> - RS_TSL_LRG_WHT  <b>WHITE LOGO - XLARGE</b> - RS_TSL_XLG_WHT</p> <p><b>NAVY LOGO - SMALL</b> - RS_TSL_SML_NAV  <b>NAVY LOGO - MEDIUM</b> - RS_TSL_MED_NAV  <b>NAVY LOGO - LARGE</b> - RS_TSL_LRG_NAV  <b>NAVY LOGO - XLARGE</b> - RS_TSL_XLG_NAV</p> <p><b>WILL TRAVEL FOR GRAVEL - SMALL</b> - RS_TSG_SML_BLK  <b>WILL TRAVEL FOR GRAVEL - MEDIUM</b> - RS_TSG_MED_BLK  <b>WILL TRAVEL FOR GRAVEL - LARGE</b> - RS_TSG_LRG_BLK  <b>WILL TRAVEL FOR GRAVEL - XLARGE</b> - RS_TSG_XLG_BLK</p>
HS Code	610910000

## CAMP CAPS

Cotton corduroy six panel cap with a soft unstructured crown, cotton twill sweatband, interior taping and adjustable fabric strap with metal buckle and grommet. Restrap needles embroidery and woven label detailing.

### TECHNICAL DETAILS

Materials	Cotton Corduroy with Metal Clasp
Product Codes	<p><b>FOREST GREEN</b> - RS_CAP_CMP_FOR  <b>NAVY</b> - RS_CAP_CMP_NVY    <b>CAMEL</b> - RS_CAP_CMP_CAM</p>
HS Code	650400000

Will Travel For Gravel T-shirt



Bikepacking T-shirt



Logo T-shirt



Carry Everything T-shirt



Camp Caps in Forest Green, Navy and Camel





## 200Z ENAMEL MUG

Page 63

Bike packing and camping are tough activities. Here at Restrap we provide equally tough products that can be carried and used every day without failing.

Our extra large enamel mugs provide a highly durable, easy-clean solution for eating and drinking in the wild as well as a great way to boil water and heat up food. The 80mm diameter base sits comfortably on most stoves and the 90mm internal width is large enough to fit smaller gas-canisters which can be easily secured with a Restrap Fast Strap.

This is a stylish and ideal gift for those who love the outdoors.

Size: 20oz / 568ml (That's right, a pint!)

### TECHNICAL DETAILS

Materials	Enamel Coated Tin
Product Codes	<b>20oz ENAMEL MUG</b> - RS_MUG_TECH_WHT
HS Code	7326904000

## CYCLING CAPS

Our caps feature a screen printed design on a windproof, breathable cotton and polyester blend for maximum comfort all year round. An anti-bacterial, elasticated band keeps things fresh and firmly in place. One size fits most.

### TECHNICAL DETAILS

Materials	Cotton, Polyester, Antibacterial Elastic Band
Product Codes	<b>BLACK</b> - RS_CAP_YKS_BLK <b>ORANGE</b> - RS_CAP_YKS_ORA
HS Code	6504000000

## PATCHES

Represent Restrap wherever you go with our eye-catching patches.

### TECHNICAL DETAILS

Materials	SOMETIMES HIKING - Embroidered Cloth with Bare Backing ALL OTHER PATCHES - Embroidered Cloth with Iron-on Backing
Product Codes	<b>LOSING THE WILL TO HILL</b> - RS_WTH_STD_STD <b>NEVER ENDING DESCENDING</b> - RS_NED_STD_STD <b>WILL TRAVEL FOR GRAVEL</b> - RS_TGP_STD_STD <b>SOMETIMES HIKING</b> - RS_SHAB_STD_OLV
HS Code	5807101000

20oz Enamel Mug



Yorkshire Contours Black Cycling Cap



Losing The Will To Hill Patch  
9cm diameter



Never Ending Descending Patch  
9cm diameter



Yorkshire Contours Orange Cycling Cap

Will Travel For Gravel Patch  
9cm diameter



Sometimes Hiking Patch  
5.5cm diameter





# RESTRAP



[FACEBOOK.COM/RESTRAP](https://www.facebook.com/restrap)



[TWITTER.COM/RESTRAPLTD](https://twitter.com/restrapltd)



[INSTAGRAM.COM/RESTRAP](https://www.instagram.com/restrap)



[YOUTUBE.COM/C/RESTRAPLTD](https://www.youtube.com/c/restrapltd)



[RESTRAP.COM](https://www.restrap.com)

+44 (0) 1132 451 128

[SALES@RESTRAP.COM](mailto:SALES@RESTRAP.COM)

RESTRAP  
UNIT G1, 102 KIRKSTALL ROAD  
LEEDS, WEST YORKSHIRE,  
UNITED KINGDOM, LS3 1JA