



PROCÉDÉS CHÉNEL[®] INTL
Architectures de papiers

2021

CATALOGUE GÉNÉRAL
GENERAL CATALOGUE



CATALOGUE GÉNÉRAL

GENERAL CATALOGUE

SOMMAIRE / CONTENTS

PROCÉDÉS CHÉNEL

QUI? / WHO?	7
LES ENGAGEMENTS RESPONSABLES DE PCI / PCI'S RESPONSIBLE COMMITMENTS	8

LES MATÉRIAUX / THE MATERIALS

DROP PAPER®	14
FLUO DROP®	18
DROP ALACARTE	22
PULP DROP®	26
PERFO DROP	28
DROP JET®	32
EASY DROP®	36
SPARKLE DROP®	38
SILVER DROP®	40
CRISTAL DROP®	42
SILK DROP®	44
KRAFT DROP®	46
DROP NET®	48
STRONG DROP®	50
HARD DROP®	52
TEXTILES ENDUITS	54
TYVEK	58
HONEYCOMB	60
SMOKE OUT®	62
HARU STUCK ON DESIGN	64
DROP CAKE®	66
CRISPY DROP®	68

LES APPLICATIONS / THE APPLICATIONS

PLAFONDS / CEILINGS

Honeycomb ceiling	74
Drop Stripe®	78
Laser Drop®	84
Drop Gondola®	88
Paralume®	96
Smoke Out®	102

CLOISONS / PARTITIONS

Paper Box	108
Honeycomb modules	114
Honeycomb partitions	118

Pipe&Drop®	120
Laser Drop®	126
Lighted wall	132
Grow Up by Flavie+Paul	134
Kirigami by Janique Bourget	136
Airdrop®	138
Igloo	140

LUMINAIRES / LIGHTING

Lighted Drop	144
Light Column	148
Light Modules	152
Laser Light®	154
Daisy by K-now	156
Lampe Canopy	158

MOBILIER / FURNITURE

Honeycomb furniture - tables	162
Honeycomb furniture - comptoirs / Counter	168
Lumibar	170
Drop Seat	174
Stooly	176

ACCESSOIRES / ACCESSORIES

Paper tree	180
Sapins de Noël / ChristmasTrees	182
Guirlandes / Garlands	190
Arch	196
Fleurs / Flowers	198
Rosa	200
Drop Fruits	202
Standing flowers	204
Rocks & Clouds	206
Jelly Fish	208
Fish	210
Dove	212
Photophores	214

ETC.	216
------	-----



PROCÉDÉS CHÉNEL[®] INTL

Architectures de papiers

PROCÉDÉS CHÉNEL INTERNATIONAL est une équipe pluridisciplinaire qui bénéficie de racines professionnelles profondes plus que centenaires. Elle est spécialisée dans la création, le développement et la distribution de matériels et techniques destinés aux concepteurs d'expositions, de l'événementiel et de l'architecture intérieure.

Engagée depuis de nombreuses années dans un processus d'amélioration constante, tant au niveau sociétal qu'environnemental, PROCÉDÉS CHÉNEL INTERNATIONAL est à même de vous offrir des solutions plus responsables pour vos projets.

PROCÉDÉS CHÉNEL INTERNATIONAL: a pluridisciplinary, creative and dynamic team helping designers since 1896 with worldwide development, production and distribution of decorative solutions technologies and materials. Our inspirational range of products is ideal for creative designers to conceive trade or domestic exhibition stands, events, interior architecture...

Committed for years in an always improving process on societal as well as environmental levels, PROCÉDÉS CHÉNEL INTERNATIONAL is able to offer you more responsible solutions for your projects.

70, rue Jean Bleuzen - 92170 Vanves - France
T : +33 (0)1 41 08 76 76 - F : +33 (0)1 41 08 01 53
info@chenel.com - www.chenel.com



LES ENGAGEMENTS RESPONSABLES DE PCI

PCI'S RESPONSIBLE COMMITMENTS

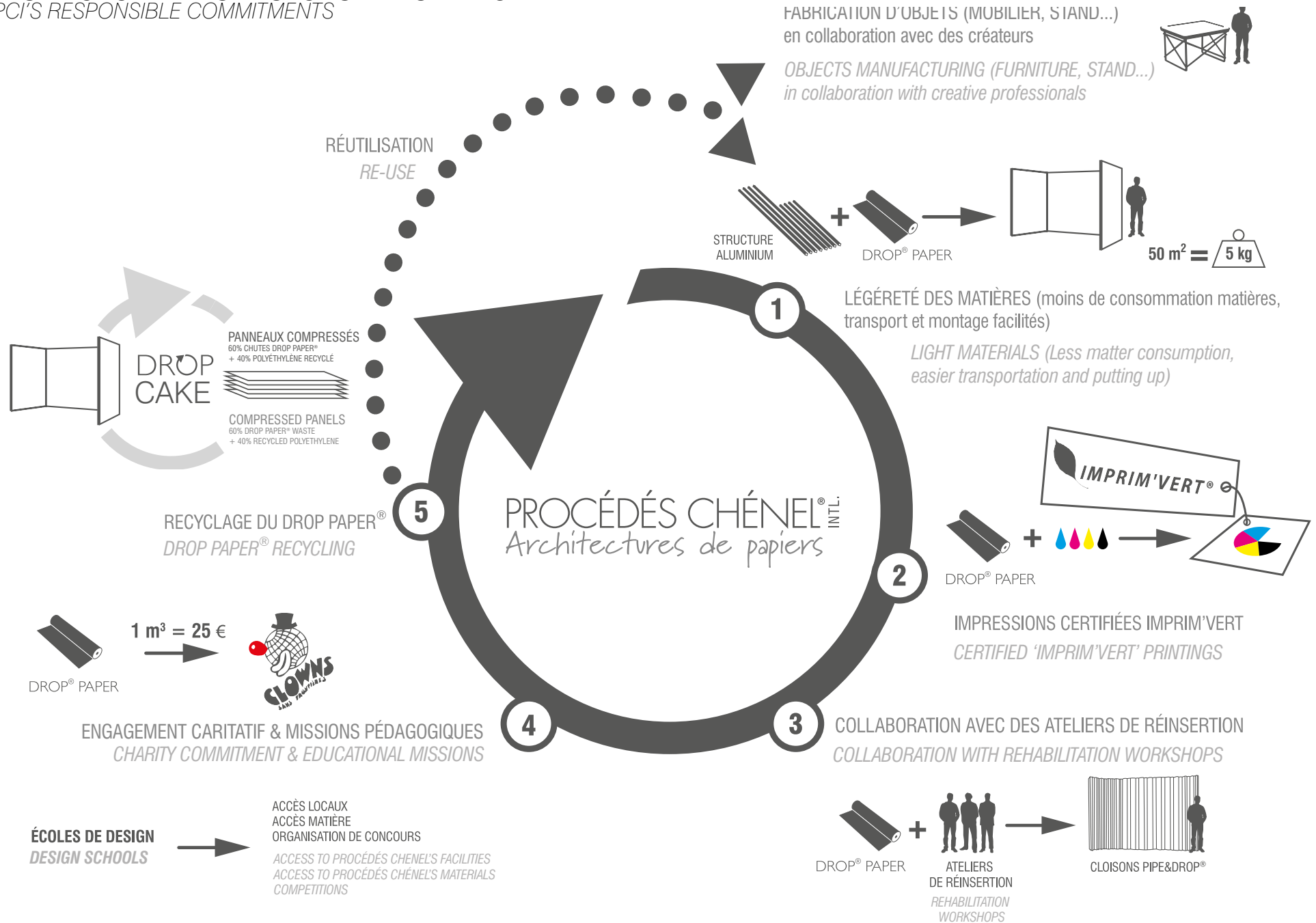



PICTOS

KEYS



Description
Description



Résistance au feu
Fire resistance

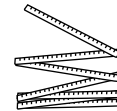

Dimensions
Dimensions



Utilisation
Examples of use



Impression
Printing

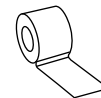

Modes de fixation
Fixing methods



Stockage
Storage



Particularités
Specifics



Durabilité
Durability



LES MATÉRIAUX

THE MATERIALS



D R O P P A P E R
D R O P[®]
 D R O P S C R E E N

Best Booth Award for IBERIA at FITUR / International Tourism Fair in Madrid 2020
 Made by Maxiart & Jesus San Vicente (architect)

D R O P P A P E R
D R O P[®]
 D R O P S C R E E N



Non-tissé composé de cellulose, polyester et fibre de verre.
 Aspect fibreux.

*Non-woven made of cellulosis, polyester and fiber glass.
 Fibrous aspect.*



Classé non feu M1, B1, Class 1, NFPA 701.

Fire resistant M1, B1, Class 1, NFPA 701.



Intérieur.
 Architecture temporaire, kakemono, cloison, bannière, luminaire,
 faux plafond...

*Indoor.
 Temporary architecture, kakemono, partition, banner, lamp shade,
 ceiling...*

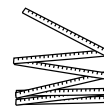

Laize : 2,40 m maximum (et toute autre laize inférieure).
 Rouleaux de 25 ml ou 50 ml et plus
 * Laize : 1,55 m uniquement

*2,40 m wide maximum and any inferior width.
 Rolls of 25 lm or 50 lm and more.
 * 1,55 m only*



Imprimable par sublimation, encres latex.

Printable with dye sublimation, latex inks.



Existe en 15 couleurs.
 Légèreté exceptionnelle (60gr/m²), luminescent et diffuseur de lumière.
 Facile à découper et à confectionner, très stable dimensionnellement,
 conserve la mémoire de plis.

*Available in 15 colours.
 Exceptional lightness (60gr/sqm), good light diffuser
 with luminescent appearance.
 Easy to cut and to transform, good dimensional stability,
 retains memory of folds.*



D R O P P A P E R
D R O P[®]
 D R O P S C R E E N

Toi & Moi McArthurGlen, Athens
 Design : Adrianopoulos + Associates

	100 Blanc <i>100 White</i>
	101 Beige clair <i>101 Light tan</i>
	117 Jaune <i>117 Yellow</i>
	308 Orange <i>308 Orange</i>
	122 Rouge <i>122 Red</i>
	315 Fuchsia <i>315 Fuchsia</i>
	320 Prune <i>320 Plum</i>
	111 Bleu foncé <i>111 Dark blue</i>
	360 Bleu Céladon <i>360 Celadon Blue</i>
	133 Bleu lavande <i>130 Lavender</i>
	304 Vert anis <i>304 Anis green</i>
	C112 Bourgeon * <i>C112 Bud *</i>
	C115 Vert * <i>C115 Green *</i>
	C19 Perroquet * <i>C19 Parrot *</i>
	C85 Menthe * <i>C85 Mint *</i>
	C96 Gazon * <i>C96 Grass *</i>
	C90 Pré * <i>C90 Meadow *</i>
	350 Dune <i>350 Dune</i>
	103 Gris clair <i>103 Light grey</i>
	104 Gris foncé <i>104 Dark grey</i>
	144 Noir <i>144 Black</i>



Le Fluo Drop® est une gamme de Drop Paper® de trois couleurs fluorescentes.

The Fluo Drop® is part of the Drop Paper® collection, available in three fluorescent colours.



Classé non feu M1, B1, Class 1, NFPA 701.

Fire resistant M1, B1, Class 1, NFPA 701.



Intérieur.
Architecture temporaire, kakemono, cloison, bannière, luminaire, faux plafond...

*Indoor.
Temporary architecture, kakemono, partition, banner, lamp shade, ceiling...*

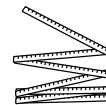

Drop Paper® 60gr/m².
2,40 m de laize.
Rouleaux de 25ml ou 50 ml.

*Drop Paper® 60gr/m².
2.40 m wide.
Rolls of 25 lm or 50 lm.*



Risque d'affaiblissement de la couleur si exposée à la lumière de longues périodes de temps.

Color may fade if exposed too long under light.



Modefabriek, Amsterdam



FLUO
DROP

Magasin Moa, design Jeff van Dyck

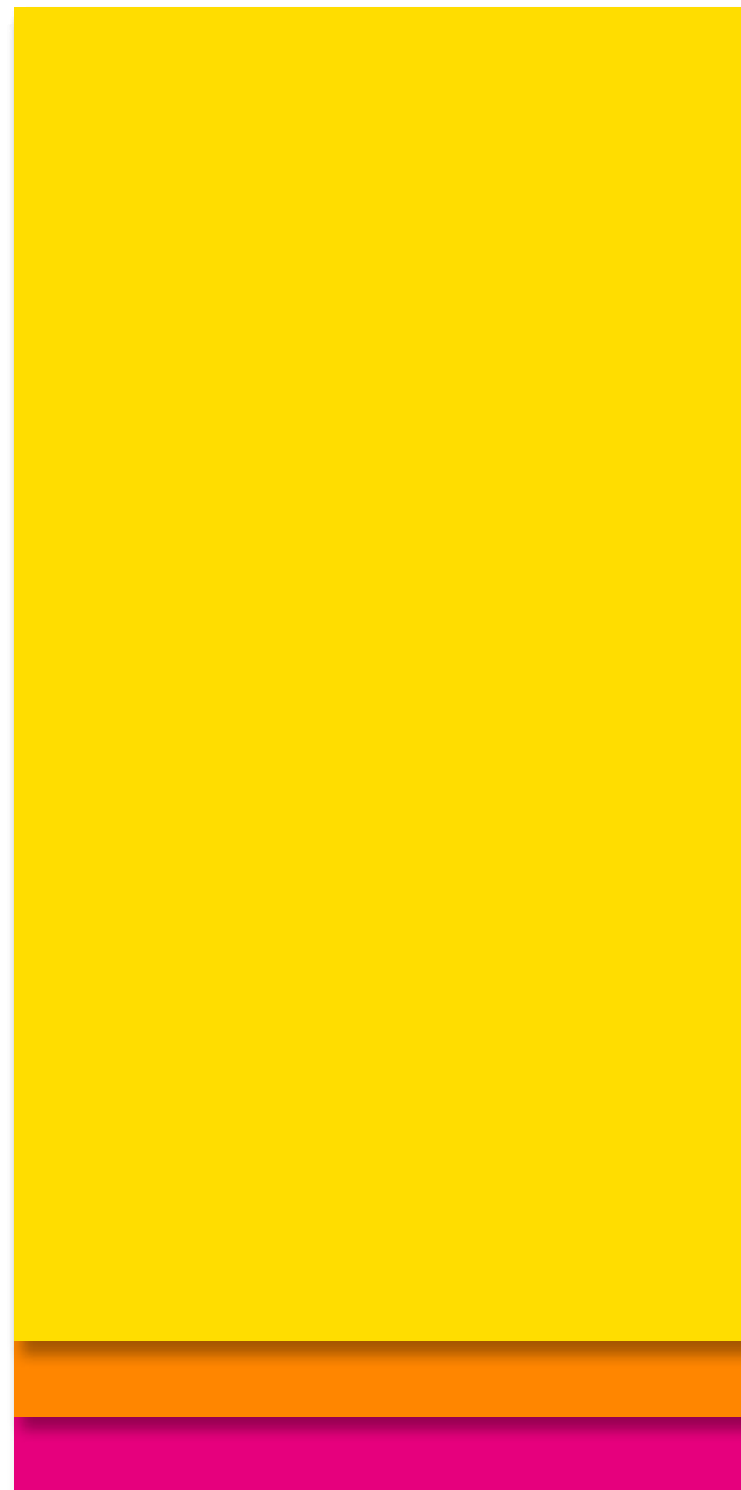

900 Jaune
900 Yellow

901 Orange
901 Orange

902 Magenta
902 Magenta



alacarte

100 colors
Design Emmanuelle Moureaux

alacarte



Non-tissé composé de cellulose, polyester et fibre de verre.
Aspect fibreux.

*Non-woven made of cellulosis, polyester and fiber glass.
Fibrous aspect.*



Classé non feu M1, B1, Class 1, NFPA 701.

Fire resistant M1, B1, Class 1, NFPA 701.



Intérieur.
Architecture temporaire, kakemono, cloison, bannière, luminaire,
faux plafond...

*Indoor.
Temporary architecture, kakemono, partition, banner, lamp shade,
ceiling...*

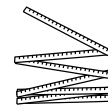

Laize : 1,55 m.

1,55 m wide (61").



Imprimable par sublimation, encres latex.

Printable with dye sublimation, latex inks.



42 couleurs.
Minimum de commande 25 ml.
Délai 10 jours ouvrables

*42 colours.
Minimum order 25 lm.
Delivery time 10 open days.*

	MAGNOLIA
	PÊCHE
	PRUNE
	FIGUE
	ALTHEA
	NOCTURNE
	MÉDITERRANÉE
	PERVENCHE
	LAGON
	MYOSOTIS
	JADE
	MÉLÈZE
	CYPRÈS
	GAZON
	VERT
	PERROQUET
	BOURGEON
	MENTHE
	PRÉ
	LIERRE

	CAFÉ
	TABAC
	SEIGLE
	SABLE
	SERIN
	OR ANCIEN
	ORANGE
	ÉCUREUIL
	SAUMON
	FEU
	ROUGE
	CORAIL
	BORDEAUX
	CHAUDRON
	PASTÈQUE
	MOUSSERON
	AMANDIER
	TENDRESSE
	IRIS
	LILAS



Pulp DROP



Pulp DROP



Un papier 100% cellulose, certifié FSC.

A 100% cellulose paper, FSC certified.



Classé non feu M1, B1, Class 1, NFPA 701.

Fire resistant M1, B1, Class 1, NFPA 701.



Intérieur.
Architecture temporaire, kakemono, cloison, bannière, luminaire,
faux plafond...

*Indoor.
Temporary architecture, kakemono, partition, banner, lamp shade,
ceiling...*

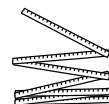

Laize : 1,27 m.
Rouleaux de 60m.
150 gr

*1,27 m wide (50").
60 ml rolls.
150 gr*



Imprimable par sublimation, encres latex.

Printable with dye sublimation, latex inks.



PERFO DROP®



Drop Paper® perforé, blanc ou noir.

White or black perforated Drop Paper®



Classé non feu M1, B1, Class 1, NFPA 701.

Fire resistant M1, B1, Class 1, NFPA 701.



Intérieur. Architecture temporaire, kakemono, cloisons, bannière, luminaire, faux plafond...

Indoor. Temporary architecture, kakemono, partitions, banners, lamp shades, ceilings...

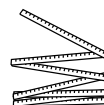

60 gr.

Laize : 1,60 m

60 gr.

Width: 1,60 m

PERFO DROP®

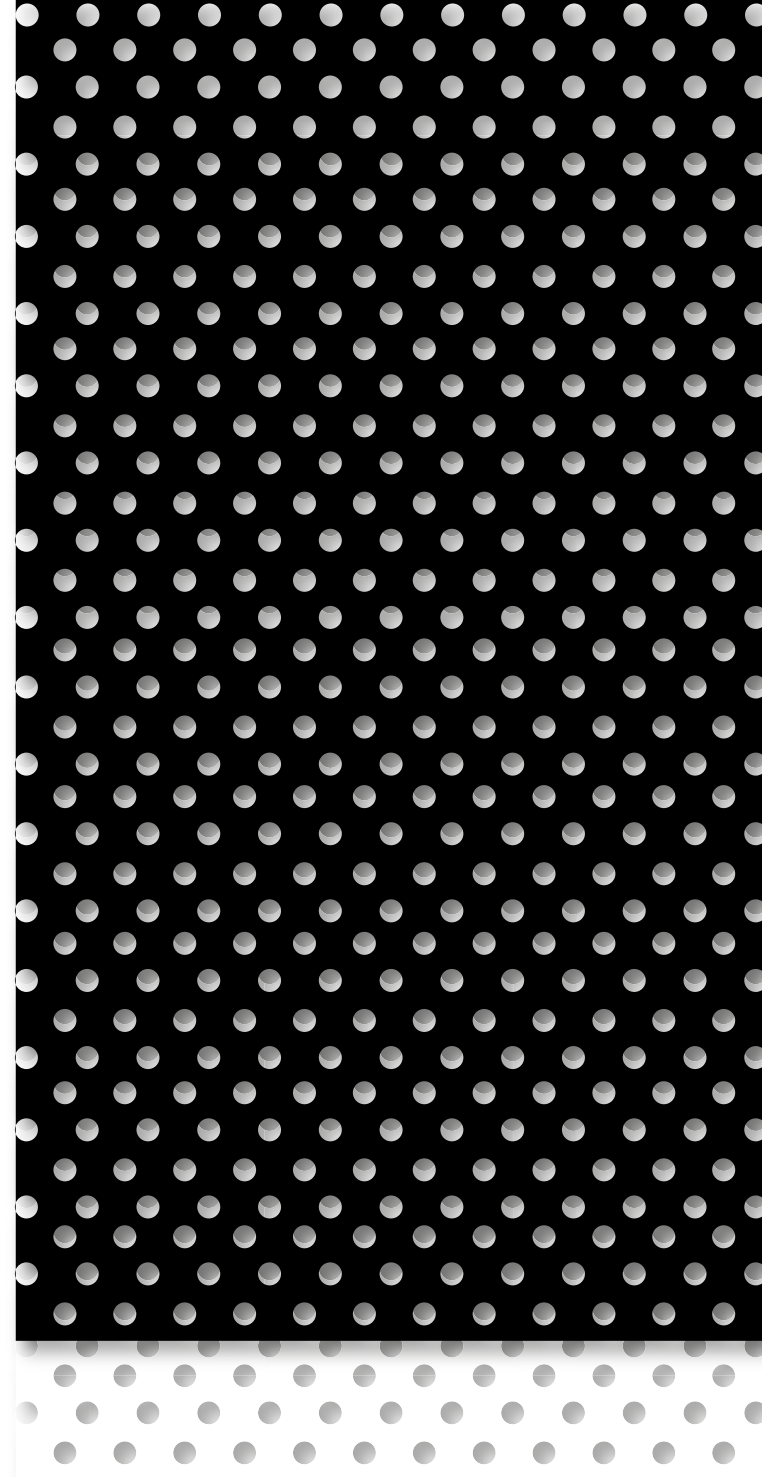



DROPJET®

Printed Drop Paper / Exhibition « Bordeaux Ville de Pierre, un patrimoine à vivre ! »
Maison du Projet des Bassins à Flot

DROPJET®

80/88gr. & 137/138gr.

80/88 gr. Non-tissé composé de cellulose, polyester et fibre de verre.
Aspect fibreux. Spécialement conçu pour l'impression jet d'encre.

*80/88 gr. Non-woven made of cellulosis, polyester and fiber glass.
Fibrous aspect. Especially designed for inkjet printing.*



137/138 gr. Non tissé composé de cellulose et polyester, sans fibre de verre. Aspect lisse. Spécialement conçu pour l'impression jet d'encre.

137/138 gr. Non-woven made of cellulosis and polyester, without fiber glass. Smooth texture. Especially designed for inkjet printing.



Classé non feu M1, B1, Class 1, NFPA 701.

Fire resistant M1, B1, Class 1, NFPA 701.



Intérieur. Architecture temporaire, kakemono, cloisons, bannière, luminaire, faux plafond...

Indoor. Temporary architecture, kakemono, partitions, banners, lamp shades, ceilings...

80gr. / 137 gr. : Épaisseur 0,22 mm. Ø mandrin : 50 mm.
Longueur : 25 ml. Laize : 0,914 m - 1,27 m - 1,372 m - 1,524 m.

*80gr. / 137 gr.: Thickness 0.22 mm. Ø core: 50 mm.
Length: 25 lm. Width: 0,914m / 36" - 1,27m / 50" - 1,372m / 54" - 1,52m / 60"*

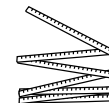

88gr. : Épaisseur 0,22 mm. Ø mandrin : 76 mm.
Longueur : 50ml. Laize : 1,524 m - 2,40 m.

*88gr.: Thickness 0.22 mm. Ø core: 76 mm. Length: 50 lm.
Width: 1,524m / 60" - 2,40m / 94"*

138 gr. : Épaisseur 0,22 mm. Ø mandrin : 76 mm.
Longueur : 50 ml. Laize : 2,40 m.

*138 gr.: Thickness 0.22 mm. Ø core: 76 mm.
Length: 50 lm. Width: 2,40 m / 94"*



80gr. / 137 gr. : DYE, UV.
88gr. / 138 gr. : ECO SOLVANT, SOLVANT, UV, LATEX.

*80gr. / 137 gr.: DYE, UV.
88gr. / 138 gr.: ECO SOLVENT, SOLVENT, UV, LATEX.*



DROPEX[®]

Plusieurs possibilités de fixations *
 Adhésif double face 3M 950 (ourlets).
 Velcro (Lighted Drop®).
 Adhésif repositionnable (Luminares).
 * Voir fiche d'instructions montage.



Many fixing methods *
 Double sided adhesive tape 3M 950 (hem pockets).
 Velcro (Lighted Drop®).
 Removable adhesive tape (Lightings).
 * See instructions datasheet.

Après utilisation, doit être rangé soigneusement dans son emballage d'origine à l'abri de l'humidité et verticalement pour une conservation optimale.

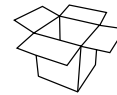

After usage, carefully place the roll vertically in the original packaging without humidity for the best conservation.

Très bonne stabilité dimensionnelle.
 137/138 gr. : stabilité dimensionnelle inférieure au 80 gr et 88 gr.
 137/138 gr. : diffusion de la lumière inférieure au 80 gr et 88 gr.
 Impression recto seul.
 Produit léger.
 Bonne diffusion de la lumière.
 Réutilisation difficile.
 Ne résiste pas à l'eau.
 Faible résistance mécanique.



No curving effect.
 137/138 gr.: dimensional stability inferior to 80 gr and 88 gr.
 137/138 gr.: light diffusion inferior to 80 gr and 88 gr.
 One side printing only.
 Lightweight product.
 Good light diffusion.
 Difficult to re-use.
 Not water resistant.
 Delicate material.

Dépend de l'application : un luminaire suspendu ou un plafond installés dans un lieu propre et sec peuvent durer plus de 5 ans..



Depending on the application: a hung lighting element or a ceiling installed in a dry and clean place can last more than 5 years.

Note : Ces informations correspondent à nos connaissances actuelles et sont destinées à vous informer, sans obligation, sur nos produits et leurs usages.

Nota: This information corresponds to our present state of knowledge and is meant to inform you without obligation about our products and their use.



easy DROP®



Papier peint pré-encollé

Pre-coated with adhesif wallpaper



Classé non feu M1.

Fire resistant M1.



Intérieur.
Décoration murale

*Indoor.
Décoration murale*

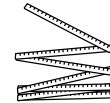

167gr
1m20 laize

167gr
1m20/47" wide



Imprimable par sublimation, encres latex.

Printable with dye sublimation, latex inks.



Rouleaux de 25 ml
Peut être découpé sur mesure
Ne nécessite qu'un spray d'eau pour être installé sur un mur

*25 ml rolls
Can be cut upon order
Only needs water sprayed to stick on a wall*

easy DROP®



SparkleDROP®

SparkleDROP®

Non classé au feu
Not fire-resistant



Le Sparkle Drop® est une technique permettant la métallisation sur Drop Paper et Drop Jet.

Cette option apporte au Drop un aspect scintillant par transfert de feuilles argentées ou dorées selon un motif défini.

Sparkle Drop is a technique where a metal finish is applied onto Drop Paper and Drop Jet.

Sparkle Drop offers a shiny golden or silver effect to the Drop, thanks to the transfer of gold or silver sheets with a defined pattern.

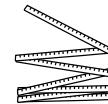

Laize : 1,50 m.

width: 1,50 m.



Support haut de gamme, le Sparkle Drop® donne un aspect brillant aux applications qui en sont faites. Il répond plus particulièrement aux utilisations du secteur du luxe pour une signalétique ou un décor des plus étincelants.

Sparkle Drop® is a «top of the range» material that has a shiny touch to the surface. Especially manufactured for the luxury sector and used for signage or interior displays requiring flashy and classy renderings.



Existe en or ou argent, autres couleurs sur demande.
Imprimable si la métallisation s'applique sur Drop Jet.

*Available in gold and silver, other colors on demand.
Printable if metal finish is applied onto Drop Jet.*

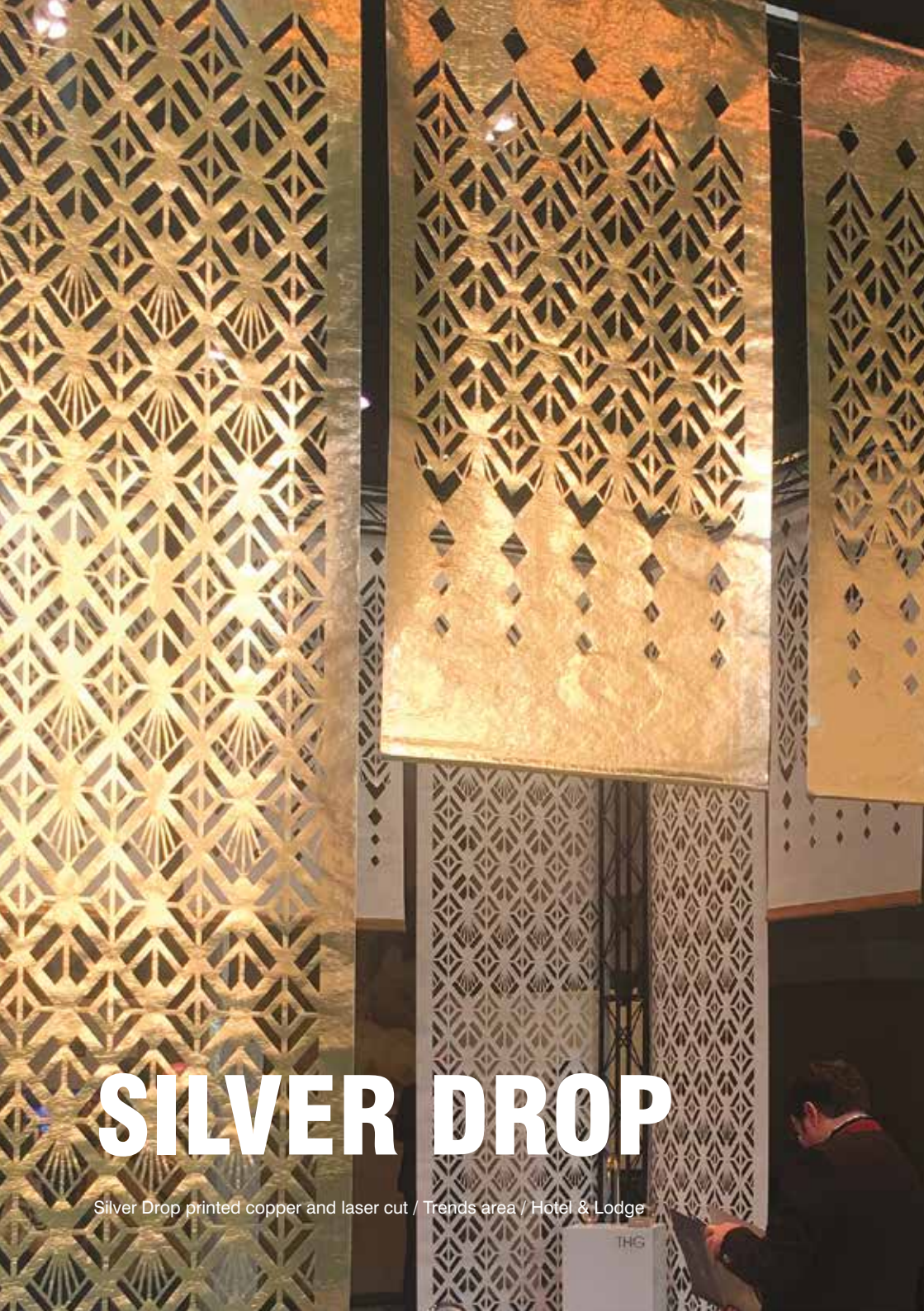

SILVER DROP

Silver Drop printed copper and laser cut / Trends area / Hotel & Lodge

SILVER DROP

Le Silver Drop® est une technique permettant l'ajout d'une fine couche d'aluminium sur Drop Paper® blanc 60 gr. Cette option apporte au Drop Paper® un aspect miroir argenté, qui peut ensuite être imprimé d'une autre couleur pour obtenir un cuivré ou un doré.



Sparkle Drop is a technique that adds a thin layer of aluminium onto a 60gr white Drop Paper®. Sparkle Drop creates a shiny mirror effect on Drop Paper®, which can in turn be printed with a color to get a gold or copper effect for instance.



Classé non feu M1.

Fire resistant M1.

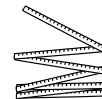

130 gr/m².
Laize : 0,90 m.

*130 gr/m².
width: 0,90m / 35".*



Faux plafond, luminaire, bannière et displays etc...

Ceilings, lightings, banners and displays...



Impression numérique à base acqueuse, encres latex et UV.

Digital printing : dye, latex and UV inks.



Résistance mécanique.

Opacité 90 %.

100 % recyclable.

Pâte naturelle issue de la gestion durable des forêts.

Mechanical strength.

90% opaque.

100% recyclable.

Natural paste from sustainable forest management.



CRISTAL
DROP®



Papier calque translucide en cellulose, classé non feu et imprimable, pour la réalisation de luminaires, bannières, displays etc...

Tracing paper, translucent and made of cellulose, fire resistant and printable to create lightings, banners, displays etc...



Classé non feu M1.

Fire resistant M1.

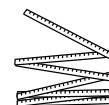

125 gr/m².
Laize : 1,27 m.

*125 gr/m².
width: 1,27 m / 50".*



Impression numérique à base aqueuse, encres latex.

Digital printing dye, latex inks.



Opacité 20 %.
100 % végétal.
100 % recyclable.
Pâte naturelle issue de la gestion durable des forêts.

*Opacity: 20 %.
100 % vegetal.
100 % recyclable.
Natural paste from sustainable forest management.*

CRISTAL
DROP®

Première Vision, Design by Vachon

SILK DROP®



Papier de soie, 100 % cellulose, 25 gr/m²

Silk paper 100 % cellulosis, 25 gr/m²



Classé non feu M1.

Fire resistant M1.



Intérieur, décors par pliage et froissage, origami.

Indoor, displays by folding or creasing smoothly, origami.

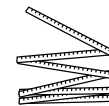

Laize : 2 m

Rouleaux de 250 ml

Width : 2 m

Rolls of 250 ml



Existe en blanc.

Luminescent et diffuseur de lumière.

légèreté exceptionnelle (25 gr/m²).

Sensible aux variations thermiques et hygrométriques.

Available in white.

Good light diffuser with luminescent appearance.

Exceptional lightness (25gr/m²).

Sensitive to thermal and moisture.

SILK DROP®

Défilé STONE ISLAND 30
Design MATTIA DORICI & LUCA BERTOZZI



KRAFT DROP®



Papier kraft pure cellulose.

Pure cellulose kraft paper.



Classé non feu M1.

Fire resistant M1.



130 gr/m².
Laize : 1,27 m.

*130 gr/m².
width: 1,27 m / 50".*



Faux plafond, luminaire, bannière et displays etc...

Ceilings, lightings, banners and displays...



Impression numérique à base acqueuse, encres latex.

Digital printing : dye, latex inks.



Résistance mécanique.

Opacité 90 %.

100 % recyclable.

Pâte naturelle issue de la gestion durable des forêts.

Mechanical strength.

90% opaque.

100% recyclable.

Natural paste from sustainable forest management.

KRAFT DROP®



Lejaby



DROPnet®

Manor, Design Saguez & Partner

DROPnet®



Le Drop Net® est un textile semi transparent léger, composé à 100 % de polyester. Ce support est imprimable et permet une lisibilité de l'impression recto verso. La légèreté de la matière apporte un côté subtil et esthétique à son utilisation.

Drop Net® is a 100% polyester semi-transparent knitted mesh textile, to achieve light and subtle interior screens. This printable solution is visible on both sides.



Classé non feu M1.

Fire retardant M1.

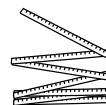

180 gr/m².
Laize : 1,80 m.

*180 gr/m².
width: 1,80 m.*



Idéal pour des écrans imprimés suspendus ou marouflés sur cadre. Il est très apprécié pour mettre en valeur la signalétique ou pour jouer avec les séparations d'espaces dans les salons, expositions.

Ideal for printed screens, suspended or framed. Signage, partition walls within trade fairs and exhibitions...



Compatible avec tout type d'imprimante, encres latex.

Compatible with any digital printers, latex inks.

PROCÉDÉS CHÉNEL®
INTERNATIONAL
Matériaux et Techniques spécialisées pour l'Exposition, la Décoration et la Muséographie.

STRONG
DROP®

Paper Night 2010, Procédés Chénel

STRONG DROP®



Non tissé blanc très résistant, 70% polyester et 30% polyamide.

Very resistant white non woven, 70% polyester and 30% polyamide.



Classé non feu M1.

Fire resistant M1.

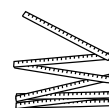

118 gr/m².
Laize : 2,15 m.

*118 gr/m².
width: 2,15 m.*



Réalisation de volume lumineux, guirlandes, bannières, etc.

For lightings, garlands, banners, etc.



Imprimable dye et solvant, encres latex.

Printed with dye or solvent, latex inks.



Forte résistance mécanique.
Fabrication propre.
Sans PVC.
Composants inoffensifs.
Déchets sans risques.
Labélisé Oeko-Tex 100 classe 1.

*High mechanical resistance.
Clean production.
PVC free.
Innocuous substances.
Safe wastages.
Labelised Oeko-Tex 100 class 1.*



HARD
DROP®

HARD DROP®



Carton double cannelure blanc

Double corrugated cardboard, white



Classé non feu M1, B1.

Fire resistant M1, B1.



Intérieur. Architecture temporaire, cloisons...

Indoor. Temporary architecture, partitions...

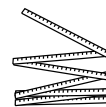

Plaque 1,20 x 2 m

1,20 x 2 m panels



Imprimable à plat

Flatbed printer



Peut se découper

Can be cut



DECOLIT® PEARLY 251

FERRARI
architecture



Tissu polyester haute tenacité enduit, toile pleine.

High resistance polyester coated textile.



Classé non feu M1, B1.

Fire resistant M1, B1.

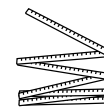

325 gr/m².
Laize : 1,60 m.

325 gr/m².
Width: 1,60 m / 63".



Banderoles, displays, kakémonos de grandes surfaces, événementiel, stands, vitrines...

Banners, displays, large surfaces, events, stands, shop windows...



Impression numérique solvant et éco-solvant, encres latex.

Digital printing solvent and eco-solvent, latex inks.



100 % recyclable.

Euroclasse Bs1d0 selon la norme EN 13501-1.

Toile très fine et très légère : grande souplesse.

Aspect mat : très faible réflexion lumineuse.

Très bonne stabilité dimensionnelle dans le temps.

Absence de «curving» après impression.

Aspect nacré.

100% recyclable

Euroclasse Bs1d0 / EN 13501-1 standard.

Very thin and light, very flexible.

Matt finish, very low light reflection.

High dimensional stability through time.

No «curving» after printing.

Pearly finish.

FERRARI
architecture



TEXTILES ENDUITS
COATED TEXTILES



Tissu polyester haute tenacité enduit, toile pleine.

High resistance polyester coated textile.



Classé non feu M1, B1.

Fire resistant M1, B1.

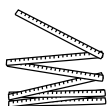

325 gr/m².
Laize : 2,50 m.

325 gr/m².
Width: 2,50 m / 98,4".



Banderoles, displays, kakémonos de grandes surfaces, événementiel, stands, vitrines...

Banners, displays, large surfaces, events, stands, shop windows...



Impression numérique solvant et éco-solvant, encres latex.

Digital printing solvent and eco-solvent, latex inks.



100 % recyclable.
Euroclasse Bs1d0 selon la norme EN 13501-1.
Toile très fine et très légère : grande souplesse.
Aspect mat : très faible réflexion lumineuse.
Très bonne stabilité dimensionnelle dans le temps.
Absence de «curving» après impression.

*100% recyclable
Euroclasse Bs1d0 / EN 13501-1 standard.
Very thin and light, very flexible.
Matt finish, very low light reflection.
High dimensional stability through time.
No «curving» after printing.*



Grille textile polyester enduite, haute ténacité .

Polyester coated textile mesh with high resistance.



Classé non feu M1, B1.

Fire resistant M1, B1.

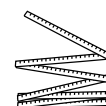

DECOMESH 221
250 gr/m².
Laize : 2,50 m.

250 gr/m².
Width: 2,50 m / 98,4".

DECOMESH 331
340 gr/m².
Laize : 2,50 m.

250 gr/m².
Width: 2,50 m / 98,4".



DECOMESH 221
Intérieur.
Banderoles, displays, stands, stores, vitrines...

*Interior
Banners, displays stands, sun screens, shop windows...*

DECOMESH 331
Intérieur et extérieur.
Aménagement d'espace, banderoles, displays, stands, façades, stores...

*Indoor and outdoor.
Interior architecture, banners, displays, stands, façades, sun screens...*



Impression numérique solvant et éco-solvant, encres latex.

Digital printing solvent and eco-solvent, latex inks.

Impression numérique solvant et éco-solvant, encres latex.

Digital printing solvent and eco-solvent, latex inks.



DECOMESH 221
100% recyclable.
Textile micro perforé.
Coefficient d'ouverture 3%.
Semi-mat.
Stabilité dimensionnelle exceptionnelle.
Légereté et souplesse.

*100% recyclable.
Micro-perforated textile.
Opening rate 3%.
Semi-matt.
High dimensional stability.
Light and flexible.*

DECOMESH 331
100% recyclable.
Effet occultant sur la face non éclairée.
Aspect très régulier : rendu très net des visuels.
Très faible prise au vent.
Coefficient d'ouverture 14%.

*100% recyclable.
Darkening effect on the non lighted side.
Very regular, images are very sharp.
Low wind sensitivity.
Opening rate 14%.*

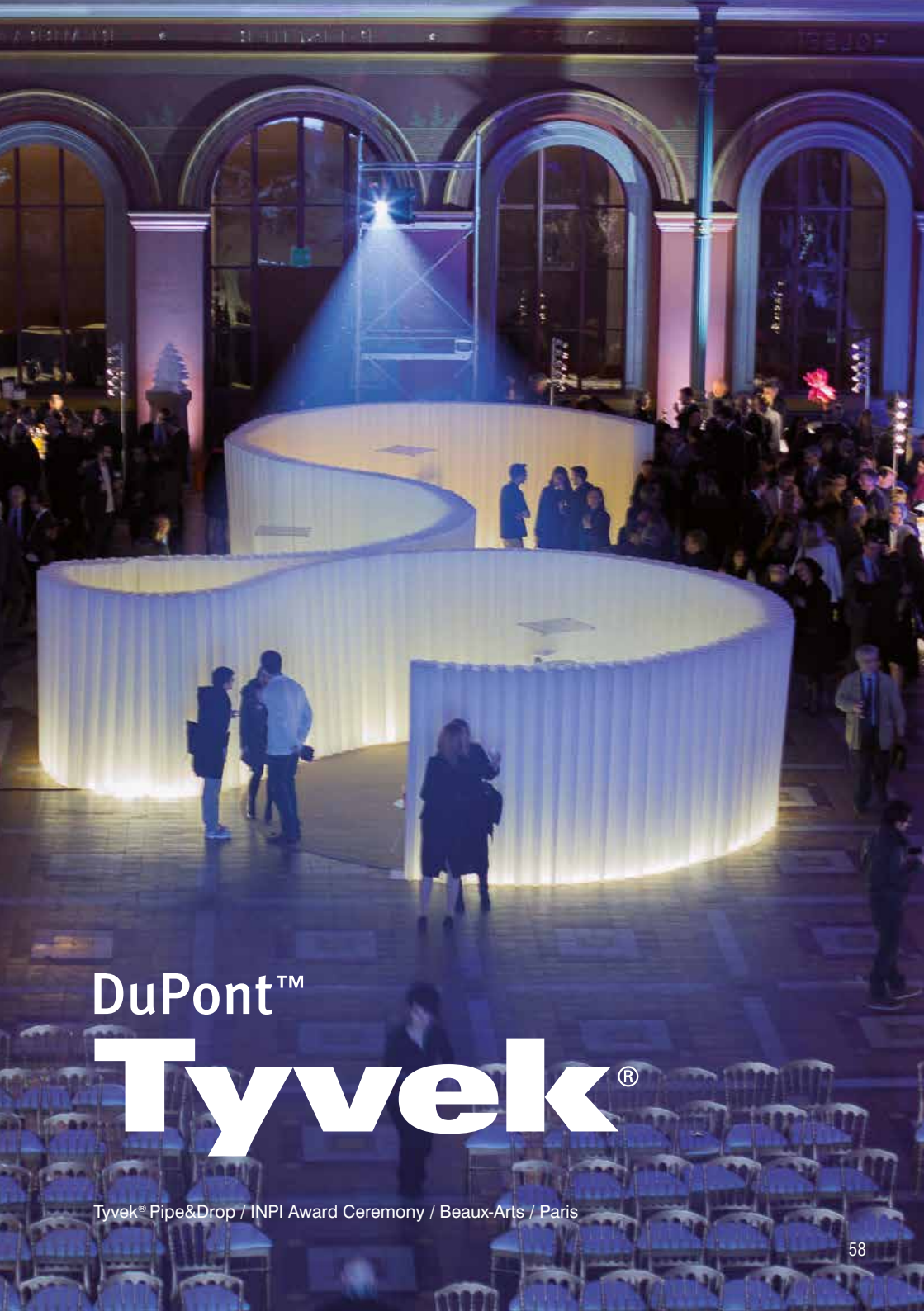

DuPont™ Tyvek®

Tyvek® Pipe&Drop / INPI Award Ceremony / Beaux-Arts / Paris

DuPont™ Tyvek®



DuPont™ Tyvek® est un non-tissé extrêmement résistant, fabriqué en fibres de polyéthylène haute densité. Tyvek® est léger, lisse et indéchirable.

DuPont™ Tyvek® is made of pure high density polyethylene fibers. Tyvek® is extremely resistant, light, smooth and tear-resistant.



Classé non feu M1, B1, Euro Class : B S1 D0.

Fire resistant M1, B1, Euro Class : B S1 D0.

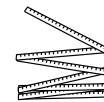

140 gr/m².
Laize 1m.

*140 gr/m².
Width 1m / 39.3"*



Réalisation de murs Pipe&Drop. Tyvek® ajoute résistance et longévité au produit.

Pipe&Drop walls. Tyvek® brings resistance and longevity to this product.



Encre UV ou latex.

UV ink and latex.



Grande résistance mécanique.
Opacité 97 %.
Garantie sans antimoine et produits halogénés.

*High mechanical strength.
97% opaque.
Without antimony or halogenated products.*

DuPont™ et Tyvek® sont des marques ou marques déposées de E.I. du Pont de Nemours ou de ses sociétés affiliées.



HONEYCOMB

Exposition *Architectures de papier*
Cité de l'Architecture

HONEYCOMB



Nid d'abeille en Drop Paper®.
Honeycomb made out of Drop Paper®.



Classé non feu M1.
Fire resistant M1.

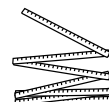

Drop Paper® 60 gr/m². Bandes de 1,395 à plat et 1,00 m déplié.

Drop Paper® 60 gr/m². Stripe flat : 1,395 m / 55" - stretched stripe: 1 m /



Faux plafond, cloisons, mobilier...
Ceilings, lightings, banners and displays, furniture...



15 couleurs standards.
15 standard colours.

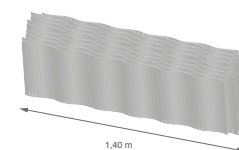

=

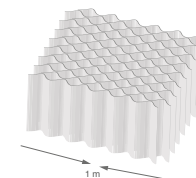

La largeur est réduite quand les alvéoles sont étirées / Width is reduced when the cells are stretched

12, 6 ou 3 alvéoles par mètre
12, 6 or 3 cells per meter

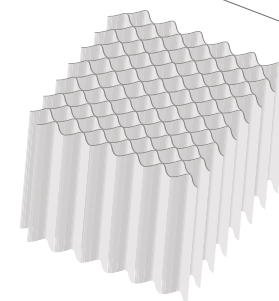

épaisseur personnalisée = jusqu'à 80 cm
custom height up to 80 cm



SMOKE OUT®

Le Smoke Out est un tricot à mailles bloquées extensible en Trévira CS, classé non feu M1 et destiné à la réalisation de plafonds masquants temporaires de sécurité. Ses lignes fusibles tous les 33 cm permettent en cas d'incendie l'évacuation des fumées par l'ouverture automatique du textile et le déclenchement des sprinklers.



Smoke Out is a stretch knitted fabric made of Trevira CS for temporary masking and security ceilings. The melting lines every 33 cm (12") provide, in case of fire, automatic opening to enable smoke to escape and sprinkler to shower the fire.



Classé non feu M1, B1, NFPA701.

Fire resistant M1, B1, NFPA701.

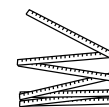

Existe en rouleaux de 50 ml.
2,80 m de largeur extensible à 3 m.

*Rolls of 50 lm.
2,80 m (110') wide, stretchable to 3 m (118").*



Existe en blanc et noir.
Le textile doit être tendu avec attention pour être efficace.
Il peut être fixé sur cadre aluminium avec du velcro
ou agrafé sur châssis bois.

*Available in white and black.
The textile shall be very well stretched in order to be efficient.
We can set up Smoke Out onto aluminium frame with velcro tape or staple it on a wooden frame.*



Assemblage par coutures zig zag. S'installe agrafé sur châssis
ou fixé sur bande velcro.

*Overlap the stretchable fabric and sew with zigzag stitches
to assembly Smoke Out.*

SMOKE OUT®

Musée du Quai Branly
Design Jean Nouvel

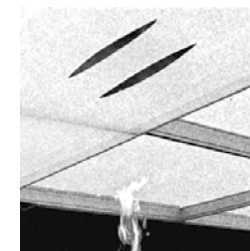



HARU

stuck-on
design;

Rubans adhésifs fabriqués par HARU, distribués en exclusivité en France par Procédés Chénel. Une solution facile et inventive pour personnaliser tous vos espaces !



*Exclusively distributed in France by Procédés Chénel.
An easy and inventive solution to custom all spaces!*

Ces rubans adhésifs sont disponibles en 8 familles de couleur unies différentes, en 2 familles de motifs différents, en 3 matériaux différents (Washi Tape, PET Tape, OPP Tape transparent) et 4 largeurs (50mm, 150mm, 300mm or 600mm)

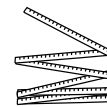

These tapes are available in 8 different families of solid colors, 2 families of patterns, 3 different materials (Washi Tape, PET Tape, OPP Tape transparent) and 4 width (50mm, 150mm, 300mm or 600mm).

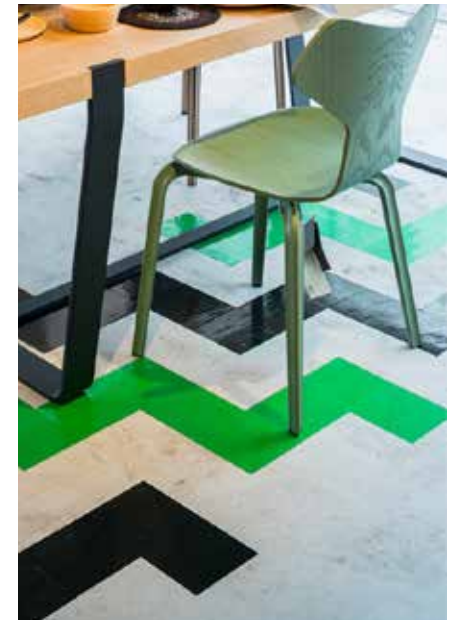

DROP® CAKE

turning paper waste into recycled boards

Non classé au feu
Not fire-resistant



Panneaux rigides fabriqués à partir de chutes de production de Drop® Paper. Composé de 60 % de déchets de Drop® Paper et 40 % de déchets de polyéthylène. Chaque plaque permet de recycler environ 270 m² de Drop® Paper.

Rigid panels made out of Drop® Paper production waste. Composed of 60% Drop® Paper waste and 40% polyethylene waste. Each board corres-

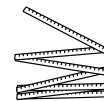

Plaque de 1,20 x 2 m et 1 x 2,50 m
Épaisseur 8-9 mm

*1.20 x 2 m / 47.24" x 78.74" and 1 x 2,50 m / 39.37" x 98.42" boards
Thickness 8-9 mm*



- Flocons de papier pressés à chaud, aucun ajout de produit chimique
- Recyclable à l'infini
- Idéal pour mobilier, luminaire, PLV, cabanes...

- *Hot pressed paper flakes, no chemical addition.*
- *Ininitely recyclable*
- *Ideal for furniture, lighting, POS, cabins...*

DROP® CAKE
turning paper waste into recycled boards

Crispy DROP®



Composé de feuilles de cellulose plissées et collées transversalement.

Composed of cellulose sheets pleated and assembled transversely.



Classement au feu : M1
Classement fumée et toxicité : F1

Reaction to fire M1
Smoke and toxicity F1



Usage : intérieur, pour du cloisonnement.

Use : indoor, for partition walls.

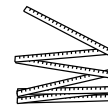

Dimensions : Plaques de 3 x 0,90 m. Epaisseur 4 cm.
Poids : 13 kg /m3 - 520 gr /m2

Dimensions : Panels of 3 x 0,90 m. Thickness 4 cm.
Weight : 13 kg /m3 - 520 gr /m2



- Produit 'naturel' (cellulose pure)
- Recyclable
- Inoffensif
- Sans fibres
- Léger
- Rigide
- Biodégradable
- Facile à découper et à mettre en oeuvre

- 'Natural' product (pure cellulose)
- Recyclable
- Non toxic
- Without fibres
- Lightweight
- Rigid
- Biodegradable
- Easy to cut and work with

Crispy DROP®



LES APPLICATIONS

THE APPLICATIONS



PLAFONDS

CEILINGS



PLAFONDS
HONEYCOMB
 CEILINGS

Le plafond en papier Honeycomb est une nappe d'alvéoles en nid d'abeille pour masquer efficacement toutes les vues supérieures des halls.



Honeycomb paper ceiling® is a succession of honeycomb paper cells to mask any upper views of the exhibition halls.



Classé non feu M1.

Fire resistant M1.

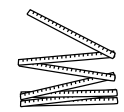

3 formats standards :
 H 4 cm / 12 alvéoles et H 8 cm / 6 alvéoles et H 16 cm / 3 alvéoles

*3 standard sizes :
 H 4 cm / 12 cells and H 8 cm / 6 cells and H 16 cm / 3 cells*

Plafonds de sécurité
 Encore plus masquant
 Léger et élégant. Diffusion des flux lumineux
 Isolant acoustique. Très faible volume
 Pose facile
 3 types de nappes disponibles
 Un large choix de couleurs
 Brevet international



*Security paper ceiling
 Ceiling so masking
 Light and Elegant. Diffusion of light
 Sound absorption, Low volume
 Easy setup
 3 different dimensions, A large range of colours
 International patents*

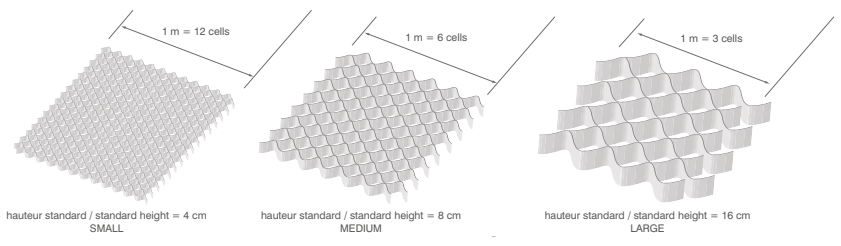

PLAFONDS
HONEYCOMB
 CEILINGS

Stand Pink Lady
 Design Sted Bis - Laurent Boaretto



Citibank Singapur, design by : Hoa Huang/Nigel Liao, Geyer Environments Pte Ltd



PLAFONDS[®]
HONEYCOMB
CEILING S

Krekenavos Park exhibition,
design : Skirmante Vaitkeviciute



DROP® STRIP E

Equip'hotel, design Elisabeth Leriche

DROP® STRIP E

Système de faux-plafond en bandes de Drop Paper® parallèles tendues dans un plan vertical. Ces bandes décoratives, compatibles avec tous les systèmes de sécurité, peuvent également devenir supports de signalétique.



Ceiling system made of parallel strips of Drop Paper® stretched in a vertical plane. Compatible with any security systems, these strips can also be used as graphic support.



Classé non feu M1, B1.

Fire resistant M1, B1.

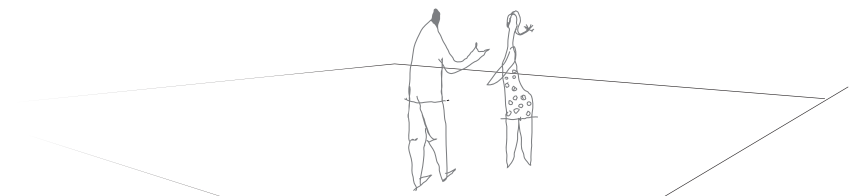
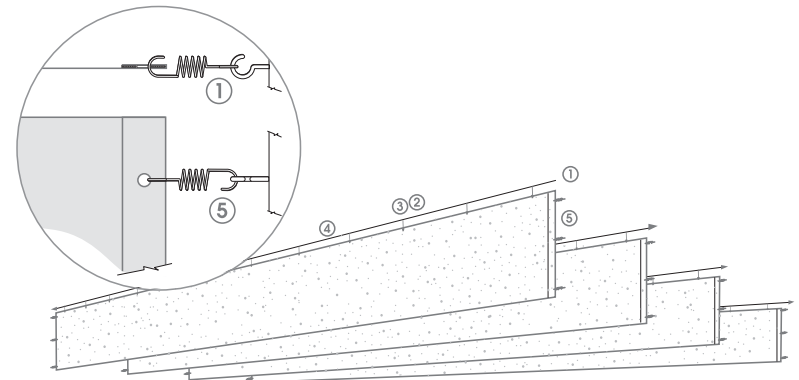



DROP[®] STRIPE

Drop Stripe, Carrefour Nice, design: Generous Branding



DROP[®] STRIPE

Carrefour Sartrouville, Design : Marc Sitbon



LASER DROP®

LASER DROP®



Découpe sur Drop Paper® blanc ou couleur de tous motifs vectorisés, standards ou sur mesure.

Cut on white or coloured Drop Paper® of any vectorised, standard or custom design.



Classé non feu M1, B1.

Fire resistant M1, B1.



LASER DROP®

Stand Land Rover



DROP® GONDOLA

Stand de la ville de Turin
Design by Carlo Viano

DROP® GONDOLA largeur

Les bandes de Drop Paper® sont simplement suspendues par leurs extrémités à des points d'accrochage supérieurs, à l'aide de tubes aluminium passés dans des ourlets simples.

Le galbe se fait naturellement en fonction des points d'accroche et de la longueur des bandes.



Drop Paper® strips are simply hung to upper frame or structure by means of aluminium tube in a simple hem. The vault will be custom made depending on the width of the upper structure and the length of stripe.



Classé non feu M1, B1.

Fire resistant M1, B1.

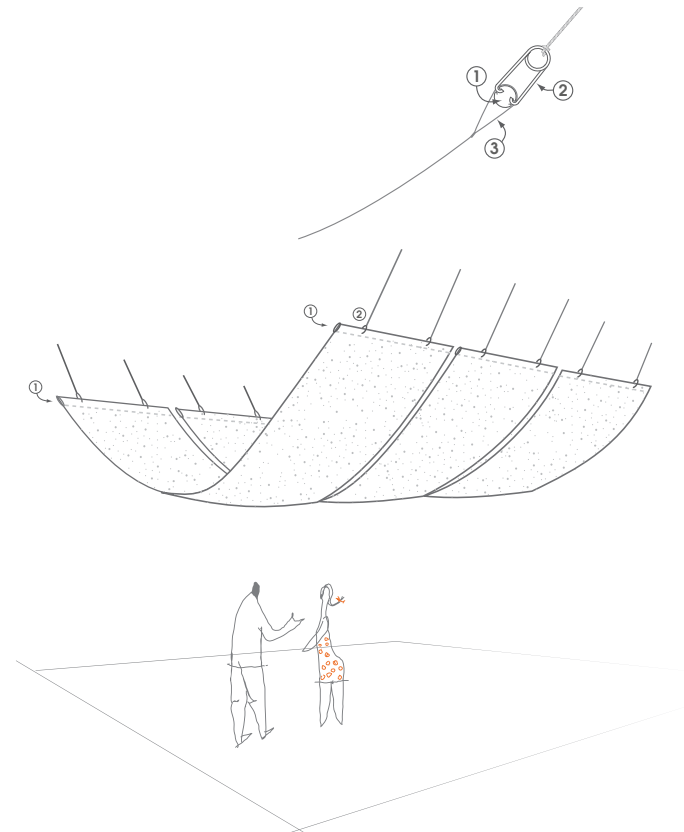

GRANDFORM

SEA

SEA

Sardane

Pasodoble

DROP[®]
GONDOLA



DROP® GONDOLA

Exposition Man Ray

DROP® GONDOLA longueur

Bandes de Drop Paper® cintrées en demi cercle dont les deux extrémités sont collées sur une plaque aluminium cintrée et percée. Comme pour le Drop Stripe®, de petites agrafes suspendent les gondolas tous les 60 cm à un câble d'acier tendu au-dessus.



Ceiling system made of Drop Paper® strips vaulted in half circle. Ends are stricked on a pre-vaulted aluminium stripe with holes. As for Drop Stripe®, small dips hang the paper on a stretched upper steel cable every 60 cm(23').



Classé non feu M1, B1.

Fire resistant M1, B1.

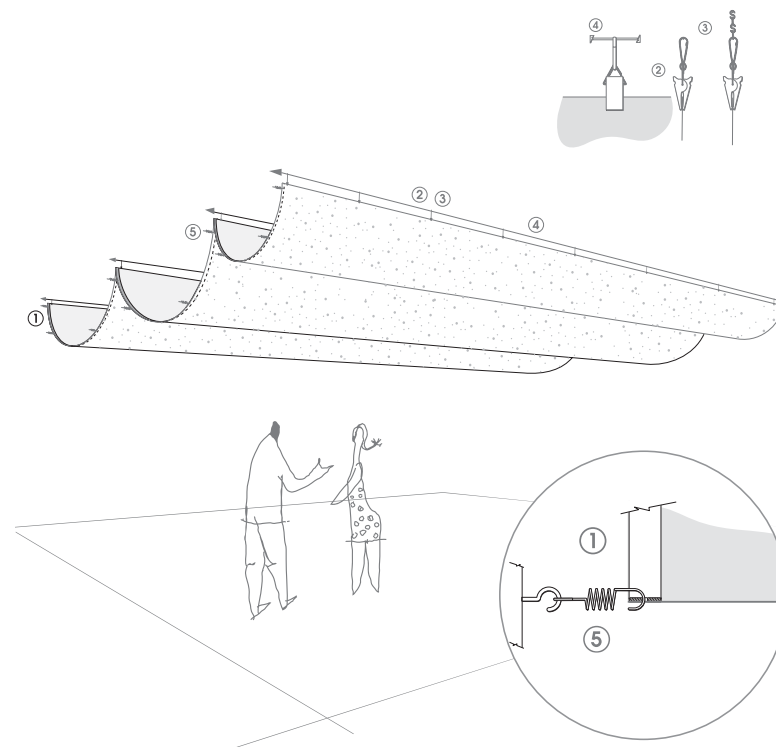



CRISTINA

DROP[®]
GONDOLA

Stand Cristina, Design Makio Hasuike & Co



PLAFONDS
**PARA
LUME**[®]
CEILINGS



Les plafonds Paralume utilisent les qualités du Drop Paper[®] en réalisant des réseaux d'alvéoles juxtaposées ouvertes dans le sens vertical.

The Paralume ceilings benefit from the Drop Paper[®] qualities making a network of large vertical open cells.



Classé non feu M1, B1.

Fire resistant M1, B1.



- Vision masquée quelque soit l'angle
- Respect des règles de sécurité
- Facilité d'installation sur pont lumière
- Variation de translucidité
- Luminescence variable
- Possibilité de relief 3D
- Possibilité d'intégrer les perforations du Laser Drop[®].

- *Obscured sightlines regardless of viewing angle*
- *Respect of the security regulations*
- *Easy set up on upper structure*
- *Variation of translucency*
- *Graduation of lighting*
- *Three-dimensional option*
- *Laser Drop[®] option*



PLAFONDS
**PARA
LUME**[®]
CEILINGS



PLAFONDS
**PARA
LUME**[®]
CEILINGS



Citibank Singapour, design by : Hoa Huang/Nigel Liao
Geyer Environments Pte Ltd



SMOKE OUT®

COMMANDE DE SMOKE OUT® / ORDERING SMOKE OUT®

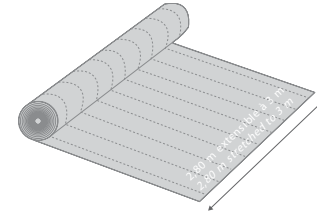

Le Smoke Out® se présente en laize de 2,80 m extensible à 3 m. Important : le Smoke Out® est livré en rouleaux sous tension. Le ruban en papier décimétrique indique la longueur de Smoke Out® nécessaire pour réaliser un lè de plafond tendu. En revanche, le Smoke Out® n'est pas tendu en largeur de laize sur le rouleau. Les 2,80 m environ apparents, doivent être complétés pour couvrir 3 m de large.

Exemple : pour réaliser un plafond de 50 m x 15 m, compter 5 rouleaux de 50 m de long (15 : 3 = 5) et réaliser 4 coutures en zig zag.

Smoke Out® is sold in widths of (94 inches) and can stretch to 3 inches).

Important : Smoke Out® is delivered rolls that are under tension in the A measuring tape is rolled with it duct to show the tensioned length roll. The width of the fabric is not tension and can be stretched up when installed.

Example : to achieve a ceiling of 15 m wide you need 5 rolls of 50 (3 = 5), and 4 zig zag sewings.

POSE DU SMOKE OUT® / HANGING SMOKE OUT®

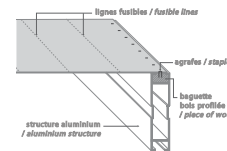

Le Smoke Out® est facile à poser. Il peut être agrafé en périphérie sur des lisses de bois et fixé sur ou sous des structures aluminium classiques après avoir placé dans les gorges de celles-ci des baguettes profilées en bois.

Smoke Out® is easy to work with. It can be stapled to wood frames or aluminium structures once wood are placed in the grooves.

FIXATION DU VÉLUM SMOKE OUT® / SMOKE OUT® SETTING UP

Sur un cadre aluminium avec une bande velcro (côté mâle) adhésivé sur un cadre aluminium
Smoke Out stretched on a velcro tape adhesived on an aluminium frame.

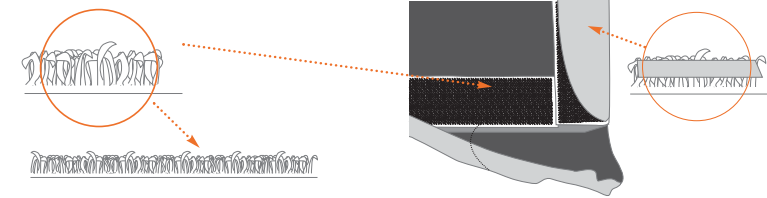

GRAND VELUM / LARGE HUNG CEILINGS

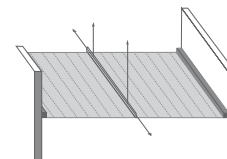

Comme le vélum classique, le Smoke Out® peut être cousu bord à bord par des coutures en zig zag de préférence et soutenu par un fil de fer passant dans des coulisses. À leur tour, ces fils sont soulagés par des suspentes dans le cas de grands véllums. Il n'est pas nécessaire d'établir des réseaux de fils sous le Smoke Out®.

As with classic hung ceilings, Smoke Out® can be sewn selvage to selvage with zig zag sewing, and held will slipped into the hems. In the case of large hung ceilings, the hem wire held to the building structure by wires. It is not necessary to set up network under Smoke Out®.

SMOKE OUT®



SMOKE OUT



SMOKE OUT





CLOISONS

PARTITIONS



**Paper
Box®**
by PROCÉDÉS CHÉNEL^{INTL.}
Architectures de papiers



GERMAN
DESIGN
AWARD
GOLD
2016



Focus Open 2015
Gold
International Design Award
Baden-Württemberg



Green
Product Award
Winner 2015

[Paper Box]



Un système d'exposition carton.

A cardboard exhibition and display system.



Classé non feu M1, B1.

Fire resistant M1, B1.

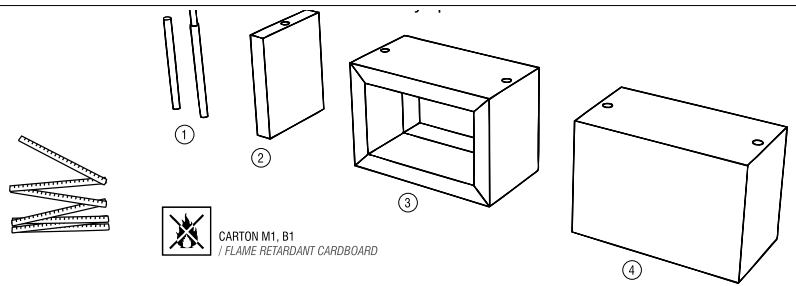

①

CONNECTEURS

/ CONNECTORS

- Tube carton / Carboard tube - 1 € - H 38,5 cm
- Avec connecteur / With link - 1,50 € - H 48cm

②

SIDE BOX

6 x 30 x H 38 cm

- Blanc / White - 12,50 € -
- Noir / Black - 16 € -

③

WINDOW BOX

55 x 30 x H 38 cm

- Blanc / White - 38 € -
- Noir / Black - 41 € -

④

FULL BOX

55 x 30 x H 38 cm

- Blanc / White - 29,50 € -
- Noir / Black - 33,50 € -



Événementiel, display, boutiques, stands, vitrines...

Events, stands, display systems, shop windows...



Impression possible pour personnalisation des boîtes.

Printing possible to customize the boxes.

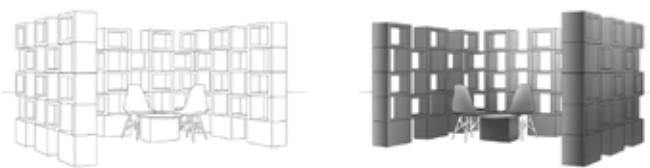

Leica
Geosystems



Paper
Box®
by PROCÉDÉS CHÉNEL
Architectures de papier



GERMAN
DESIGN
AWARD
GOLD
2016



Focus Open 2015
Gold
International Design Award
Baden-Württemberg



Green
Product Award
Winner 2015



Paper
Box®

by PROCÉDÉS CHÉNEL®
Architectures de papier



GERMAN
DESIGN
AWARD
GOLD
2016



Focus Open 2015
Gold
International Design Award
Baden-Württemberg



Green
Product Award
Winner 2015



MODULES

HONEYCOMB

MODULES



Honeycomb Modules vous permet de créer des parois courbes ou droites en superposant des modules.

Honeycomb Modules is a new solution to create vertical partitions straight or curved by stacking modules.



Classé non feu M1, B1, NFPA 701.

Fire ratings M1, B1, NFPA 701.

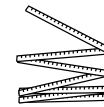

20 cm d'épaisseur et 35,7 cm de hauteur.

20 cm thick and 35,7 cm high.



- Cloison courbe ou plane
- Légère et élégante
- Diffusion des flux lumineux
- Bonne absorption phonique
- Très faible volume
- Pose facile
- Réutilisable
- Un large choix de couleurs

- *Curved or planed partition*
- *Light & Elegant*
- *Diffusion of light*
- *Good phonic absorption*
- *Low volume*
- *Easy set up*
- *Reusable*
- *International patents*

MODULES

HONEYCOMB

MODULES

Honeycomb modules



DISCOVERY HALL

1	2	3	4	5	6	7	8	9	10	11	12	13	14	15	16	17	18	19	20	21	22	23	24	25	26	27	28	29	30	31	32	33	34	35	36	37	38	39	40	41	42	43	44	45	46	47	48	49	50
---	---	---	---	---	---	---	---	---	----	----	----	----	----	----	----	----	----	----	----	----	----	----	----	----	----	----	----	----	----	----	----	----	----	----	----	----	----	----	----	----	----	----	----	----	----	----	----	----	----

WELCOME DESK

THE CONCIERGE

MODULES
HONEYCOMB
 MODULES



CLOISONS[®]
HONEYCOMB
PARTITIONS

CLOISONS[®]
HONEYCOMB
PARTITIONS



La cloison Honeycomb[®] est une nappe d'alvéoles en nid d'abeille pour partitionner l'espace.

Honeycomb partition[®] is a succession of honeycomb cells to make separations.



Classé non feu M1, B1, NFPA 701.

Fire ratings M1, B1, NFPA 701.

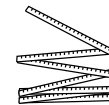

2 formats : 8 cm et 16 cm

2 different depth : 8 cm and 16 cm



- Cloison courbe ou plane
- Légère et élégante
- Diffusion des flux lumineux
- Bonne absorption phonique
- Très faible volume
- Pose facile
- 3 types de nappes disponibles
- Un large choix de couleurs
- Brevet international

- *Curved or planed partition*
- *Light & Elegant*
- *Diffusion of light*
- *Good phonic absorption*
- *Low volume*
- *Easy set up*
- *3 different dimensions*
- *A large range of colours*
- *International patents*



PIPE &

DROP PAPER
DROPSCREEN



Système de paravent autostable en Drop Paper®. En option, platine de stabilisation.

Self standing partition made of Drop Paper®, Optional: steel base with aluminium tube.



Classé non feu M1, B1, NFPA 701.

Fire ratings M1, B1, NFPA 701.

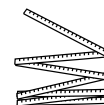

Hauteur 1m ou 2m, déployable jusqu'à 5ml, largeur environ 35cm.

1 or 2 m high, stretchable to 5 m, about 35 cm wide.



- Léger et élégant
- Facilité d'installation
- Diffusion des flux lumineux
- Bonne absorption phonique
- Très faible volume
- Un large choix de couleurs
- Possibilité d'impression de motifs
- Possibilité de découpe laser
- Brevet international

- *Light & Elegant*
- *Easy set up*
- *Diffusion of light*
- *Good phonic absorption*
- *Low volume*
- *A large range of colours*
- *Can be printed*
- *Can be laser cut*
- *International patents*

PIPE &

DROP PAPER
DROPSCREEN



PIPE & DROP
DROPPAPER
DROPSCREEN

Custom Pipe&Drop, showroom PCI



PIPE & DROP
DROPPAPER
DROPSCREEN



**LASER
DROP®**

LASER DROP®



Découpe sur Drop Paper® blanc ou couleur de tous motifs vectorisés, standards ou sur mesure.

Cut on white or coloured Drop Paper® of any vectorised, standard or custom design.



Classé non feu M1, B1, NFPA 701.

Fire rated M1, B1, NFPA 701.



Laser Drop® Anne-Lise Vernejoul / Photo Sophie Delaporte



PRODUIT
RHÔNE-ALPES
avec l'Association de
RhôneAlpes

GUILLOT
COBRED A
Le Puy de
Foucault

GUILLOT
COBRED A
24 06

GUILLOT
COBRED A
24 06

GUILLOT
COBRED A
24 06

PRODUIT
RHÔNE-ALPES
avec l'Association de
RhôneAlpes

Valans

LASER
DRO P

® Laser Drop, SIRAH exhibition in Lyon, Design X'PO



LASER
DROP®



LIGHTED WALL

LIGHTED WALL

CLOISON EN PAPIER AUTOSTABLE JUSQU'A 5 METRES !

Système de cloison en papier avec structure intérieure permettant une hauteur de 5 mètres.

La structure métallique intérieure permet l'installation de l'éclairage et sa diffusion par les écrans en papier Drop Paper® imprimables, suspendus et lestés en partie basse.



SELF STANDING PAPER WALL UP TO 5 METERS HIGH

Modular system to build self standing illuminated paper partitions up to 5 m high.

The structure enables lighting to be set up inside, which is diffused by the Drop Paper® screens, printable, hung and weighted.



Classé non feu M1, B1, NFPA 701.

Fire rated M1, B1, NFPA 701.

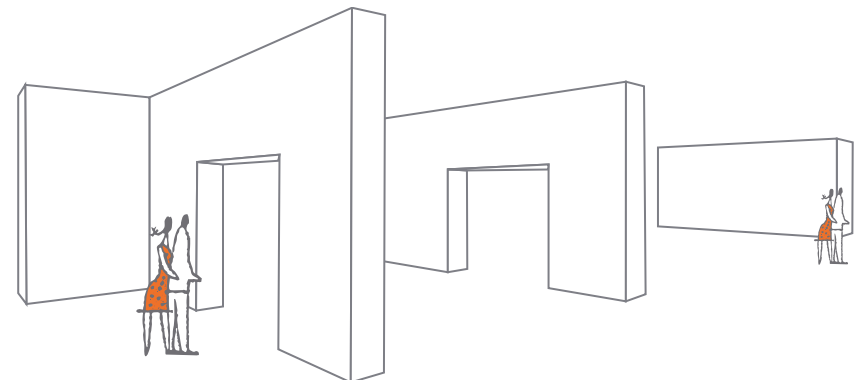



GROW UP by FLAVIE+PAUL

GROW UP by FLAVIE+PAUL

Conçu par Flavie+Paul pour Procédés Chénel International, Grow up est une cloison en papier, ré-interprétation du mur végétal. Des motifs végétaux pré-découpés sont juxtaposés les uns sur les autres. Un mur de papier pourvu d'interstices en forme de croix vient les recouvrir. En passant sa main au travers des croix, l'utilisateur attrape les végétaux et les fait ressortir sur l'avant du mur. L'utilisateur vient ainsi composer son mur suivant ses besoins et envies : il le modifie, le grandit, l'épaissit, le fait foisonner. Grow up est composé de modules qui peuvent facilement s'adapter à plusieurs types d'espaces, tant dans un but séparatif que décoratif.



Designed by Flavie+Paul for Procédés Chénel International, Grow up is a paper partition wall, re-interpretating the idea of a vegetal wall. Pre-cut vegetal patterns are juxtaposed and placed behind a paper wall which has several cross-shaped cut. The user is then free to grasp the vegetal patterns through the cuts and bring them up front. The wall is therefore each time unique, made up depending on the user's desires. Grow up consist of modules, which can easily fit to many spaces, being a partition as well as a decoration.



Classé non feu M1, B1, NFPA 701.

Fire rated M1, B1, NFPA 701.





KIRIGAMI

design Janique Bourget

3 rails coulissants parallèles

3 panneaux Drop® suspendus dim. 1,50 m x 2,35 m de hauteur

Plat aluminium et étiré de lestage en partie basse

Découpages 1,20 m x 0,60 m



Parallel sliding rails

3 suspended Drop® panels, dim. 1,50 x H2,35m

Flat aluminium profile and ballast at the bottom

Cutting up 1,20 x 0,60m



Classé non feu M1, B1, NFPA 701.

Fire rated M1, B1, NFPA 701.

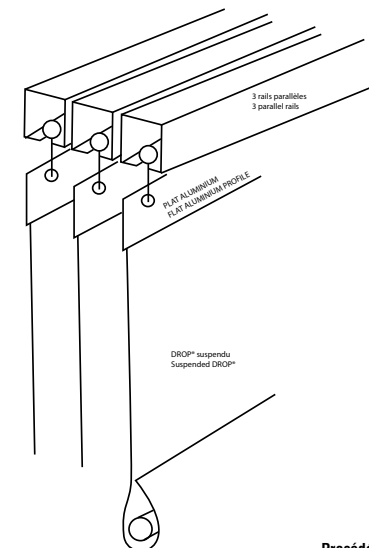
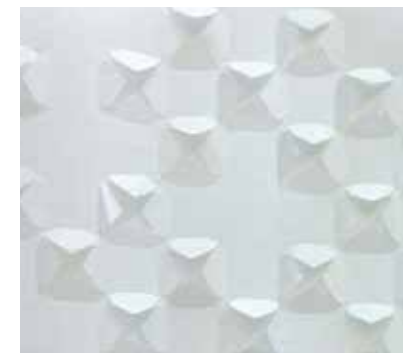

KIRIGAMI

design Janique Bourget



Cloison
AirDROP®
Partition Wall

Cloison AirDROP® Partition Wall

Cloison ajourée

- Dimensions : 0,80 m de largeur x hauteur variable jusqu'à 3,50 m environ.
- 3 modèles standards, possibilités de perforations de formes différentes.
- Système d'accrochage simple, tube aluminium et lestage inox.
- 15 couleurs standards.



Openwork Origami partition wall

- Dimensions: 0.80m width x up to 3.50m approximately in height.
- 3 standard references, various types of perforations possible.
- Simple hanging system, aluminium tube and stainless steel ballasting.
- 15 standard colors.

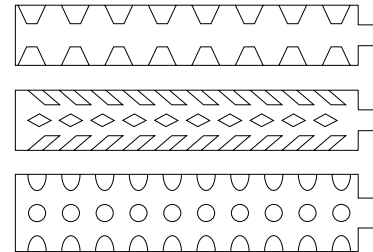



IGLOO



Une succession d'écrans découpés selon le motif désiré.
A succession of cut screens, any design possible.



Classé non feu M1, B1, NFPA 701.
Fire rated M1, B1, NFPA 701.

IGLOO



Conception Nadia Lauro.
Projet "La Clairière" pour "Un nouveau festival" au centre Pompidou



Carrousel du Louvre, design by Pascale Rabaud, architecte dplg

LUMINAIRES

LIGHTING



LIGHTED DROP®

LES LUMAIRES EN PAPIER

Éléments lumineux décoratifs en papier de formes et dimensions variables en Drop Paper® classés non feu M1, autostables ou suspendus. L'éclairage intérieur du luminaire en papier peut être créé par des fluos de couleur pour obtenir toute une variété de nuances. Disponibles en vente et location.



VARIETY AD INFINITUM OF PAPER LIGHTINGS

Decorative illuminated elements made of Drop Paper® of various shapes and sizes, fire retardant, hung or self-standing. Coloured fluo tubes add a large range of lighting effects. Available for purchase or rent.

LIGHTED DROP®

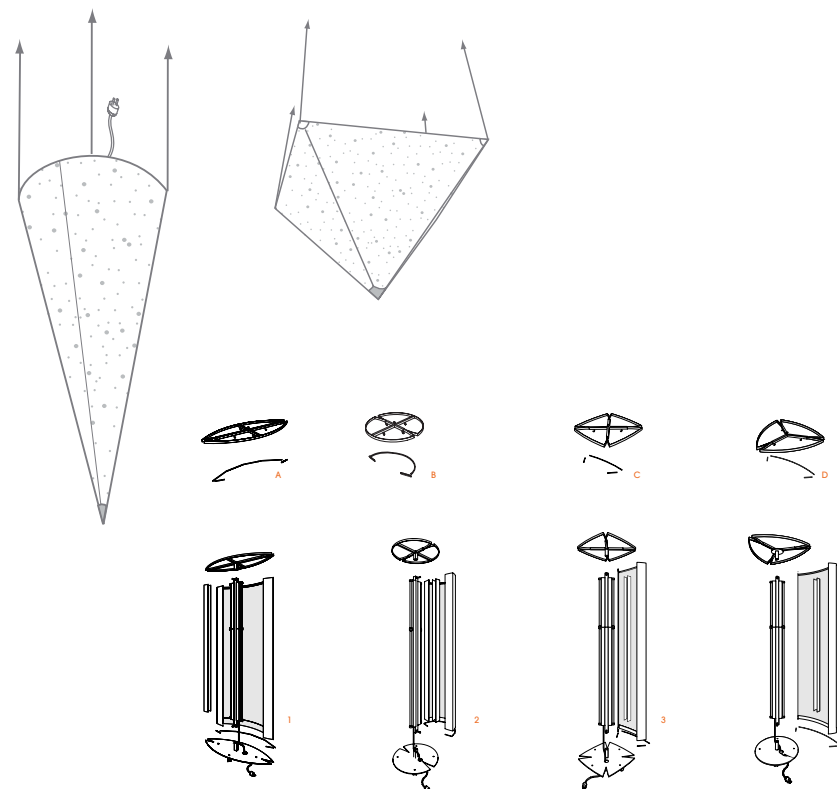



L I G H T E D
D R O P[®]

Grand Café d'Orléans au Château de Versailles
Design Atelier Canal



LIGHT COLUMN

By Procédés Chénel® International

LIGHT COLUMN

By Procédés Chénel® International



MONTAGE EXPRESS !

Élément lumineux en PVC transparent, recouvert d'un visuel interchangeable.

EXPRESS SET UP

Illuminated element made of transparent PVC transparent, covered with exchangeable graphics.

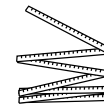

Existe en 2m et 2,35m de haut et version mini (35cm de haut).

Exists in 2m00 and 2m35 high and a mini version (35cm high).



LIGHT COLUMN
By Procédés Chénel® International



LIGHT MODULES

design by Ralston&Bau

LIGHT MODULES est un système d'éclairage en papier permettant de créer plafonds et éléments lumineux monumentaux sur-mesure pour des espaces permanents et provisoires. L'utilisation du papier apporte une grande légèreté d'installation tout en diffusant subtilement la lumière.

LIGHT MODULES permet de transformer un plafond en une installation dynamique et lumineuse. Les trois tailles de cadres et les hauteurs variables du papier permettent de créer une quantité infinie de plafond en 3 dimensions et de multiples lustres.

Quatre combinaisons standard d'installation sont illustrées dans ce document.

La structure est composée de cadres en aluminium puis fixée ou suspendue au plafond. Les abat-jours sont faits en Drop Paper, papier durable et non inflammable.

Le Drop Paper existe en plusieurs couleurs, épaisseurs et peut également être imprimé de tout motif.



LIGHT MODULES is a paper lighting system creating monumental on-measure lighting and ceiling for permanent and temporary spaces. Using paper gives large installations lightness and softly diffuse the light in the interior.

The simple Light Modules system make the ceiling into a living and lit-up installation. The three module sizes and the adjustable height of each module, makes it possible to create an endless amount of 3 Dimensional ceiling landscape and chandelier designs. On the following pages you can discover four basic combinations possible to make.

The system grid is made of aluminium and is attached onto or hanging from the ceiling and the shades are made out of Drop Paper that is a durable and fire proof paper. The Drop Paper comes in several colours, thicknesses and can also be printed with any pattern.

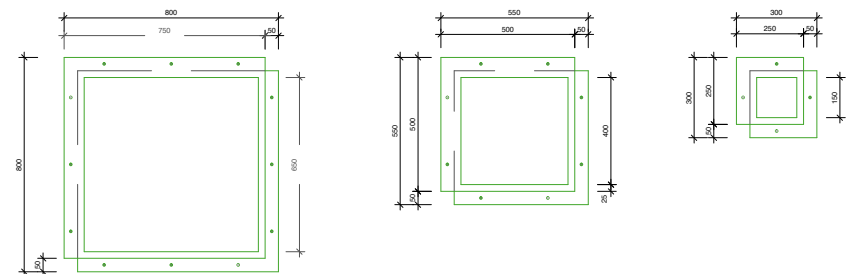

3 cadres en aluminium sont disponibles / 3 aluminium frames are available

LIGHT MODULES

design by Ralston&Bau

LASER LIGHT®



Abat-jour transparent résistant au fil incandescent à 180°C, habillé de Drop Paper® découpé selon motif standard ou personnalisé.

Lamp shade, resistant to 180°C incandescent wire, covered with cut Drop Paper®. Standard or custom design.



LASER LIGHT®





DAISY
design K-now

DAISY

design K-now

Luminaire prêt à suspendre en honeycomb.

Eclairage LEDs.

Dimensions :

- 50 x 11,5 cm
- 80 x 15 cm
- 100 x 15 cm



Ready-to-hang lamp, using Honeycomb.

LED lights.

Dimensions :

- 50 x 11,5 cm
- 80 x 15 cm
- 100 x 15 cm

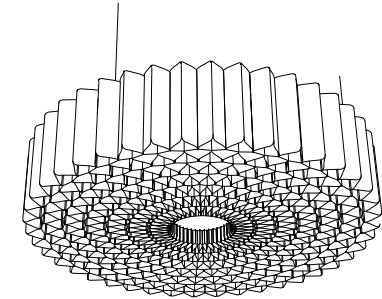
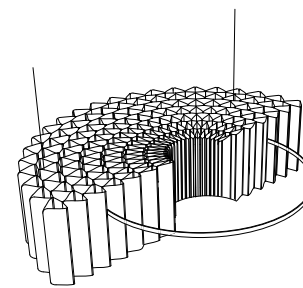



LAMPE
Canopy

LAMPE *Canopy*

- Design : Grégoire Belot
- Origami Drop®, blanc ou imprimé
- M1, B1
- Diamètre : 95 cm ou 75 cm
- Prêt à suspendre



- *Design: Grégoire Belot*
- *Origami Drop®, white or colored*
- *Flame retardant*
- *Diameter: 95 cm ou 75 cm*
- *Ready-to-use*





MOBILIER

FURNITURE



MOBILIER

®

HONEYCOMB

FURNITURE

Une table en papier, Drop Paper plié et collé en nid d'abeilles selon notre technique industrielle Honeycomb.

Épingle de jonction amovible.

Légère et élégante

Facilité d'installation

Diffusion des flux lumineux

Très faible volume

Un large choix de couleurs

Tables rondes, 3 diamètres : 2,60 m, 1,20 m et 0,60 m

3 hauteurs : 0,80 m, 0,60 m et 0,40 m

Plateau en plexi en option



Removable connecting pin.

Light and Elegant

Easy set up

Diffusion of light

Low volume

A large range of colours

Round table : 3 diameters : 2,60 m, 1,20 m et 0,60 m

3 heights : 0,80 m, 0,60 m et 0,40 m

Optional plexi top table



MOBILIER

®

HONEYCOMB

FURNITURE



MOBILIER

®

HONEYCOMB

FURNITURE



MOBILIER

®

HONEYCOMB

FURNITURE



MOBILIER

®

HONEYCOMB

FURNITURE

Honeycomb Modules vous permet de créer des comptoirs en papier en superposant des modules de 40 cm d'épaisseur et 35,7 cm de hauteur sur une structure simple en tube carré laqué.

Ces comptoirs peuvent être lumineux par simple ajout de tubes fluo de 75cm de hauteur.

Finition en partie haute par une plaque en plexi à fixer sur la structure.



Honeycomb Modules is used to make counters. Simply stack different modules of 40 cm thick by 35,7 cm high onto a structure made of white square tube.

*These counters can be lighted with 75cm fluo tubes inside.
Then we place on the top a plexi board simply fixed to the structure.*





LUMIBAR

COMPTOIR LUMINEUX

Meuble en pmma diffusant pour réaliser des bars ou des accueils personnalisés. La surface lisse permet tout type de marquage en façade. L'éclairage intérieur peut être coloré en trichromie.

Dimensions : 0m50 x 1m50 de long x 1m10 de hauteur.

TABLE BASSE LUMINEUSE

Mobilier en pmma diffusant permettant la réalisation d'espaces réceptifs de qualité.

Dimensions : 0m70, x 0m70 x 0m50 de hauteur.



LIGHTING FRONT DESK

Furniture made of acrylic to make a customised front desk.

The smooth surface enables any front signage (with vinyl graphic). The inside lighting device can work in red, green and blue systems, allowing many colour variations.

Dimensions: 0,50 m x 1,50 m x 1,10 m high

LIGHTING COFFEE TABLE

Furniture made of acrylic to make a customised coffee table.

Dimensions: 0,70 m x 0,70 m x 0,50 m high





LUMIBAR

DROP SEAT



Fauteuil «club» en PVC transparent rempli de copeaux en papier ou en carton recyclé.

Club armchair made out of transparent PVC, filled with paper or recycled cardboard strips.



DROP SEAT



STOOLY



Tabouret pliable et dépliable à l'infini, en carton et disponible 8 couleurs : 4 Stooly Classics (blanc, marron, rouge, noir) et 4 Stooly Pop (jaune, orange, bleu vert) et en 4 tailles: 28, 35, 42 ou 50 cm de haut.

Stool that can be folded and unfolded to infinity, in cardboard and available in 8 colors: 4 Stooly Classics (white, brown, red, black) and 4 Stooly Pop (yellow, orange, blue green) and in 4 sizes: 28, 35, 42 or 50 cm high.



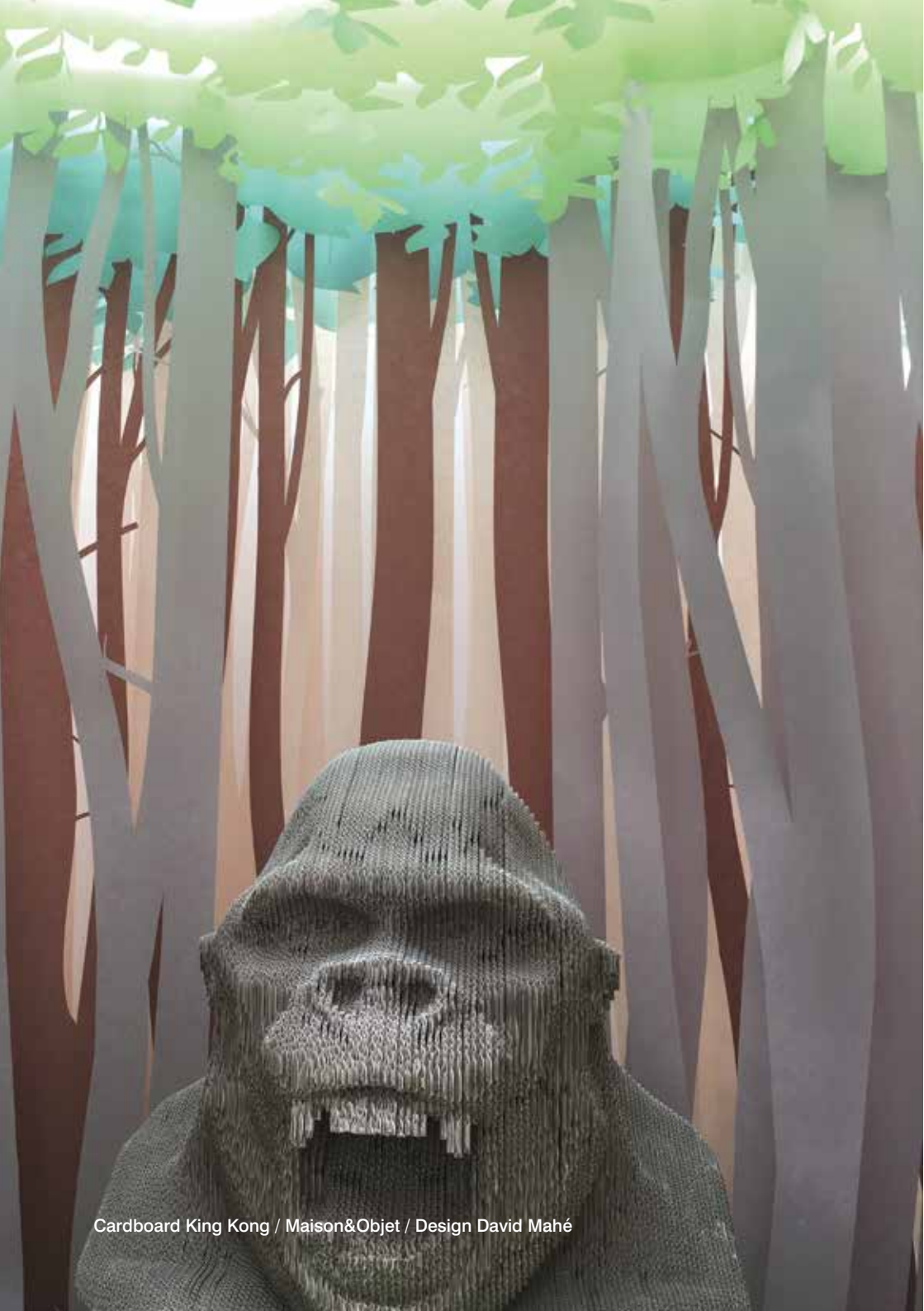

ACCESSOIRES

ACCESSORIES

Cardboard King Kong / Maison&Objet / Design David Mahé



PAPER TREE

PAPER TREE



Arbre en PMMA alvéolaire M2 découpé
avec guirlandes de feuilles en Drop Paper M1.
Livré à plat. H 2,50 m

*Cut tree in alveolar acrylid with garlands of leaves made with Drop Paper M1.
Delivered flat. H 2,50 m*

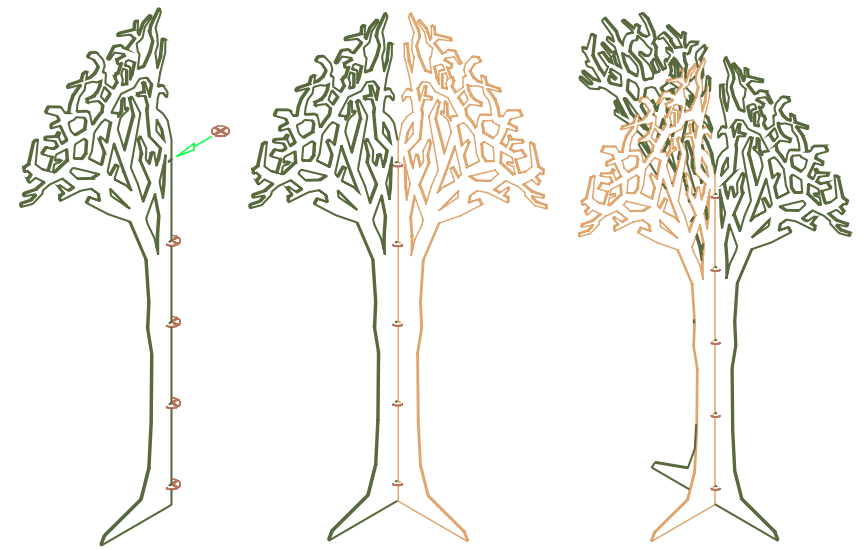



SAPIN / FIR TREE

MOTIF CHRISTMAS / CHRISTMAS PATTERN

Structure transparente conique en 3 parties, livrée à plat et à assembler.
Base de 0,90 m de diamètre, hauteur 2,20 m. Eclairage par tube fluorescent de 2,08 m.



Recouvert de Drop Paper blanc diffusant et d'un autre Drop découpés avec tout type de pattern.

*Transparent cone structure in 3 parts, delivered flat and ready to assembly.
Base : 90 cm diam, 2,20 m high, Lighting with a fluorescent tube of 2,08 m high.
Covered with a white diffusing Drop Paper and another one on top cut with any design.*





SAPIN ÉTOILE / STAR FIR TREE

DESIGN OLIVIA MARTIN / DESIGN OLIVIA MARTIN



Sapin origami en kit à monter soi-même, autostable avec un tube fluo.
Existe en hauteur 0,80 m, 1,30 m ou 1,80 m
Standard Drop Paper® blanc 80g

*Origami fir tree, in kit form, to be put together. Stable, with a fluorescent tube.
Height 0,80 m, 1,30 m or 1,80 m*



SAPIN ÉPURE / EPURE TREE

DESIGN OLIVIA MARTIN / DESIGN OLIVIA MARTIN

Sapin origami en kit à monter soi-même, autostable avec un tube fluo.
Existe en 0,90 m de hauteur.
Drop Paper® 80g ou PERFO DROP®



*Origami fir tree, in kit form, to be put together. Stable, with a fluorescent tube.
Available in 0,90 m in height.
Drop Paper® 80g or PERFO DROP®*

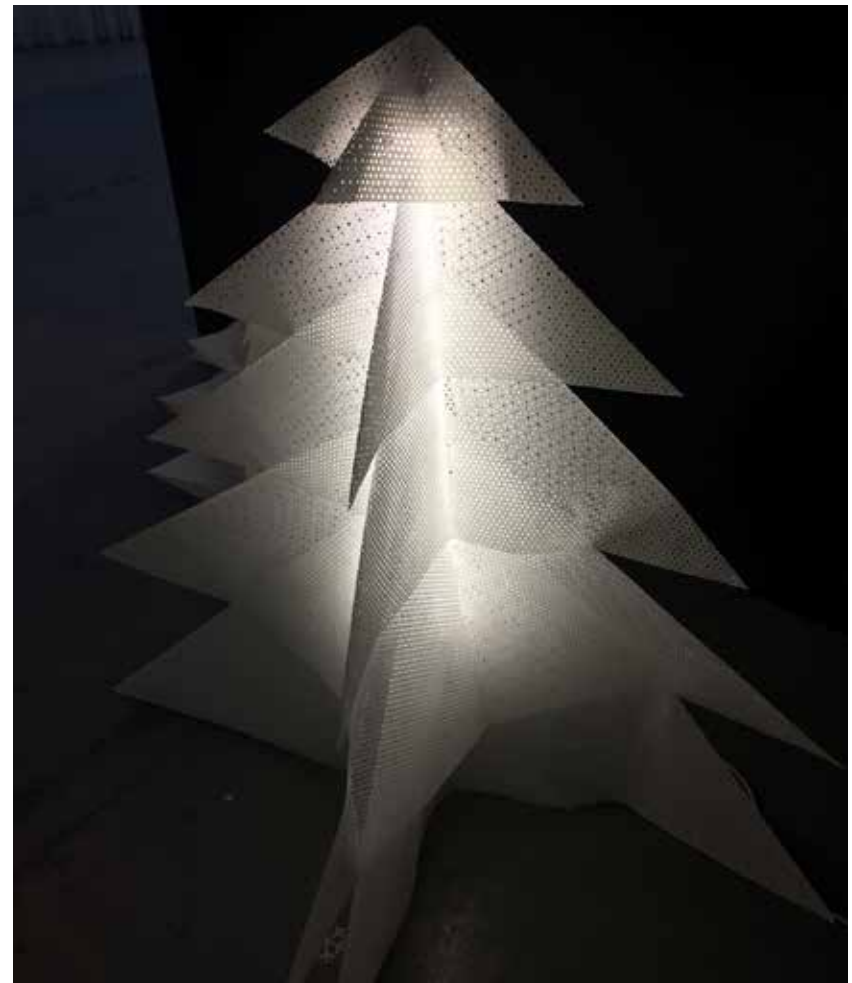

MOMINOKI / MOMINOKI

DESIGN LIKA KATO / DESIGN LIKA KATO

Sapin origami en kit à monter soi-même, autostable avec un tube fluo.

M1

Existe en 0,80 x 1,30 m et 0,60 x 0,95 m.

Origami fir tree, in kit form, to be put together. Stable, with a fluorescent tube.

Fire retardant M1

Available in 0,80 x 1,30 m et 0,60 x 0,95 m.





GUIRLANDE LUNAIRE MOON GARLAND

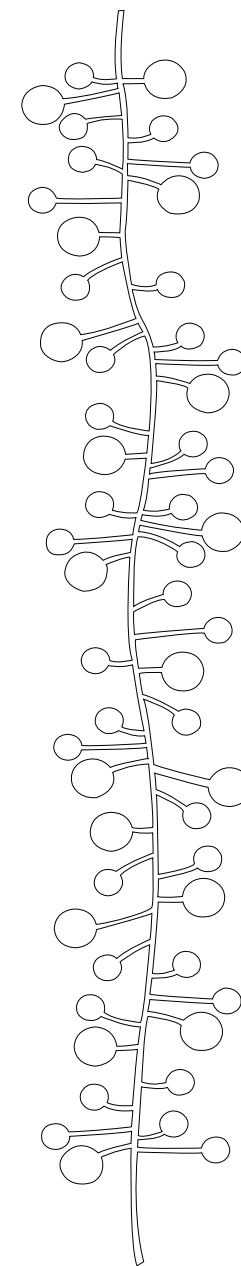



GUIRLANDE ÉRABLE MAPLE GARLAND

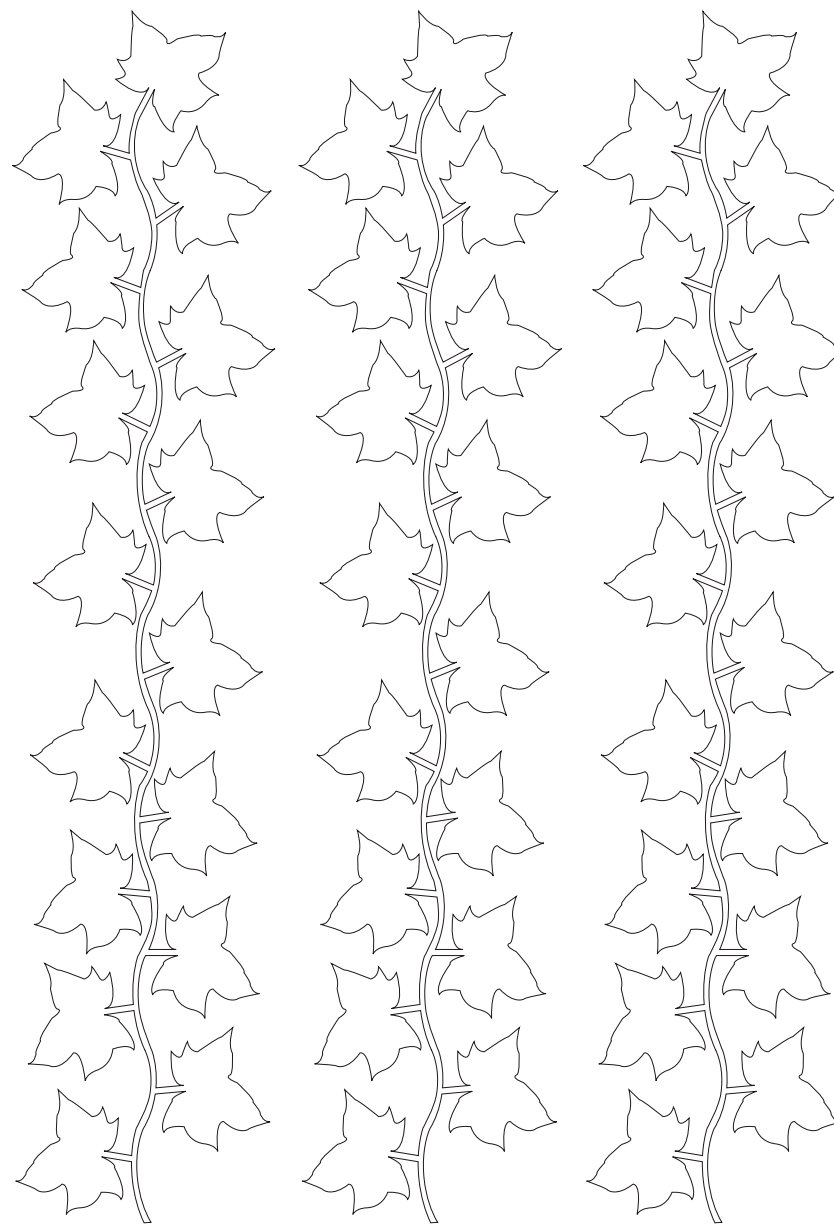



GUIRLANDE ACACIA

ACACIA GARLAND

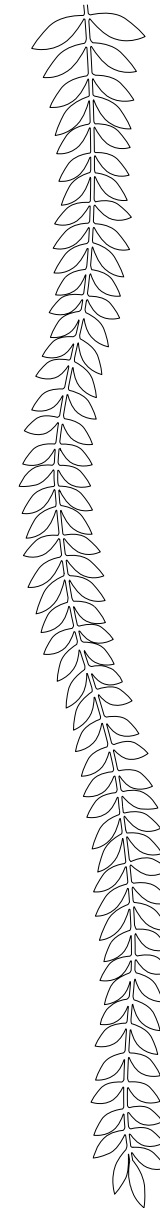
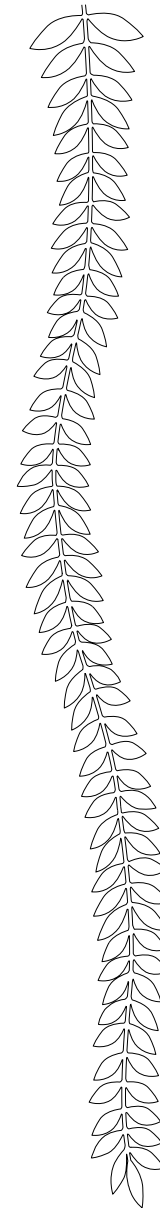
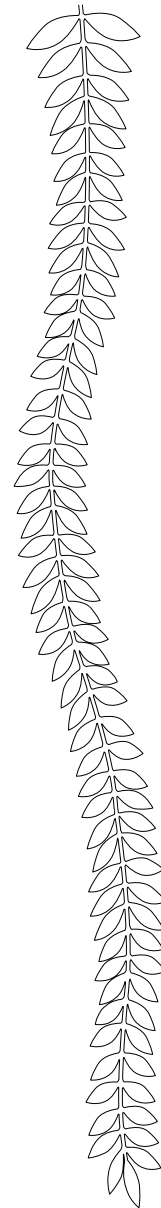



ARCH



Hauteur : 2,30 m
Longueur : 1 ml ou 2 ml (dans l'image 2ml)
Ouverture : 2,04 m
Plat acier avec tube manchonnés, peinture blanche.

*Height: 2.30m
Length: 1ml or 2ml (in the image, 2ml)
Aperture: 2.04m
Flat steel profiles, with connecting sleeves, white paint.*

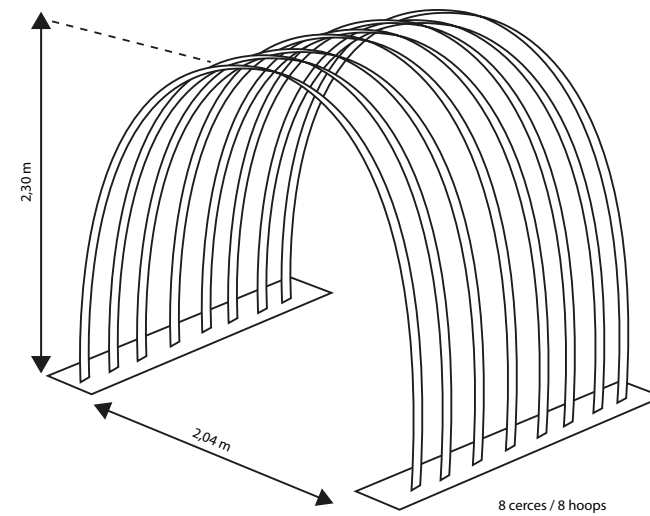



FLOWERS



Fleurs en Drop Paper sur tige 15 cm de diam.

Flower made of Drop Paper on stem, 15 cm diam.



Camélia



Élébore



Pivoine



Clématite



Dahlia



Rêve d'été



ROSA

UN EXEMPLE DE NOUVELLE VIE POUR DES CHUTES DE PAPIER

AN EXAMPLE OF A NEW LIFE FOR PAPER WASTE!

Suite à un workshop à l'École de Design de Rennes basé sur l'utilisation de la matière contenue dans les boîtes Mystère Green de Procédés Chénel, Michelle Bonny, l'une des étudiantes, a créé Rosa, un système de fabrication de petites roses de différentes dimensions.

Ces petites roses permettent de facilement récupérer beaucoup de chutes de papier, et Procédés Chénel a décidé de lancer cette collection de fleurs prêtes à divers emplois, en en confiant la confection à des détenues.

Following a workshop led by Rennes Design School, which was focusing on using the material the Procédés Chénel's Mystère Green boxes actually contain, Michelle Bonny, one of the students, came up with this idea of manufacturing roses.

These small flowers make it easy to upcycle many paper waste, and Procédés Chénel has decided to launch a collection of these flowers, trusting prisoners with their manufacturing.



DROP PAPER® M1,

FLAME RETARDANT
DROP PAPER®



DROP FRUITS



Pommes et poires en nid d'abeille ou en simples écrans suspendus, à poser ou à suspendre.
Couleurs et dimensions variables.

*Apples and pears made out of honeycomb or simple suspended screens, which can either be hanged or put down.
Colors and dimensions can adaptable.*



STANDING FLOWERS

Platine acier avec manchon 28 cm x 28 cm
La platine peut avoir une couleur de Drop® selon la gamme.
Tube aluminium diam. 25 mm
Hauteur de la fleur : 1 m
Envergure de la fleur + ou -35 cm



*Steel base with sleeve 28x28cm
The base can have a color from the Drop® collection
Aluminium tube diam. 25mm
Height of the flower: 1m
Wigspan of the flower approx. 35cm*





design Emmanuelle Durville

ROCKS & CLOUDS



Nuages et rochers en Drop Paper®
Dimensions et couleurs sur demande

*Rocks and clouds made out of Drop Paper®
Dimensions and colors upon request*



design Emmanuelle Durville + Maud Sarolles



JELLY FISH

design Lika Kato



Méduses en Honeycomb de Drop Paper®
Dimensions et couleurs sur demande

*Jelly fishes made out of Drop Paper® Honeycomb
Dimensions and colors upon request*



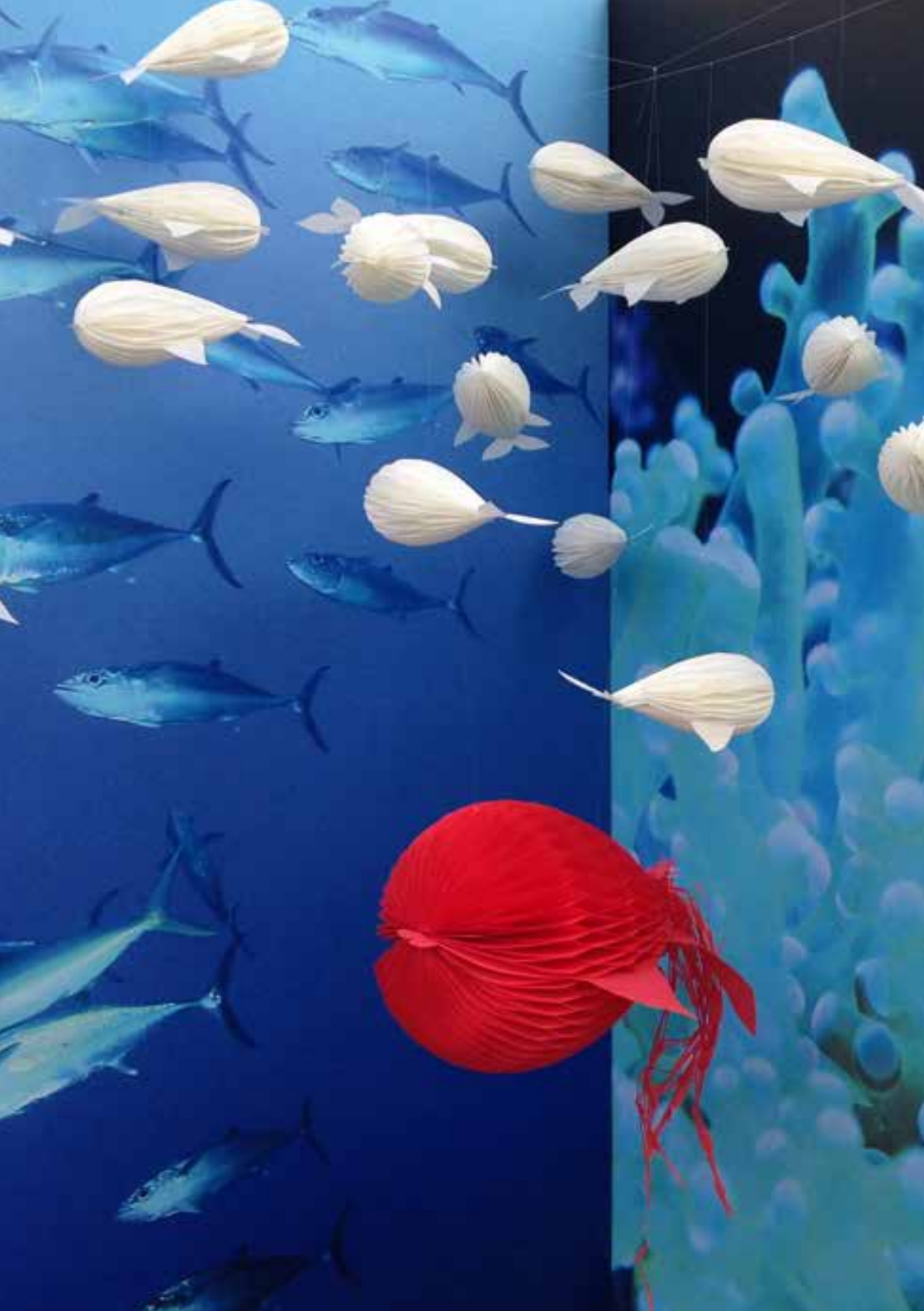

FISH

design Lika Kato



Poissons en Honeycomb de Drop Paper®
Dimensions et couleurs sur demande

*Fishes made out of Drop Paper® Honeycomb
Dimensions and colors upon request*





DOVE

design Lika Kato



Colombes en Honeycomb de Drop Paper®
Dimensions et couleurs sur demande

*Doves made out of Drop Paper® Honeycomb
Dimensions and colors upon request*



PHOTOPHORES



Photophores en Perfo Drop®
Dimensions et couleurs sur demande

*Candle holders made out of Perfo Drop®
Dimensions and colors upon request*

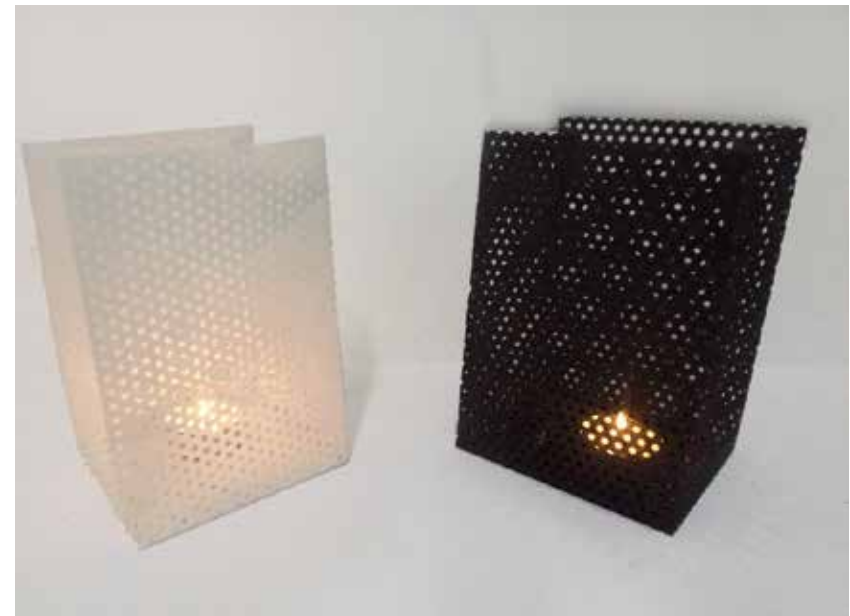



ETC.

Les designers ne manquent pas d'audace...
A selection of daring designers' projets



Shiatzy Chen Fashion Show / Autumn/Winter collection / Grand Palais, Paris
by "La Mode en Images"





PatchWork by Anne-Lise Vernejoul
Caisse des dépôts event, Carrousel du Louvre, Design Auditoire



Brise soleil en Drop, design Ora-ïto

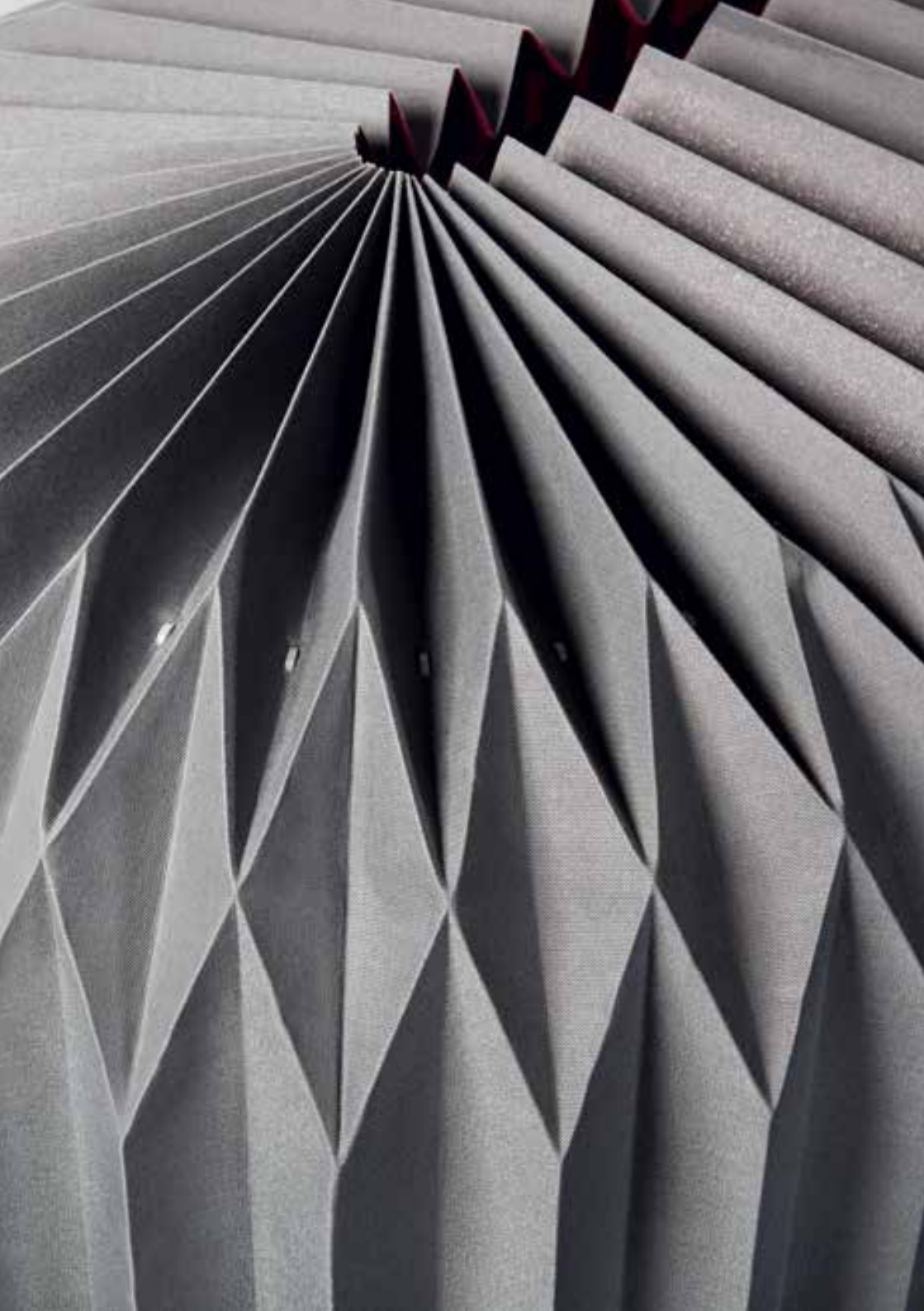

Vestiaire Silex, design Jean-François Bellemère



Design by Matali Crasset





Fleurs de Paris, Royal Monceau, Design : Manymany



Drop Paper® wastes from the Mystery Box / Festival We Love Green



Laser Drop® / Food Temple / Carreau du Temple, Paris / Design Studio Ravages



LES SONNETS D'UN MONDE A JAMA...

ANGELINI...
DE LA MUSIQUE...

Musique M...



PROCÉDÉS CHÉNEL[®] MTL.
Architectures de papiers

70, rue Jean Bleuzen
92170 Vanves
France

T : +33 (0)1 41 08 76 76
F : +33 (0)1 41 08 01 53
info@chenel.com
www.chenel.com

January 2021

DROP STRIPE[®] CEILING / Grand Central Saint Lazare
Architect: FERRIER MARCHETTI STUDIO / Interior Architect: CALQ