



SECRET JARDIN

ASSEMBLY  
INSTRUCTIONS

Revision 2.50

- Secret Jardin DARKROOM
  - DR60 p. 4 - 5
  - DR90 p. 6 - 7
  - DR120 p. 8 - 9
  - DR150 p. 10 - 11
  - DR240 p. 12 - 13
  - DR300 p. 14 - 15
  - DR150W p. 16 - 17
  - DR240W p. 18 - 19
  - DR300W p. 20 - 21
- Secret Jardin DARKSTREET
  - DS60 p. 22 - 23
  - DS90 p. 24 - 25
  - DS120 p. 26 - 27
  - DS150 p. 28 - 29
  - DS120W p. 30 - 31
- Secret Jardin VINTAGE
  - V100 p. 32 - 33
- Secret Jardin TWIN
  - T60 p. 34 - 37
  - T90 p. 38 - 41
- Secret Jardin DARK PROPAGATOR
  - DP90 p. 42 - 43
  - DP120 p. 44 - 45
- Secret Jardin CRISTAL
  - CR60 / CR110 / CR145 p. 46 - 47
- Secret Jardin DARK DRYER
  - DD90 p. 48 - 49
- Secret Jardin LODGE
  - L90 p.50 - 51
  - L120 p.52 - 53
  - L160 p.54 - 55
  - L280 p.56 - 59
- Secret Jardin ORCA GROW TENT
  - OR120 p.60 - 61
  - OR240W p.62 - 63
  - Tent composition p.64 - 65
  - Tent Configuration Advised p.66 - 67



Thanks you for purchasing a  
Secret Jardin tent.

We wish you a great growing



Assembled in a few minutes



One person required



No tool needed

## DR60

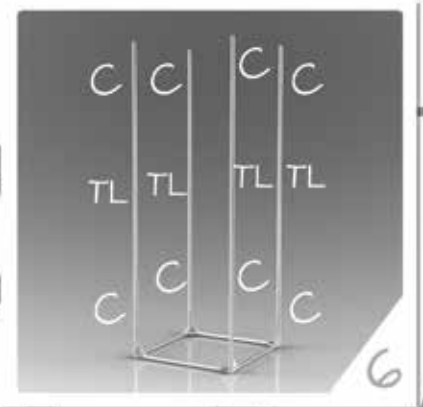
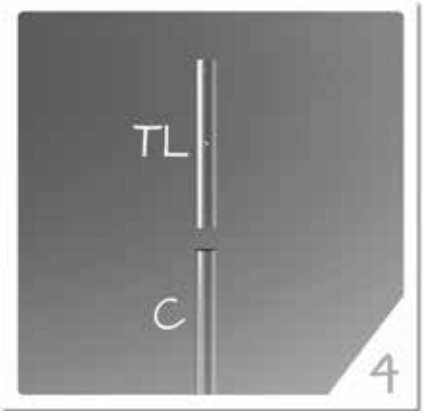
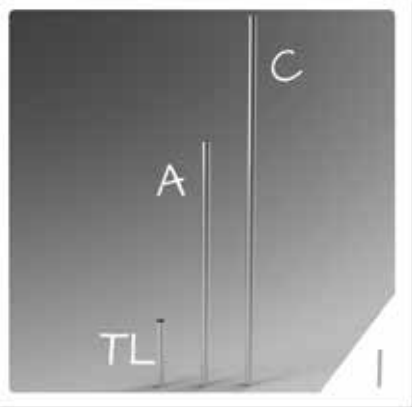



SECRET JARDIN



7



8



9

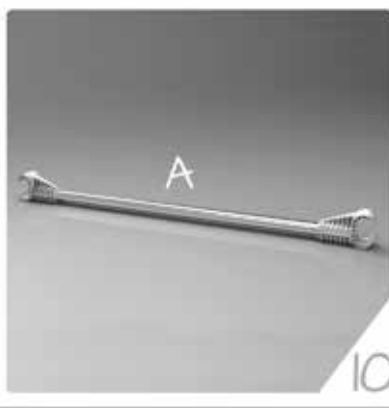

10



11

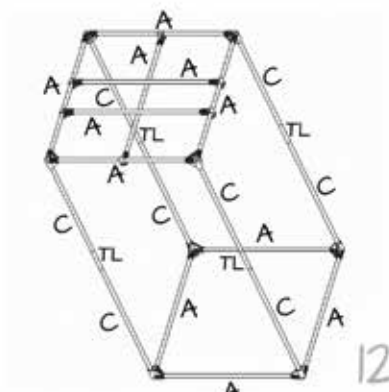

12

DARK ROOM

## DR90

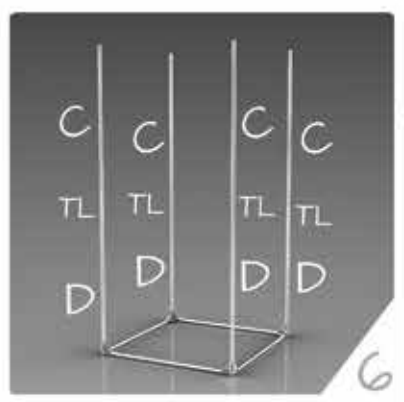
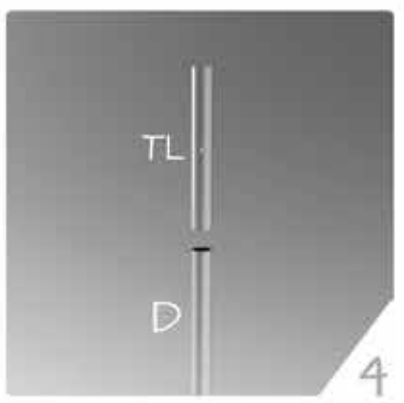
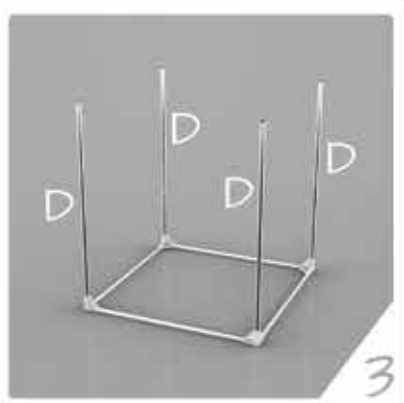
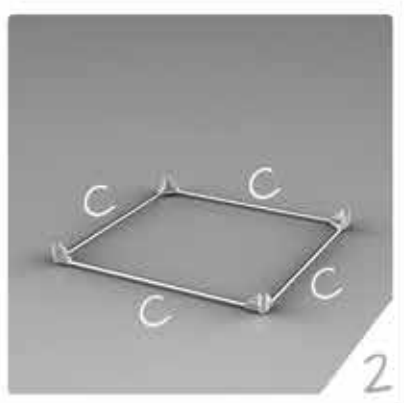



SECRET JARDIN

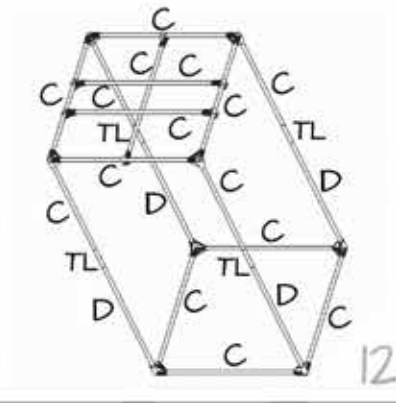

DARK ROOM

## DRIZO

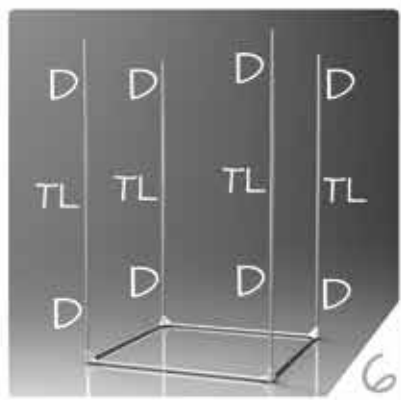
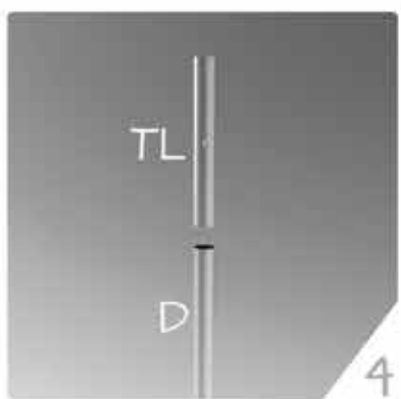
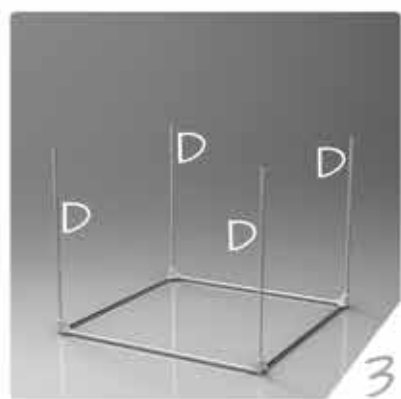
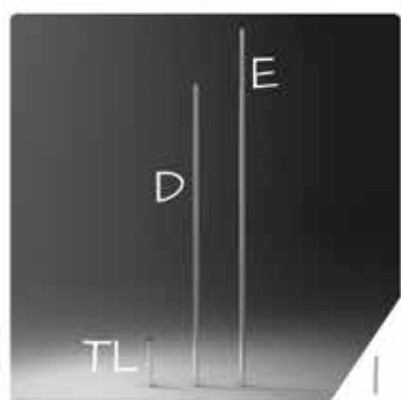





SECRET JARDIN

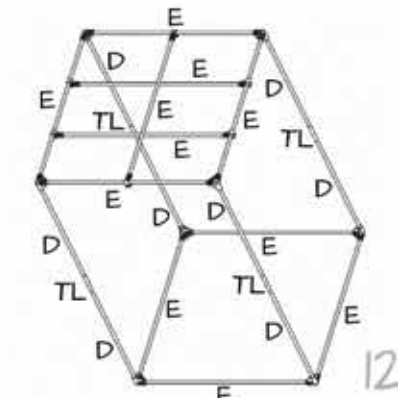
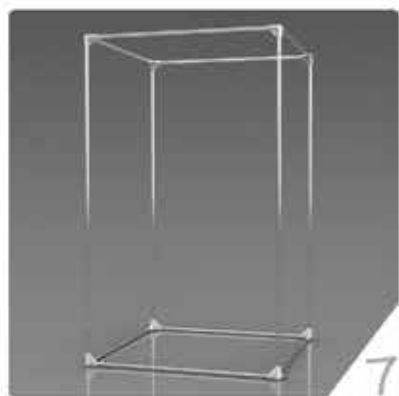

DARK ROOM

## DRISO

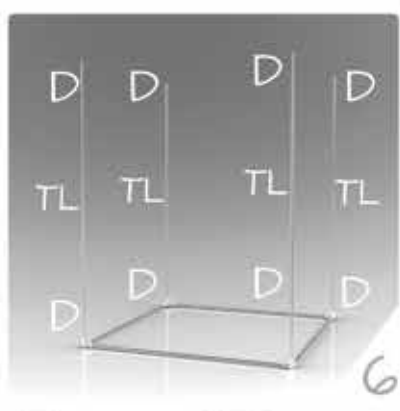
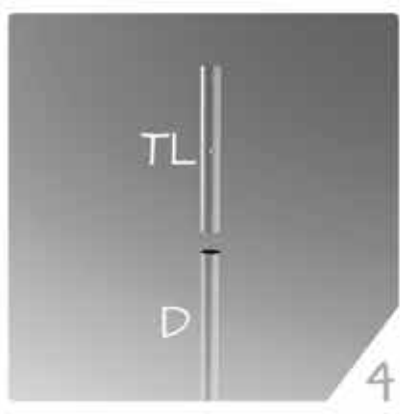
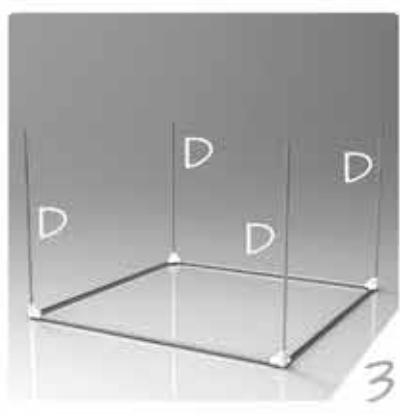
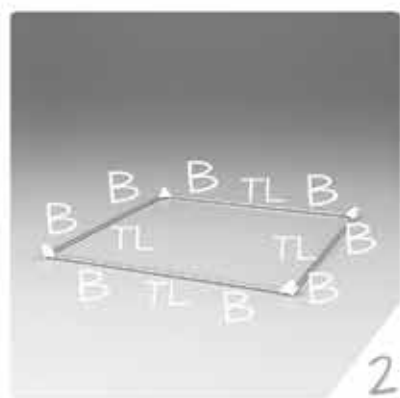
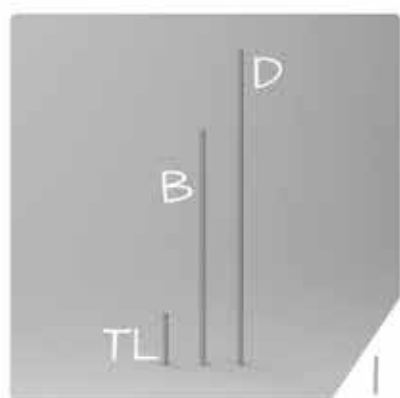



SECRET JARDIN

II

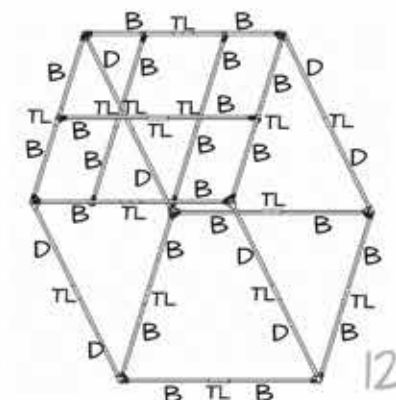
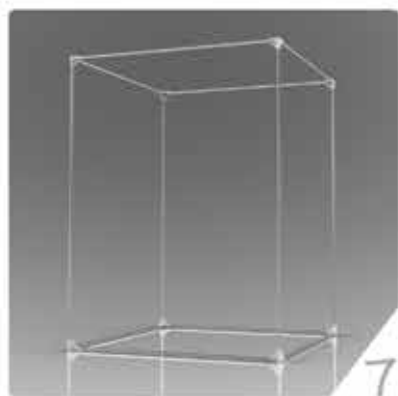

DARK ROOM

## DR240

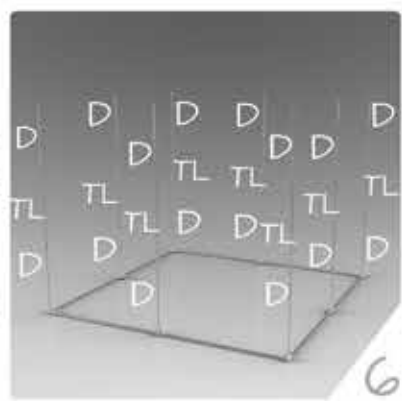
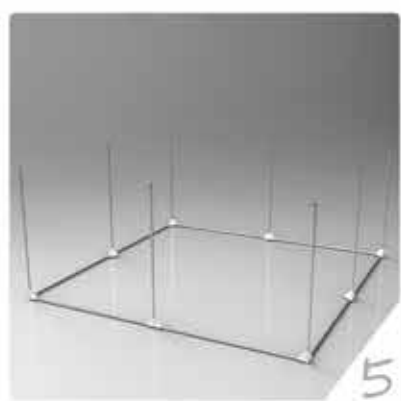
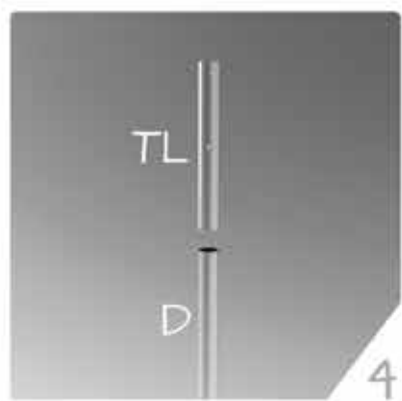
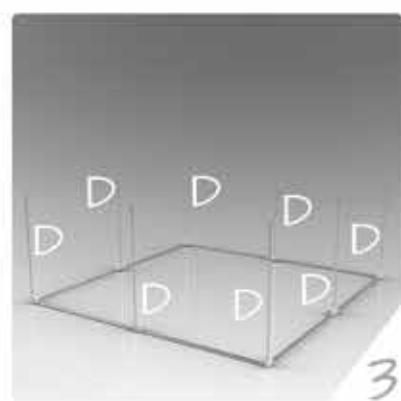
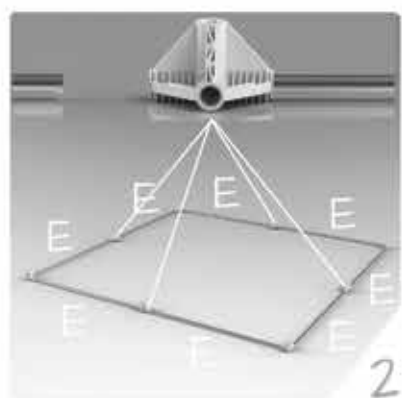
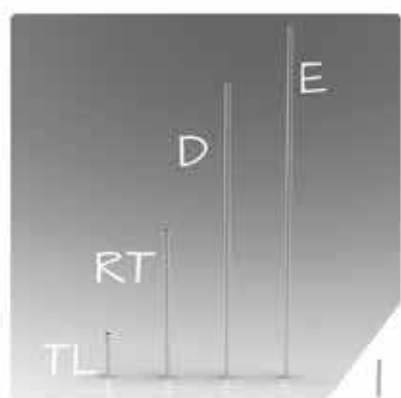



SECRET JARDIN

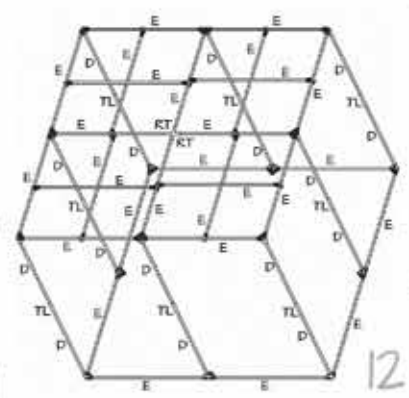

DARK ROOM

## DR300

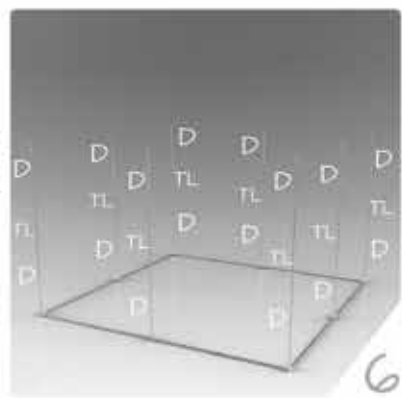
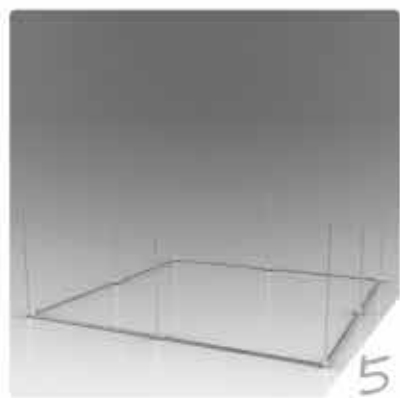
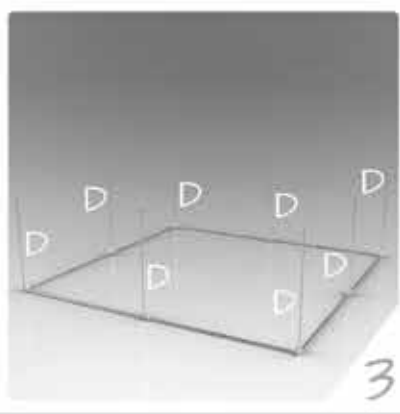
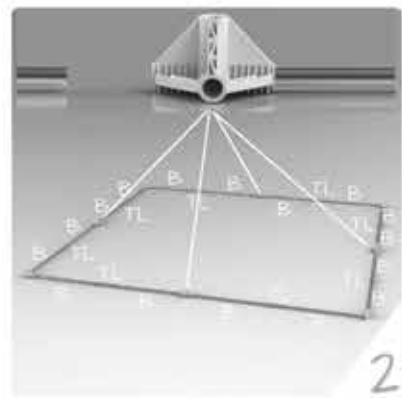
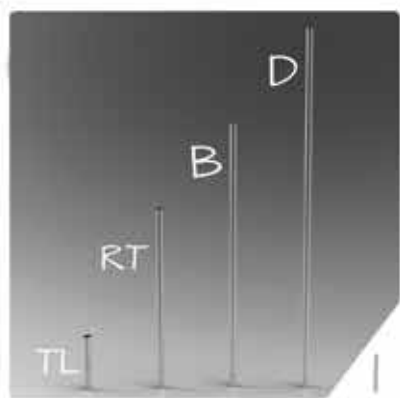



SECRET JARDIN

DARK ROOM

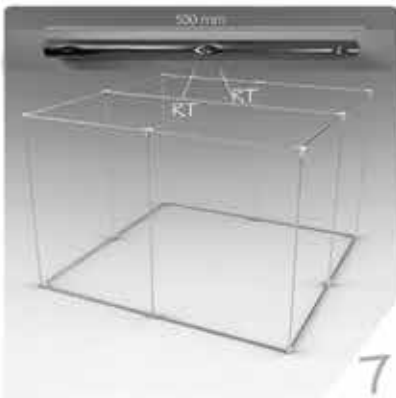

7



8



9

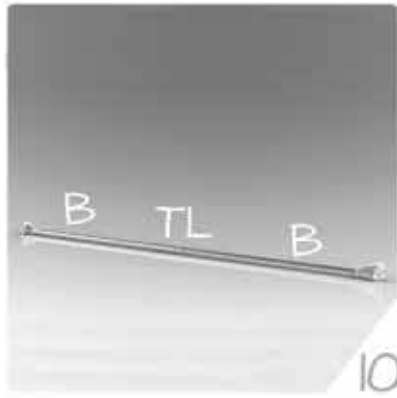

10



11

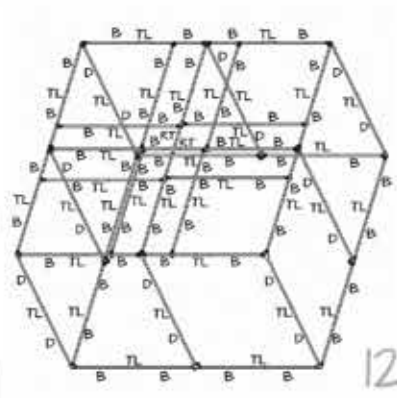

12

## DRISOW

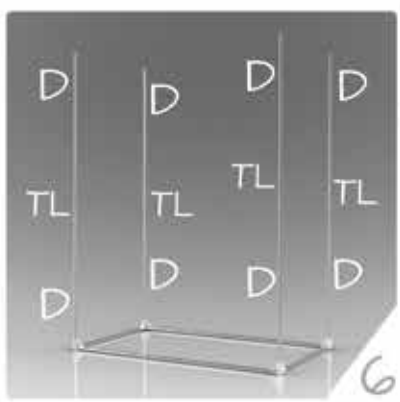
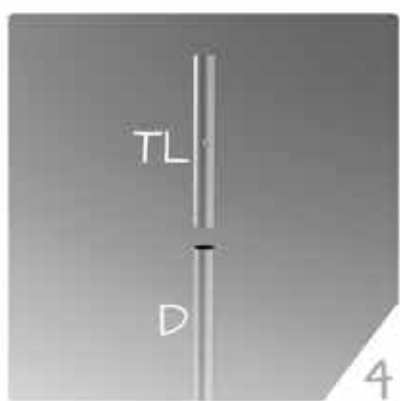
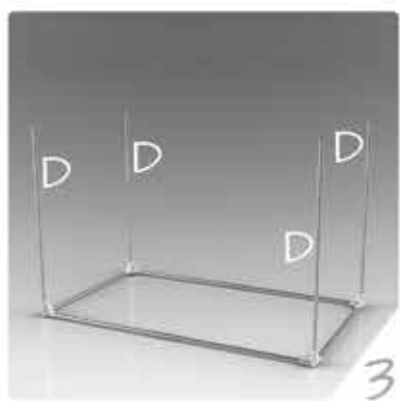
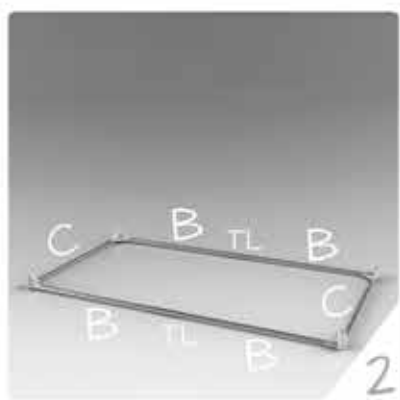
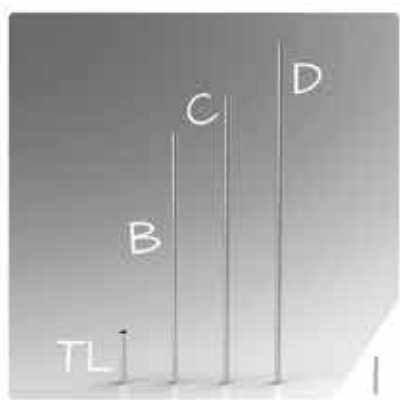





SECRET JARDIN

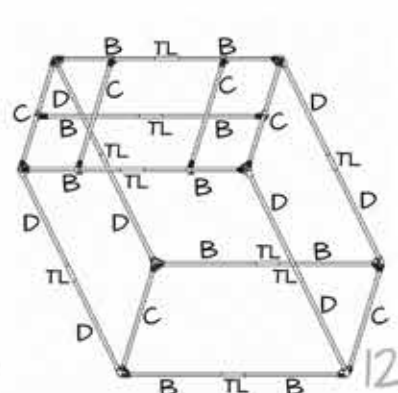

DARK ROOM

## DR240W

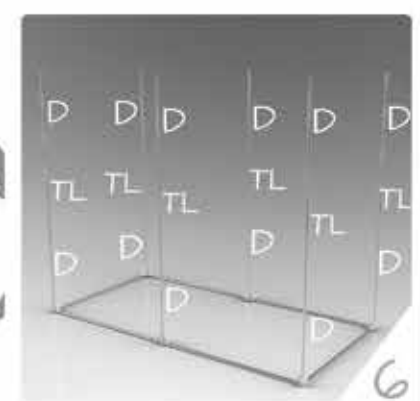
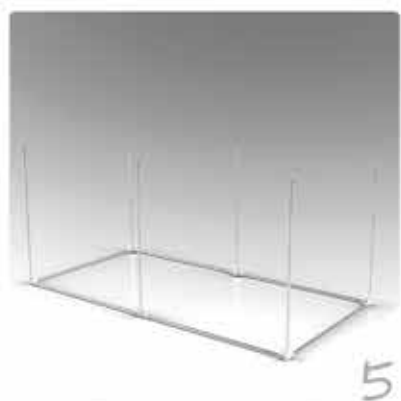
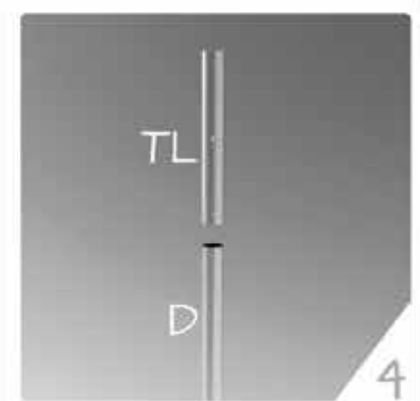
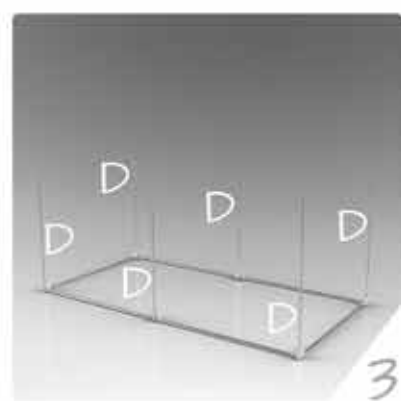
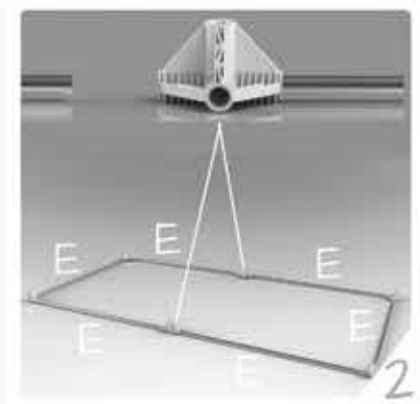
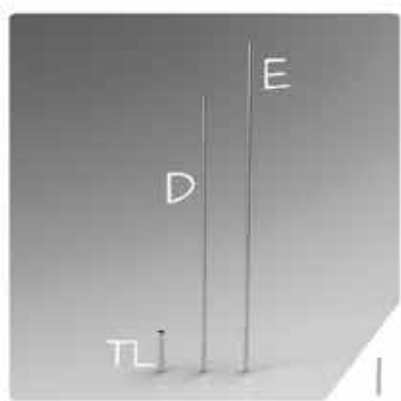



SECRET JARDIN

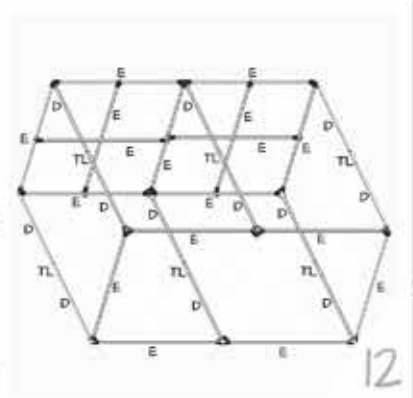

DARK ROOM

## DR300W

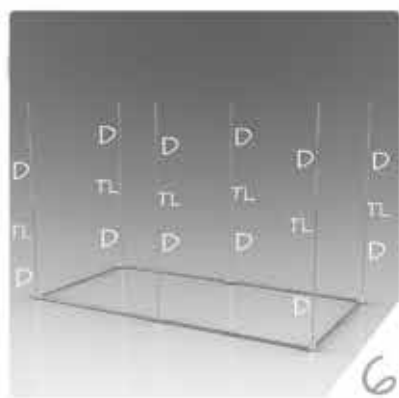
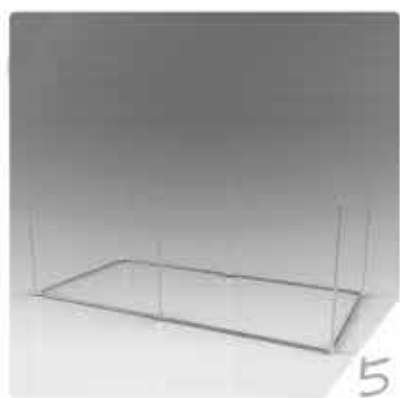
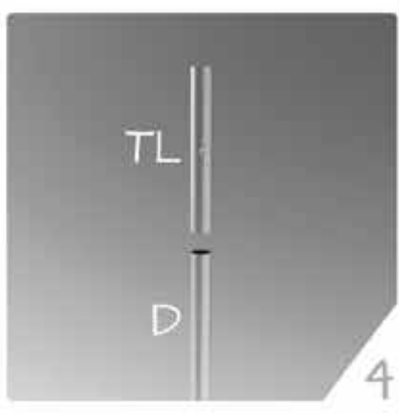
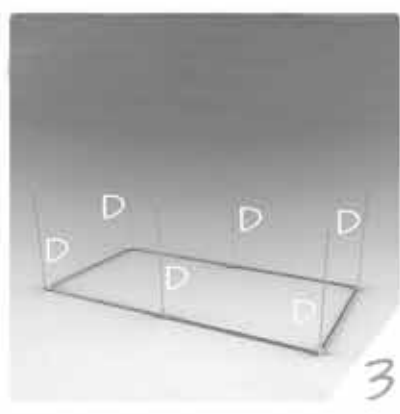
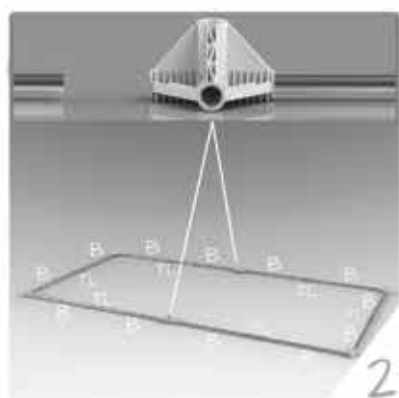
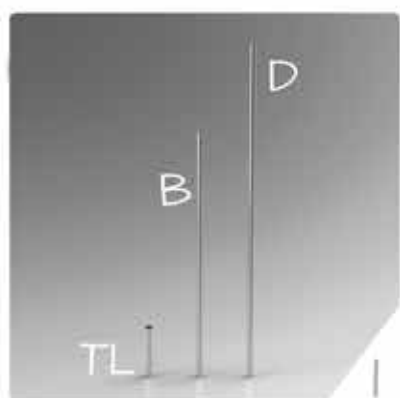



SECRET JARDIN

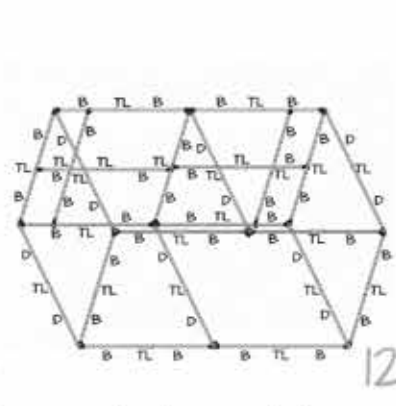

DARK ROOM

## DS60

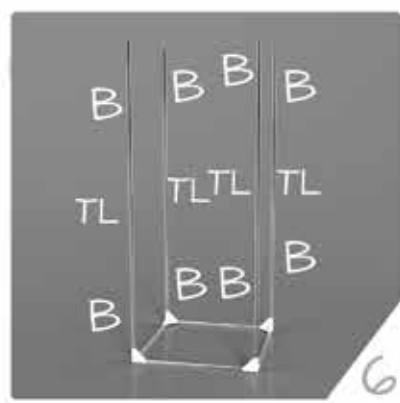
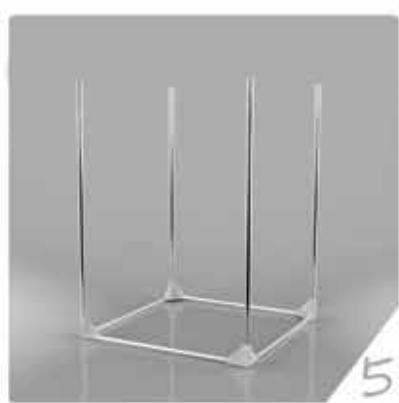
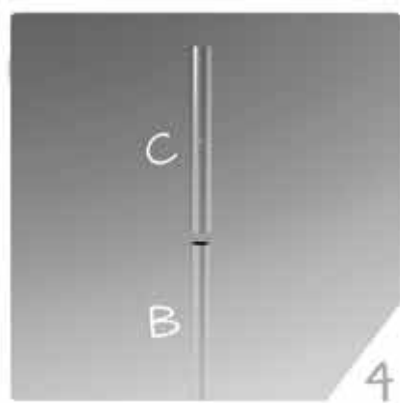
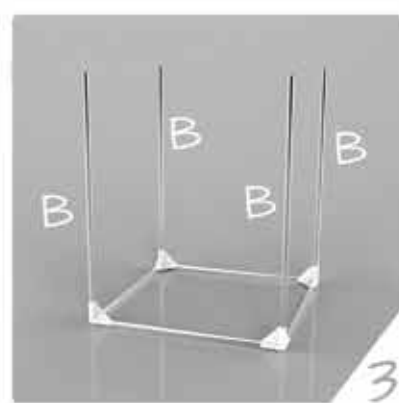
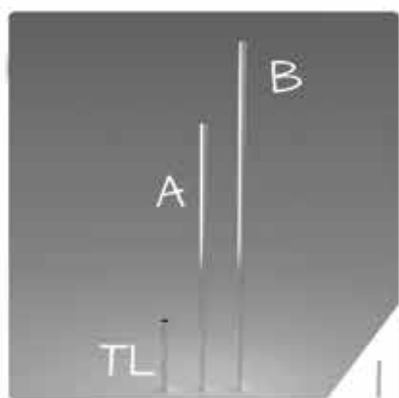



SECRET JARDIN



7



8



9



10



11

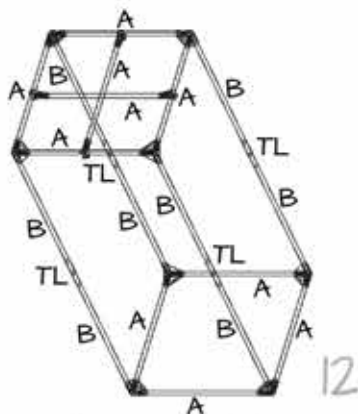

12

DARK STREET

## DS90

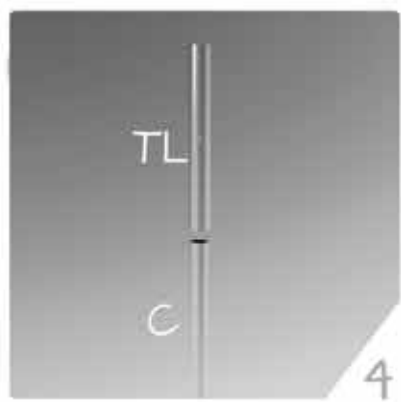
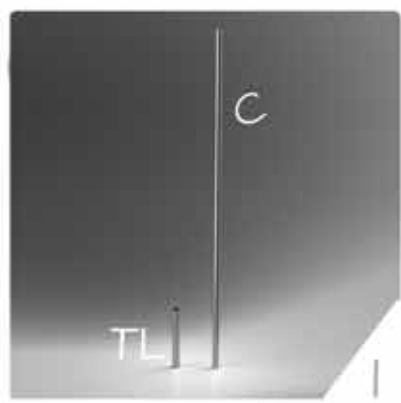





SECRET JARDIN



7



8



9



10



11

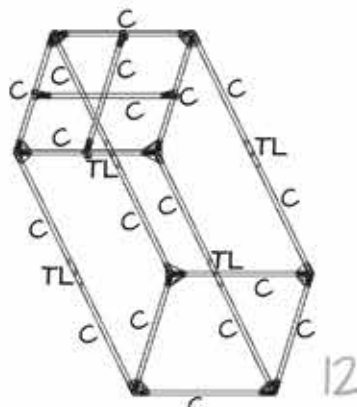

12

DARK STREET

## DS120

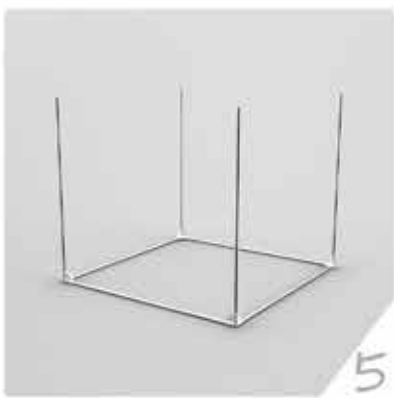
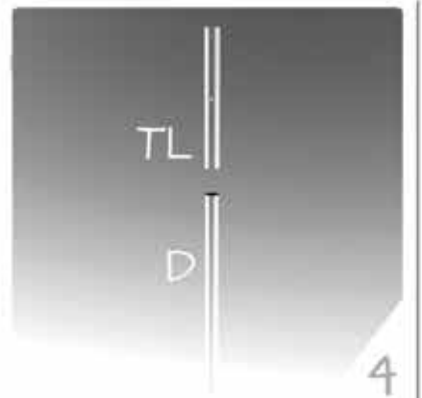
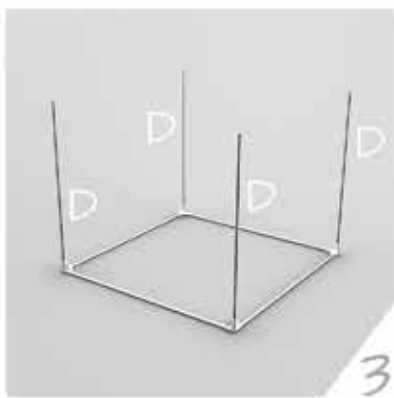
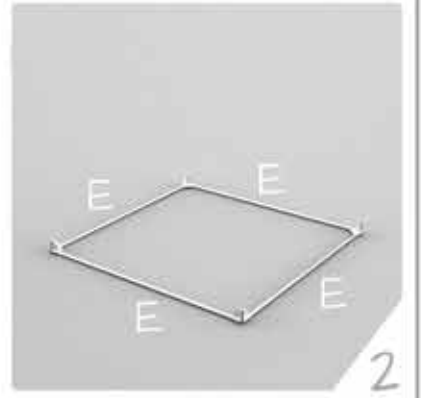
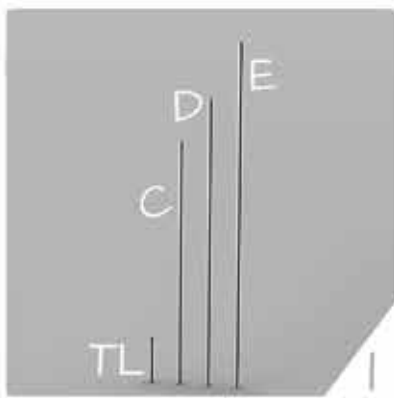



SECRET JARDIN

DARK STREET

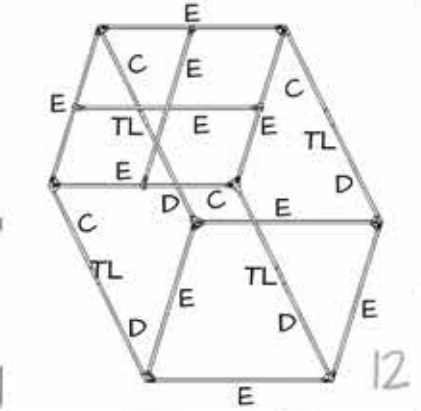
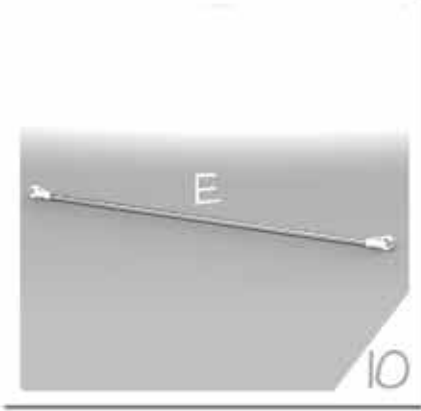
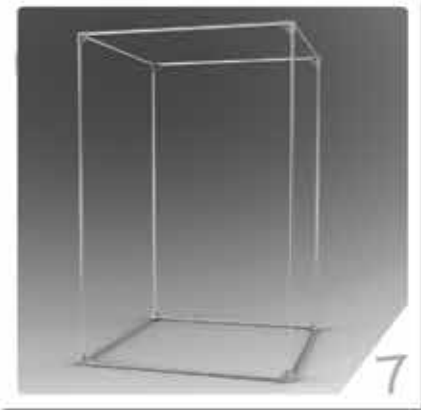

## DS150

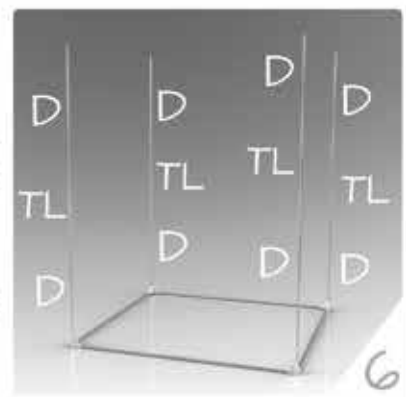
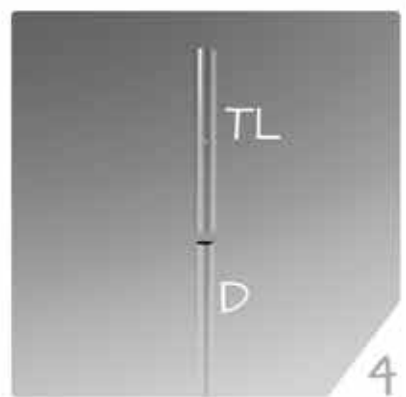
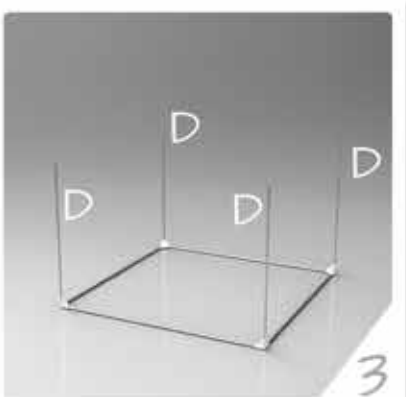
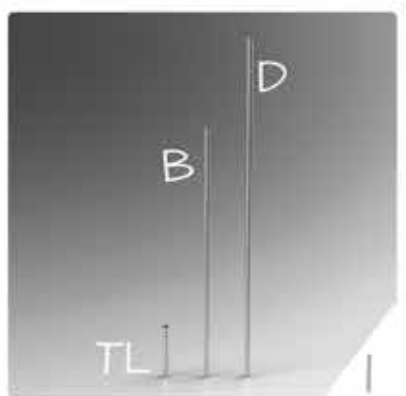



SECRET JARDIN

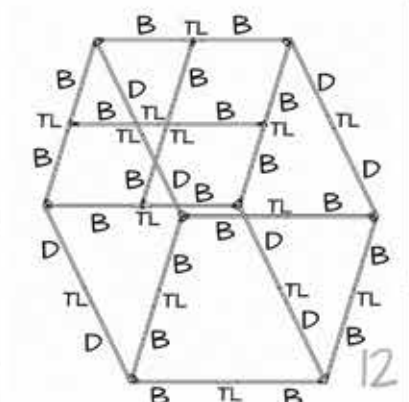
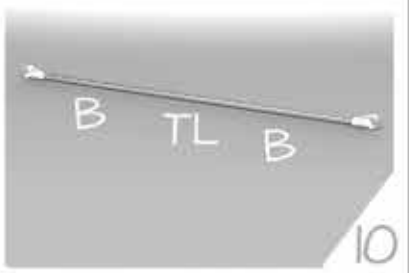
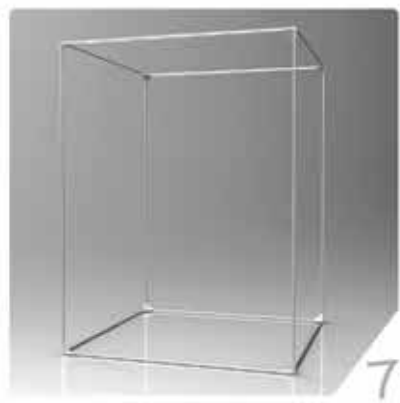

DARK STREET

## DS120W

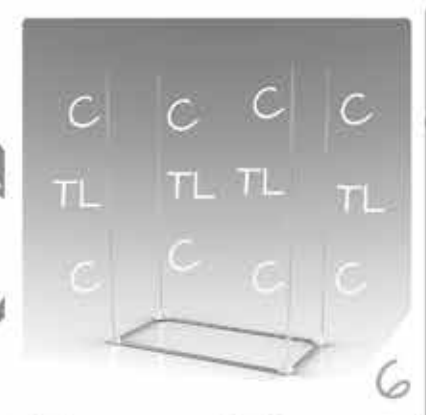



SECRET JARDIN



7



8

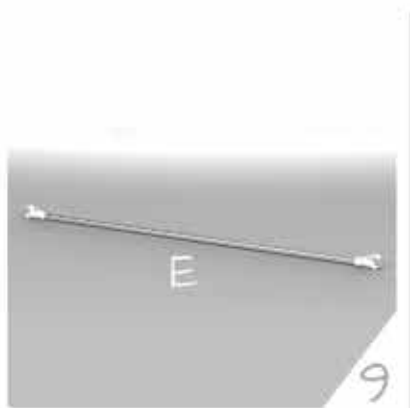

9



10



11

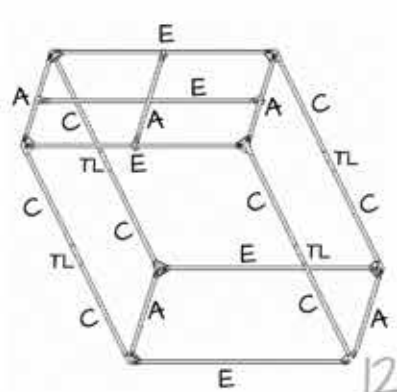

12

DARK STREET

## V100

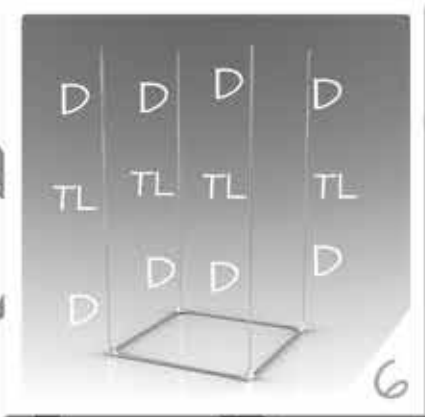
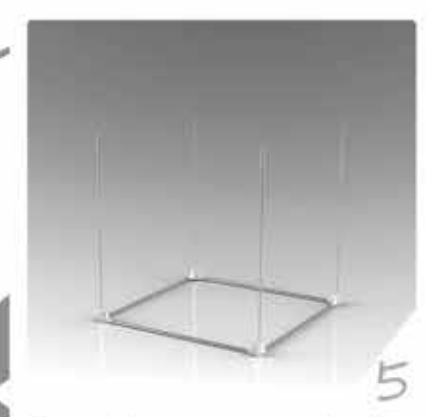
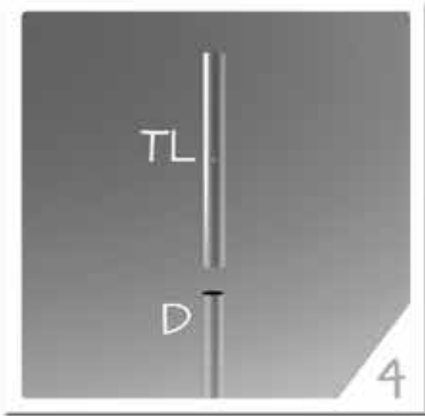
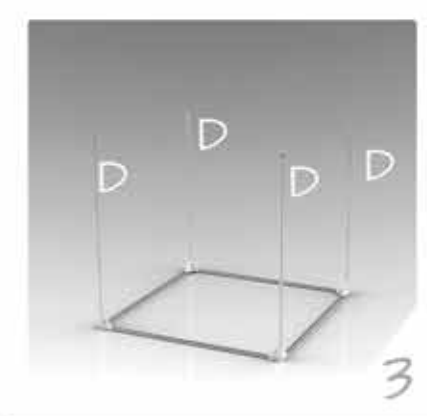





SECRET JARDIN

DARK STREET

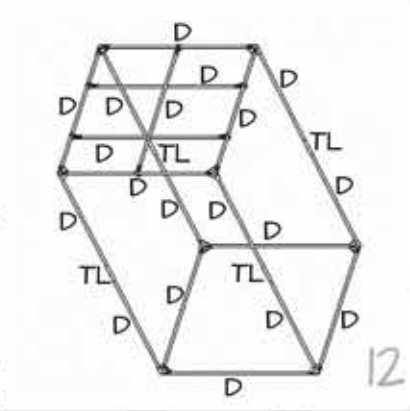

# T60

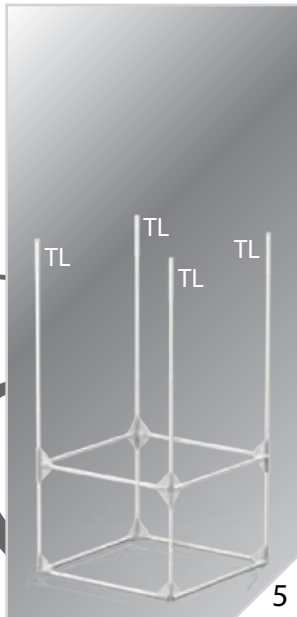
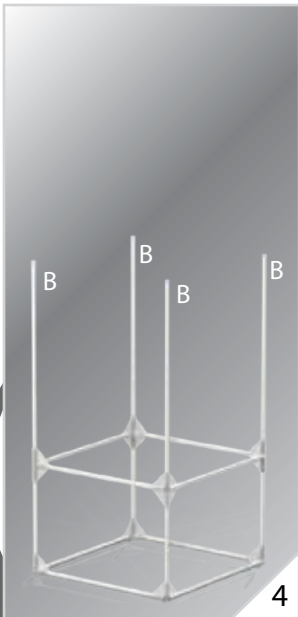
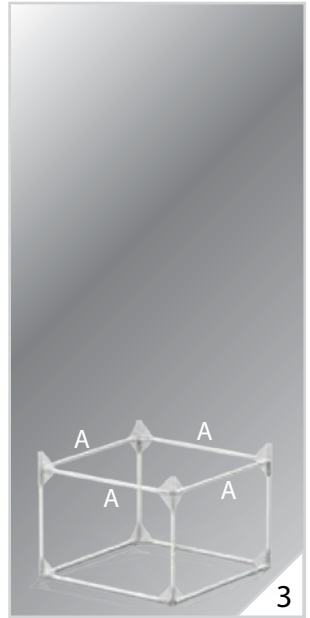
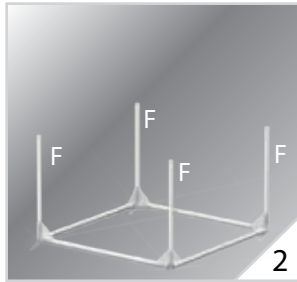
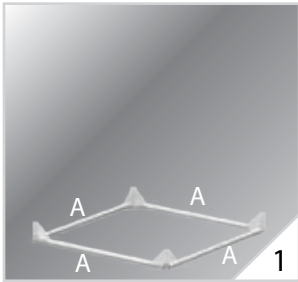
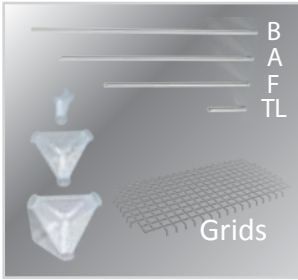



SECRET JARDIN

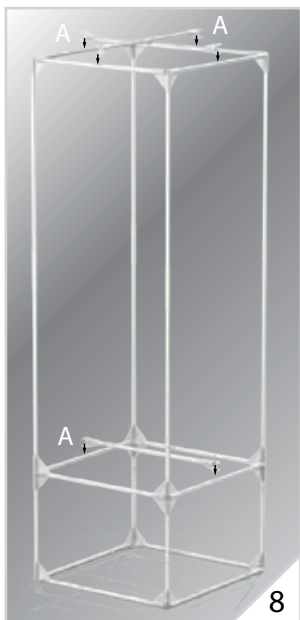

## T60



Display the structure on  
the bottom of the tent

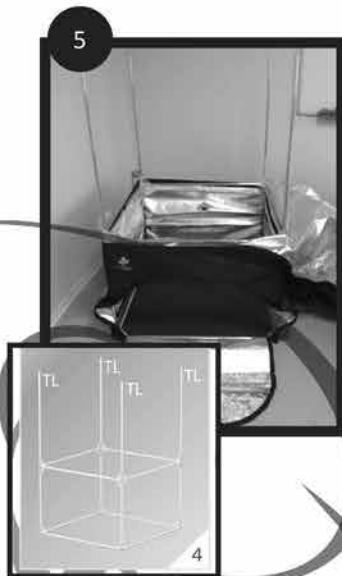
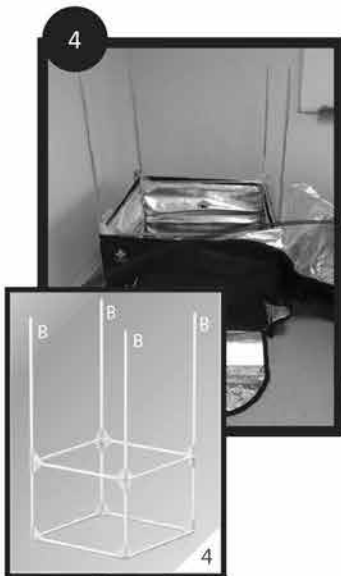

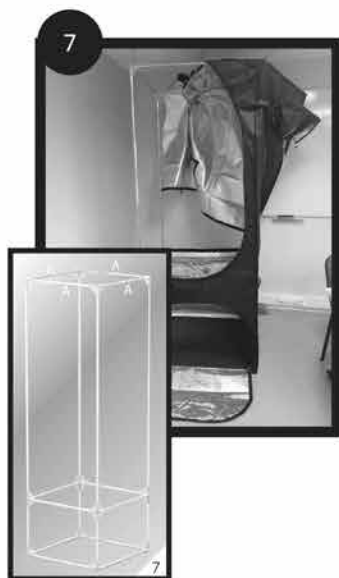

Display the mylar on top of the stucture

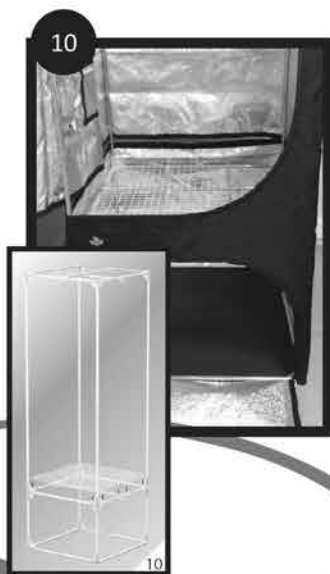

Display the separating cover on top of the grids



Display the Mylar Watertrays on both sections of the tent

# T90

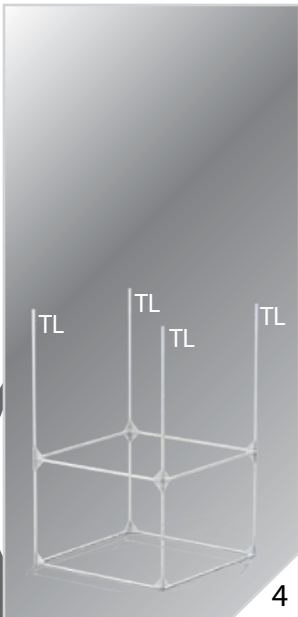
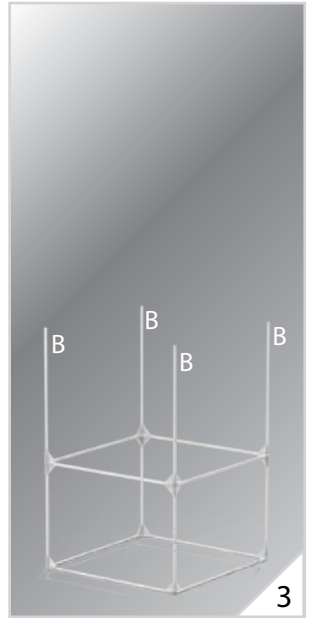
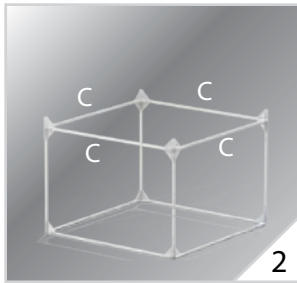
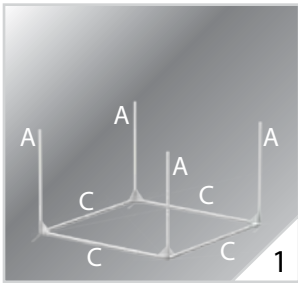
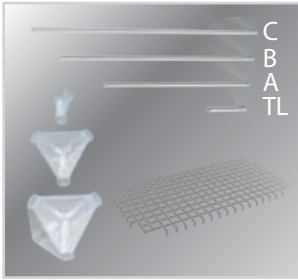



SECRET JARDIN



## T90



Display the structure on the bottom of the tent

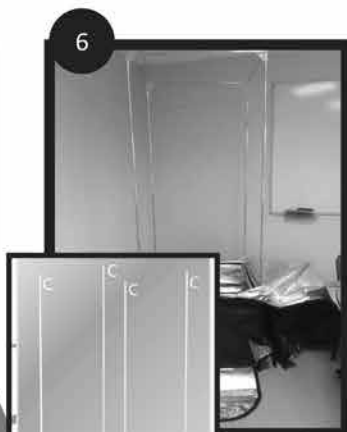
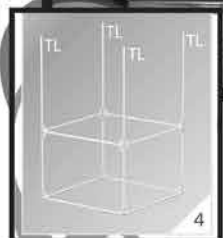
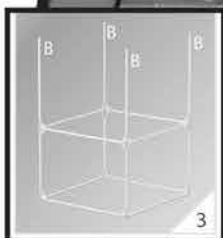
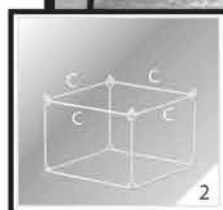
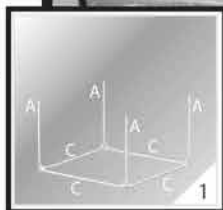



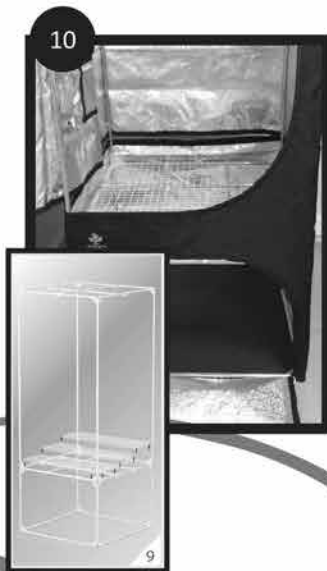

## DP90

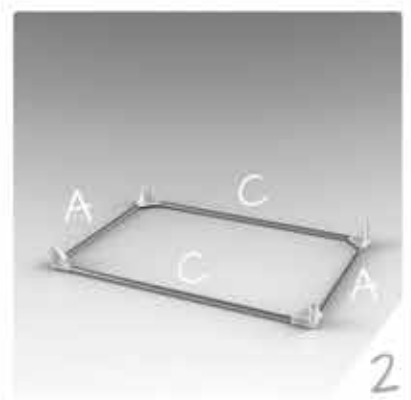
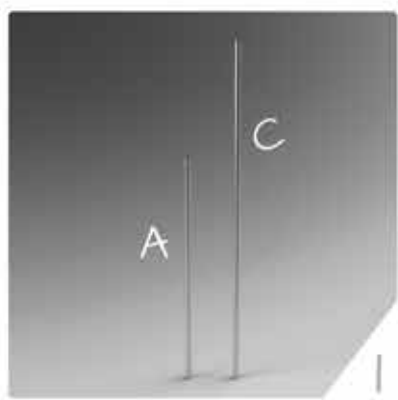



SECRET JARDIN

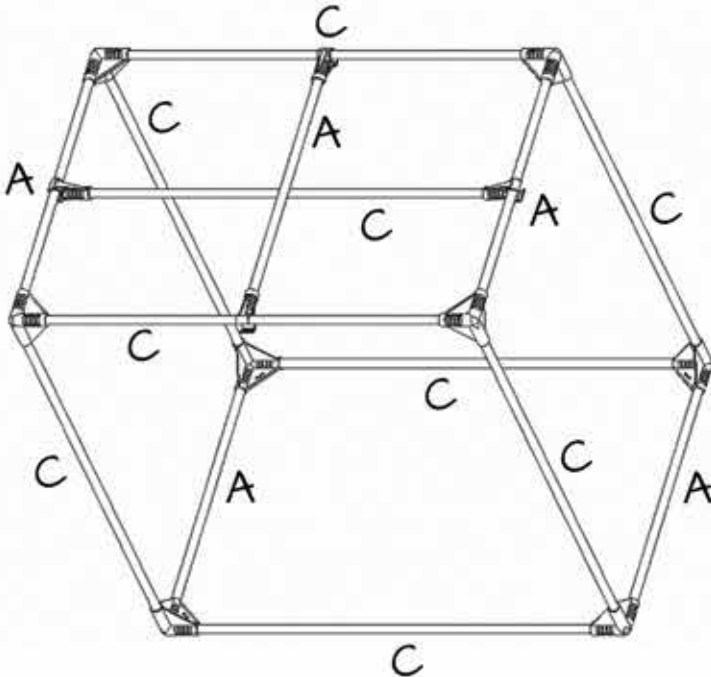
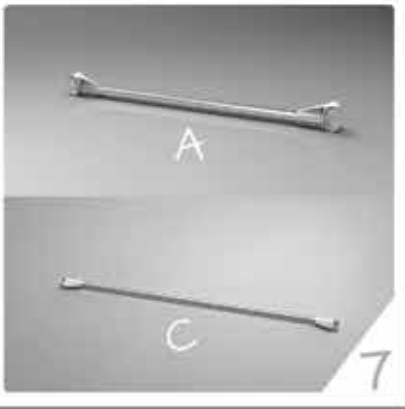

DARK PROPAGATOR

## DPI20

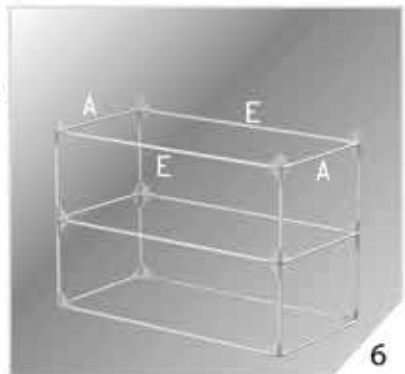
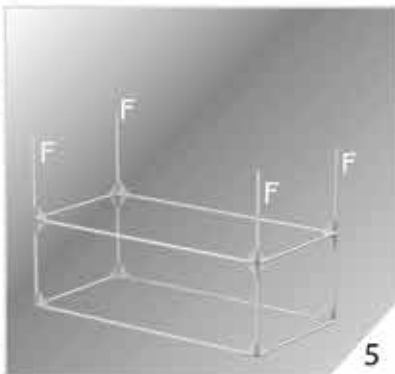
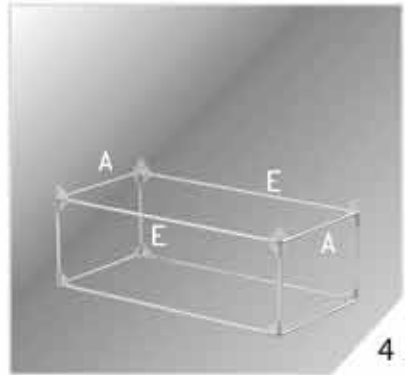
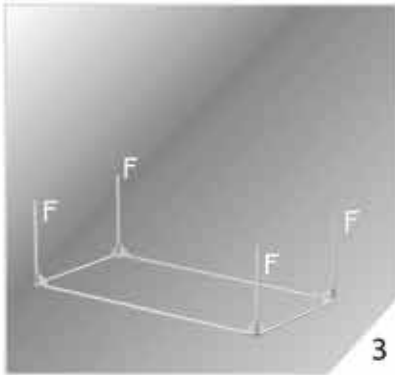
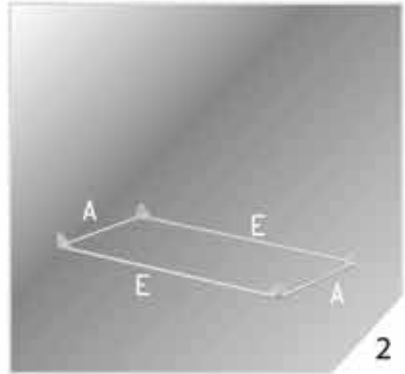
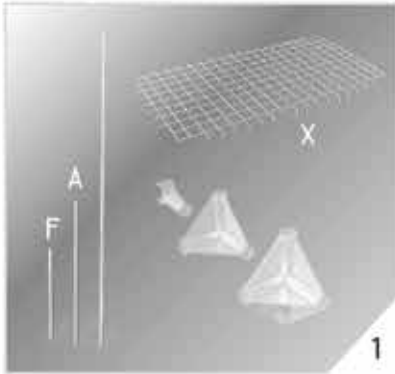



SECRET JARDIN

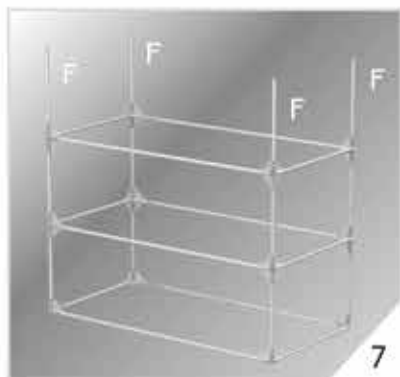

7

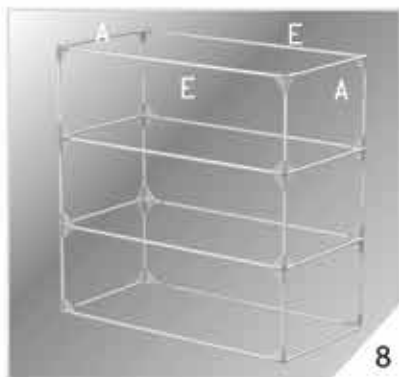

8

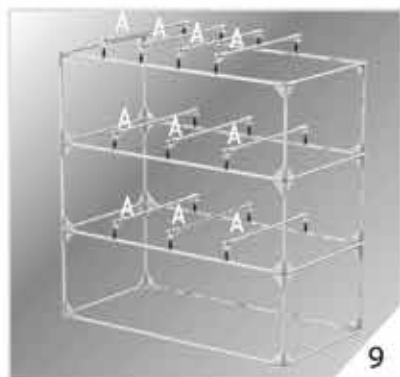

9



10



11



12

DARK PROPAGATOR

# CRISTAL

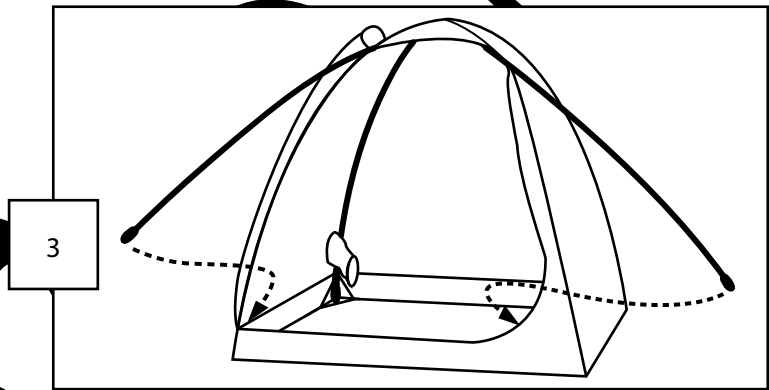
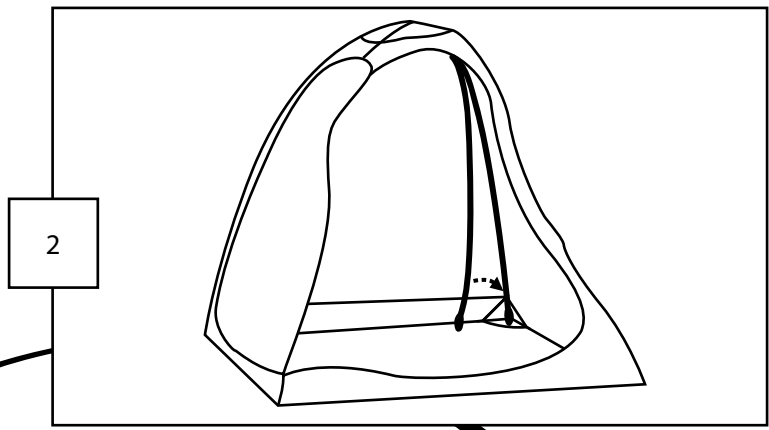
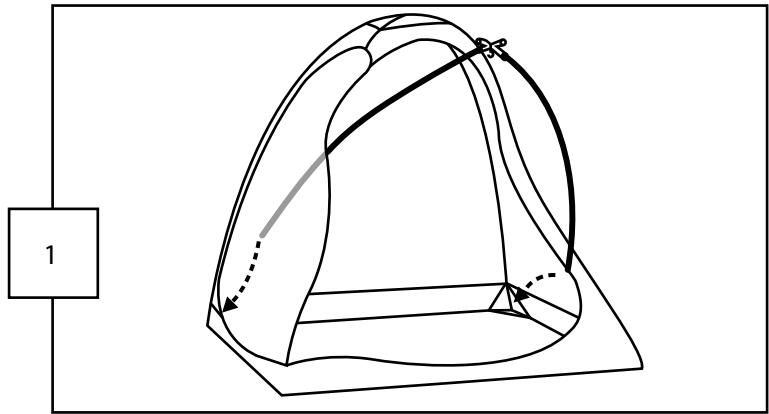

Assembly instructions for :

CR60



CR110



CR145



CRISTAL

# DD90

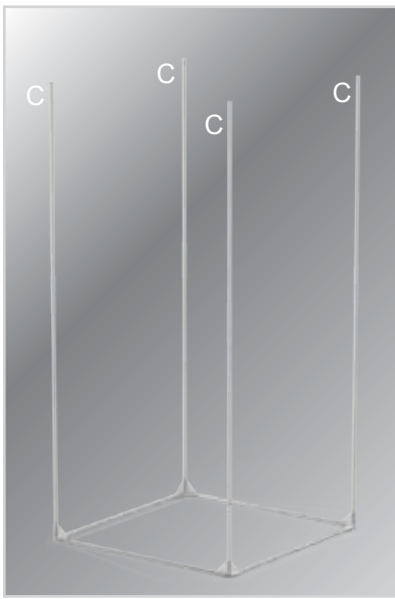
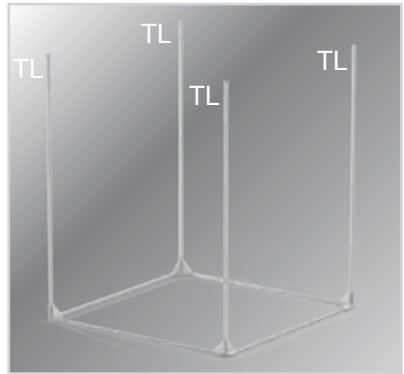
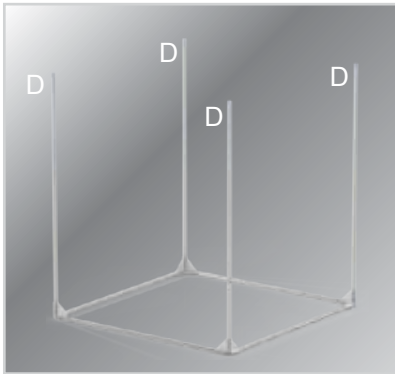
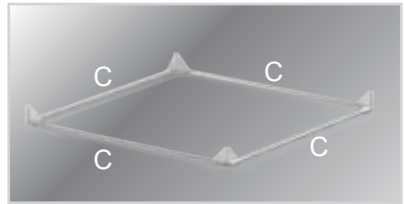
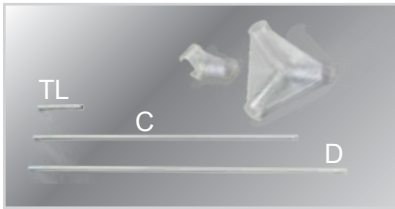





SECRET JARDIN DARKDRYER

# L90

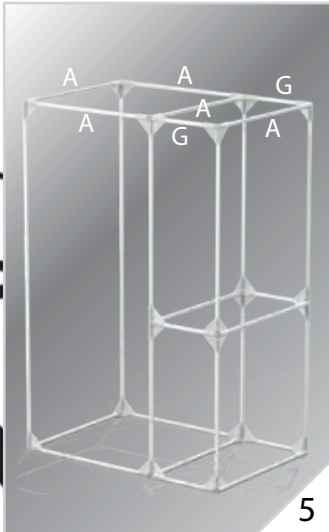
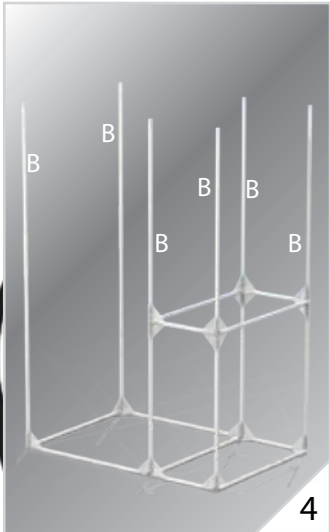
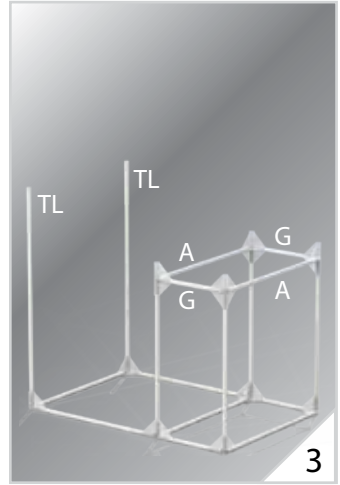
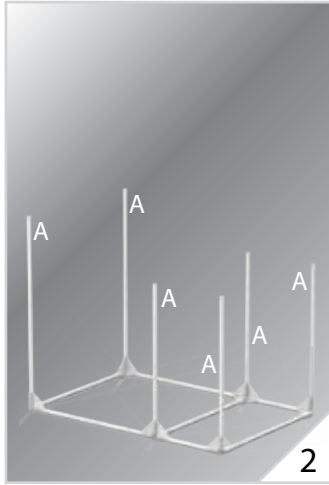
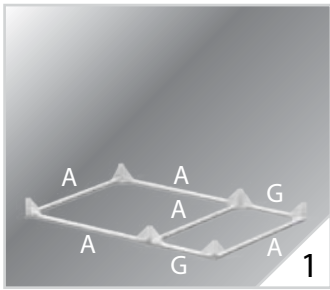
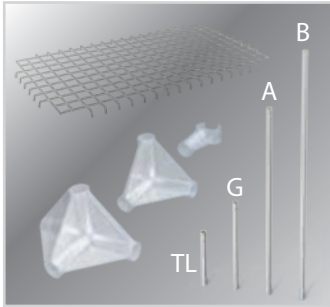



SECRET JARDIN



### Secret Jardin LODGE

Can be used with  
Secret Jardin Spare Parts  
(Grids, Trays, and  
Green House Covers)

# L120

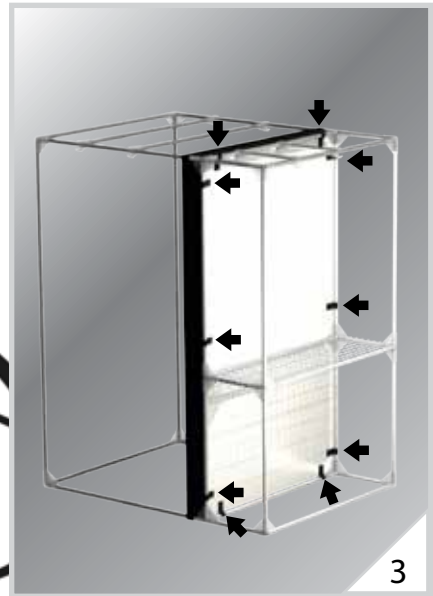
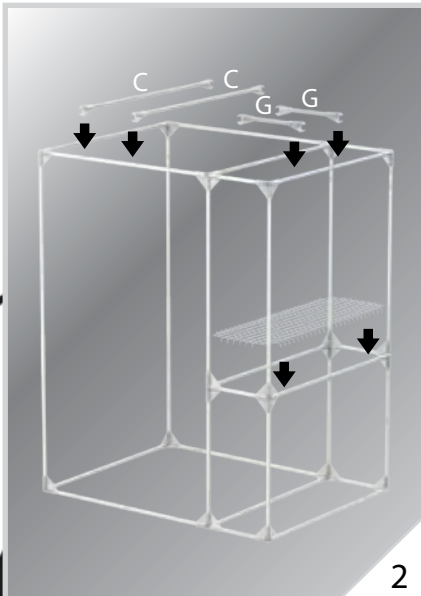
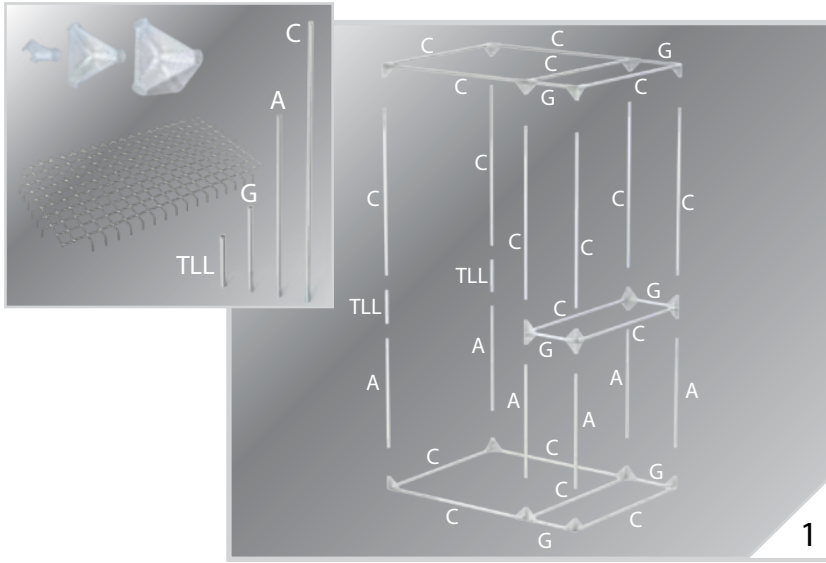

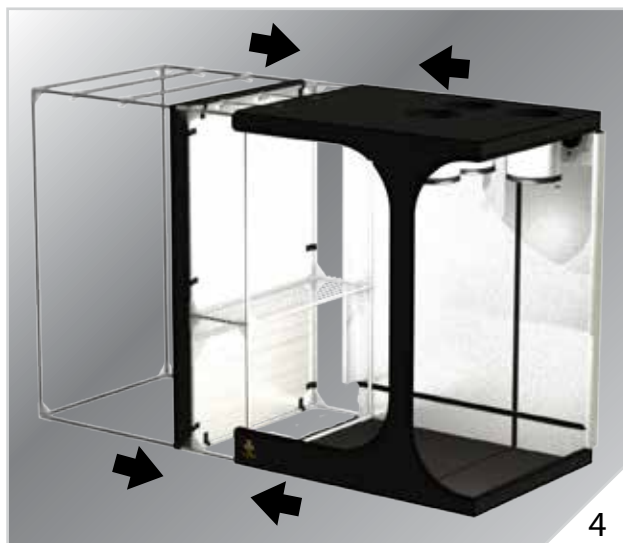

L'ODÉE

# L160

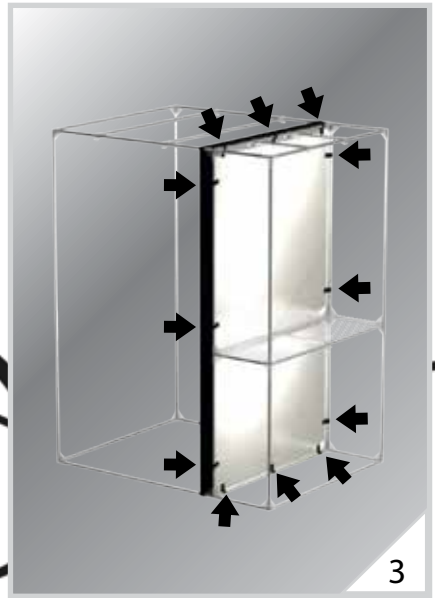
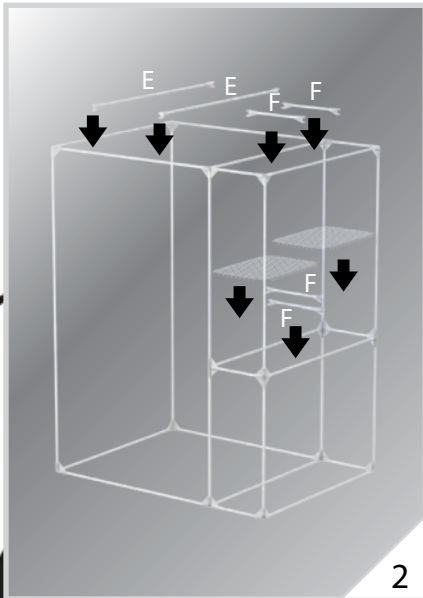
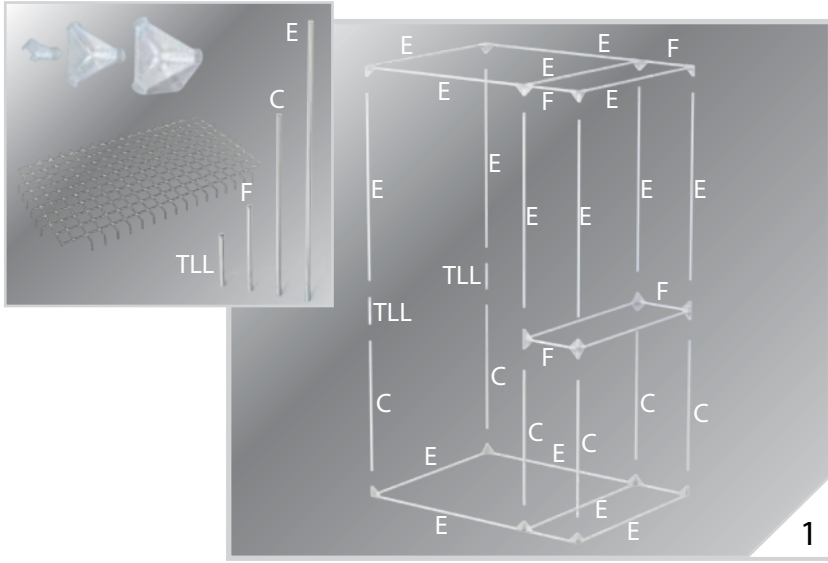

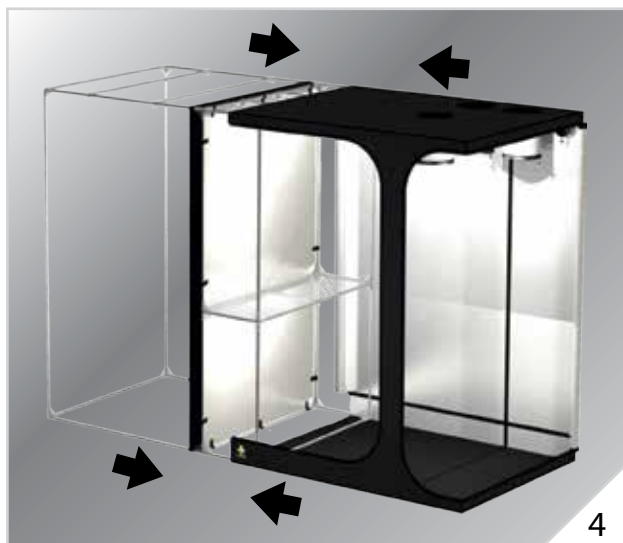

L'ODOR

## L280

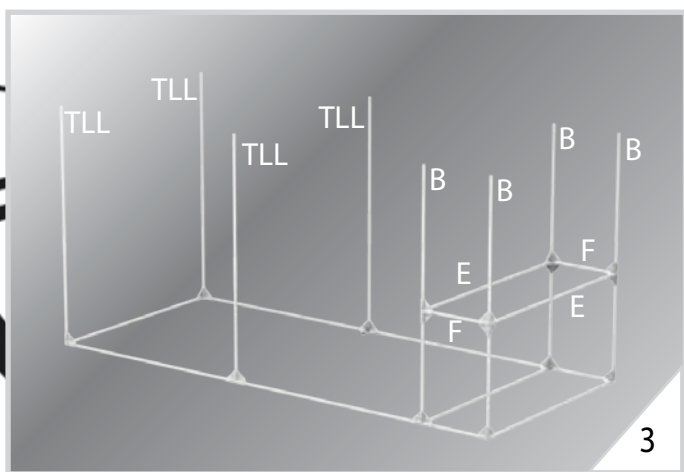
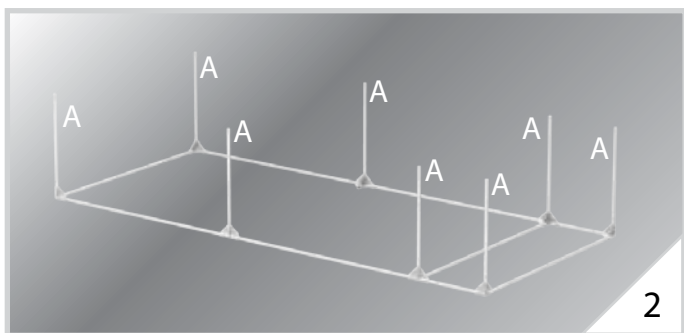
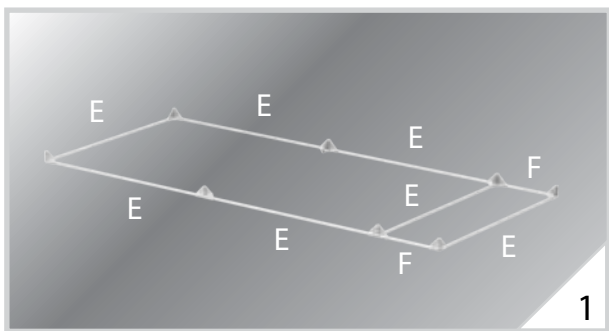
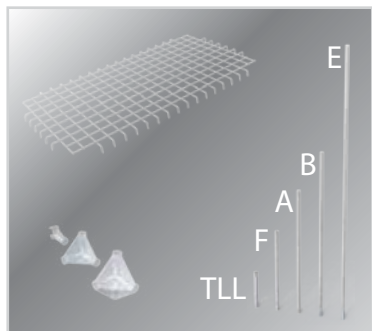



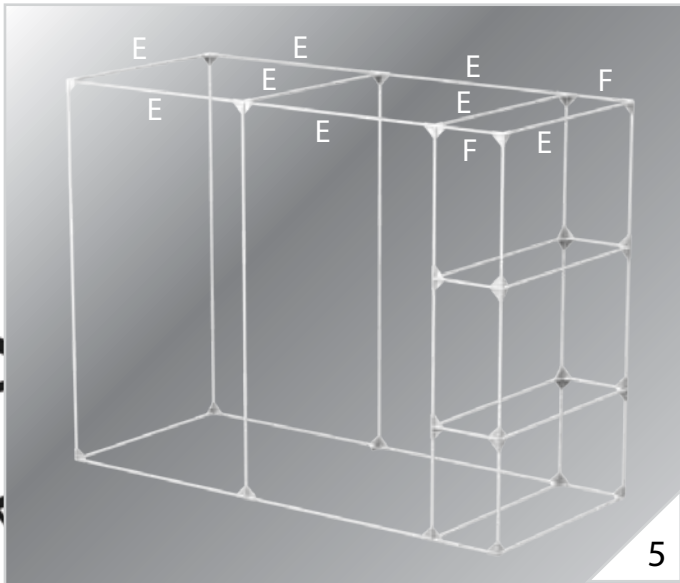
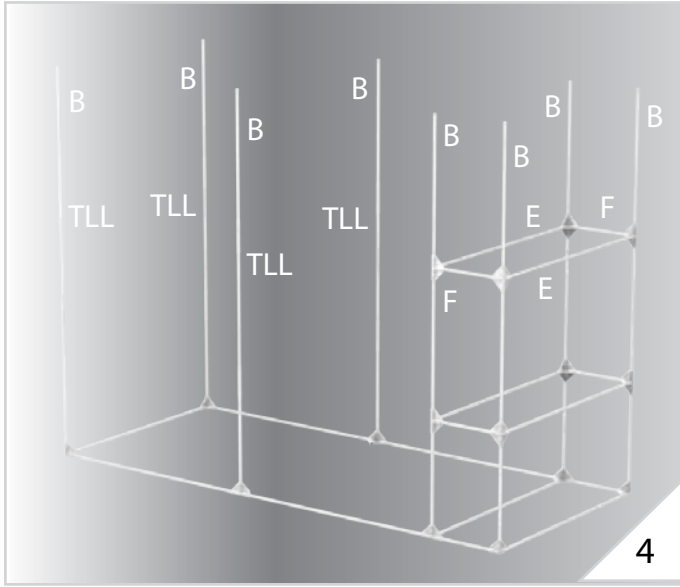

UODDE

# L280

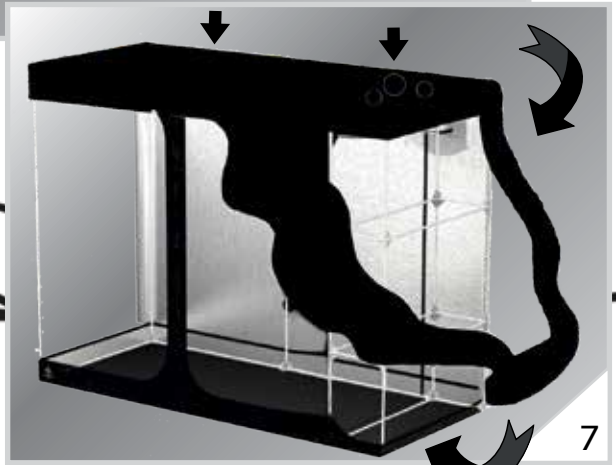
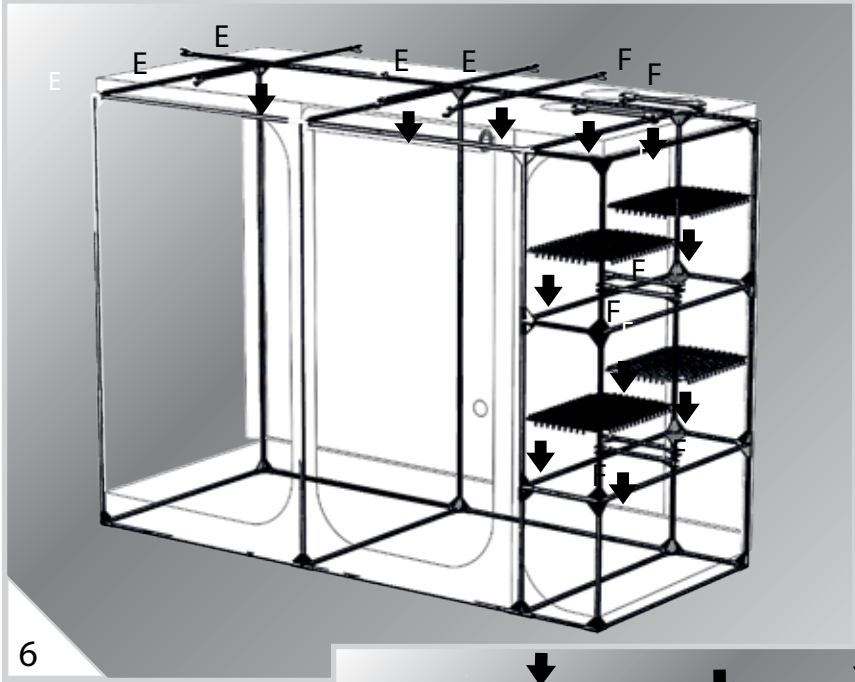



8



L'ART DE LA VIE

## ORI20

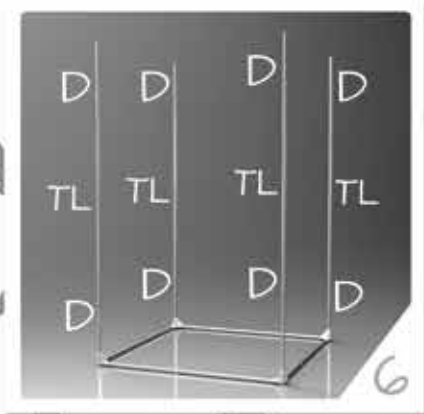
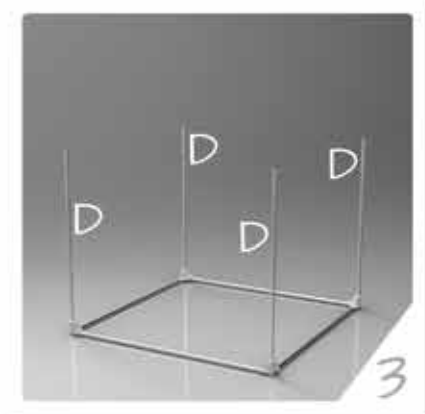
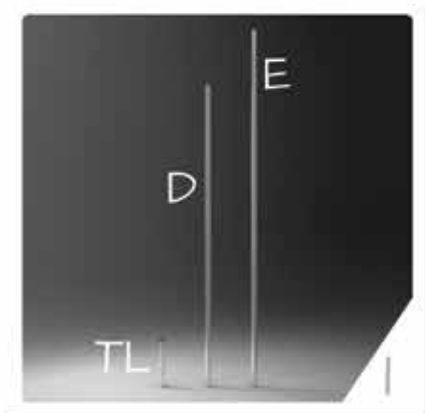

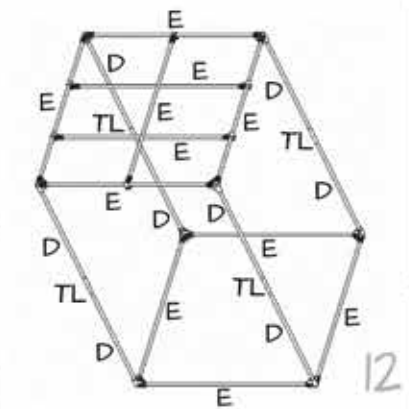
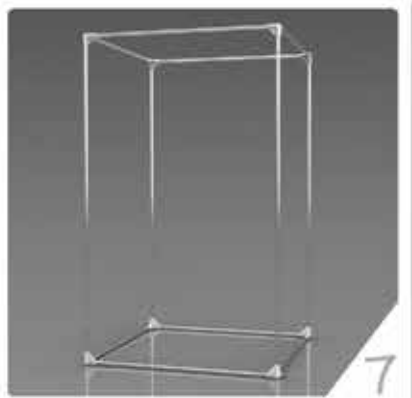

# ORCA CROW TENT - ORI20

## OR240W

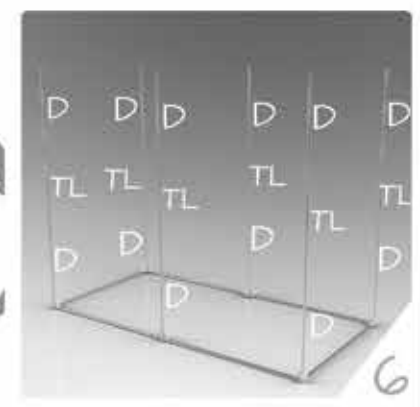
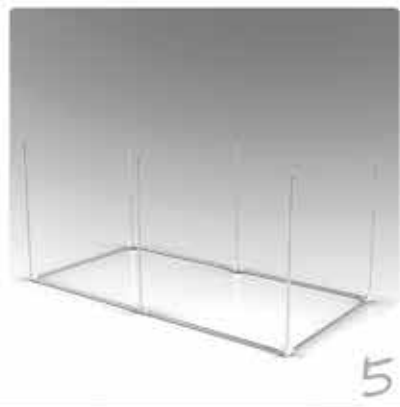
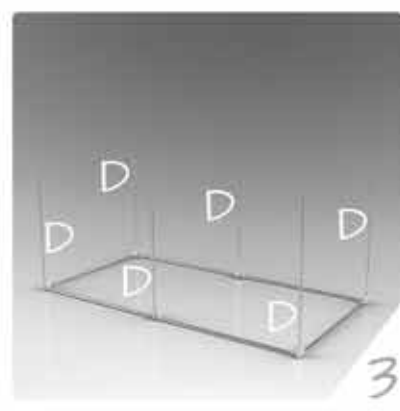
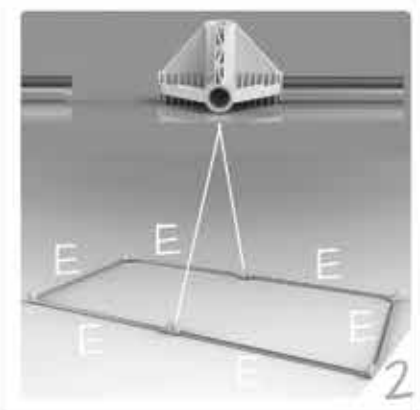
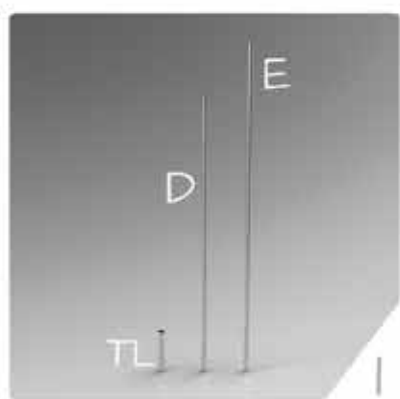

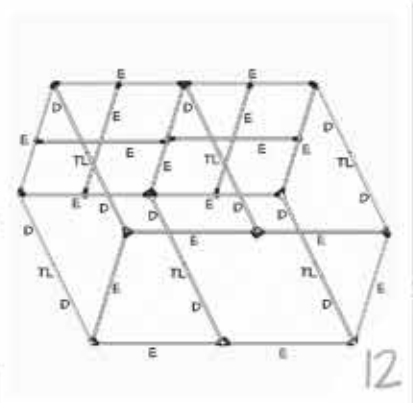

# Tent com

Spare Parts

Quantités par modèle

REF METRIC	DESIGNATION METRIC	DR60	DR90	DR120	DR150	DR240	DR300	DR150W	DR240W
C19-Y	Corner Ø19 mm 3 axes Y shape	8	8	8	8	8	8	8	8
C19-K	Corner Ø19 mm 4 axes K shape					8	8		4
C19-XL	Link Ø19 mm Straight joint XL					2	2		
C19-L	Link Ø19 mm Straight joint	4	4	4	15	8	36	9	6
C19-H	Corner Ø19 mm Handling	6	6	6	6	16	16	6	8
T19-A	Tube Ø19 mm 554 mm long A Type	11							
T19-B	Tube Ø19 mm 726 mm long B Type				22		56	10	
T19-C	Tube Ø19 mm 826 mm long C Type	8	15					6	
T19-D	Tube Ø19 mm 975 mm long D Type		4	8	8	16	16	8	12
T19-E	Tube Ø19 mm 1153 mm long E Type			11		28			17
C16-Y	Corner Ø16 mm 3 axes Y shape								
C16-K	Corner Ø16 mm 4 axes K shape								
C16- XL	Link Ø16 mm Straight joint XL								
C16-L	Link Ø16 mm Straight Joint								
C16-H	Corner Ø16 mm Handling								
T16-A	Tube Ø16 mm 563 mm long A Type								
T16-B	Tube Ø16 mm 730 mm long B Type								
T16-C	Tube Ø16 mm 835 mm long C Type								
T16-D	Tube Ø16 mm 980 mm long D Type								
T16-E	Tube Ø16 mm 1162 mm long E Type								
T16-F	Tube Ø16 mm 373 mm long F Type								
T16-G	Tube Ø16 mm 275 mm long G Type								
WT60	Water Tray 60x60 cm Mylar Made	1							
WT90	Water Tray 90x90 cm Mylar Made		1						
WT100	Water Tray 100x100 cm Mylar Made								
WT120	Water Tray 120x120 cm Mylar Made			1					
WT150	Water Tray 150x150 cm Mylar Made				1				
WT240	Water Tray 240x240 cm Mylar Made					1			
WT300	Water Tray 300x300 cm Mylar Made						1		
WT90.60	Water Tray 90x60 cm Mylar Made								
WT120.60	Water Tray 120x60 cm Mylar Made								
WT150.90	Water Tray 150x90 cm Mylar Made							1	
WT240.120	Water Tray 240x120 cm Mylar Made								1
WT300.150	Water Tray 300x150 cm Mylar Made								
HT30	Handling Tube 30cm long								
HT40	Handling Tube 40cm long								
HT60	Handling Tube 60cm long	3							
HT90	Handling Tube 90cm long		3					2	
HT100	Handling Tube 100cm long								
HT120	Handling Tube 120cm long			3					4
HT150	Handling Tube 150cm long				3		8	1	
G60	Metal Grid 30 x 60 cm								
G90	Metal Grid 30 x 90 cm								



# Composition

DR300W	V100	DS60	DS90	DS120	DS150	DS120W	DP90	DP120	T60	T90	L90	L120
8												
4												
23												
8												
34												
12												
	8	8	8	8	8	8	8	8	8	8	8	8
								8	4	4	8	8
											6	6
	4	4	4	4	14	4			4	4		
	6	4	4	4	4	4	4	20	6	12	8	8
		10				5	5	18	12	4	18	6
		8			20				8	4	6	
			18	4		8	9			16		18
	19			4	8							
				10		5		8				
								12	4			
											2	2
		1										
			1				1					
	1											
				1								
					1							
								1				
									1			
1												
											2	2
		2				1		10	3		2	
			2				1			6		2
	3											
				2		1						
2					2							
								8	2		1	
										3		1

# Advised tents

		<b>CUBIC GROW ROOM</b>		<b>FLOWERING</b>		<b>GROWING</b>				
		REF	DESIGNATION	High Pressure Sodium 2000°K		Metal Halid 4000°K				
				HPS Open	HPS Air Cooled					
INT	INT480	Intense 480x240x215 cm	8x HPS400	8x HPS600	8x MH400					
	INT600	Intense 600x300x215 cm	8x HPS600	8x HPS1000	8x MH600					
DR	DR60	Dark Room 60x60x170 cm	1x HPS150	1x HPS250	1x MH150					
	DR90	Dark Room 90x90x185 cm	1x HPS250	1x HPS400	1x MH250					
	DR120	Dark Room 120x120x200 cm	1x HPS400	1x HPS600	1x MH400					
	DR150	Dark Room 150x150x200 cm	1x HPS600	1x HPS1000	1x MH600					
	DR240	Dark Room 240x240x200 cm	4x HPS400	4x HPS600	4x MH400					
	DR300	Dark Room 300x300x200 cm	4x HPS600	4x HPS1000	4x MH600					
	DR150w	Dark Room Wide 150x90x200 cm	1x HPS400	1x HPS600	1x MH400					
	DR240w	Dark Room Wide 240x120x200 cm	2x HPS400	2x HPS600	2x MH400					
	DR300w	Dark Room Wide 300x150x200 cm	2x HPS600	2x HPS1000	2x MH600					
	DR480w	Dark Room Wide 480x240x200 cm	8x HPS400	8x HPS600	8x MH400					
DR600w	Dark Room Wide 600x300x200 cm	8x HPS600	8x HPS1000	8x MH600						
OR	OR120	Orca Tent 120x120x200 cm	1x HPS400	1x HPS600	1x MH400					
	OR240w	Orca Tent Wide 240x120x200 cm	2x HPS400	2x HPS600	2x MH400					
DS	V100	Vintage 103x103x200 cm	1x HPS400	1x HPS600	1x MH400					
	DS60	Dark Street 60x60x150 cm	1x HPS150W	1x HPS250W	1x MH150W					
	DS90	Dark Street 90x90x170 cm	1x HPS250W	1x HPS400W	1x MH250W					
	DS120	Dark Street 120x120x185 cm	1x HPS400W	1x HPS600W	1x MH400W					
	DS150	Dark Street 120x120x200 cm	1x HPS600W	1x HPS1000W	1x MH600W					
	DS120w	Dark Street Wide 120x60x170 cm	1x HPS250W	1x HPS400W	1x MH250W					
		<b>COMBINED STATIONS</b>		<b>FLOWERING</b>		<b>GROWING</b>				
		REF	DESIGNATION	High Pressure Sodium 2000°K		Metal Halid 4000°K				
				HPS Open	HPS Air Cooled					
T	T60	Twin 60x60x190 cm	1x HPS150W	1x HPS250W	1x MH150W					
	T90	Twin 90x90x220 cm	1x HPS250W	1x HPS400W	1x MH250W					
L	L90	Lodge 90x60x135 cm	1x HPS150W	1x HPS250W	1x MH150W					
	L120	Lodge 130x90x145 cm	1x HPS250W	1x HPS400W	1x MH250W					
	L160	Lodge 160x120x205 cm	1x HPS400W	1x HPS600W	1x MH400W					
	L280	Lodge 280x120x210 cm	2x HPS400W	2x HPS600W	2x MH400W					
		<b>OTHER TENTS</b>		<b>FLOWERING</b>		<b>GROWING</b>				
		REF	DESIGNATION	Fluo Compact 2100°K		Fluo Compact 6500°K				
CR	CR60	Cristal Room 60x60x55 cm	CFL40W		CFL300W		CFL300W			
	CR110	Cristal Room 110x110x105 cm	CFL300W		-		CFL300W			
	CR145	Cristal Room 145x145x140 cm	-		-		CFL300W			
DP	DP90	Dark Propagator 90x60x90 cm	2x TN110		-		1x TN110			
	DP120	Dark Propagator 120x60x200 cm	8x TN110		-		4x TN110			
DD	DD90	Dark Dryer 90x90x185 cm	-		-		-			

# configuration

					
GROWING	PROPAGATION	VOL	EXTRACTION REQUIRED		
Fluo Compact 6500°K	Fluo Compact 9500°K	m3	Every 30s HPS Open	Every 1 mn HPS Air Cooled	Every 2 mn & Outside <20°C
24x TN110 36x TN110	12x TN110 18x TN110	24,8 38,7	2970 m3/h 4640 m3/h	1490 m3/h 2320 m3/h	740 m3/h 1160 m3/h
1x TN110 2x TN110 3x TN110 4x TN110 12x TN110 18x TN110	1x TN55 1x TN110 2x TN110 2x TN110 6x TN110 9x TN110	0,6 1,5 2,9 4,5 11,5 18,0	75 m3/h 180 m3/h 345 m3/h 540 m3/h 1380 m3/h 2160 m3/h	35 m3/h 90 m3/h 175 m3/h 270 m3/h 690 m3/h 1080 m3/h	20 m3/h 45 m3/h 85 m3/h 135 m3/h 350 m3/h 540 m3/h
3x TN110 6x TN110 8x TN110 24x TN110 36x TN110	2x TN110 4x TN110 4x TN110 12x TN110 18x TN110	2,7 5,8 9,0 23,0 36,0	325 m3/h 690 m3/h 1080 m3/h 2760 m3/h 4320 m3/h	160 m3/h 345 m3/h 540 m3/h 1380 m3/h 2160 m3/h	80 m3/h 175 m3/h 270 m3/h 690 m3/h 1080 m3/h
3x TN110 6x TN110	2x TN110 4x TN110	2,9 5,8	345 m3/h 690 m3/h	175 m3/h 345 m3/h	85 m3/h 175 m3/h
3x TN110	1x TN110	2,1	255 m3/h	125 m3/h	65 m3/h
1x TN110 2x TN110 3x TN110 4x TN110 2x TN110	1x TN55 1x TN110 2x TN110 2x TN110 2x TN55	0,5 1,4 2,7 4,5 1,2	65 m3/h 165 m3/h 320 m3/h 540 m3/h 145 m3/h	30 m3/h 85 m3/h 160 m3/h 270 m3/h 75 m3/h	15 m3/h 40 m3/h 80 m3/h 135 m3/h 35 m3/h
GROWING	PROPAGATION	VOL	EXTRACTION REQUIRED MAIN ROOM		
Fluo Compact 6500°K	Fluo Compact 9500°K	m3	Every 30s HPS Open	Every 1 mn HPS Air Cooled	Every 2 mn & Outside <20°C
1x TN110 2x TN110	1x TN55 1x TN110	0,5 1,3	65 m3/h 155 m3/h	30 m3/h 80 m3/h	15 m3/h 40 m3/h
1x TN55 2x TN55 2x TN55 4x TN55	1x TN55 1x TN55 2x TN55 4x TN55	0,5 1,2 3,0 6,0	60 m3/h 140 m3/h 355 m3/h 725 m3/h	30 m3/h 70 m3/h 175 m3/h 365 m3/h	15 m3/h 35 m3/h 90 m3/h 180 m3/h
GROWING	PROPAGATION	VOL	EXTRACTION REQUIRED		
Compact 60°K	Fluo Compact 9500°K	m3	Every 30s	Every 1 mn CFL	Every 2 mn & Outside <20°C
40W 125W 300W	CFL40W CFL125W CFL125W	0,1 0,7 1,7	Natural (Permissive Material Bottom - Top)		
			90 m3/h 205 m3/h	45 m3/h 105 m3/h	20 m3/h 50 m3/h
TN110 TN110	1x TN55 4x TN55	0,5 0,9	60 m3/h 105 m3/h	30 m3/h 50 m3/h	15 m3/h 25 m3/h
-	-	1,5	180 m3/h	90 m3/h	45 m3/h

Secret Jardin (PENVC)  
190 rue du Cerf . 1332 Genval  
Belgium  
Phone: +32 265 25081  
Fax: +32 265 259 79  
[support@secretjardin.com](mailto:support@secretjardin.com)



secret jardin