

IMPORTANT

Product defect? Not working properly?

DO NOT return this product to the store where you purchased it.

Contact Ideal Air Support directly at support@ideal-air.com or call

1-877-9-IDEAL-1

For answers to the most common questions and a complete technical support library please visit www.ideal-air.com

For warranty claims contact the Customer Care Center

1-866-646-4332

IDEALair™

5408 NE 88th St., Bldg. A
Vancouver, WA 98665

www.ideal-air.com

A division of Sunlight Supply

All design and specifications herein are subject to change without notice for product improvement. Contact Ideal Air for details, updates and other information.

OWNER'S MANUAL

IDEALair™
Dehumidifiers

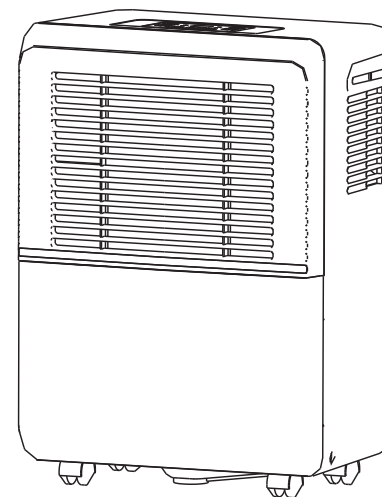

IMPORTANT!

Before operating this product, please read the instructions carefully and save this manual for future use.

PLEASE BE RESPONSIBLE

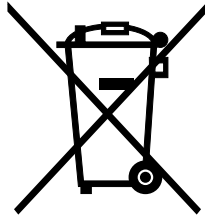

DO NOT dispose of this product in the trash, on the landscape or into any unsorted waste stream!

It may contain hazardous substances that can leach into groundwater and find their way into the food chain.

This unit contains VALUABLE RESOURCES that are easy to turn in for recycling and re-use. Services available may include:

- A. Municipal Collection Systems:** Most cities and towns have established programs where electronic waste can be turned in for recycling free of charge.
- B. Retailer Return:** When buying a new product, many retailers will take back an old product free of charge.
- C. Manufacturer Return:** Many manufacturers accept old products for recycling free of charge.
- D. Scrap Dealers:** Many scrap dealers will buy old electronics or take them free of charge.

SAFETY INFORMATION

Warning2
Caution2
Electrical Information3

CONTROL PANEL

Control Panel Keys and Functions4
Other Features5

PARTS, PLACEMENT & OPERATION

Parts Identification6
Placement and Operation.....7

REMOVING COLLECTED WATER

When Bucket is Full.....8
Continuous Drain.....8

CARE & MAINTENANCE

Cleaning and Storing9



TROUBLESHOOTING TIPS 10

WARRANTYInside Back Cover

Safety Precautions

To prevent injury to the user or other people and property damage, the following instructions must be followed. Incorrect operation due to ignoring of instructions may cause harm or damage.













■ The seriousness is classified by the following indications.

 WARNING	This symbol indicates the possibility of death or serious injury.
 CAUTION	This symbol indicates the possibility of injury or damage to property.



■ Meanings of symbols used in this manual are as shown below.

	Never do this.
	Always do this.

WARNING









-  Do not exceed the rating of the power outlet or connection device.
 - Otherwise, it may cause electric shock or fire due to excess heat generation.
-  Do not operate or stop the unit by switching on or off the power.
 - It may cause electric shock or fire due to heat generation.
-  Do not damage or use an unspecified power cord.
 - It may cause electric shock or fire.
-  Do not modify power cord length or share the outlet with other appliances.
 - It may cause electric shock or fire due to heat generation.
-  Do not insert or pull out plug with wet hands.
 - It may cause electric shock.
-  Do not place the unit near a heat source.
 - Plastic parts may melt and cause a fire.
-  Disconnect the power if strange sounds, smells, or smoke comes from the unit.
 - It may cause fire and electric shock.
-  You should never try to take apart or repair the unit by yourself.
 - It may cause failure of machine or electric shock.
-  Before cleaning, turn off the power and unplug the unit.
 - It may cause electrical shock or injury.
-  Do not use the machine near flammable gas or combustibles, such as gasoline, benzene, thinner, etc.
 - It may cause an explosion or fire.
-  Do not drink or use the water drained from the unit.
 - It contains contaminants and could make you sick.
-  Do not take the water tank out during operation.
 - It may cause a "tank full" protect of the unit and cause electric shock.

CAUTION

-  Do not use the unit in small spaces.
 - Lack of ventilation can cause overheating and fire.
-  Do not put in places where water may splash onto the unit.
 - Water may enter the unit and degrade the insulation. It may cause an electric shock or fire.
-  Place the unit on a level, sturdy section of the floor.
 - If the unit falls over, it may cause water to spill and damage belongings, or cause electrical shock or fire.

Safety Precautions

CAUTION

-  Do not cover the intake or exhaust openings with cloths or towels.
 - A lack of air flow can lead to overheating and fire.
-  Care should be taken when using the unit in a room with the following persons:
 - Infants, children, elderly people, and people not sensitive to humidity.
-  Do not use in areas where chemicals are handled.
 - This will cause the unit deterioration due to chemicals and solvents dissolved in the air.
-  Never insert your finger or other foreign objects into grilles or openings. Take special care to warn children of these dangers.
 - It may cause electric shock or failure of appliance.
-  Do not place heavy objects on the power cord and take care so that the cord is not compressed.
 - There is danger of fire or electric shock.
-  Do not climb up on or sit on the unit.
 - You may be injured if you fall or if the unit falls over.
-  Always insert the filters securely. Clean filter once every two weeks.
 - Operation without filters may cause failure.
-  If water enters the unit, turn the unit off and disconnect the power, contact a qualified service technician.
 - It may cause failure of appliance or accident.
-  Do not place flower vases or other water container on top of the unit.
 - Water may spill inside the unit, causing insulation failure and electrical shock or fire.



ELECTRICAL INFORMATION

- The manufacturer's nameplate is located on the rear panel of the unit and contains electrical and other technical data specific to this unit.
- Be sure the unit is properly grounded. To minimize shock and fire hazards, proper grounding is important. The power cord is equipped with a three-prong grounding plug for protection against shock hazards.
- Your unit must be used in a properly grounded wall receptacle. If the wall receptacle you intend to use is not adequately grounded or protected by a time delay fuse or circuit breaker, have a qualified electrician install the proper receptacle.
- Ensure the receptacle is accessible after the unit installation.
- Do not use extension cords or adapter plugs with this unit. However, if it is necessary to use an extension cord, use an approved "Dehumidifier" extension cord only (available at most local hardware stores).
- To avoid the possibility of personal injury, always disconnect the power supply to the unit, before installing and/or servicing.

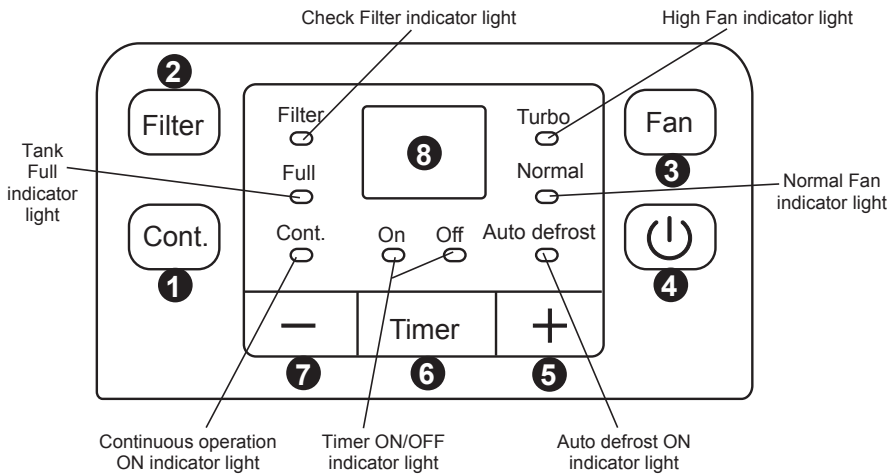
Control Panel



- 1 Continuous Operation**
Press to activate for continuous dehumidifier operation.
- 2 Filter**
The Check Filter indicator light will come on after 250 hours of operation. After cleaning and replacing the filter, push "Filter" to reset and the light will go off.
- 3 Fan**
Press to select either High or Normal fan speed. Set to High for maximum moisture removal. When humidity has been reduced (or quieter operation is preferred) set to Normal.
- 4 Power ON/OFF**

- 5 7 Adjustment Keys**  
- SET HUMIDITY: From 35% to 85% RH (Relative Humidity) in 5% increments. For drier air, press " - " to set a lower percent value. For damper air press " + " to set a higher percent value.
- SET TIMER: Set Auto Start and Auto Stop values from 0.0 to 24.
- 6 Timer**
Press to initiate the Auto Start and Auto Stop feature. Use the " - " and " + " keys to set values.
- 8 Digital Display**
Shows humidity levels (35-80%) or timer settings (00-24) while setting. Also displays actual room humidity levels (30-90% Relative Humidity) during operation (±5% accuracy).



NOTE: The Control Panel on the unit you purchased may be slightly different than shown.

Control Panel

OTHER FEATURES

- **Tank Full Light:** Glows when tank is full, removed or positioned incorrectly.
- **Check Filter Light:** The system begins counting the time when the fan motor switches on. At 250+ hours of operation, the "Filter" light flashes once per second to indicate air filter cleaning is necessary. After cleaning and replacing the filter, press the "Filter" key and the light will go off.
- **Auto Shut Off:** Dehumidifier shuts off after 30 seconds when the water tank is full, missing or positioned incorrectly. Also, the unit will shut off automatically when desired humidity setting is reached (on some models the fan motor may continue running).
- **3 Minute Delay:** After the unit is stopped, it will not resume operation until 3 minutes have passed to protect internal components.
- **Auto Restart:** If the unit stops due to a power outage, it will automatically resume operation at current settings when power is restored.

SETTING THE TIMER (NOTE: Timer can be set with unit Power ON or OFF)

1. If power is ON, press the "Timer" key and the "Timer Off" indicator light illuminates, which indicates that the Auto Stop program is initiated. Press the "Timer" key again to initiate the Auto Start program. If power is OFF, press the "Timer" key and the "Timer On" indicator light illuminates. This indicates that the Auto Start program is initiated. Press the "Timer" key again to initiate the Auto Stop program.
2. When either the Auto Start or Auto Stop program is initiated, press the  or  keys to adjust times up or down in increments of 0.5 hour up to 10 hours – then at 1 hour increments up to 24 hours. Once set, the unit will count down the time remaining until it starts (or stops). NOTE: While you are adjusting times, each number will display and hold for only 5 seconds before the system automatically reverts back to displaying the previous humidity setting.
3. When the Auto Start and Auto Stop times are set within the same program sequence, the "Timer On" and "Timer Off" indicator lights illuminate to identify that both ON and OFF times are now programmed.
4. Turning the unit ON or OFF at any time or adjusting the timer setting to 0.0 will cancel the Auto Start and Auto Stop functions. When display window shows "P2" these functions will also be cancelled.

ERROR/PROTECTION CODES

- AS** – Humidity sensor error. Unplug unit and plug back in. If error repeats, call for service.
- ES** – Temperature sensor error. Unplug unit and plug back in. If error repeats, call for service.
- P2** – Water tank is full or in wrong position. Empty tank and replace correctly.
- EC** – Unit malfunction. Check to make sure working environment is between 41°F/5°C and 95°F/35°C. If so, and error repeats, call for service.

Parts Identification

FRONT

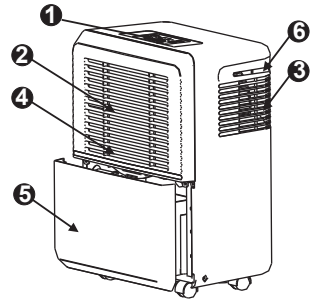

- ❶ Control Panel
- ❷ Air Intake Grille
- ❸ Air Outlet Grille
- ❹ Air Filter (behind the grille)
- ❺ Water Tank
- ❻ Top Carrying Handle (both sides)

REAR

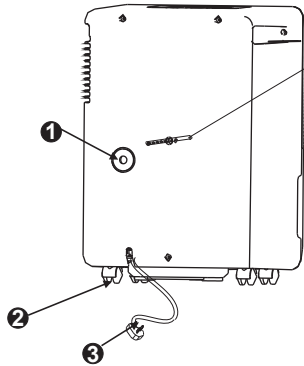

- ❶ Drain Hose Outlet
- ❷ Wheel Caster
- ❸ Power Cord and Plug
- ❹ Band (used only when storing the unit)

ACCESSORIES

Nipple (1)



Hose Adapter (1)

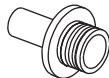

Screws (2)



NOTE: All illustrations in this manual are for explanation purposes only. The appearance of the unit you purchased may be slightly different, but the operation and functions are the same.

Placement and Operation

PLACEMENT

This unit must be operated in an enclosed area to be most effective. Make sure to close doors, windows and other outside openings to the room. Do not place the unit near a clothes dryer, heater or radiator.

NOTE: Operating the unit in a basement will have little or no effect in drying an adjacent enclosed area (such as a closet) unless there is adequate air circulation in and out of the adjacent area.

- Do not use outdoors.
- This dehumidifier is intended for indoor residential use only. It should not be used for commercial or industrial applications.
- Place the dehumidifier on a smooth, level surface strong enough to support the unit with a full tank of water.
- Allow at least 8" (20cm) of air space on all sides and 16" (40cm) above for adequate air circulation. (Fig. 1)
- Place the unit in an area where the temperature will not fall below 41°F/5°C. The coils can become covered with frost below 41°F/5°C, which may reduce performance.

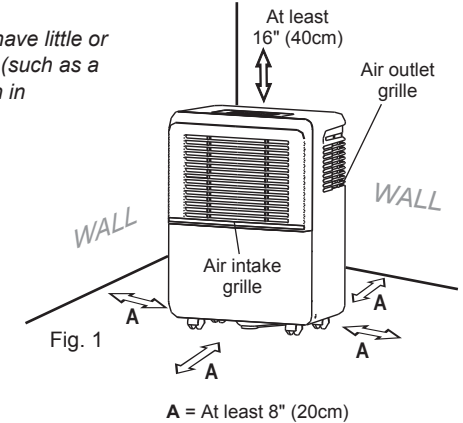

NOTE: Make sure wheel casters can move freely. Do not force the unit over carpet or move it with water in the bucket or it may tip over and/or spill water.

OPERATION

- Plug the unit into a grounded electrical socket only.
- Do not connect the dehumidifier to an outlet being used for other electrical appliances.
- When first using the dehumidifier, operate it continuously for 24 hours.
- This unit is designed to operate in a working environment between 41°F/5°C and 95°F/35°C.
- If the unit is switched off and then switched on again quickly, allow approximately 3 minutes for previous operation to resume.
- Make sure the water tank is correctly fitted, otherwise the unit will not operate properly.

NOTE: Empty the water tank before moving the unit, otherwise it may tip over and spill water.

Removing Collected Water

WHEN THE INTERNAL TANK IS FULL

UNIT POWER OFF: 8 beeps, “FULL” indicator light flashes and “P2” displayed.

UNIT POWER ON: Compressor stops, fan turns off after 30 seconds, 8 beeps, “FULL” indicator light flashes and “P2” displayed.

To remove tank for emptying:

1. Grip both handles firmly, slowly pull the tank straight out of the unit so water doesn't spill. Do not place tank on floor because the bottom is uneven and it may tip over.
2. Dispose of water immediately, dry out any residual moisture in the tank and replace it back into the unit. Tank MUST be seated securely for operation (unit will restart when tank is correctly positioned).

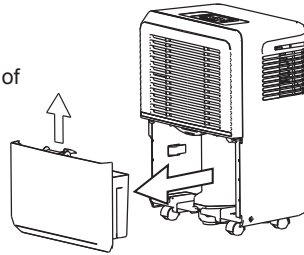

NOTE: Do not touch any parts inside the unit as it may cause damage. Use firm, gentle force when removing and replacing the tank. Banging the tank or seating it incorrectly may cause the unit to not operate.

CONTINUOUS DRAINING

Water can be automatically emptied into a floor drain by attaching a standard 5/16" ID water hose with female threaded end (not included).

Install Drain Hose Assembly

1. Push Nipple securely into Hose Adapter (Fig. 2)
2. Remove water tank. Remove Drain Hose Outlet Cap from Drain Hose Outlet on back of unit.
3. Insert Drain Hose Assembly all the way into Drain Hose Outlet on back of unit (Fig. 3).
4. Secure Drain Hose Assembly inside the unit by using the 2 screws provided. (Fig. 4)
Replace tank.

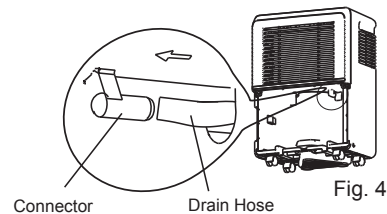
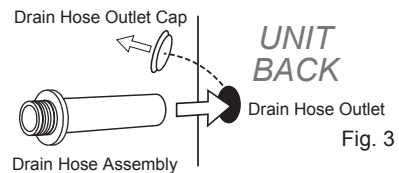
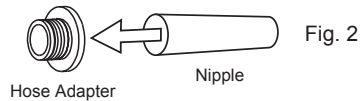

Attach Drain Hose:

1. Install the female threaded end of water hose onto Hose Adapter on back of unit (Fig. 5).
2. Route hose to a secure drainage location, making sure there are no kinks and the hose is draining flat or downhill from the unit.
3. Start humidifier.

NOTE: When continuous drain feature is not being used, remove water hose from Adapter.

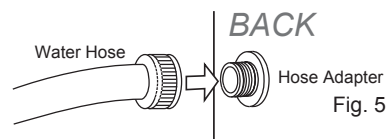

8

Care and Maintenance

Turn the dehumidifier off and remove the plug from the wall outlet before cleaning.

1. Clean the grille and case

- Use water and a mild detergent. Do not use bleach or abrasives.
- Do not splash water directly onto the main unit. Doing so may cause electrical shock, rust or deterioration of the insulation.
- The air intake and outlet grilles get soiled easily. Use a vacuum attachment or brush to clean.

2. Clean the water tank

Every few weeks, clean the water tank to prevent the growth of mold, mildew and bacteria. Partially fill the tank with clean water and add a little mild detergent. Swish it around in the tank, empty and rinse.

NOTE: Do not use a dishwasher to clean the tank. After cleaning, tank must be correctly placed and securely seated for the dehumidifier to operate.

3. Clean the air filter

- Remove and clean air filter every two weeks based on normal operating conditions.
- Remove the filter from the top of the unit (Fig. 6), or the bottom after removing tank (Fig. 7).
- Wash the filter with clean water, then dry. Re-install the filter and replace tank.

CAUTION: DO NOT operate the dehumidifier without a filter because dirt and lint will clog it and reduce performance.

4. Storing the dehumidifier

- After turning off the unit, wait one day before emptying the tank to allow all residual water to drain.
- Clean the main unit, tank and air filter.
- Wrap the cord and bundle it with the band (Fig. 8)
- Cover the unit with a plastic bag and store upright in a dry, well-ventilated place.

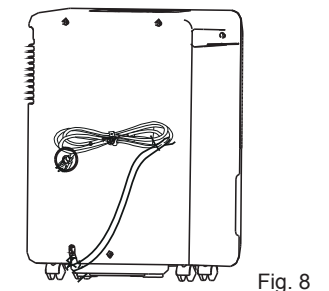
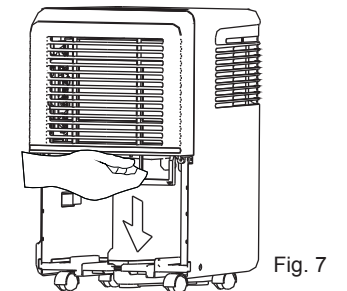
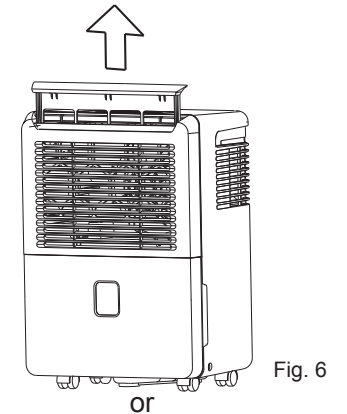

9

Troubleshooting Tips

Before calling service, review the chart below.
You may be able to quickly resolve the problem yourself.

Problem	What to check
Unit does not start	<ul style="list-style-type: none"> ● Make sure the dehumidifier's plug is pushed completely into the outlet. ● Check the house fuse/circuit breaker box. ● Dehumidifier has reached its preset level or bucket is full. ● Water bucket is not in the proper position.
Dehumidifier does not dry the air as it should	<ul style="list-style-type: none"> ● Did not allow enough time to remove the moisture. ● Make sure there are no curtains, blinds or furniture blocking the front or back of the dehumidifier. ● The humidity control may not be set low enough. ● Check that all doors, windows and other openings are securely closed. ● Room temperature is too low, below 41°F (5°C). ● There is a kerosene heater or something giving off water vapor in the room.
The unit makes a loud noise when operating	<ul style="list-style-type: none"> ● The air filter is clogged. ● The unit is tilted instead of upright as it should be. ● The floor surface is not level.
Frost appears on the coils	<ul style="list-style-type: none"> ● This is normal. The dehumidifier has Auto defrost feature.
Water on floor	<ul style="list-style-type: none"> ● Hose to connector or hose connection may be loose. ● Intend to use the bucket to collect water, but the back drain plug is removed.
ES, AS, P2 and EC appear in the display	<ul style="list-style-type: none"> ● These are error or protection codes. See the bottom of Pg. 5 in "Control Panel" section.

Warranty

Ideal Air Dehumidifier

Your product is protected by this warranty:

Warranty service must be obtained from Midea Consumer Services or an authorized Midea servicer.

Warranty

- One year full warranty from original purchase date.
- Limited 2nd through 5th year sealed system warranty*

Midea, through its authorized servicers will:

- Pay all costs for repairing or replacing parts of this appliance which prove to be defective in materials or workmanship.
- *For limited 2nd through 5th year sealed system warranty, Midea will replace any part in the sealed refrigeration system (compressor, condenser, evaporator and tubing) which proves to be defective in materials or workmanship.

Consumer will be responsible for:

- Diagnostics, removal, transportation and reinstallation cost required because of service.
- Costs of service calls that are a result of items listed under **NORMAL RESPONSIBILITIES OF THE CONSUMER****

Midea replacement parts shall be used and will be warranted only for the period remaining on the original warranty.

NORMAL RESPONSIBILITIES OF THE CONSUMER**

This warranty applies only to products in ordinary household use, and the consumer is responsible for the items listed below:

1. Proper use of the appliance in accordance with instructions provided with the product.
2. Routine maintenance and cleaning necessary to keep the good working condition.
3. Proper installation by an authorized service professional in accordance with instructions provided with the appliance and in accordance with all local plumbing, electrical and / or gas codes.
4. Proper connection to a grounded power supply of sufficient voltage, replacement of blown fuses, repair of loosen connections or defects in house wiring.
5. Expenses for making the appliance accessible for servicing.
6. Damages to finish after installation.

EXCLUSIONS

This warranty does not cover the following:

- 1) Failure caused by damage to the unit while in your possession (other than damage caused by defect or malfunction), by its improper installation, or by unreasonable use of the unit, including without limitation, failure to provide reasonable and necessary maintenance or to follow the written Installation and Operating Instructions.
- 2) Damages caused by services performed by persons other than authorized Midea servicers; use of parts other than Midea replacement parts; obtained from persons other than such Midea customer service; or external causes such as abuse, misuse, inadequate power supply or acts of God.
- 3) If the unit is put to commercial, business, rental, or other use or application other than for consumer use, we make no warranties, express or implied, including but not limited to, any implied warranty of merchantability or fitness for particular use or purpose.
- 4) Products without original serial numbers or products that have serial numbers which have been altered or cannot be readily determined.

Note: Some states do not allow the exclusion or limitation of incidental or consequential damages. So this limitation or exclusion may not apply to you.

IF YOU NEED SERVICE

Keep your bill of sale, delivery slip, or some other appropriate payment record. The date on the bill established the warranty period should service be required. If service is performed, it is your best interest to obtain and keep all receipts. This written warranty gives you specific legal rights. You may also have other rights that vary from state to state. Service under this warranty must be obtained by following these steps, in order:

1. Contact Midea Consumer Services or an authorized Midea servicer at 1-866-646-4332.
2. If there is a question as to where to obtain service, contact our consumer relations Department.