

USER GUIDE

1. Please pull the levers upwards when adjusting the height and reclination of the chair. Do not push the levers downwards;
2. Please be careful when adjusting the backrest angle to avoid violent movement of the backrest;
3. This chair is for sitting only. Do not use as a stepstool, wheelchair or other purposes;
4. Please do not sit close to the front of the chair;
5. This chair is designed for only one person's use at a time;
6. Please do not sit on the armrests;
7. Avoid leaving the chair in direct sunlight to prevent fading;
8. Clean with gentle cleansers if necessary. Do not scrub excessively;
9. All parts should be checked regularly to ensure this chair is safe to be used;
10. Stop using the product immediately if the chair is found to be damaged. Please check the maintenance guide on our website or contact us via email sales@zenoxstore.com for more information.

用戶須知

1. 當調整座椅角度和高低時，請向上拉動坐椅右方和下方的把手，切勿用力向下推；
2. 使用座椅之調角器時，請小心使用以防椅背回彈過快和夾手；
3. 本產品為座椅，請勿作為梯子或輪椅等其他物品使用；
4. 請勿坐在座椅的前方，以免座椅向前翻；
5. 本座椅只供單人使用，請勿站立或跪在座椅上；
6. 切勿坐在座椅的扶手上；
7. 請避免陽光直接照射及放在強光下暴曬，以防塑膠老化；
8. 清潔座椅時，請勿使用具腐蝕性的清潔劑及大力磨擦，以免損傷面料；
9. 請定期檢查座椅螺絲等零件是否鬆脫，確保使用安全；
10. 如發現產品零件有異常或損壞時，請立即停止使用，並聯絡本公司。如有任何查詢，請瀏覽網頁上的保養資訊或電郵sales@zenoxstore.com。

Need help with assembling your chair? Check out the video guides on our website!
需要技術支援？即上Zenox官方網頁觀看安裝示範短片！
<https://www.zenoxstore.com/pages/assembly-guides>

官方網站：<https://www.zenoxstore.com>
查詢熱線：(+852) 65634820
查詢電郵：sales@zenoxstore.com



ZENOX

got your back on every mission



SATURN RACING CHAIR

INSTALLATION MANUAL

READY TO GO

(A)

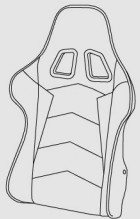

Backrest x 1

(B)

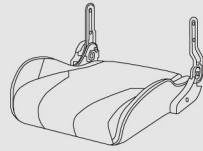

Seat x 1

(C)

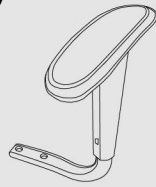

Armrest x 2

(D)

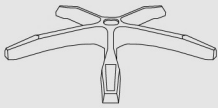

Base x 1

(E)

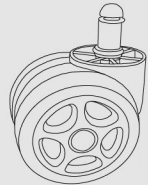

Wheels x 5

(F)

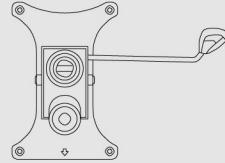

Tilt mechanism x 1

(G)

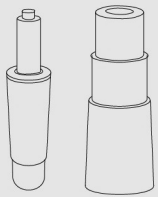

Gas lift/ Cover

(H)

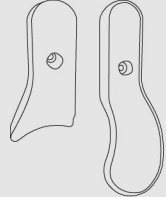

Backrest covers x 2

(I)

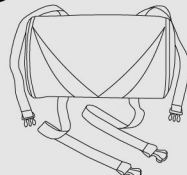

Lumber pillow x 1

(J)



Head pillow x 1

(K)

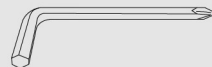

Universal tool x 1

(L)

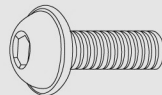

(M8*18mm) x 12

(M)

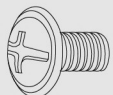

Philips screws x 2

(N)



Flat washers x 12

(O)

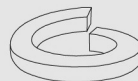

Lock washers x 12

Step 1

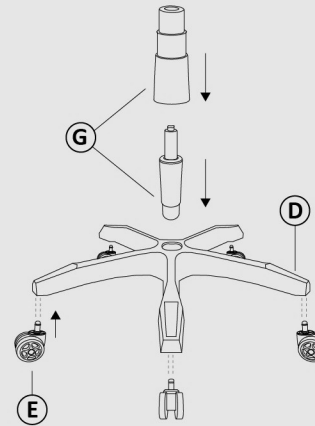

Step 2

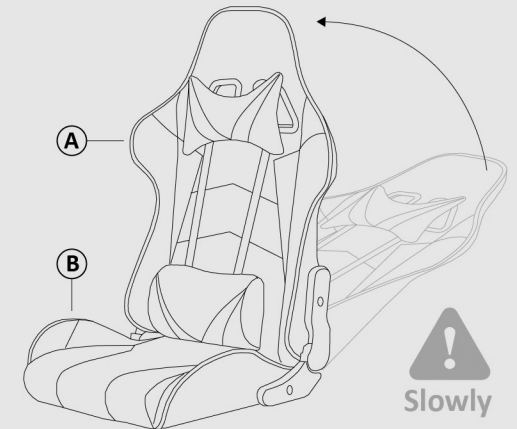

Step 3

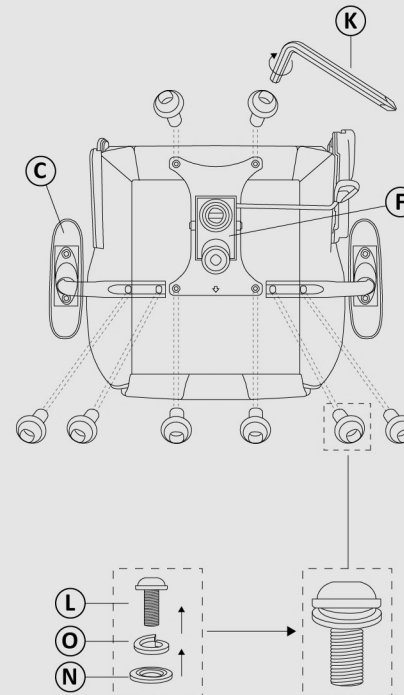

Step 4

