

SUPPORT

Contact us via email at aftersales@zenoxstore.com, or WhatsApp™ at +852 8481 7841.
如有需要請以電郵或WhatsApp™跟我們聯絡。



HEAVY

The product is considerably **heavy**, grab a friend and do the installation together if possible.
產品有一定重量，如果可以找個朋友幫忙安裝。



CAUTION

Stop using the product with damaged parts.
如發現產品有損壞，請立刻停止使用。

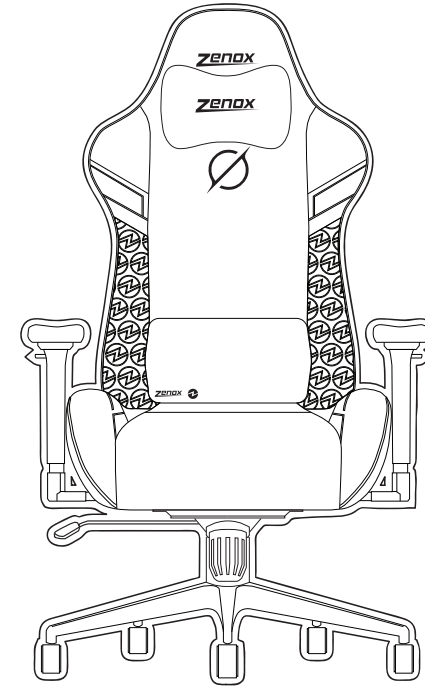

Sit in the center of the chair, back against the backrest.
請坐於椅子中間，背靠椅背。



Be Careful when using the recliner and other moving parts of chair.
請小心使用調角器和其他移動部件。



Do Not Sit at the edge of the chair, as it will tilt the balance.
請勿坐於椅子邊，造成傾倒危險。



Avoid Direct Sunlight as it would cause fading and damage the upholstery.
避免陽光直接照射產品，導致面料損壞。



Do Not Stand on the chair, and use it as any form of stool or ladder.
請勿站在椅子上，或當成梯子或腳踏使用。



Avoid Strong Chemicals or scrubbing excessively, as it would cause fading and damage the upholstery.
避免使用強烈清潔劑或大力摩擦，導致面料損壞。



Assemble Videos
www.zenoxstore.com/pages/assembly-guides

www.zenoxstore.com
(+852) 65634820
sales@zenoxstore.com

Congratulations.
Let's get started.

Package Content

- A - 1 Set of Pillows (2pcs)
 - B - 1 Backrest
 - C - 1 Seat assembly with armrests
 - D - 1 Set of armrest covers (2pcs)
 - E - 1 Class-4 gaslift with covers
 - F - 1 Wheelbase
 - G - 1 Set of casters (5pcs)
 - H - 1 Tilt mechanism
 - I - 1 Set of backrest side covers (2pcs)
 - J - 1 Hex key
- *Bolts are pre-installed, remove and reuse.**
***安裝前請先把部件螺絲移除，組合時再裝上。**

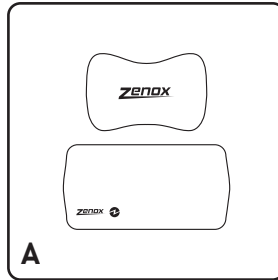
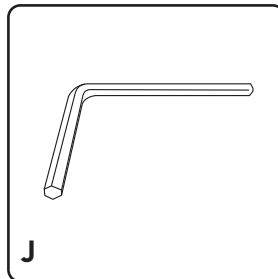
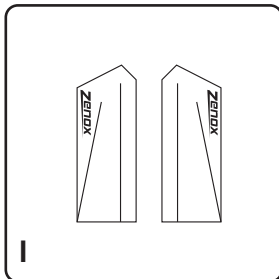
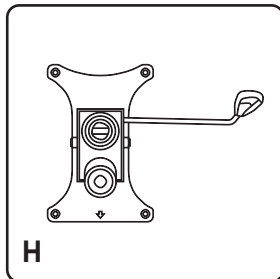
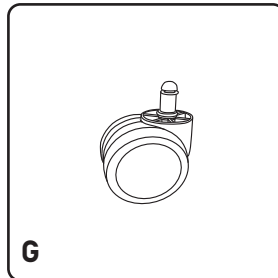
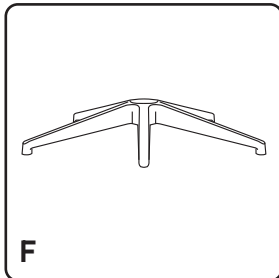
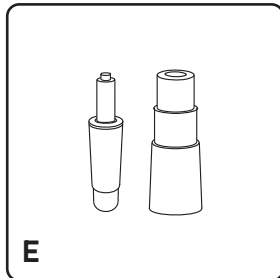
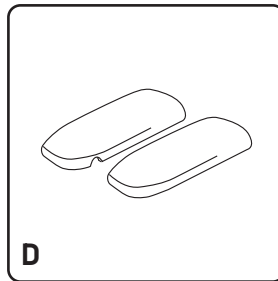
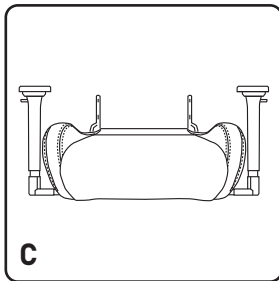
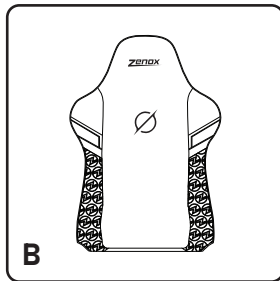

Step 01

Put together the base.
把底座組合。

Step 02

Side and align the backrest and seat.
把椅背和座墊組合。

Step 03

Remove the bolts and install the tilt-mechanism.
用部件上的螺絲把托盤裝上。

Step 04

Clip on the backrest side covers.
把椅背膠蓋裝上。

**WARNING
MAGNET INSIDE**

Step 05

**WARNING
MAGNET INSIDE**

Put together the seat base and pillows.
把座椅和底座及頭腰枕裝上。

Complete