



poco



Poco 3 User Guide

This document covers the Poco 3 module only.
For information on all previous versions of Poco refer
to the Poco Legacy document on our website.

lumiteclighting.com

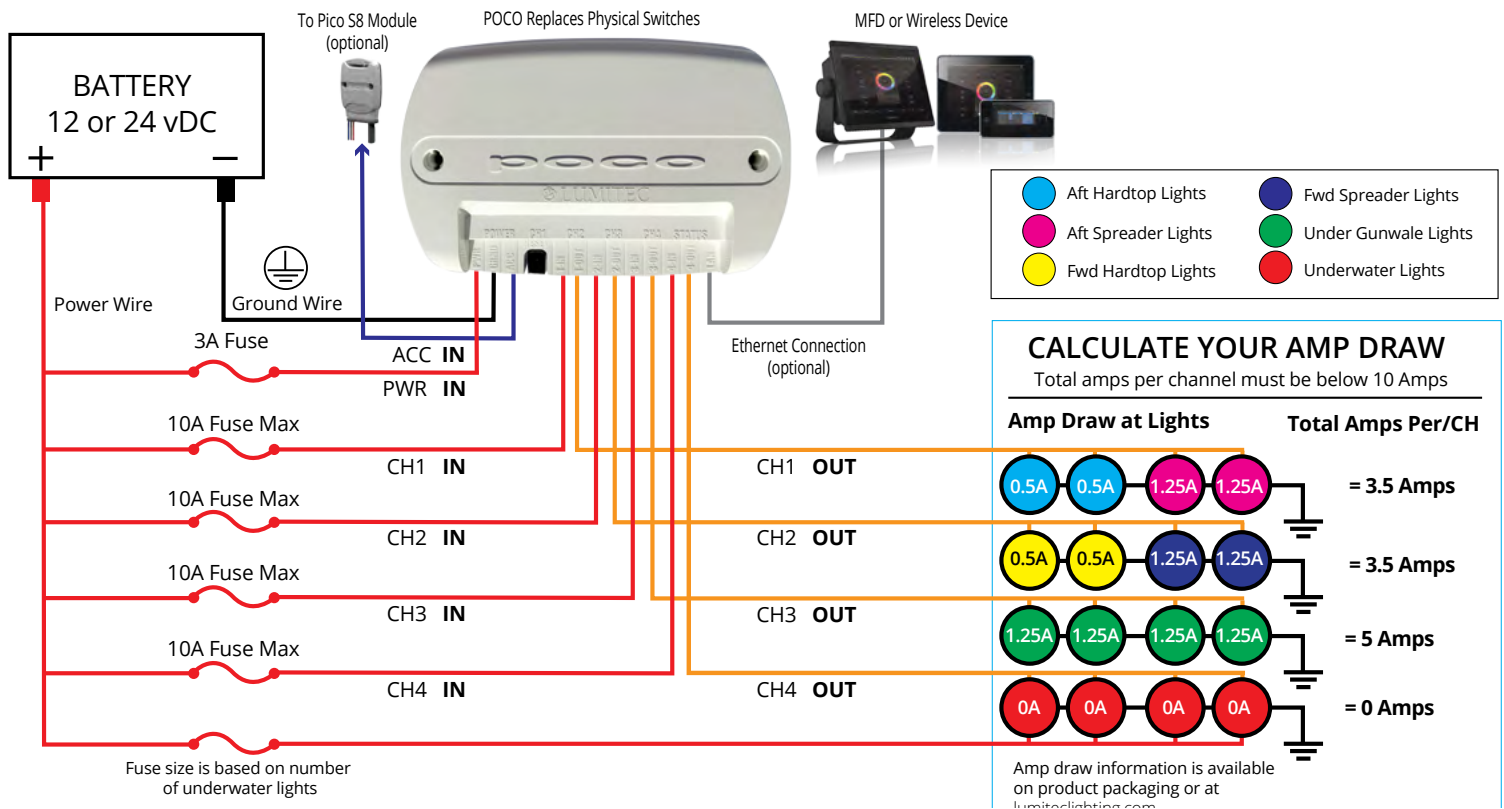

Table of Contents

QUICK START

Poco 3 Quick Start Guide

1. Install Poco Module: Install your Poco module using the wiring diagram below.



2. Connect to Poco:

- A. Poco can be connected to a chart plotter (MFD) and/or a mobile device.
- B. For an MFD connect the network cable to a compatible display. For a list of compatible displays visit: <http://lumiteclighting.com/poco-quick-start>
- C. For mobile devices connect using the Lumitec Poco App available on Apple or Google Play stores. You will be prompted to connect to Poco on launching the app.

3. Create Light Groups:

Select configuration in the setting menu (top right of screen). Assign Channel and Clan for each light location on your boat (underwater lights, spreaders lights etc.).

Examples:

Name: LG_aft_hardtop
Channel: 1
Clan: 1 - Down Lights
Output: Lumitec Spectrum

Name: LG_aft_spreader
Channel: 1
Clan: 2 - Flood Lights
Output: Blue / White

Name: LG_fwd_hardtop
Channel: 2
Clan: 1 - Down Lights
Output: Lumitec Spectrum

Poco Quick Start Guide

4. Create Switches (configuration menu). Assign a default intensity and color to each switch.

Example Simple Switch:

Name: Aft Hardtop	Intensity: 50%	Color: Red
Target: LG_aft_hardtop		

You can create lighting scenes by assigning multiple light groups to more than one target.

Example Scene Switch:

Name: Night Fishing	Intensity: 20%	Color: Red
1. Target: LG_aft_hardtop,	Intensity: 20%,	Color: Red
2. Target: LG_fwd_hardtop,	Intensity: 20%,	Color: Red
3. Target: LG_underwater	Intensity: 100%,	Color: Green

5. Add Switches to Layout Page:

- A. Select a location screen for your switch.
- B. Select the plus (+) button symbol.
- C. Select desired switch from list.

Note: Visual order of switches will be arranged by the order of the switch placement on layout. Switches cannot be rearranged after they have been added to a screen, only deleted. Go to <http://lumiteclighting.com/poco-quick-start> for more detailed information..

6. Check Status Indicators:

- POWER Indicator - Illuminates Green if POCO is powered on, PWR line must have supply voltage between 10-30vDC.
- CH1, CH2, CH3 or CH4 Indicator –
 - Illuminates Red if power is supplied to channel from fuse/breaker panel.
 - Illuminates Green if power is supplied to channel input and channel is turned on inside of POCO controller; (PLI enabled lights may be OFF even if there is power on the wire).
 - Flashes Orange if PLI data is transmitted.
 - Illuminates Orange if channel is dimmed through a PWM signal.

STATUS Indicator -

- Green blinking light indicates WiFi connection status:
- 0 blinks: WiFi disabled.
- 1 blink: WiFi enabled but not connected to any peers.
- 2 blinks: WiFi is connected to one or more peers.

STATUS Indicator -

- Blue blinking light indicates Bluetooth connection status:
- 0 blinks: Bluetooth disabled.
- 1 blink: Bluetooth enabled but not connected to any peers.
- 2 blinks: Bluetooth is connected to one or more peers.

SPECIFICATIONS

Supported MFD Models

MANUFACTURE	MODEL	CONNECTION TYPE	ADAPTER CABLES
Garmin	8400, 8600, GPSMAP 7-9X3, GPSMAP 8X10-24	WiFi/Ethernet	Not Required
Simrad	NSO EVO3/S, NSO EVO2, NSS EVO3, IDS, GO	Ethernet Only	Required (Check MFD Manual)
B&G	Zeus3/S Glass Helm, Zeus3/S, Vulcan	Ethernet Only	Required (Check MFD Manual)
Lowrance	HDS Live, HDS Carbon, Elite FS	Ethernet Only	Required (Check MFD Manual)
Raymarine	Axiom, Axiom Pro, Axiom XL	Ethernet Only	Required (Check MFD Manual)

Dimensions

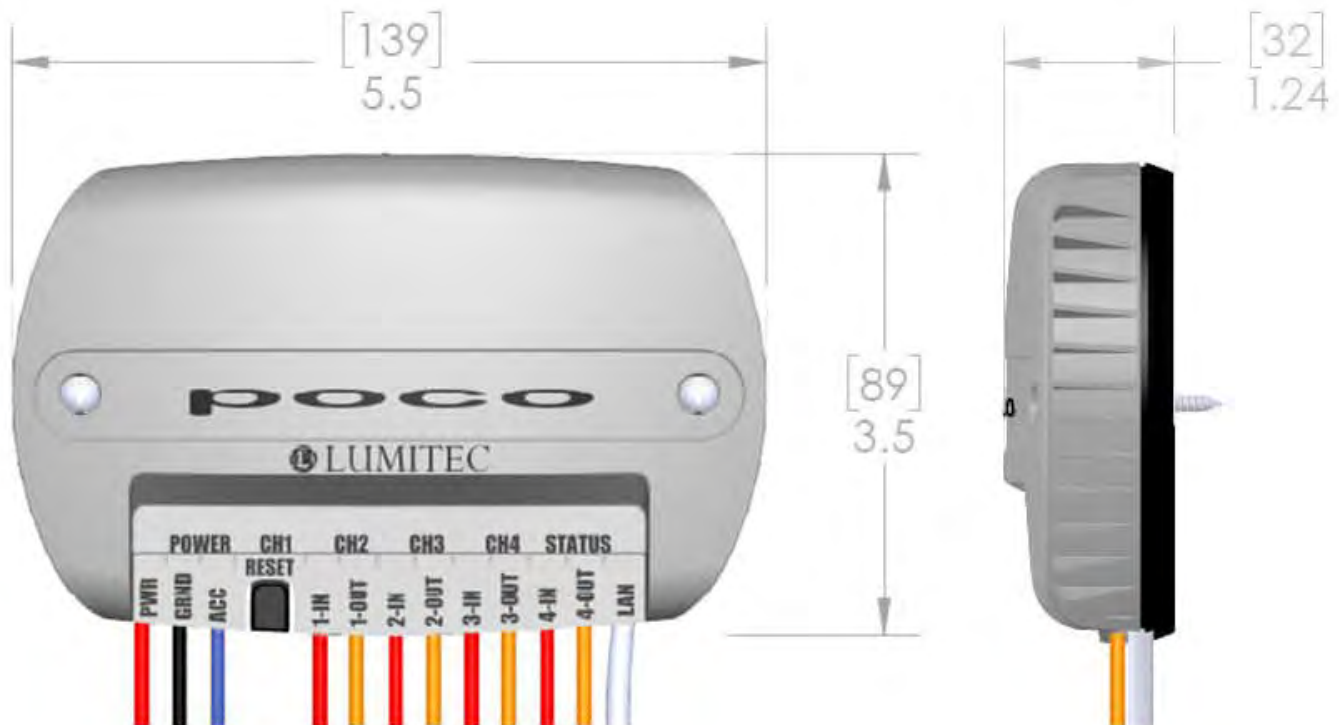

SPECIFICATIONS

continued...

Features

FEATURES	INDICATOR	DESCRIPTIONS
PWR	Red Wire	Positive 10-30 VDC POCO logic supply power. Line must be fused prior to connecting to POCO with 3 Amp ATC blade fuse or equivalent.
GRND	Black Wire	Supply Power Ground (Battery negative terminal).
ACC	Blue Wire	Poco Accesory Bus blue wire to connect to Pico S8 modules.
RESET	Button	See "RESET MODES" chart on page 6.
1-4 IN	Red Wires	Channel Input power. Line must be fused prior to connecting to POCO with 10 Amp ATC blade fuse or equivalent (14 AWG 300V 16 inch long cable).
1-4 OUT	Orange Wires	Channel Output power to lighting circuit. Maximum 10 Amp load per channel. Maximum total load across all channels is limited to 40 Amps. Load on channel must be only one of the following: (Lumitec PLI enabled lighting/lighting capable of dimming (through PWM) / device requiring a standard ON-OFF circuit). (14 AWG 300V 16 inch long cable).
LAN	Ethernet Cable	Local Area Network connection. 10/100 Base-T data connection to POCO. Standard CAT-5 cable with RJ45 connector required to plug into sealed network cable adapter. (18 inch long cable with Link light).

POCO STATUS LIGHTS			
POWER	Green	Solid	POCO is powered on
CH1-4	Red	Solid	Red if power is supplied to Channel from fuse/breaker panel.
	Green	Solid	Channel has power on output wire.
	Orange	Flash	PLI data is being transmitted.
	Orange	Solid	Channel dimmed through a PWM.
	Not Illuminated	None	No power to channel input (Check fuse/breaker).
STATUS	Green	1 Flash	WiFi enabled but not connected.
		2 Flash	WiFi is enabled and connected.
	Blue	1 Flash	Bluetooth enabled but not connected.
		2 Flash	Bluetooth enabled and connected.
		Not Illuminated	WiFi and Bluetooth disabled within Poco.

Features

RESET MODES		
USER ACTION	FUNCTION	FEEDBACK
<p>Short-press while Poco is running. Must release before 5s.</p>	<p>Reboot poco (no change to settings).</p>	<p>No indication while holding down button. After release button, status LED turns solid 'aqua' color while booting. Then resumes normal pattern.</p>
<p>Press-hold for > 5s while Poco is running, then release.</p>	<p>Restore WiFi/BLE/Eth settings.</p>	<p>No indication while holding down button for the first 5 seconds, then rapidly blink Green/Blue until release button.</p>
<p>Press-hold while powering-on Poco. Hold for > 5s.</p>	<p>Factory restore all. - Wipes ota data partition; which disables booting to any OTA partitions. - Wipes internal fs (FAT) partition; which clears any user configuration. - Wipes nvs partition; which clears WiFi/BLE/Eth settings.</p>	<p>Status LED turns solid 'aqua' color while waiting for user to keep holding button. There is no indication that user has held down button long-enough. After release button, Status LED continues solid 'aqua' color while booting. Then resumes normal pattern.</p>

INSTALLATION

Mounting

NOTICE

POCO should be mounted in a location that is not exposed to extreme temperature conditions. This device is rated for operation at ambient temperatures between 0 F (-18 C) and 120 F (50 C) and is sealed against water ingress per IP65 standards. To prevent standing water, it is recommended to mount the POCO device on a vertical surface protected from continuous water exposure.

- Using the included hardware, you can surface mount the device close to a breaker panel or fuse block.
- Pre-drill mounting holes with appropriately sized bit depending on the material. Typically a #32 (.116 inch) or 3mm bit can be used for pre-drilling for the #6 self tapping screws.
- Ensure screw holes do not interfere with anything on the opposite side of the mounting surface.
- The location must allow room for routing, the connection of all cables, visibility of LED indicators and access to depress the reset button.

Connections

SUPPLY

Poco must be powered with a 10-30 VDC supply independently fused with a 3 Amp ATC blade fuse or equivalent (Not Provided).

ACC - Poco Accessory Bus Blue Wire

Connect to blue accessory bus wire to multiple expansion modules from Lumitec. Works with up to 4 Pico S8 Modules for expansion.

INPUTS

Notice: POCO is designed to switch DC voltages between 10 and 30 volts. Switching any AC line voltages or DC voltages higher than 30V is not permitted and failure to adhere to the input voltage requirement can cause serious injury and death.

Each channel is independently powered and switched inside the POCO device allowing for many different wiring methods depending on system requirements. Each input line must be fuse protected prior to the POCO digital switch with a 10 Amp ATC or equivalent protection device. Input voltage must be between 10 VDC and 30 VDC. Switching of AC or high voltage lines is not permitted without properly rated relay and integral flyback diode. Contact Lumitec for further information. POCO comes with 16 inches (400 mm) 14 AWG wire for each channel input. Use appropriately sized and sealed crimp terminals to connect with channel supply.

Connections

OUTPUTS

Each channel is capable of switching a 10 Amp load powered within 10 and 30 VDC. POCO comes with 16 inches (400 mm) 14 AWG wire for each channel input. Use appropriately sized and sealed crimp terminals to connect with each channel load. See System Design Considerations for further information on lighting system architecture.

WIRED NETWORK

10/100 Base-T network connection from POCO device with a standard Ethernet cable (not included) to a compatible display or MFD. If all network ports are used for other system components, a network switch must be used to split the network traffic between two or more networked devices.

System Design Considerations

In most cases, channels should be designated either a Lumitec PLI channel, standard PWM dimming channel or standard ON/OFF channel. Lumitec PLI controlled lighting reaches its fullest potential when this rule is followed. Lumitec PLI lighting has the ability to create “virtual circuits” where lighting on each PLI channel can be addressed with commands specific to each clan of lights. For example, SeaBlazeX2 or Typhoon lights can be attached to the same channel as Lumitec Mirage lighting and Caprera2 lighting as well as other clans of lights. Because each are digitally controlled over the two power wires you are able to communicate with light clans independently as if they were setup on multiple circuits.

QUICK TIPS:

- Lighting that is not PLI enabled on a channel that also has PLI enabled lights will stay in the ON state without dimming control, even when other lighting is sent PLI commands. This works well for situations where you want to connect a non-PLI Aurora Dome Light to the same circuit as PLI enabled lights. This setup will only work if the attached non-PLI lights have low internal capacitance or a series diode. Lumitec lights that will work in this configuration include Courtesy and Accent lighting as well as the Touch Dome Light and Aurora Dome Light.
- If PWM dimming control is being used on a channel, PLI enabled lights on that channel will respond as standard lights without digital color control.
- PWM dimming control is not compatible with some loads such as relays or inductive loads. For these situations, ensure all commands sent to these commands are ON/OFF only commands (see UI setup for further information).

INSTALLATION

continued...

Various System Configurations

These schematics are intended to be used as general guidelines. Wiring requirements will vary from vessel to vessel.

Note: The Pico S8 module provides the easiest way to connect mechanical switches to your Poco 3 device. See Fig. 4 for wiring diagram.

DIFFERENT LIGHT TYPES



(e.g., Down Light, Rail Lights, Underwater Lights, Etc.)

SYMBOL REFERENCE

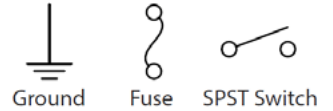

Ground Fuse SPST Switch

Fig. 1: Use of a single channel to control multiple light types within the lighting system

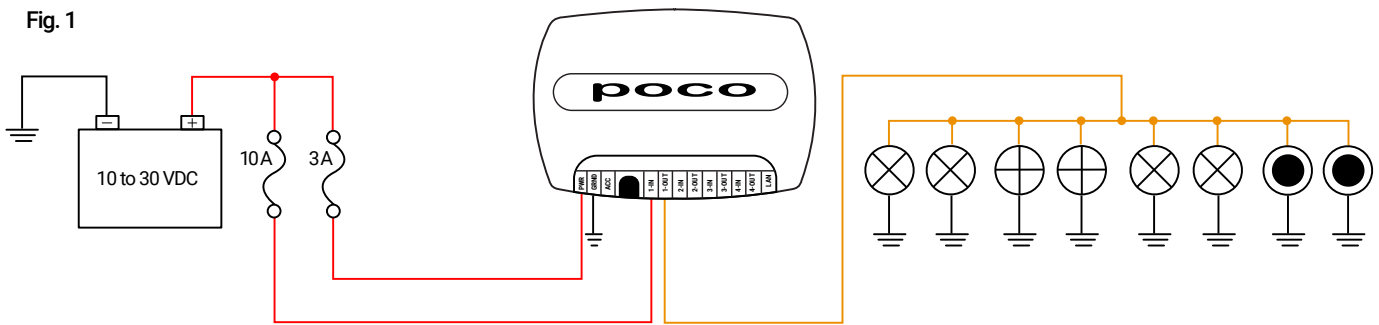

Fig. 2: Use of different channels to allow isolated control of a set of similar light types within the system

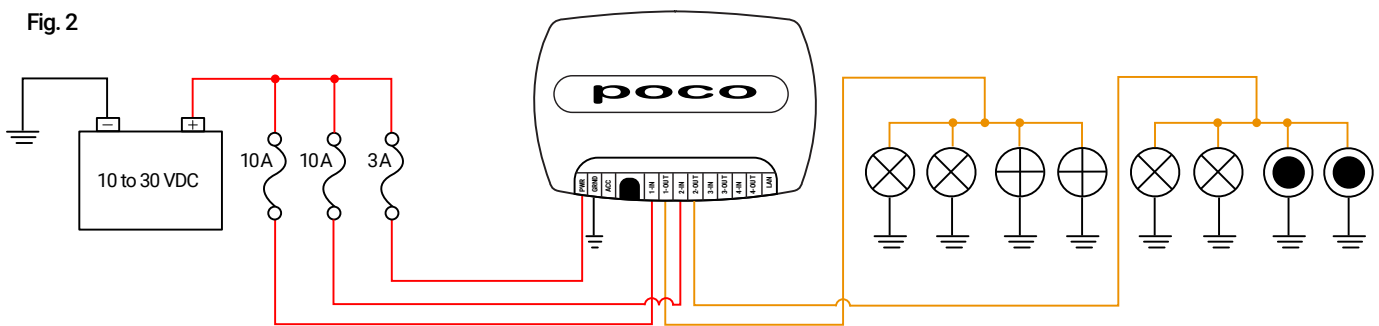
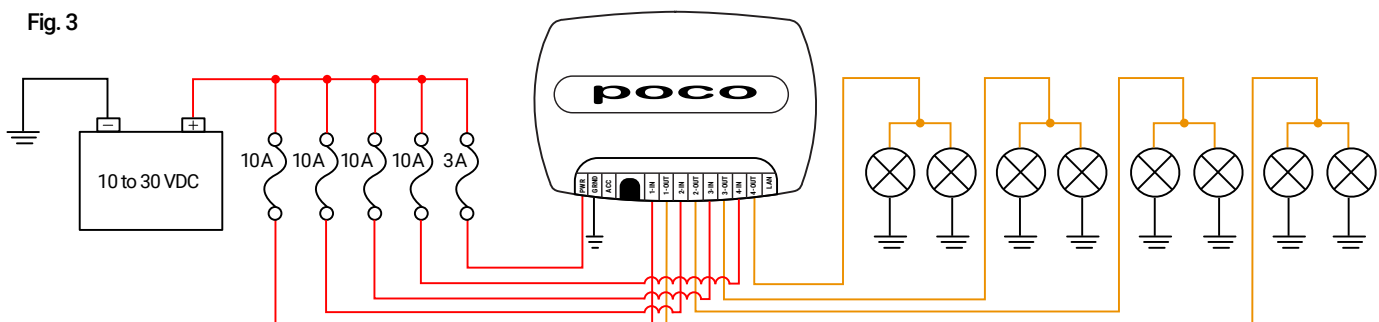

Fig. 3: Use of different channels to allow isolated control of PLI and PWM lighting



INSTALLATION

continued...

Fig. 4: Use of a Lumitec Pico S8 module to allow POCO to read the state of mechanical switches and send corresponding digital commands to lights.

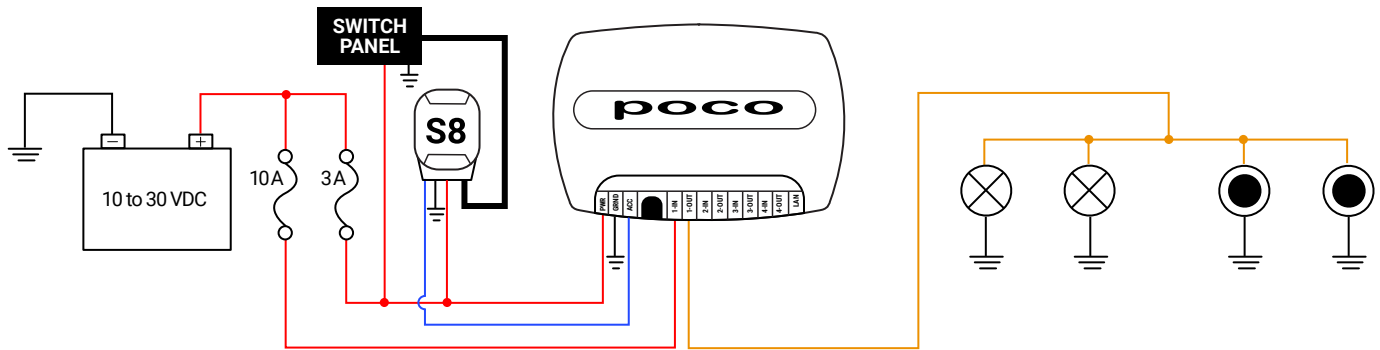

Fig. 5: Use of an SPST switch on a channel to allow for redundant mechanical control of a set of lights within the system allowing for standard Lumitec TTP control or POCO digital PLI control

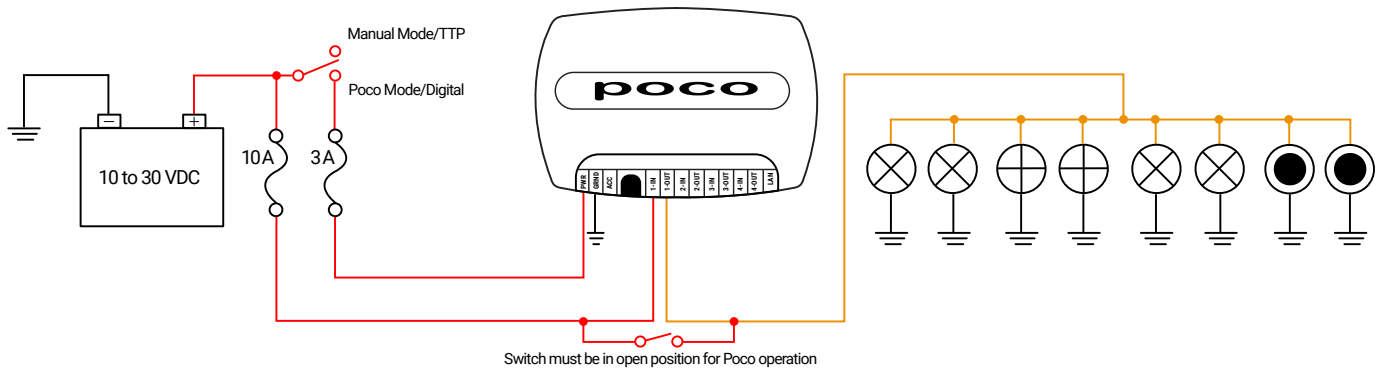

Fig. 6: Use of an SPST switch on each channel to allow for standard Lumitec TTP control as well as digital PLI control (non-redundant)
 Note: POCO will need to be configured with startup commands to turn on all 4 channels by default. Refer to "Startup Switch" under Automation section.

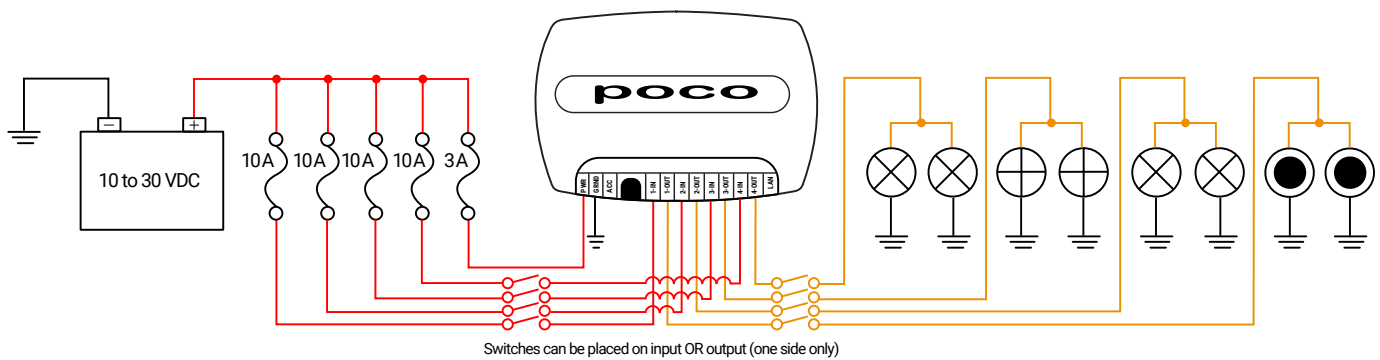
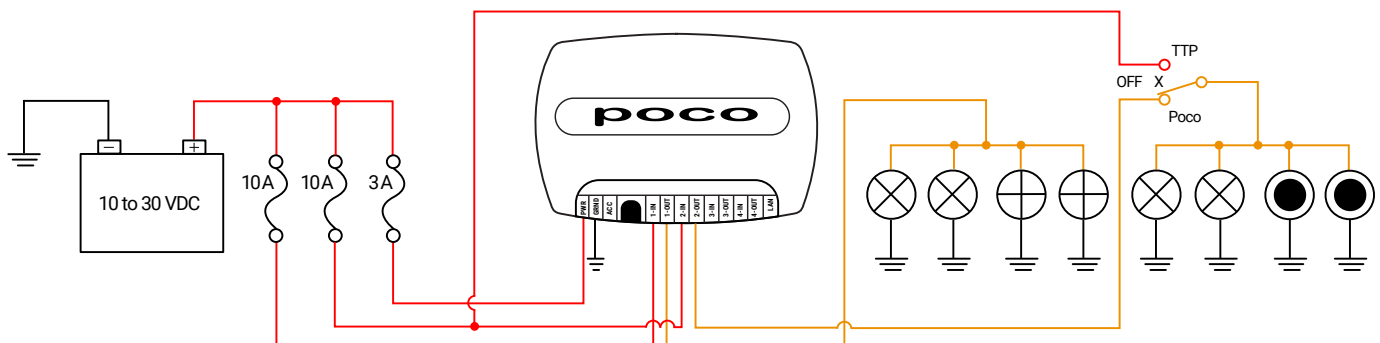

Fig. 7: Use of an SPDT switch prior to all lighting circuits to allow for redundant mechanical control of entire lighting system with one switch



User Interface Components



Latching or momentary ON/OFF switch with no ability to modify.



Omnillume switch with the ability to be modified from default intensity and color.

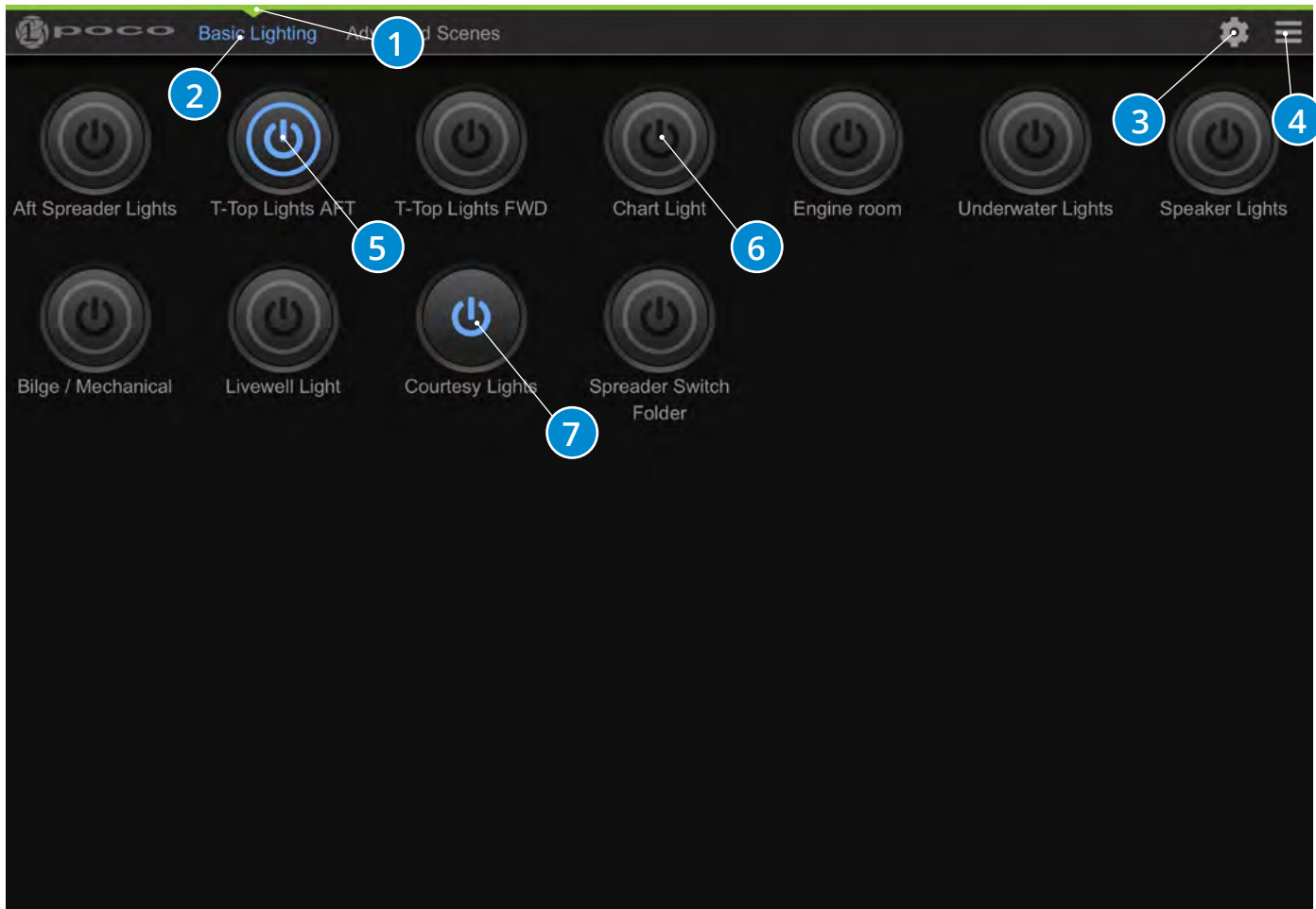

Switch Panel:

1. Active switch page.
2. Customizable name of switch pages.
3. Gear Icon - Configuration and setup.
4. Hamburger menu icon - Drop down menu of options.
5. Switch that has been turned on (blue highlighted icon).
6. Switch that has the ability to be modified from default intensity and color with a press and hold of the button (Notice ring around power logo). Switch has been configured as an Omnillume in switch setup.
7. Switch is either latching or momentary ON/OFF with no ability to modify (Notice NO ring around power logo).



Latching or momentary ON/OFF switch with no ability to modify.



Omnillume switch with the ability to be modified from default intensity and color.

Omnillume Widget

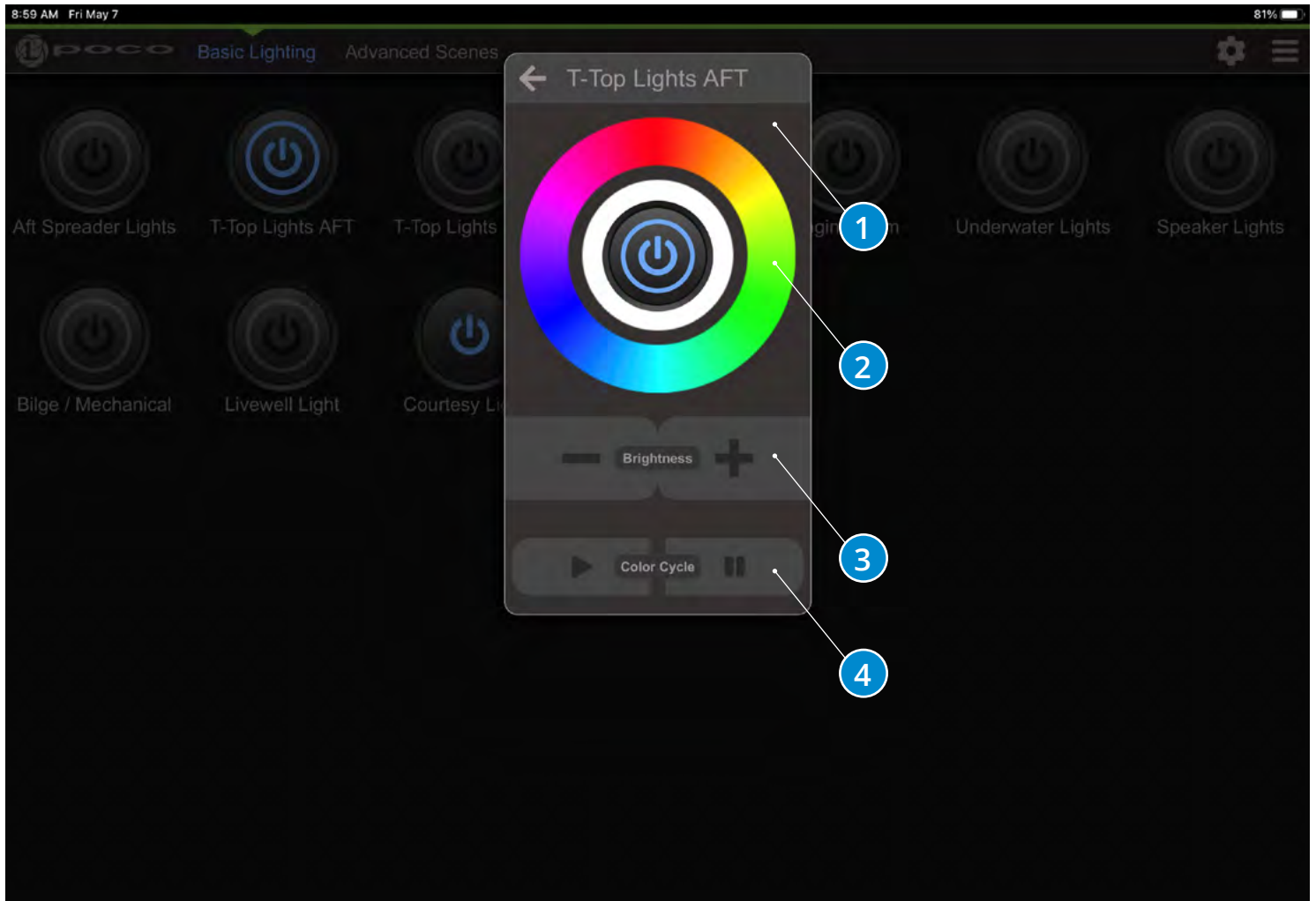

Omnillume Widget:

1. Switch modification popup that appears when an Omnilume switch is pressed and held for greater than 1 second.
2. Light color modification rings, press for desired color.
3. Light intensity modification.
4. Play and Pause pattern (available for Spectrum and Dual-Color lights).



Latching or momentary ON/OFF switch with no ability to modify.



Omnillume switch with the ability to be modified from default intensity and color.

Switch Folder Widget

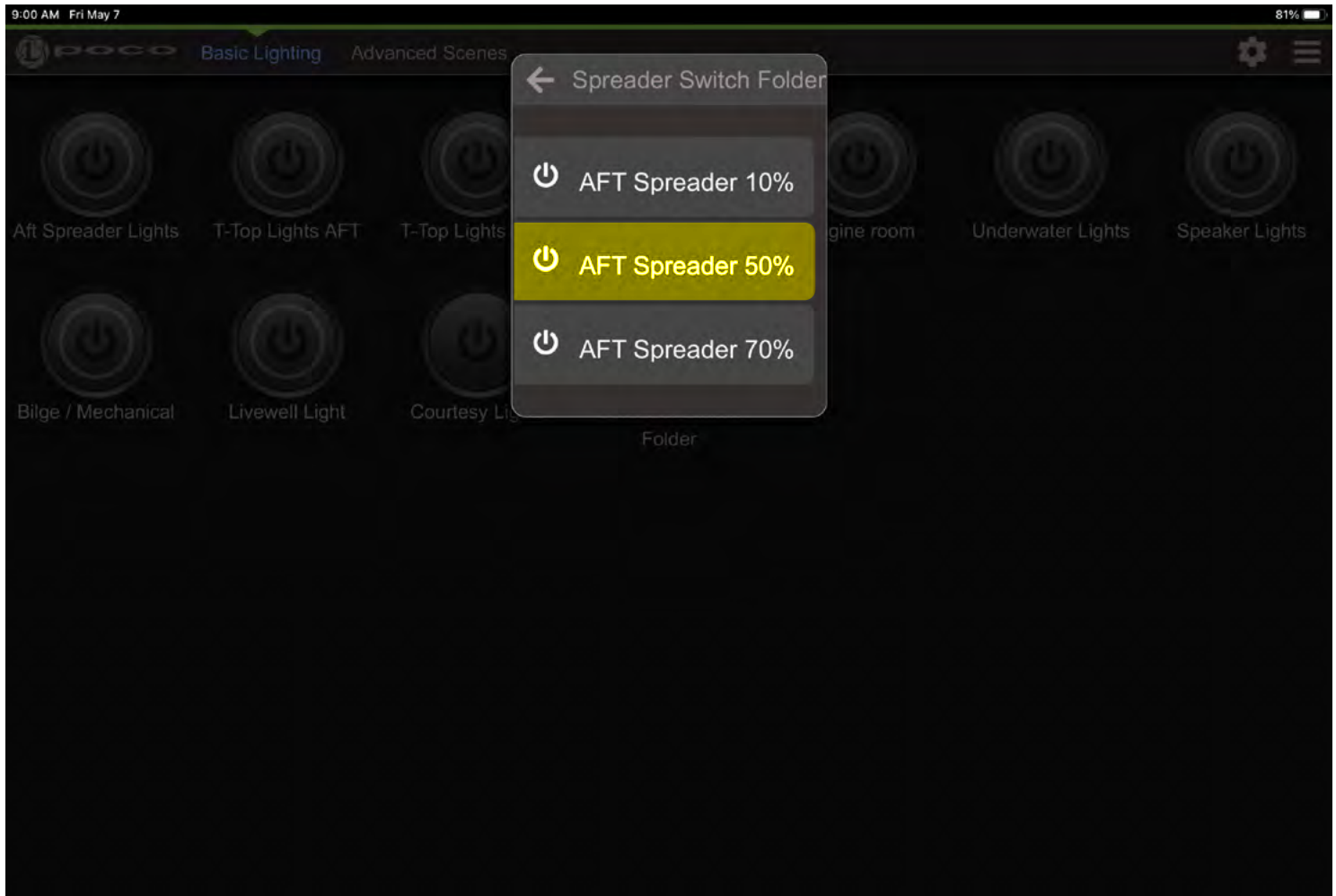

Switch Folder Widget:

- Switch Folder popup appears when a Switch Folder button is pressed and held.
- A quick press of a Switch Folder button will activate the first button in the list.
- Highlighted switch showing that switch is activated.

Scene Select



Latching or momentary ON/OFF switch with no ability to modify.



Omnillume switch with the ability to be modified from default intensity and color.

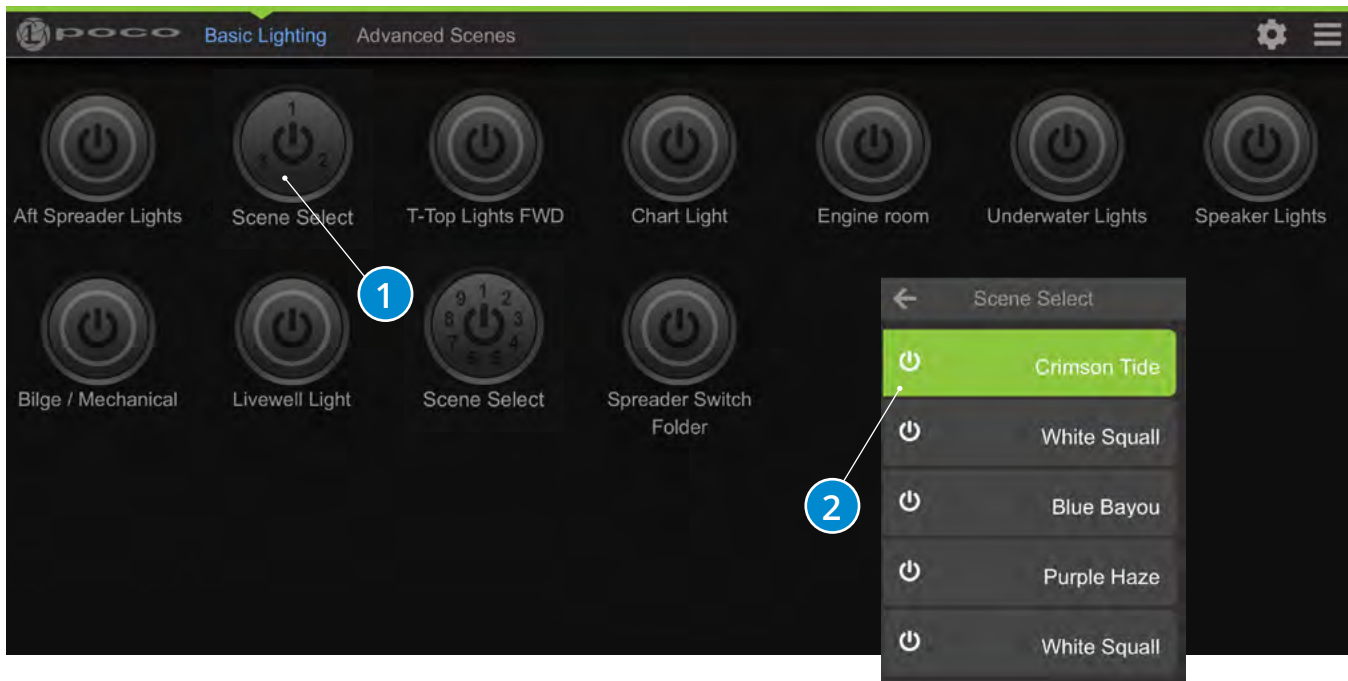

Scene Select:

- The Scene Select feature allows you to group multiple scenes within one switch.
 - Scene Select button contains multiple scenes.
 - A quick press of a Scene Select button will activate the first scene in the list
 - Change scenes by pressing the button within 4 seconds to cycle to next scene.
 - Pressing the button after 4 seconds will shut the switch off.
- Press and hold the switch to bring up the list of scenes available under the switch.

Note: Only one scene grouped within Scene Select can be active (ON) at any given time.

SETUP

Default Maintenance pin is set to "0000". This can be changed but must be done by manually editing the configuration file. See exporting and importing configuration below.

User Interface SETUP

The POCO setup menu is accessible through the gear wheel icon in the upper right of the user interface window.

Name	Channel	Clan	Output
LG Hardtop Aft	ch1	1: Down Lights	Lumitec Spectrum RGBW
LG Aft Spreader	ch1	2: Spreader Utility Lights	Two color, white and blue
LG Under Gunwale	ch1	3: Rail Lights	Lumitec Spectrum RGBW
LG Courtesy	ch2	Non-PLI Dimming	White
LG Engine Room	ch1	5: Mini Rail Lights	Lumitec Spectrum RGBW
LG Underwater	ch1	4: Underwater Lights	Lumitec Spectrum RGBW
LG Pico C4	ch1	7: Pico C-4	Lumitec Spectrum RGBW
LG Spreader 10%	ch1	2: Spreader Utility Lights	Two color, white and blue
LG Spreader 50%	ch1	2: Spreader Utility Lights	Two color, white and blue
LG Spreader 70%	ch1	2: Spreader Utility Lights	Two color, white and blue
LG Bilge/Mechanical	ch1	3: Rail Lights	Lumitec Spectrum RGBW
LG FWD Hardtop	ch4	1: Down Lights	Lumitec Spectrum RGBW
LG Chart Light	ch4	1: Down Lights	Lumitec Spectrum RGBW
LG Livewell	ch4	9: Livewell Lights	Lumitec Spectrum RGBW
+ Add Light Group			

List of configured Light Groups:

1. First step in system configuration is to define the "Light Groups".
2. Select a row to edit or select "+ Add New Item" to create a new "Light Group".

Note: Light Groups must be configured first before setting up switches.

User Interface SETUP



Add/Edit a Light Group:

1. User Configurable "Light Group" Name, Using a prefix like "LG" may help with future setup.
2. Hardware output channel on Poco. Gives the ability to send a command to all channels or each individual channel (1-4).
3. A PLI-level identifier for one or more devices. Clans are roughly organized around product families. Allows commands to be sent to all Clans or individual Clans in the list below.
4. Color capability of lights built into light group. This is the property that provides the correct color options for a light when a switch is pressed and held to bring up the omnillume widget.

Clans

CLAN	CLAN NAME	FAMILY OF LIGHTS
0	All PLI Lights	All Lights that are PLI Enabled.
1	Down Lights	Mirage, Orbit, Shadow (1- color, 2-color, 4 color, Spectrum).
2	Spreader Utility Lights	Spreader Lights and Utility Lights (Capri, Caprera, Nevis, Ibiza, Perimeter Light) .
3	Rail Lights 12"	Spectrum Only.
4	Underwater Lights	SeaBlaze X2 and Typhoon (Spectrum or Dual Color).
5	Mini Rail 6"	Spectrum Only.
6	Flex Lighting	Moray Flex Lights.
7	Pico C4	Control of Third-Party RGB(W) Lighting Accessories.
8	Pico P1	Solid State Relay (20A max. load).
9	Livewell Lights	Lutra Spectrum.
10	Pathway Dock Lights	Nautilus Pathway Lights (Spectrum and single color).
11	Piling Dock Lights	Scallop Piling Lights (Spectrum and single color).
N/A	Non PLI Dimming	All non PLI dimming lights.
N/A	Non PLI on/off	Turns all non PLI lights on or off.

Switches

Name	Switch Type	Target(s)
Aft Spreader Lights	Omnillume	LG Aft Spreader
T-Top Lights AFT	Omnillume	LG Hardtop Aft
Under Gunwale Lights	Omnillume	LG Under Gunwale
America	Omnillume	LG Hardtop Aft, LG Under Gunwale, LG Underwater
South Beach	Omnillume	LG Hardtop Aft, LG Under Gunwale
Blue Bayou	Omnillume	LG Hardtop Aft, LG Under Gunwale, LG Aft Spreader, LG Pico C4, LG Underwater
Crimson Tide	Omnillume	LG Under Gunwale, LG Hardtop Aft, LG Pico C4, LG Underwater
White Squall	Omnillume	LG Hardtop Aft, LG Under Gunwale, LG Pico C4, LG Underwater
Purple Haze	Omnillume	LG Hardtop Aft, LG Under Gunwale, LG Pico C4, LG Underwater
Scene Select	Scene Select	Blue Bayou, Purple Haze, Crimson Tide, America, South Beach
Livewell Light	Omnillume	LG Livewell
Spreader Switch Folder	Switch Folder	AFT Spreader 10%, AFT Spreader 50%, AFT Spreader 70%
Engine room	Omnillume	LG Engine Room
Underwater Lights	Omnillume	LG Underwater
Night Fishing	Omnillume	LG Hardtop Aft, LG Underwater
AFT Spreader 10%	Omnillume	LG Aft Spreader
AFT Spreader 50%	Omnillume	LG Aft Spreader

List of configured Switches

1. Second step in system configuration is to define the "Switches" and Scenes.
2. Select a row to edit or select "+ Add New Item" to create a new "Switch".

Switches



Add/Edit a Switch:

1. User Configurable "Switch" Name.
2. Type of Switch to define button action. See switch types in the list below.
3. Push to test commands in list, push again to issue off command to targets in list.
4. Push to create a copy of current switch and begin editing.
5. Light Group or Switch Selection. Light Groups are allowed to have intensity and color properties, switches cannot have any modification properties and are only activated in the order they appear in the list.
6. Light Intensity Selection 0% - 100%.
7. Color and Pattern Selection.

Scene Select

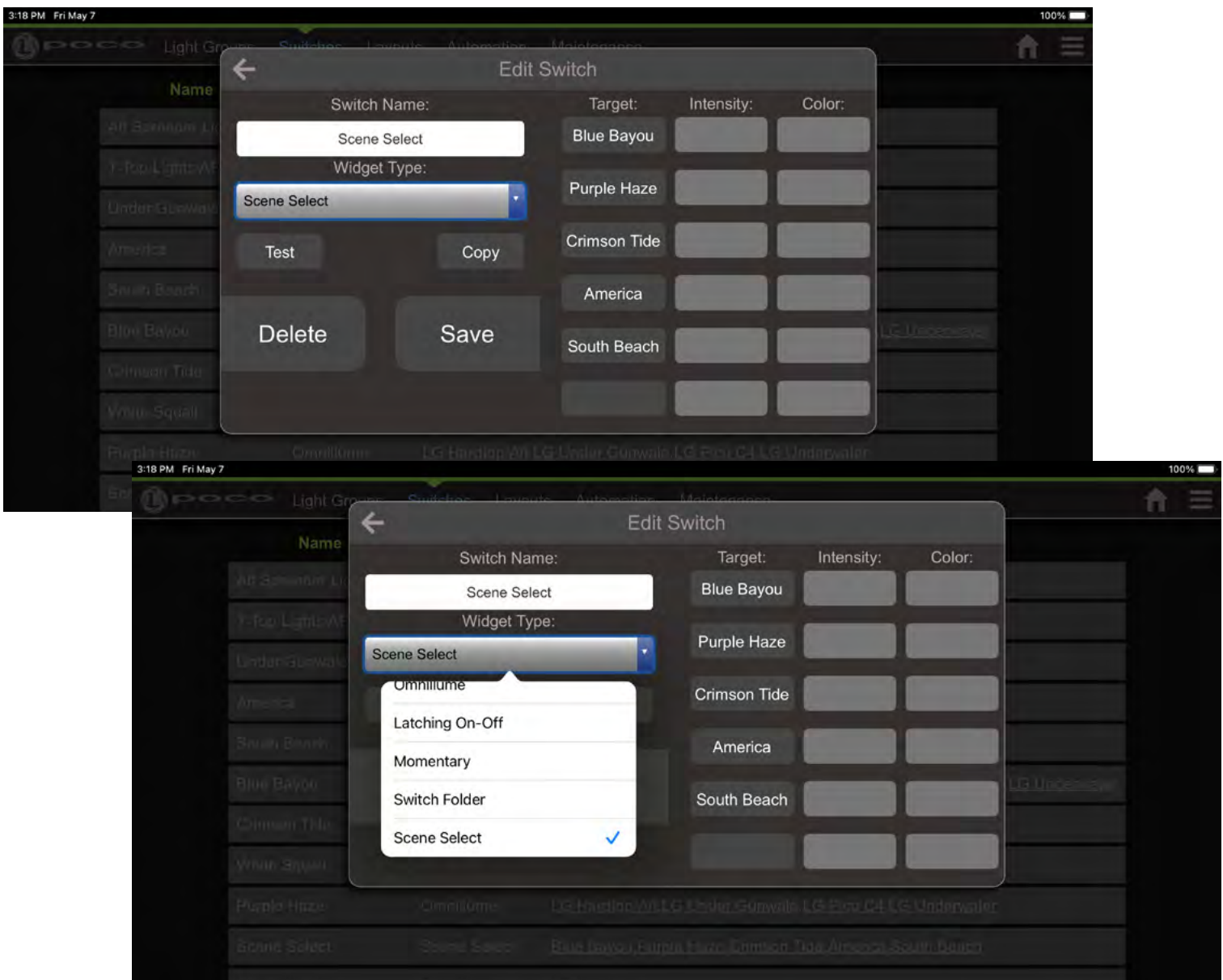

Scene Select:

The Scene Select switch type makes creating scenes easier.

- Set other Virtual Switches as the scene of a Scene Select switch
- Only one scene allowed "ON" at a time
- Use a single button (on screen or physical switch) to index through scenes

Switches

Switch Types

SWITCH TYPE	ACTION
Omnillume	Works like a standard on/off toggle switch but has the ability to modify color and brightness for the lights that are attached to it with a press and hold action of the button.
Latching On-Off	Standard toggle switch, Press button to turn On, Press again to turn Off.
Momentary	Standard Momentary switch, Press button to turn On, Release to turn Off. (Example: a Horn button).
Switch Folder	Acts as a folder to store previously defined switches that may have similar functionality. Works like a standard on/off toggle switch for the first switch in the list but has the ability to turn on and off other switches with a press and hold action of the button.
Scene Select	Acts as a collection of Scenes that have been created. Allows for grouping of Scenes on one switch. Works best when you only want one scene in the list ON at a time.

Tips & Tricks

Take note that it takes time to issue commands over the power lines so the more commands that are attached to a switch the more lag there will be from the issuing of the first command to the issuing of the last command.

If a switch is defined with Spectrum Lights and a 2-color White/Blue light the only options for color changing with a press and hold of the Omni-Llume button will be white and blue because the switch picks the least common color that the lights are capable of producing. In some instances, it may be desirable to define a simple PWM single color light such as Lumitec's accent lights as an RGBW Spectrum light so that if it is attached to a switch that creates a lighting scene, the lighting scene color may be adjusted via an Omnillume switch. The accent light will not change color but by identifying the light group as an RGBW Spectrum Light it will not prevent the full-color Spectrum Wheel from being displayed.

Layout

**Add/Edit a Layout:**

1. Layout configuration.
2. Switch page name (Press and hold to edit or delete name).
3. Add new switch page.
4. Press and hold to edit or delete switch.
5. Add new switch to layout.

Automation

The screenshot shows the POCO Automation interface. At the top, there are navigation tabs: Light Groups, Switches, Layouts, Automation (selected), and Maintenance. Below the tabs, the 'Start-up Switch' is currently set to 'none'. A button labeled 'Set Start-up Switch' is highlighted with a red circle and the number '1'. Below this, the 'Actions' section contains a table with the following data:

Act#	Switch	Triggers
1.	Underwater Lights	S8-D.6 uw Green Wire
2.	Aft Spreader Lights	S8-D.5 Yellow Wire
3.	T-Top Lights AFT	S8-D.8 White Wire
4.	Under Gunwale Lights	S8-D.3 Red Wire
5.	Engine room	S8-D.2 Brown Wire
6.	Scene Select	S8-D.1 Black Wire
7.	Livewell Light	S8-D.7 Blue Wire

Below the table is an '+ Add Action' button. At the bottom of the interface, there is a section for 'Wired Interface (Poco 3+)' with a toggle switch for 'Enable Pico-S8 Module Support' which is currently turned 'ON'. Below this toggle is another table:

Module Slot Name	Slot State	Status
Pico-S8 Slot A	Enabled	OK
Pico-S8 Slot B	Disabled	...
Pico-S8 Slot C	Disabled	...
Pico-S8 Slot D	Disabled	...

Startup Switch:

1. Defines a switch to be automatically activated when Poco is powered-on. This could be used to turn on some amount of lighting at power up like courtesy lighting or could be used to turn on all 4 channels as an ON/OFF switch when wired in series with SPST switches. This allows for rocker switches to be used as typical and PLI commands would modify the behavior of the connected lights. Note: Create and configure the switch as usual prior to selecting it here. Press reboot to test it.

Automation

The screenshot shows the POCO Automation interface. At the top, there are navigation tabs: Light Groups, Switches, Layouts, Automation (selected), and Maintenance. Below the tabs, there is a 'Start-up Switch: none' section with a 'Set Start-up Switch' button. The main area is titled 'Actions' and contains a table with the following data:

Act#	Switch	Triggers
1.	Underwater Lights	S8-D.6 uw Green Wire
2.	Aft Spreader Lights	S8-D.5 Yellow Wire
3.	T-Top Lights AFT	S8-D.8 White Wire
4.	Under Gunwale Lights	S8-D.3 Red Wire
5.	Engine room	S8-D.2 Brown Wire
6.	Scene Select	S8-D.1 Black Wire
7.	Livewell Light	S8-D.7 Blue Wire

Below the table is an '+ Add Action' button. The bottom section is titled 'Wired Interface (Poco 3+)' and contains a toggle switch labeled 'Enable Pico-S8 Module Support' which is currently turned ON. Below the toggle is a table with the following data:

Module Slot Name	Slot State	Status
Pico-S8 Slot A	Enabled	OK
Pico-S8 Slot B	Disabled	...
Pico-S8 Slot C	Disabled	...
Pico-S8 Slot D	Disabled	...

Red circles with numbers 2 and 3 are overlaid on the 'Slot State' column of the table, pointing to the 'Enabled' state of Slot A and the 'Disabled' state of Slot D, respectively.

The Pico S8 is an add-on expansion module designed to be integrated into your POCO digital lighting control system to add additional functionality, and allow you to assign POCO virtual switch commands to up to 32 physical switches.

Adding Pico S8 Module:

- To enable and configure a Pico S8 module go to the "Wired Interface" section under the Automation tab and toggle the "Enable Pico-S8 Module Support" switch to ON position. You should now see 4 available slots to assign modules. There are only 4 slots available giving the ability to connect a maximum of 4 Pico S8 modules per POCO system.
- Select an empty slot to open the "Edit Interface Module dialog box".

Automation

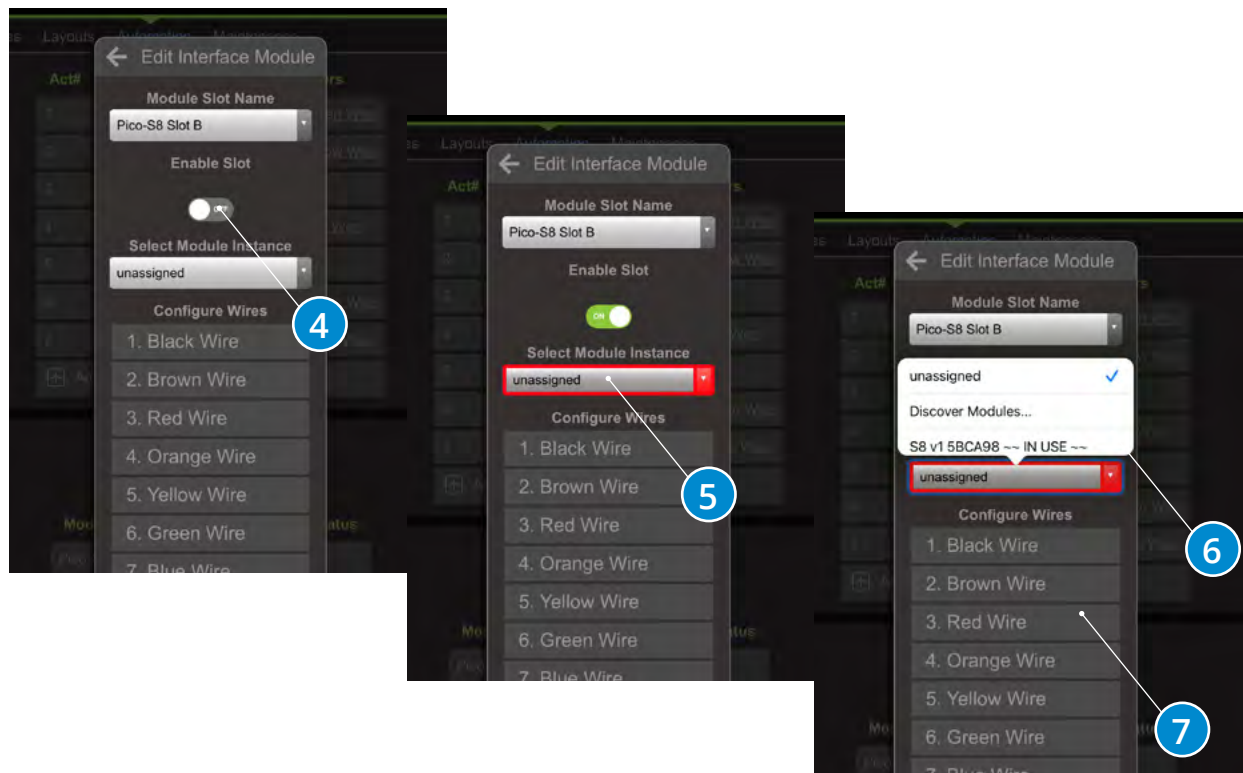

Edit Interface Module Dialog Box:

4. To configure a Pico-S8 slot in the “Edit Interface Module dialog box” toggle “Enable Slot” switch to ON position.
5. Open the “Select Module Instance” dropdown menu and select the entry “Discover Modules” to begin a search for all Pico S8 modules connected to the Poco Accessory Bus (blue wire).
6. Open the dropdown menu again and select one of the discovered modules to assign it to the slot. The slot is configured by default for 8 momentary switches with illumination.
7. **Optional Step:** To change the defaults select an entry in the “Configure Wires” table.

Within the Edit Wire dialog, you can:

- Rename the wire.
- Select the Input Signal Type as Momentary (Push-Button), Latching (Toggle), or No Input (to use wire as illumination output only).
- Select the Output Signal Type as Normal (State), or No Output (to use wire as input-only, i.e. with a latching switch or 3rd-party system).

Automation

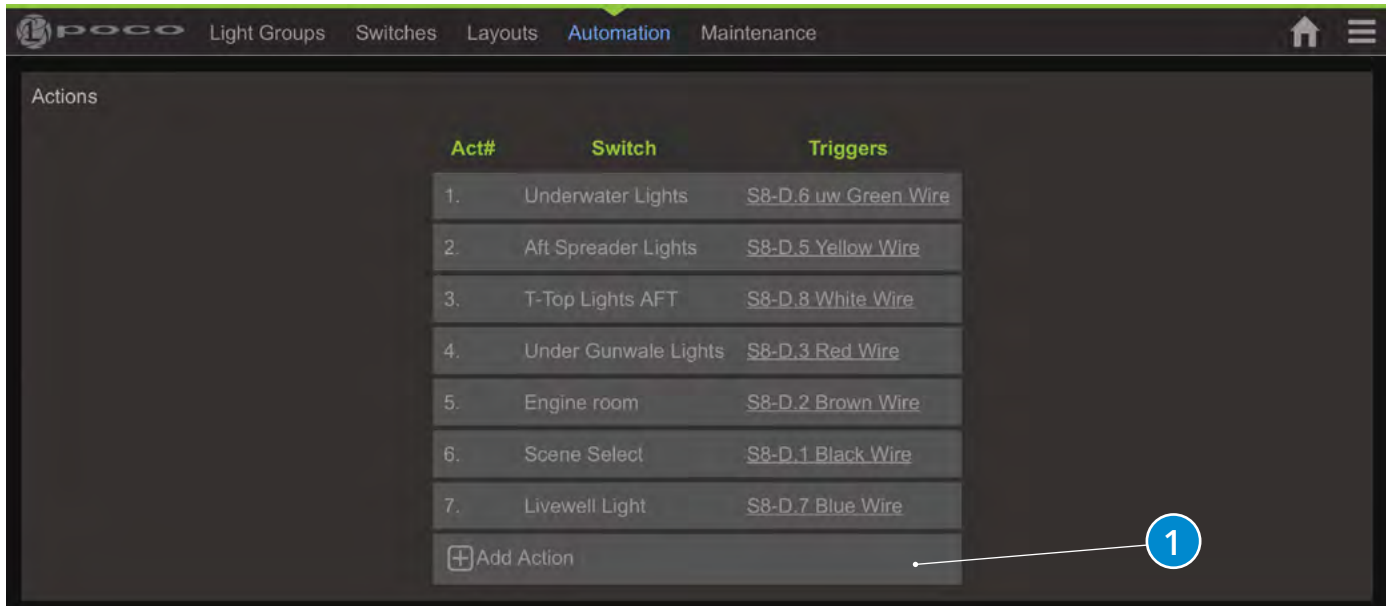

Creating Actions:

An “Action” assigns one or more of the wires that are connected to physical switches to an existing Poco virtual switch. An Action can also select the single Blue Wire on poco if no Pico S8 modules are used.

1. To add an “Action” go to the Actions section of the Automation tab and select “Add Action”. This will open the “Edit Action” dialog box.
2. Select an existing switch from the “Switch” dropdown menu to assign an action. *Note: The Action number is determined by the Poco External-Switch API and can't be modified (for reference only).*
3. Select “Add Trigger” to assign one or more Pico S8 colored wires to this action. Select a wire in the pop-up list. When using a latching mechanical switch with illumination, two triggers will be required to be assigned to each action (one for input-only and one for output-only).

Your physical switch will now activate the Poco Virtual Switch, and the illumination state will be synchronized with the on-screen switch.

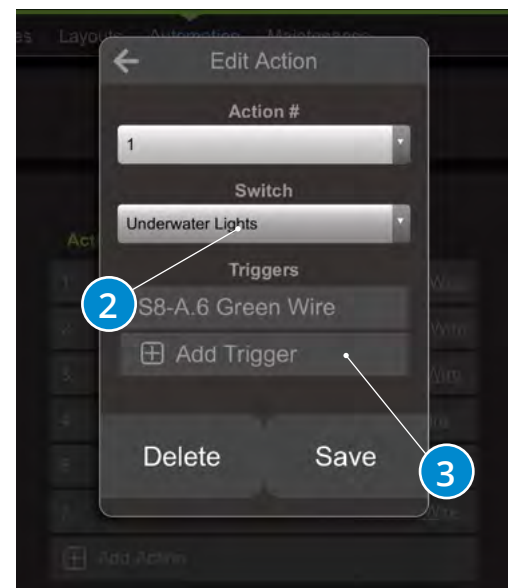

Default Maintenance pin is set to "0000". This can be changed but must be done by manually editing the configuration file. See exporting and importing configuration below.

Maintenance

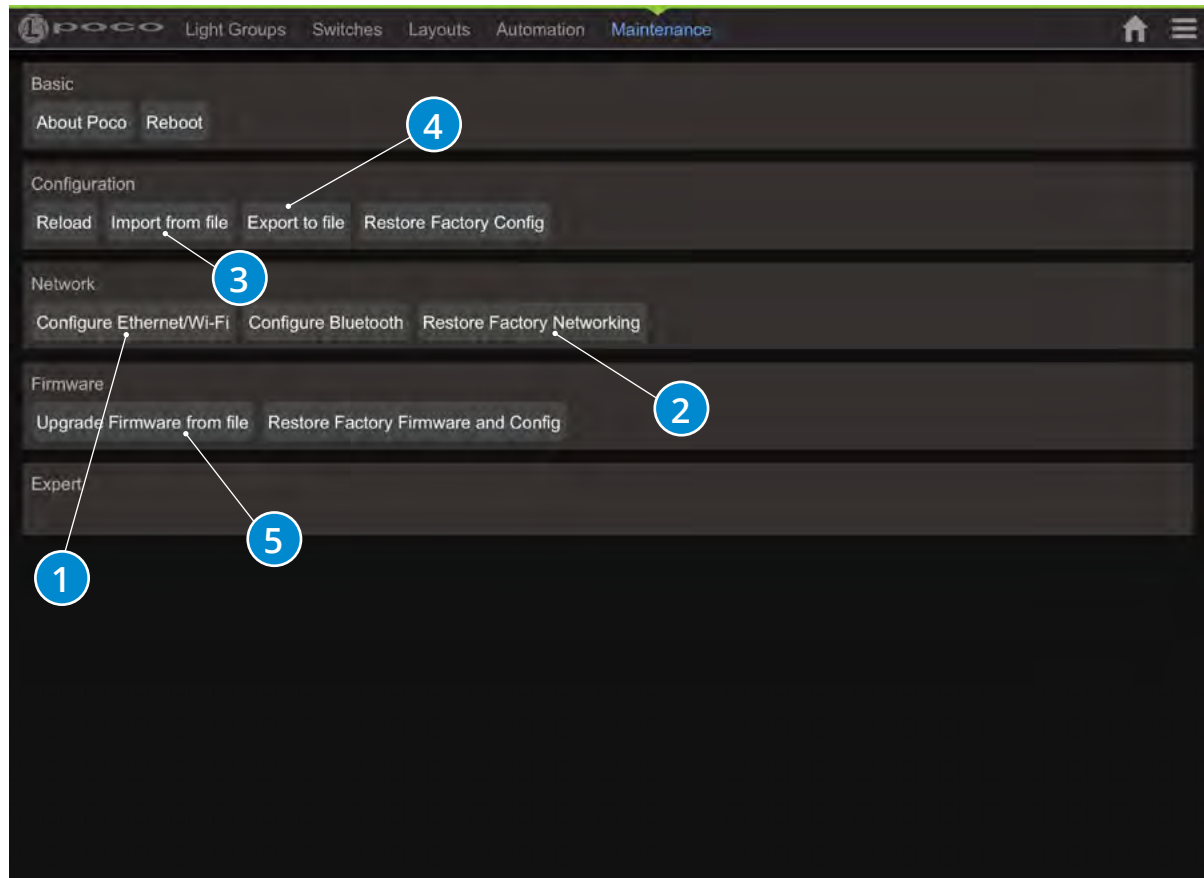

Maintenance Options:

1. By default POCO broadcasts as a WiFi access point (AP). The SSID is "poco-xxxx" where xxxx is a unique ID that is hardware dependent. The WiFi password is located on the back of your POCO device. Or, you can simply scan the QR code on the POCO unit which will populate the POCO ID and WiFi password into your mobile device. NOTE: You may need to turn off cellular data service prior to connecting to POCO via WiFi. IP address for connecting to poco (AP) is 192.168.4.1 (some devices may support accessing poco via http://poco.local). WiFi can be disabled here. Connection can also be configured for connecting POCO to existing WiFi network (STA mode).
2. Restores networking settings to factory default.
3. Import Config file. File type must be .json
4. Export current config file. This is a good way to backup and/or copy this configuration to another unit. You will receive a pop up menu to confirm download, select "OK" to start download.
5. Upgrade POCO Firmware using a xxx_ota.bin file supplied by Lumitec.

NETWORK

Network Setup

As a WiFi access point

The Poco by default serves as a WiFi access point (AP). This connection is good for updating firmware and importing and exporting configuration file as well as testing and configuration. The SSID is "poco-xxxx" where xxxx is a unique ID that is hardware dependent. Default password is located on the back of your Poco device. WiFi settings can be customized/disabled under the Ethernet/WiFi configuration on the maintenance page. WiFi IP address for connecting to server is 192.168.4.1 (some devices may support http://poco.local).

Connecting to an existing access point

The wireless connection can also be configured for connecting Poco to existing WiFi network on the Ethernet/WiFi configuration page. IP address given will depend on DHCP server and can be determined from Access point connection status page.

Bluetooth

Poco is compatible with Bluetooth 4.0 or greater and supported Android and iOS devices with an application downloadable from Apple App Store or Google Play Store.

[Download for Apple](#)

[Download for Android](#)

Wired Network

In order to use the 10/100 Base T network connection for communicating, the POCO device must be connected with a standard Ethernet cable (not included) to a device . If all network ports are used for other system components, a network switch must be used to split the network traffic between two or more networked devices.

UPDATES

Updating Firmware

Firmware update must be completed with a WiFi or Ethernet connection from a device that contains the firmware file. Contact Lumitec for latest firmware file or download form Lumitec website. The device used for update can be a computer, tablet or phone with Chrome, Firefox or Safari browsers. Standard MFDs do not have the ability to perform this upgrade.

- Open a Chrome, Firefox or Safari browser and navigate to IP address 192.168.4.1 for connecting to poco (AP) (some devices may support accessing poco via <http://poco.local>).
- To access the settings menu select the Hamburger Menu icon in upper right of screen (#1).
- Default maintenance pin is set to "0000".
- Select "Upgrade Firmware from File" under the Maintenance / Users page within the configuration of Poco (#2).

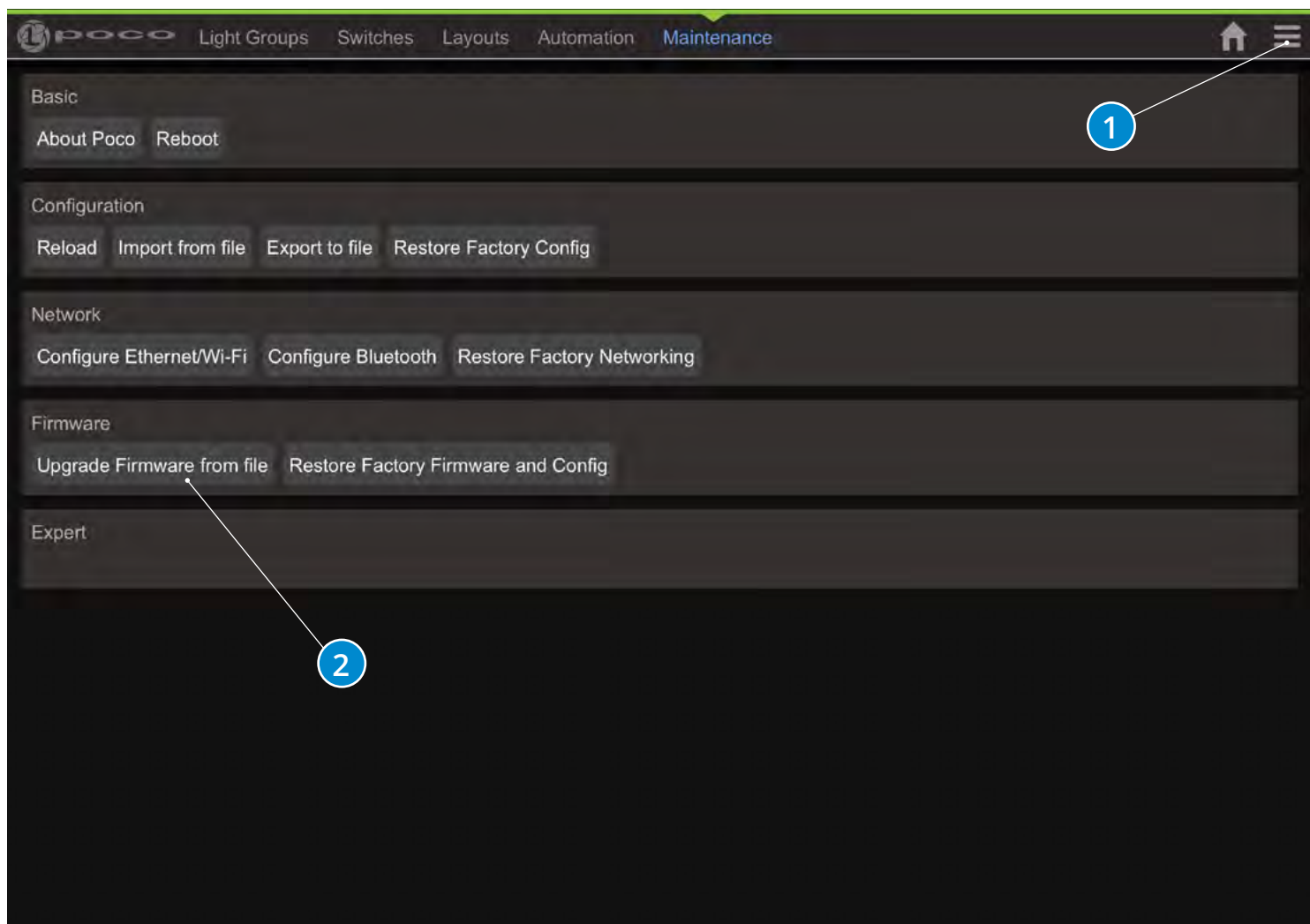

Firmware Update Page

Select "Choose File" (#1) and navigate to the location containing the new firmware file. The file naming format will be similar to "poco-esp32-ota_XXX-XXXX.bin". The Poco contains 3 file system partitions. The first is the original file shipped with Poco under the "factory" partition. Holding the reset button while powering on will default to this partition. The firmware upgrade can go on either ota_1 or ota_2.

Select "Upload to "ota_x" (#2) and apply reboot once upload has been completed. In the example below this Poco is running off of ota_0 and the upgrade would need to be applied to "ota_1". Reboot to complete the upgrade process.

To determine our current version of Poco, click on the Hamburger Menu icon in the top right of the app screen and select "About Poco". The Poco firmware version is listed under "Firmware Version".

For more information watch the Poco firmware update video on our Youtube page. [Watch Video](#)

Upgrade Firmware

App Partitions

Partition Name	Partition Size	App Version	App Valid	App Running	App Set Boot	App Upload
factory	4.000 MiB	TEST27x-2010051602	Verify factory!		Set Boot factory!	Choose File no file selected
ota_0	4.063 MiB	3.1-rc1-2104141849	Verify ota_0!	✓	✓	
ota_1	4.063 MiB	3.0-rc2-2103302035	Verify ota_1!		Set Boot ota_1!	Upload to ota_1!

Data Partitions

Partition Name	Partition Size	Data Type	Erase
nvs	16.000 KiB	nvs	Erase nvs!
otadata	8.000 KiB	ota_data	Erase otadata!
phy_init	4.000 KiB	phy_init	
fddata	12.000 KiB	nvs	
internals	3.750 MiB	fat	Erase internals!

Reboot!

Ready.

TROUBLESHOOTING

Troubleshooting

Poco Digital Lighting Controller		
PROBLEM	CAUSE	SOLUTION
No lights on Poco.	Poco is not receiving required power.	<ul style="list-style-type: none"> - Check power for 10-30 VDC. - Check fuse is not blown. - Check GRND wire.
No lights on Channel 1, 2, 3 or 4.	Channel is not receiving power.	<ul style="list-style-type: none"> - Check power for 10-30 VDC. - Check fuse is not blown. - Check GRND wire.
Red light on Channel 1, 2, 3, or 4.	Power is supplied to Channel from fuse/ breaker panel.	Turn a light on that channel off/on. The red light should flash amber and turn green. You will have to create Light Groups and Switches in the configuration menu to test this capability if they are not already configured.
Channel light solid Orange .	Channel dimmed through PWM .	
Channel light flashes Orange .	Poco Data is being transmitted .	
Status light on Poco not blinking or Aqua.	Poco may be frozen due to a corrupted configuration or firmware update.	Poco factory reset needed. See reset modes section in manual.

Multi-Functional Display (MFD)		
PROBLEM	CAUSE	SOLUTION
MFD Not displaying Poco icon	Check ethernet connection between Poco & MFD. A flashing green light on Ethernet cable indicates data is being transmitted from Poco to the MFD.	<ul style="list-style-type: none"> Ensure MFD Ethernet port is working. Change Ethernet to a known working port Update MFD to latest version of firmware.

TROUBLESHOOTING

continued...

Troubleshooting

Pico S8 Module		
PROBLEM	CAUSE	SOLUTION
Solid Green status light.	Pico S8 is powered and enabled within Poco.	No action needed.
No Indicator Light on S8.	Check 10-30 VDC is supplied to red wire and ground wire connected.	<ul style="list-style-type: none"> - Check power for 10-30 VDC. - Check fuse is not broken. - Check GRND wire .
Solid red light on Pico S8.	Pico S8 has power but is not communicating with Poco. Poco may not be powered or is not configured for Pico S8.	Refer to Pico S8 installation guide in manual.
Flashing Red status light.	Pico S8 not assigned to a slot in Poco.	Refer to Pico S8 installation guide in manual.

Physical Switch		
PROBLEM	CAUSE	SOLUTION
Physical switch not activating Poco Virtual Switch.	<ul style="list-style-type: none"> - Check Status light on Pico S8. Light should be Green. - Check if corresponding virtual switch within Poco App (on mobile device or MFD) is turning on/off. - Check color wire going to S8 . 	<p>See Pico S8 trouble shooting section.</p> <p>Verify Action/Trigger in Automation section.</p>
Physical switch not illuminating.	Does the switch illuminate momentarily when Poco is booting up?	<p>Yes - Check configuration is set to "Normal (State)" Output Signal Type.</p> <p>Yes - Check wire is assigned an Action, and/or Poco Virtual Switch.</p> <p>No- Check wiring for reverse-polarity.</p> <p>No - Check S8 and physical switches are connected to the same power-supply.</p>

Additional Resources

[Watch Training Videos >](#)

[Download Poco App For Apple >](#)

[Download Poco App For Android >](#)

[Visit Lumitec Website >](#)



Glossary

Term	Descriptions
MFD	Multifunction Display. Typically a touch screen with graphical user interface connected to various vessel sensors and hardware.
PLI	Power Line Instruction - Digital data sent from POCO over power wires to Lumitec lights to control color, intensity and displayed patterns.
PWM	Pulse Width Modulation - Used to control the intensity of Non-PLI enabled lighting through the control of the power duty cycle.
UI	User Interface typically displayed on MFD or other portable connected devices.
TTP	Time Toggle Protocol - Lumitec's proprietary technology allowing for user selectable light modes within a light by toggling a standard toggle switch.
Channel (CH)	One of (4) outputs on the switch hardware module.
Device	A single specific light or other accessory.
Clan	A PLI-level identifier for one or more devices. Clans are roughly organized around product families. See User Interface Setup for list of Clans.
Light Group	A single Device or multiple Devices defined by Clan & Channel for PLI lights or a Channel if the light group is a PWM dimmable of standard ON/OFF device.
Spectrum	Mode built into some Lumitec Lights that is a continuous changing of light hues (starts with blue light, transitions to red, then transitions to green and then transitions back to blue over a 3 minute time period) Omnillume Switch User interface switch that has the ability to modify color and brightness for the lights that are attached to it with a press and hold action.
Scene	A set of commands sent to multiple light groups to create a custom lighting environment. Commands may include Intensity, Color, ON/OFF State, Etc.

