

Loop Top Height 630 (25")

*Specified finishes
relate to colour only
and not material.*



27013
Black & Brass



27077
Black & Antique



27006
All Antique



27023
All Black



27008
Black & Chrome



27127
All Pewter



27101
Black & Pewter



Ball Top Height 590 (23")



27112
Black & Pewter

27128
All Pewter

27111
Black & Brass

27113
Black & Antique

27094
All Black

Specified finishes relate to colour only and not material.

Traditional Top - 3 Legged Base Height 600 (24")



27088
All Black

4

27096
All Pewter

Traditional Top - Round Base Height 406 (16")



27114
Black & Brass



27116
Black & Antique



27115
Black & Pewter



27095
All Black



Specified finishes relate to colour only and not material.

Traditional Top - Round Base Height 570 (22.5")



27110
Black & Brass



27108
All Black



CALFIRE Companion Sets

Acorn - Height 540 (21")



27017
All Black

27117
Black & Pewter

27031
Black & Brass

27030
Black & Antique

Specified finishes relate to colour only and not material.

Spiral - Height 610 (24")

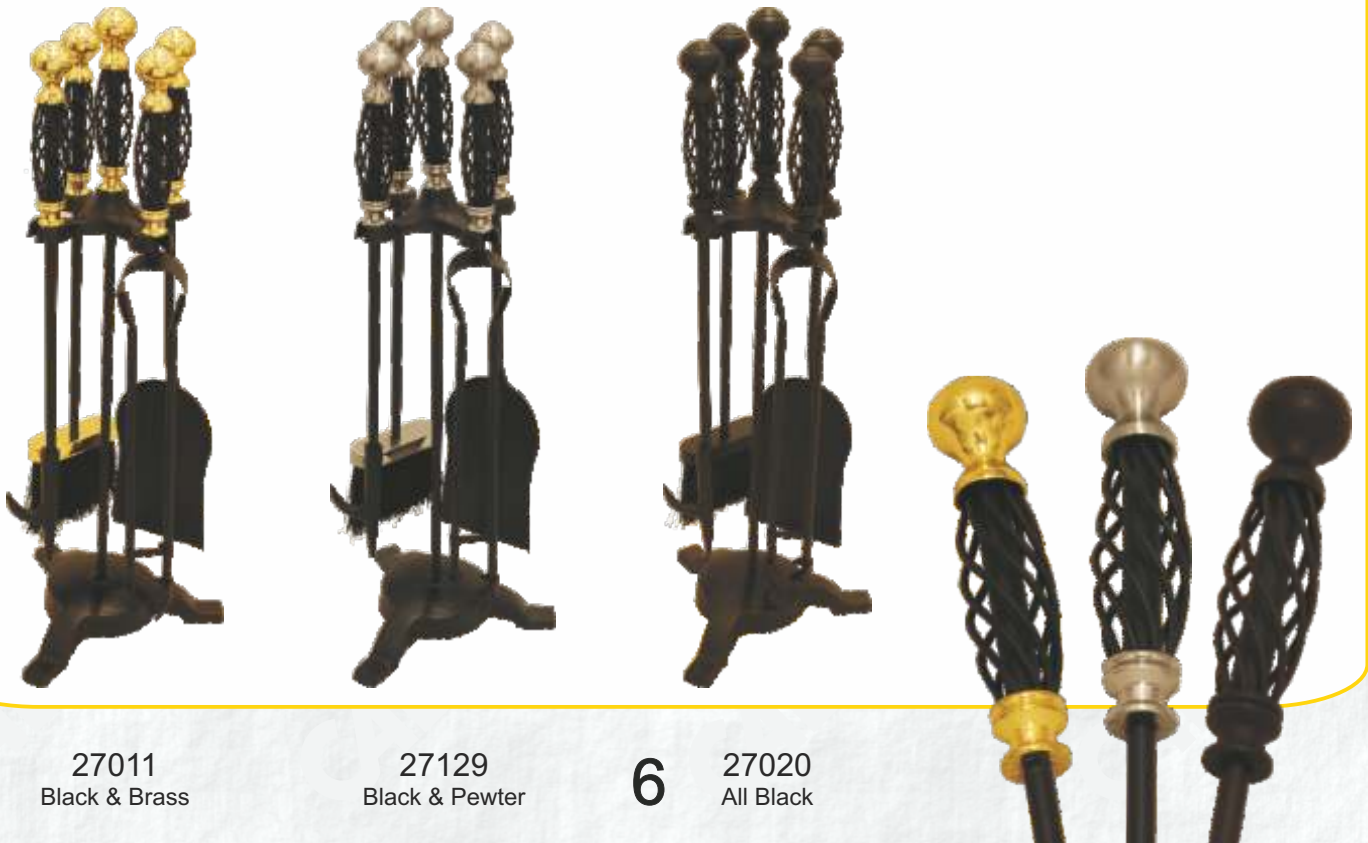

27011
Black & Brass

27129
Black & Pewter

6

27020
All Black

Specified finishes relate to colour only and not material.

Cage Height 685 (27")



27104
All Black



Gallery Height 590 (23")



27102
Black & Pewter



27005
Black & Antique



27019
All Black



27010
Black & Brass

Basket - Height 410 (16")

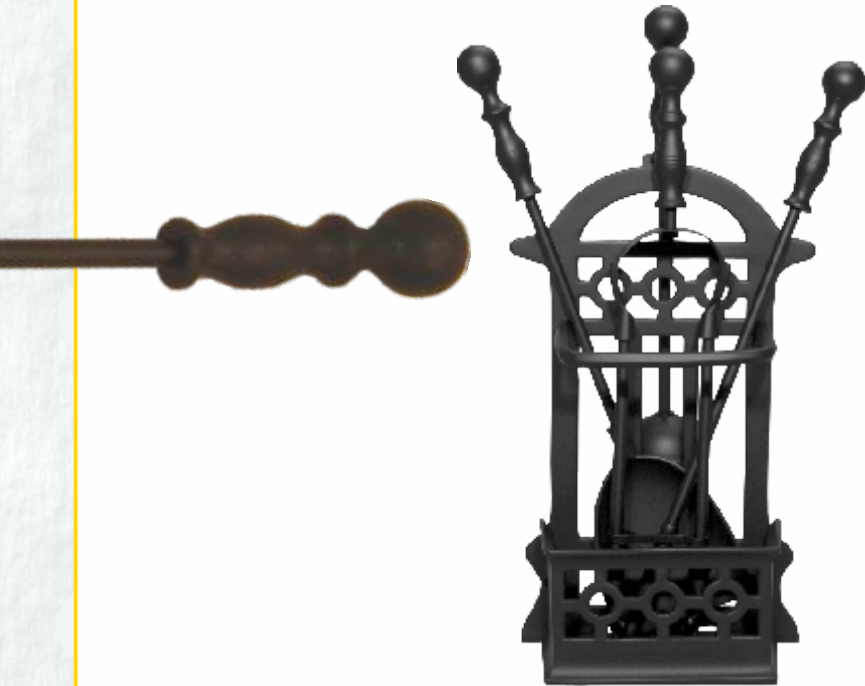

27057
All Black

Specified finishes relate to colour only and not material.

Pyramid - Height 660 (26")



27133
All Pewter

27132
All Black

8

Hordley - Height 605 (24")



27131
All Pewter

27130
All Black

Duchess

Heights 400 & 480 (16 & 19")



27085 16"
27086 19"
Black & Solid Brass



27123 16"
27124 19"
Black & Antique Brass EP



27118 16"
27119 19"
Black & Pewter



27043 16"
27045 19"
All Black

Specified finishes relate to colour only and not material.

Regency

Rope Twist

Open Twist

Specified finishes relate to colour only and not material.



27078
All Black
H 470 (18")



27041
All Black
H 650 (26")

Supplied with Log & Coal Tongs with Poker in centre.



27048
All Black
H 515 (20")

Worthen



27037
All Black
H 640 (25")

Weston



27141
All Black
H 710 (28")

Shepherds
Crook



27144
All Black
H 710 (28")

Iron
Gate



27145
All Black
H 735 (29")

The Iron Gate Fireset matches the Iron Gate firescreen shown on page 23.

Specified finishes relate to colour only and not material.

Vintage



27139
All Black
H 700 (27.5")

Craftsman



27140
All Black
H 760 (30")

Diamond



27143
All Black
H 760 (30")

The Diamond Fireset matches the Diamond firescreens shown on page 22.

Basic



27138
All Black
H 700 (27.5")

The Basic Fireset is part of a set of 'basic' products that are available. Also see the 'basic' firescreen on page 22 and the 'basic' log carrier on page 39.

Rushton



27054
All Black
H 635 (25")

Petton



27137
All Black
H 605 (24")

Tilley



27135
All Black
H 665 (26")

Wood
Stove



27142
All Black
H 535 (21")

Specified finishes relate to colour only and not material.

Forged



27134
All Black
H 685 (27")

Pony



27125
All Black
H 520 (21")

Cast



27018
All Black
H 520 (20.5")

Malmo



27146
All Black
H 665 (26")
See matching Log
Holder on Page 40

Modern
Ball



27064
All Black
H 465 (18")

Modern
Round



27092
All Black
H 580 (23")

Ercall



27097
All Black
H 610 (24")

Specified finishes relate to colour only and not material.

Fleur-de-lys

H 520 (20.5")



27106
Brushed Steel

27105
All Black



Knight

27120
Silver Black
H 740 (29")

Bellows



Made from Sheesham Wood, Leather & Solid Brass.
Sheesham is a heavy hardwood with a rich chestnut colour.

29069
Carved Hardwood Bellows
Length 470 (18.5")

29080
Plain Hardwood Bellows
Length 355 (14")

29015
Fleur-de-lys Hardwood Bellows
Length 470 (18.5")



Ornamental use only

29012
Oak
Length 380 (15")



Ornamental use only

29016
Wood
Length 420 (16")

Hearth Tidies



Length 340 (13")

29019
Black
Large Ball

*Specified finishes
relate to colour only
and not material.*



Length 380 (15")

29066
Black Traditional

29075
Black & Brass



Length 300 (12")

29003
Black
Cast

29064
Black &
Brass Cast

29081
Black &
Pewter Cast



Length 380 (15")

29071
Black
Loop

29072
Black &
Brass Loop

29082
Black &
Pewter Loop

CALFIRE Fireside Accessories

Match Holders & Matches

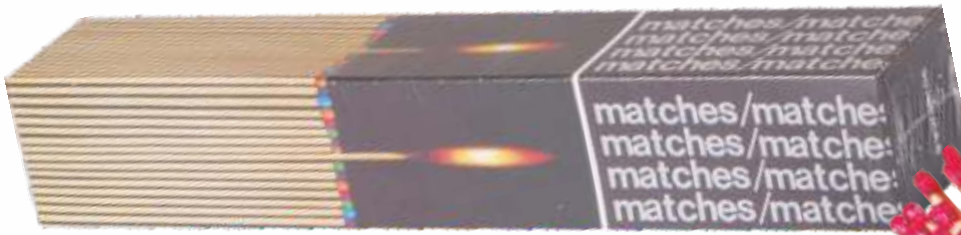

90 matches per box

29005
Long Matches L280 (11")



Holder H200 (8")
[Excluding Matches]



29055
All Black



29004
Brass & Copper



29077
Satin & Polished Steel

Brush Refills



28031 Round Brush
(British) 50mm Ø



29070 - 50mm Ø
Round Brush (Chinese)
29046 - 46mm Ø
Round Brush (Indian)
29056 - 40mm Ø
Small Round Brush
(Indian 16"
Companion Sets)



29009
Oblong Brush
100x28mm



29079
Straw
Brush
(Chinese)

Coal & Log Tongs



29008 - Black Cast Coal Tongs
Size L350mm (14")



29060 - Solid Brass Coal Tongs
Size L265mm (10")



29062 - Black Coal Tongs
Size L265mm (10")



29063
Black Log
Tongs Size
L390mm
(15")

Shovels

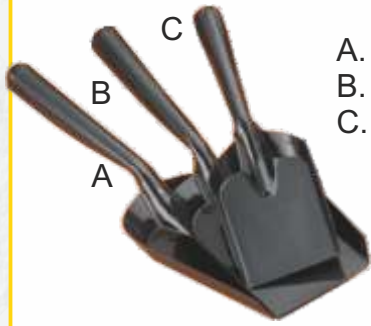

A. 28040 6" Steel Shovel
B. 28039 5" Steel Shovel
C. 28038 4" Steel Shovel



D. 28042 9x7" Shovel
E. 28043 10x8" Shovel



28044
10x8" Galv Shovel



29050
Small Shovel
Length 305 (12")

29048
Large Shovel
Length 350 (14")

Individual Tools

A5 Poker



28045 - L560 (22")

A5 Collins Tongs

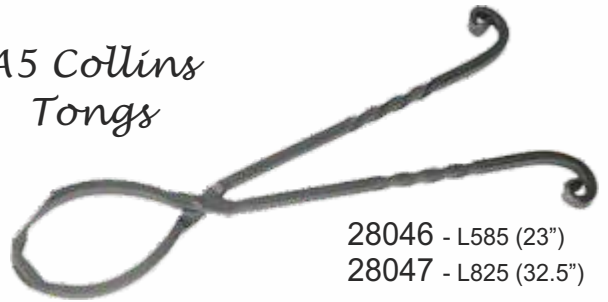

28046 - L585 (23")
28047 - L825 (32.5")

A7 Toasting Fork

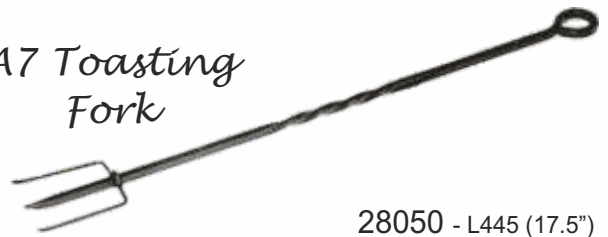

28050 - L445 (17.5")

A8 Log Roller

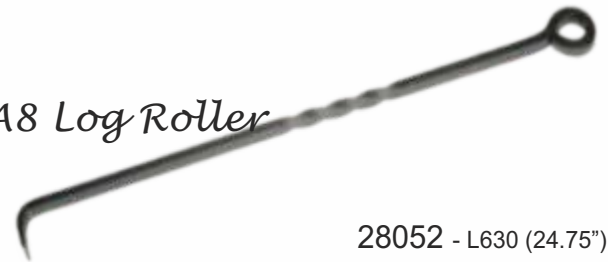

28052 - L630 (24.75")

A9R log Roller



28055 - L770 (30")
28056 - L1065 (42")



Individual Tools

Ring Top Tools - Length 450 (18")

Hangers

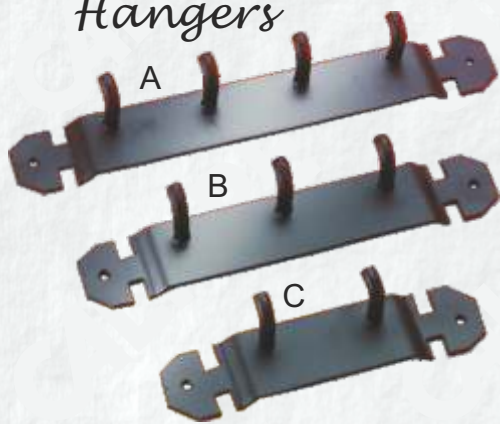

- | | | |
|-------------------------|------------------------|------------------------|
| A | B | C |
| 29054 | 29053 | 29052 |
| 4 Position
L265(10") | 3 Position
L220(9") | 2 Position
L160(6") |



Toasting Fork recommended only for Ornamental use.

- | | | | | | |
|------------------|---------------|--------|-------|---------------|-------|
| 29083 | 29084 | 29085 | 29086 | 29087 | 29088 |
| Toasting
Fork | Coal
Tongs | Shovel | Brush | Log
Roller | Poker |

Loop Top Tools - Length 450 (18")

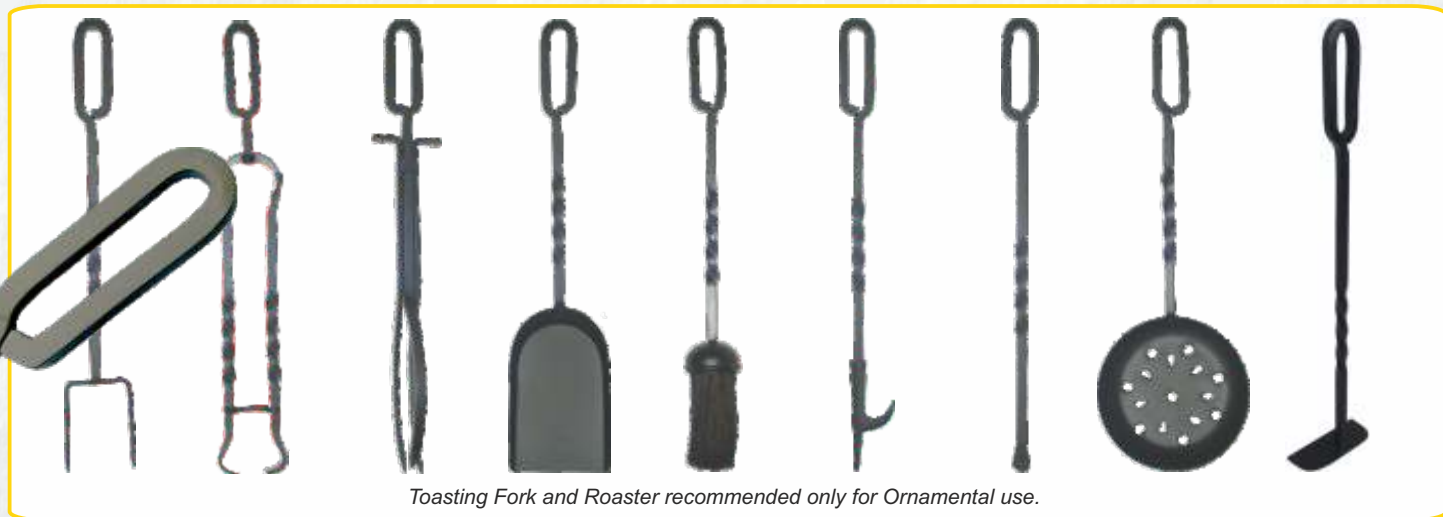

Toasting Fork and Roaster recommended only for Ornamental use.

- | | | | | | | | | |
|------------------|---------------|--------------|--------|-------|---------------|-------|---------|----------------|
| 29030 | 29031 | 29032 | 29033 | 29034 | 29035 | 29036 | 29037 | 29089 |
| Toasting
Fork | Coal
Tongs | Log
Tongs | Shovel | Brush | Log
Roller | Poker | Roaster | Ash
Scraper |

Rope Twist Tools - Length 450 (18")

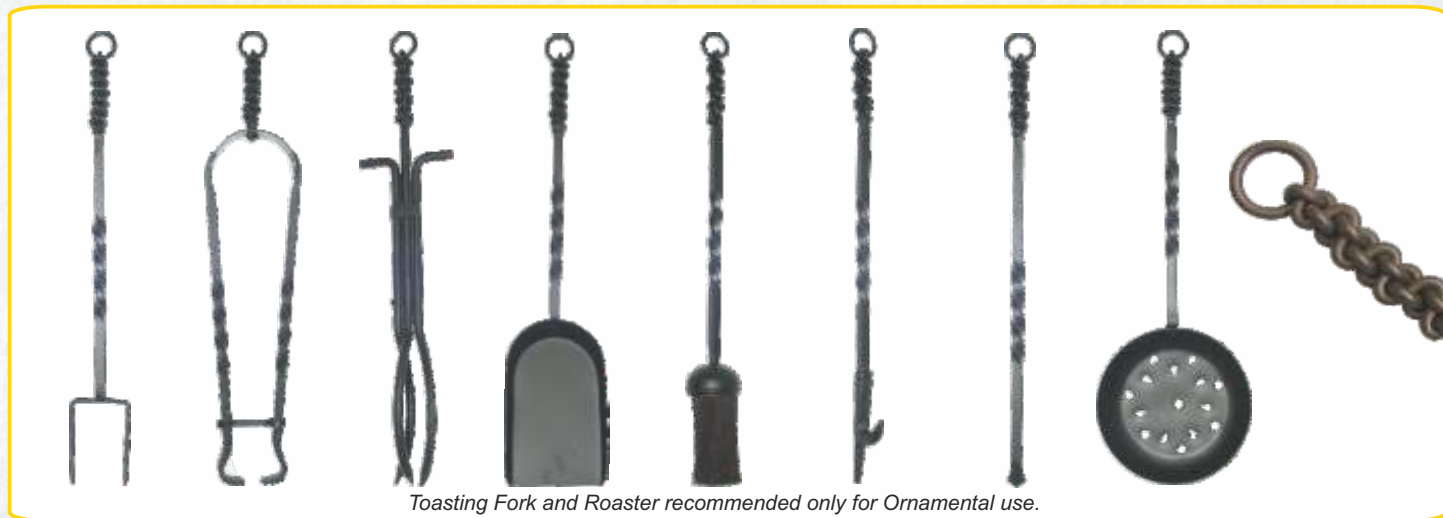

Toasting Fork and Roaster recommended only for Ornamental use.

- | | | | | | | | |
|------------------|---------------|--------------|--------|-------------|---------------|-------|---------|
| 29038 | 29039 | 29040 | 29041 | 29042-Brush | 29043 | 29044 | 29045 |
| Toasting
Fork | Coal
Tongs | Log
Tongs | Shovel | Brush | Log
Roller | Poker | Roaster |

Pokers & Poker Sets



29067
Poker & Ash Scraper Set. L610 (24"); Black



29065
Black Victorian Poker L 700 (28")



29021
Black Poker & Stand H 580 (23")



29076
Sets of 5 various Pokers. L760 (30")

4 Fold



Pewter



Black



- 21047 - H640 Panels200 (25x8")
- 21076 - H710 Panels315 (28x12")
- 21077 - H820 Panels315 (32x12")

Specified finishes relate to colour only and not material.

- 21027 - H540 Panels200 (21x8")
- 21028 - H640 Panels200 (25x8")
- 21029 - H710 Panels315 (28x12")
- 21026 - H820 Panels315 (32x12")

Brass



Antique



- 21014 - H640 Panels200 (25x8")
- 21012 - H710 Panels315 (28x12")
- 21011 - H820 Panels315 (32x12")

- 21022 - H640 Panels200 (25x8")
- 21020 - H710 Panels315 (28x12")
- 21019 - H820 Panels315 (32x12")

CALFIRE Fire Screens

3 Fold

CALFIRE
The Fireside Collection



Black



21030 - H680 W430 Wings210 (26.75x17x8")
21025 - H720 W610 Wings280 (28.25x24x11")

Pewter



21048 - H680 W430 Wings210 (26.75x17x8")
21078 - H720 W610 Wings280 (28.25x24x11")

***Specified finishes
relate to colour only
and not material.***

Antique



21024 - H680 W430 Wings210 (26.75x17x8")
21021 - H720 W610 Wings280 (28.25x24x11")

Brass



21015 - H680 W430 Wings210 (26.75x17x8")
21010 - H720 W610 Wings280 (28.25x24x11")

CALFIRE Fire Screens 3 Fold

Black Plain & Decorative Wrought



Black 21049
H580 W450 Wings210
(23x18x8")



Black 21050
H580 W450 Wings210
(23x18x8")



Black 21059
H710 W450 Wings210
(28x18x8")



Black 21060
H710 W450 Wings210
(28x18x8")

Steel Plain & Decorative Wrought



Steel 21061
H580 W450 Wings210
(23x18x8")



Steel 21062
H580 W450 Wings210
(23x18x8")



Steel 21088
H710 W450 Wings210
(28x18x8")



Steel 21089
H710 W450 Wings210
(28x18x8")

CALFIRE The Fireside Collection

The design of this range of screens is changing from being manufactured with a 7mm square bar to using 16mm x 8mm box section. Screen supplies will depend on stock availability.

Bronze Plain & Decorative Wrought



Bronze 21102
H580 W450 Wings210
(23x18x8")



Bronze 21101
H580 W450 Wings210
(23x18x8")



Bronze 21103
H710 W450 Wings210
(28x18x8")

3 Fold

CALFIRE
The Fireside Collection



Arched

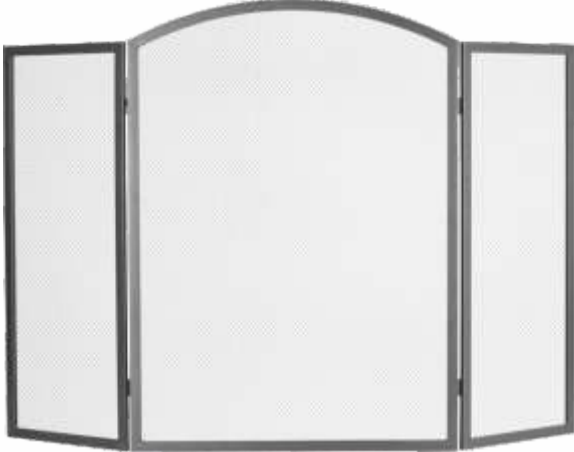

Black 21098 H635 W530 Wings230 (25x21x9")
Black 21099 H710 W610 Wings280 (28x24x11")

Basic



Black 21096 H635 W530 Wings230 (25x21x9")
Black 21097 H710 W610 Wings280 (28x24x11")

Diamond



See matching companion set on page 10.

Black 21094
H710 W610 Wings280
(28x24x11")

Medallion

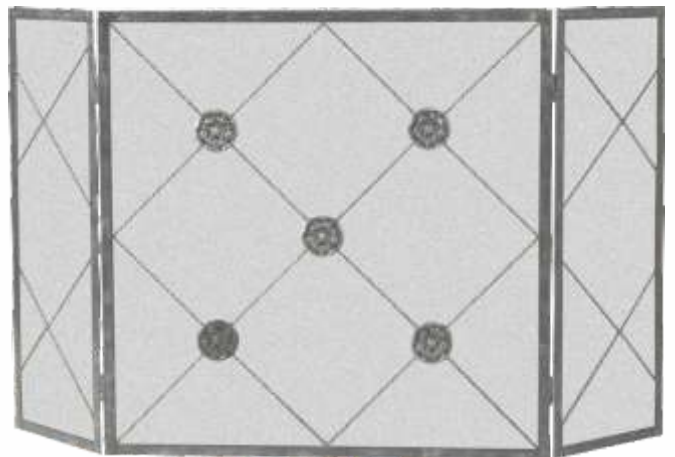

Black 21095
H710 W610 Wings280
(28x24x11")

CALFIRE Fire Screens

Single Panel

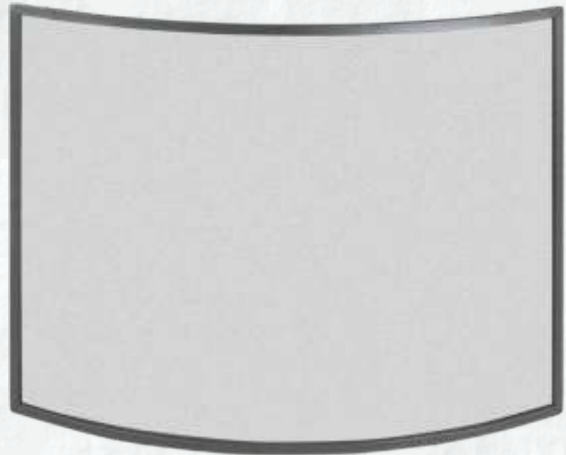

CALFIRE
The Fireside Collection

Plain Flat

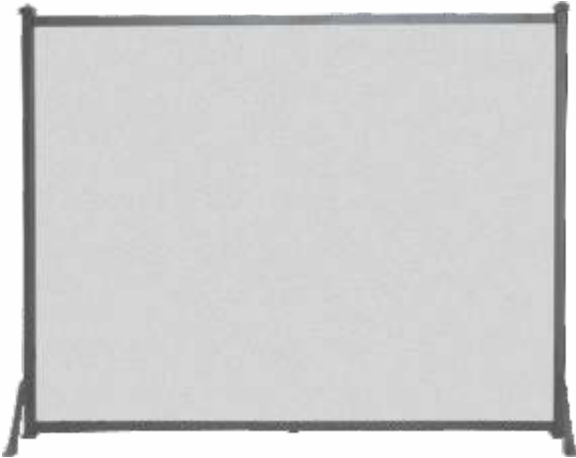

Black 21092 H610 W660 (24x26")
Black 21093 H710 W760 (28x30")

Narrow Curved

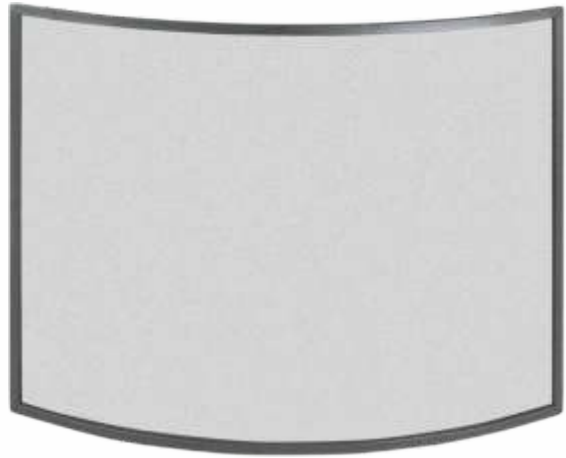

Black 21090 H610 W660 D70 (24x26x2.75")
Black 21091 H710 W760 D95 (28x30x3.75")

Specified finishes relate to colour only and not material.

Iron Gate



See matching companion set on page 10.

Black 21100
H710 W760
(28x30")

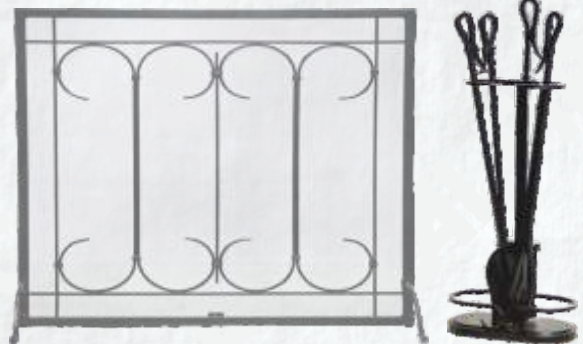



The Noble Collection

Flat

Alum Trim
20057
H610 W610 (24x24")

Brass Trim
20056
H610 W610 (24x24")

Black
20055 H610 W610 (24x24")
20079 H610 W760 (24x30")
20080 H685 W760 (27x30")
20081 H760 W915 (30x36")

Not suitable for fixing kit

Arched Flat

Alum Trim
20021
H610 W610 (24x24")

Brass Trim
20000
H610 W610 (24x24")

Black
20011 H610 W610 (24x24")
20082 H610 W760 (24x30")
20083 H685 W760 (27x30")
20084 H760 W915 (30x36")

Not suitable for fixing kit

all items on this page can be made to measure

All NOBLE firescreens can be 'made to measure' with your height, width and, if relevant, depth dimensions. Call for details. Heights given for firescreens exclude handles.

Flat Fan

Not suitable for fixing kit

Black 20069
H620 W770 (24.5x30")

Flat Sided Bowed

Not suitable for fixing kit

Black 20068
H610 W795 D185 (24x31x7.25")

ALL BRITISH MADE ITEMS ON THIS PAGE



The Noble Collection



Alum Trim
20026
H610 W585 D150
(24x23x6")

Wedge



Brass Trim
20005
H610 W585 D150
(24x23x6")

Brass Trim



Black
20016
H610 W585 D150
(24x23x6")

Black



Alum Trim
20025
H610 W585 D75
(24x23x3")

Curved



Brass Trim
20004
H610 W585 D75
(24x23x3")

Brass Trim



Black
20015
H610 W585 D75
(24x23x3")

Black

all items
on this page
can be made
to measure

Fixing kit 21500 available separately; see page 30 for details.

Not suitable for fixing kit

All NOBLE firescreens can be 'made to measure' with your height, width and, if relevant, depth dimensions. Call for details.
Heights given for firescreens exclude handles.

Curved Delux





Not suitable for fixing kit

Brass Trim 20010
H610 W585 D75
(24x23x3")

Alum Trim 20031
H610 W585 D75
(24x23x3")





The Noble Collection

Box Closed



Alum Trim

20028
H610 W640 D230
(24x25x9")



Brass Trim

20007
H610 W640 D230
(24x25x9")



Black

20018
H610 W640 D230
(24x25x9")

Box Open



Alum Trim

20027
H610 W640 D230
(24x25x9")



Brass Trim

20006
H610 W640 D230
(24x25x9")



Black

20017
H610 W640 D230
(24x25x9")



Fixing kit 21500 available separately; see page 30 for details.

Fixing kit 21500 available separately; see page 30 for details.

All NOBLE firescreens can be 'made to measure' with your height, width and, if relevant, depth dimensions. Call for details.
Heights given for firescreens exclude handles.

Sloping Box - H690 W610 D205 (27x24x8")



Fixing kit 21500 available separately; see page 30 for details.

Black 20061

Brass Trim 20062

Alum Trim 20063





The Noble Collection

Double Rail
Box Open

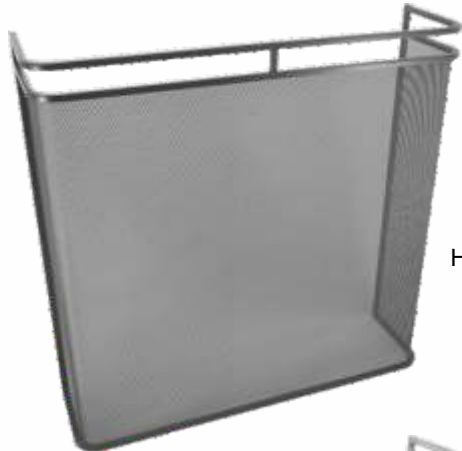

Black
20092
H650 W660 D175
(25.5x26x7")



Steel Clear
Lacquer Finish
20093
H650 W660 D175
(25.5x26x7")

Double Rail
Fender Guard

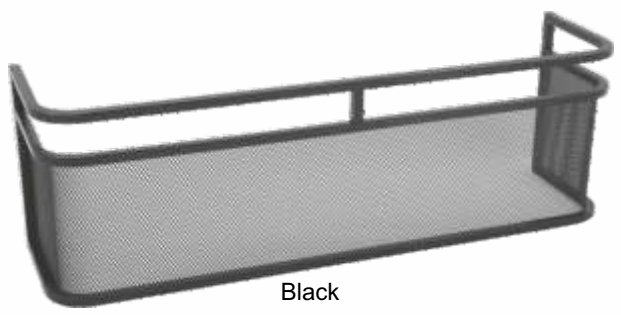

Black
20094
H200 W610 D150
(8x24x6")

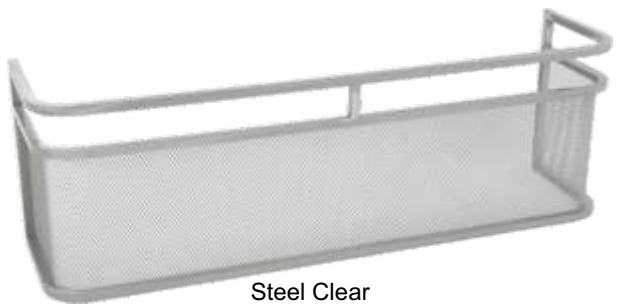

Steel Clear
Lacquer Finish
20095
H200 W610 D150
(8x24x6")



all items
on this page
can be made
to measure

Fixing kit 21500 available separately; see page 30 for details.

Fixing kit 21500 available separately; see page 30 for details.

All NOBLE firescreens can be 'made to measure' with your height, width and, if relevant, depth dimensions. Call for details. Heights given for firescreens exclude handles.

Arched Box



Fixing kit 21500 available separately; see page 30 for details.

Black 20067
H715 W585 D155
(28x23x6")

Bent Box



Fixing kit 21500 available separately; see page 30 for details.

Black 20090
H560 W635 D155 (22x25x6")
Black 20078
H610 W660 D155 (24x26x6")
Black 20091
H760 W760 D155 (30x30x6")

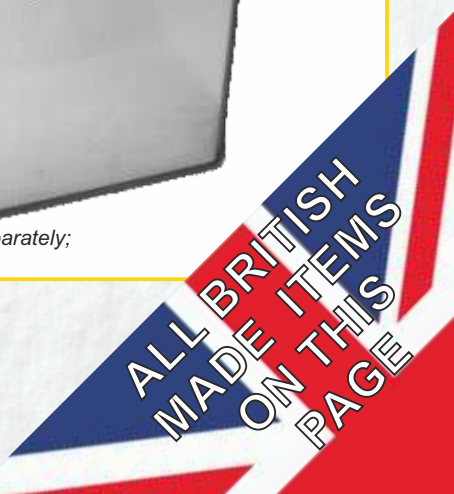



The Noble Collection



Winged

Alum Trim
20030
H610 W610 D200
(24x24x8")



Bent

Alum Trim
20023
H610 W660 D155
(24x26x6")



Brass Trim
20009
H610 W610 D200
(24x24x8")



Brass Trim
20002
H610 W660 D155
(24x26x6")



Black
20085
H585 W455 D200 (23x18x8")
20020
H610 W610 D200 (24x24x8")
20086
H685 W760 D200 (27x30x8")
20087
H760 W915 D200 (30x36x8")



Black
20088
H560 W635 D155 (22x25x6")
20013
H610 W660 D155 (24x26x6")
20089
H760 W760 D155 (30x30x6")

Fixing kit 21500 available separately; see page 30 for details.

Fixing kit 21500 available separately; see page 30 for details.

All NOBLE firescreens can be 'made to measure' with your height, width and, if relevant, depth dimensions. Call for details.
Heights given for firescreens exclude handles.

Arched Bent



Fixing kit 21500 available separately;
see page 30 for details.

Black 20074
H660 W660 D130
(26x26x5")





The Noble Collection



All NOBLE firescreens can be 'made to measure' with your height, width and, if relevant, depth dimensions. Call for details.

Heights given for firescreens exclude handles.

all items on this page can be made to measure

Crescent

H600 W770 D175 (23.5x30x7")



Steel with Black Mesh 20077



All Black 20076

Fixing kit 21500 available separately; see page 30 for details.

Bowed Front



All Steel 20075
H605 W610 D225
(24x24x9")



Alum Trim 20060
H605 W610 D225
(24x24x9")



Brass Trim 20059
H605 W610 D225
(24x24x9")



Black 20058
H605 W610 D225
(24x24x9")

Black 20096
H770 W770 D225
(30x30x9")

Fixing kit 21500 available separately; see page 30 for details.

ALL BRITISH
MADE ITEMS
ON THIS
PAGE



The Noble Collection

Laura (screen with tools)



Not suitable for fixing kit.

Black 20044
H670 W810 D190
(26x32x7")

Heights given for firescreens exclude handles.

All NOBLE firescreens can be 'made to measure' with your height, width and, if relevant, depth dimensions. Call for details.

Noble Screen Fixing Kit



Kit comprises:
2 brackets (left and right hand), 2 fixing bolts & nuts,
2 wall brackets with adhesive pads, 2 wall brackets for drilling,
4 fixing screws & wall plugs.

Suitable for Noble Screens as shown

21500



all items
on this page
can be made
to measure



Heavy Stove Guard

Please note with this guard the depth cannot be greater than the width on any made to measure specials.



Fixing kit 21500 available separately; see page 30 for details.

ALL BRITISH
MADE ITEMS
ON THIS
PAGE

CALFIRE Fire Screens

Spark Guards

Specified finishes
relate to colour only
and not material.



Black & Brass



Black & Brass
20039
H595 W520
(23x20.5")



Black & Brass
20040
H610 W610
(24x24")

Domed Guard



Domed Guard
20051
H600 W555
(23.5x22")



Domed Guard
20054
H530 W485
(21x19")

All Black



All Black
21069
H630 W520
(25x20.5")



All Black
21070
H665 W665
(26x26")

CALFIRE Fire Screens

Nursery Guards Extending Nursery

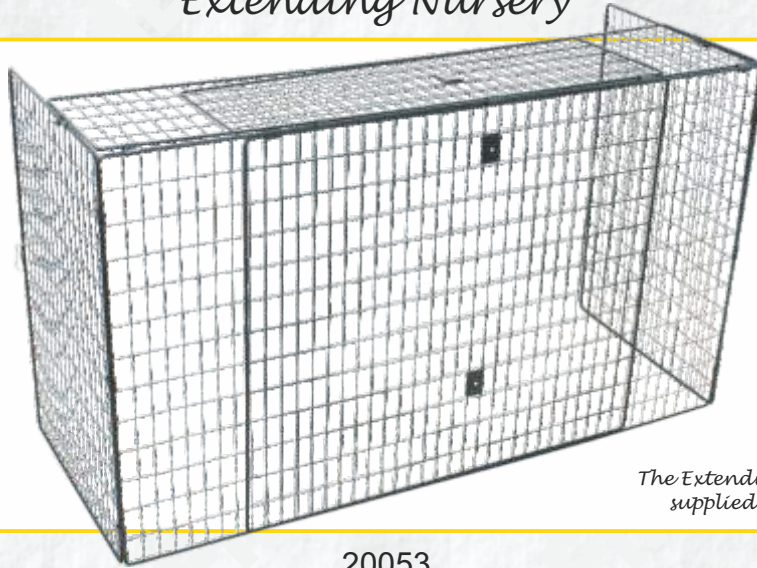

The Extending Nursery Guard is supplied with a fixing kit.

20053

Extending Nursery Guard H670 W900/1525 D455 (26x36/60x18")

Stove Nursery



The Stove Nursery Guard is supplied with a fixing kit.

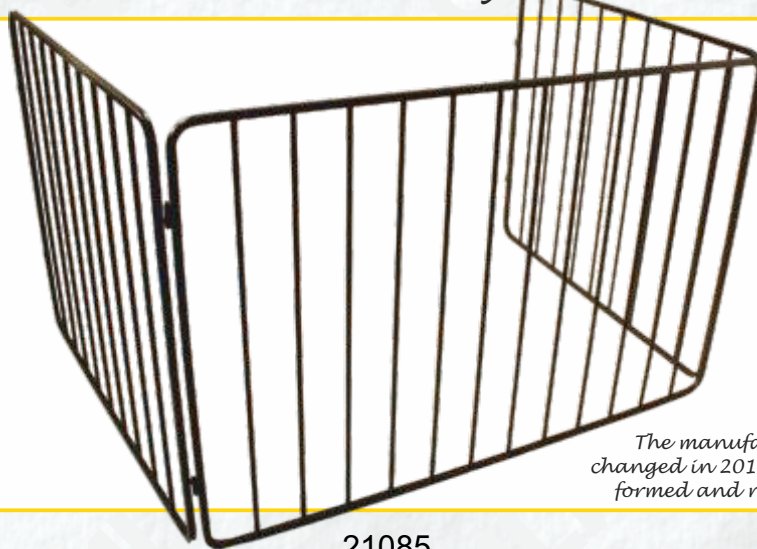

The manufacturing process was changed in 2014 with the corners being formed and not made from plastic.

21085

Stove Nursery Guard H750 W1190 D865 (29.5x47x34")

Bar Nursery



The Bar Nursery Guard is supplied with a fixing kit.



21086

Bar Nursery H750 W1400 D480 (29.5x55x19")

Coal Bucket Sets



All Black 23035
Dia. 240-280
(9.5-11")



Hadley Set(2)

Measurements given for coal buckets and hods exclude their handles.



Kenley Set(2)

Black & Chrome 23042/2
Dia. 270-330
(10.5-13")



Kenley Set(2)

All Black 23015/2
Dia. 270-330
(10.5-13")



Kenley Set(2)

Black & Solid Brass 23007/2
Dia. 270-330
(10.5-13")



Kenley Set(2)

Antique 23079/2
Dia. 270-330
(10.5-13")

Measurements given for coal buckets and hods exclude their handles.

Coal Buckets

Dryton Hod

Height 535 (21")

- A - 23014
Black Dryton Hod
- B - 23033
Zinc Dryton Hod
- C - 23080
Antique
- D - 23034
Copper Bronze Hod



Norfolk Hod - Height 580 (23")



Black & Brass
23073

All Black
23072

Bicton Hod - Height 535 (21")



Black & Brass
22007

Black & Brushed Steel
22112

All Black
22010

Specified finishes relate to colour only and not material.

Kenley Medium - Dia. 270 (10.5")



23015M
All Black

23042M
Black & Chrome

23007M
Black & Solid Brass

23093M
Antique Pewter

23079M
Antique

This Antique Pewter finish was re-introduced in 2014 with an improved quality finish.

Measurements given for coal buckets and hods exclude their handles.



Adeney
 Dia. 250 (10")
 A - 22106
 All Black
 B - 22108
 Black & Brushed Steel
 C - 22107
 Black & Brass



Kinton - Dia. 230 (9")



22008 Black & Brass
 22105 Black & Brushed Steel
 22104 All Black

Sutton - Dia. 280 (11")



22110 Black & Brass
 22111 Black & Brushed Steel
 22109 All Black

Plealey
 Dia. 255 (10")

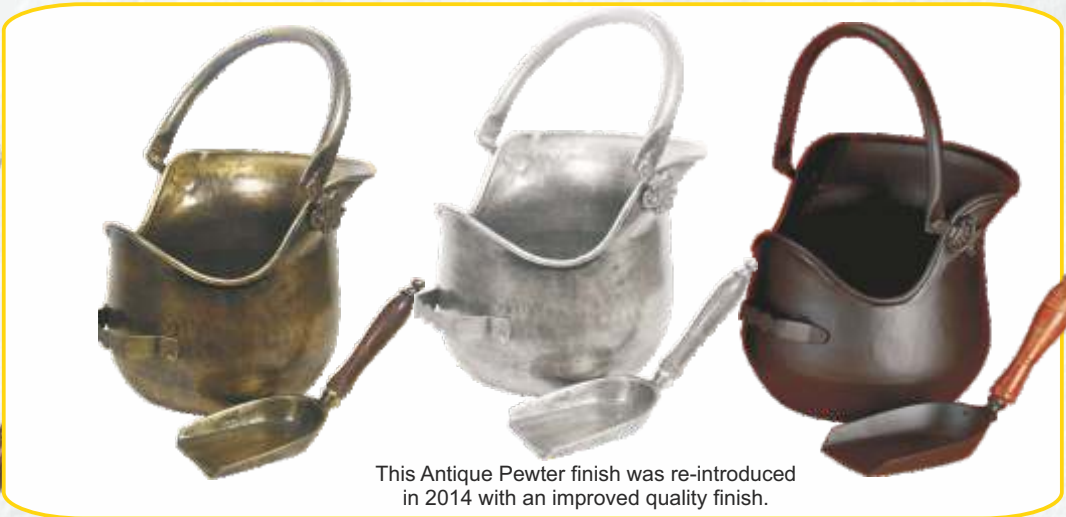

This Antique Pewter finish was re-introduced in 2014 with an improved quality finish.

23081 Antique
 23094 Antique Pewter
 23050 All Black



Measurements given for coal buckets and hods exclude their handles.

Stanton

A - 23077
All Black with Shovel

B - 23078
Antique with Shovel

Dia. 240 (9.5")



A



B



Nobold

Dia. 250 (10")

Lawley

Dia. 250 (10")



23056
All Black
with Shovel

23037
All Black

Waterloo

Dia. 345 (13.5")

Rowton

Dia. 255 (10")

Astley

380W 205D (15x8")



23061
All Black

23054 - All Black

23016
All Black

Kindling Bucket



Measurements given for kindling & ash buckets exclude their handles.

Ash Bucket & Lid



23116
Ivory Printed Kindling Bucket
Dia.300 (12")

23118
Black Printed Kindling Bucket
Dia.300 (12")



23117
Ivory Printed Ash Bucket & Lid
Dia.300 (12")

23119
Black Printed Ash Bucket & Lid
Dia.300 (12")

Although visually identical, these ranges of products are generally better quality and heavier than items offered elsewhere



The Printed Ivory range consists of
23116 Kindling Bucket
23117 Ash Bucket & Lid



The Printed Black range consists of
23118 Kindling Bucket
23119 Ash Bucket & Lid

This existing coal bucket is also ideal for the popular shorter kindling and holds the full retail sales pack.



Astley

23016
Black
380W 205D (15x8")

Kindling Baskets

CW Kindling Basket

Will hold just over half of the retail sales pack of the shorter popular kindling



23101
H130 W305 D200
(5x12x8")
Excludes handles

Ring



Suitable for all kindling

23090
Black
H230 W215 D215 (9x8.5x8.5")

Round Kindling Basket

Suitable for all kindling

23122
H330 Dia.380
(13x15")



CW Kindling Holder



Will hold just under half of the retail sales pack of the shorter popular kindling

23095
Black
H180 W220 (7x8.75")

Marton



Suitable for kindling of around 250mm long

23091
Black
H240 W215 (9.5x8.5")

CALFIRE Log Carriers

Roden



23062
Black
H265 W510 D290
(10x20x11")



23082
Antique
H265 W510 D290 (10x20x11")

Westley



23064
Black
H370 W535 D390 (14x21x15")

Felton



The Felton is supplied flat packed and requires assembly.

Supplied with Tools

23065
Black H615 W400 D300 (24x16x12")

Clive

Logs not supplied



23114
Nylon Log Tote & Stand
H410 W410 D390
(16x16x15.5")

Basic



This Basic Log Carrier is part of a set of 'basic products' that are available. Also see the 'Basic' fire set on page 10 and the 'Basic' fire screen on page 22.

23107
Black
H330 W405 D330 (13x16x13")

CALFIRE Log Carriers

Sling
Carrier



23112

Black H405 W710 D240 (16x28x9.5")

Malmo



NEW
2016



Matching
companion
set available.
See page 12

Logs not supplied

23121

Black H690 W280 D250 (27x11x10")

Stockholm



NEW
2016



Logs not supplied

23120

Set2 Log & Kindling Holders
Log: H295 Dia330 (11.5x13")
Kindling: H220 Dia200 (8.5x8")

CALFIRE
The Fireside Collection



Ring
20"



23108

H570 W510 D230
(22.5x20x9")

Ring
27.5"

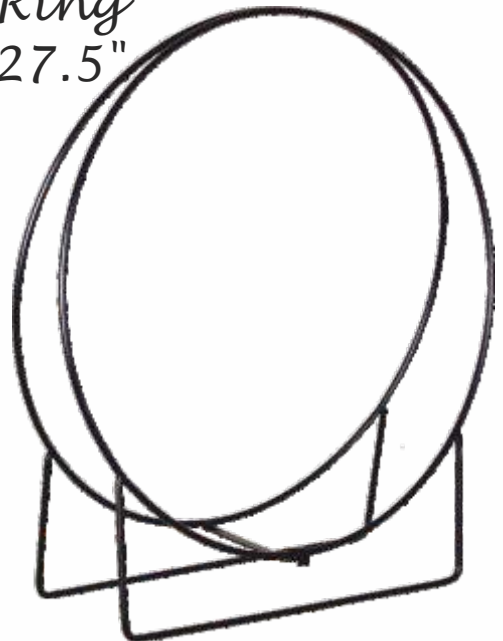

Easy assembly

23113

H760 W700 D230
(30x27.5x9")



Supply your own timber to create the log rack you require

Log Rack Brackets

23111

Set4

Brackets fits standard planed wood size 38 x 89mm; this is available from most hardware stores

Each bracket measures:
H150 W95 D100 (6x3.75x4")

4' Log Rack

23109

H1220 W1220 D340 (48x48x13.5")



Assembly required

Supply your own timber to create the log rack you require

Log Rack Ends

23110

Set2

Brackets fits standard planed wood size 38 x 89mm; this is available from most hardware stores.

Each frame measures:
1120H 290W (44"x11.5")



CALFIRE Log Baskets



23083
Wild Willow Log Basket
Full wild willow with
external handles and
hessian lining
Height 381 Dia.508
(15x20")



*See page 38
for basket kindling
holders*

Measurements given for log baskets exclude their handles.



23084
Wild Willow Log Basket
Full wild willow with external handles
Height 381 Dia.508 (15x20")



23123
Buff Willow Tall Log Basket
Full double steamed buff willow with rustic stripe.
Height 370 Dia.510 (15x20")

Measurements given for log baskets exclude their handles.



23102
Round Rustic Log Basket
Full rustic and buff with integral handles
Height 390 Dia.480 (15.5x19")



23096
Buff Willow Tall Log Basket with Lining
Full double steamed buff willow with rustic stripe and hessian lining.
Height 560 Dia.510 (22x20")



23068
Set2 Open Ended Log Baskets
Full buff triple weave willow with rustic stripe
Large Basket H330 W368 D483 (13x14.5x19")



23098
Set2 Deep Mill Log Baskets
Full wild willow with rope handles.
Large H385 W660 D470 (15x26x18.5")



23124
Set2 Country Buff Willow Log Baskets
Full double steamed buff and rustic willow with lining
Large Basket H400 Dia.500 (16x20")



23125
Set2 Provence Tall Round Willow Log Baskets
Full buff willow with wash finish and lining
Large Basket H570 Dia.550 (20x22")

Measurements given for log baskets exclude their handles.



23099
Set3 Buff Willow Log Baskets
Full buff double steamed and green willow
Large H390 W615 D460 (15.5x24x18")



23100
Set3 Round Willow Log Baskets
Full double steamed buff & green willow with rope handles
Large Basket Dia.495 (19.5")

CALFIRE Castings

Traditional Fire Backs - up to 24" wide

CALFIRE are proud to announce that they acquired the supply of the highly acclaimed range of quality castings from Kingsworthy Foundry in the autumn of 2010.

These Premier quality castings, British Made fire baskets, fire dogs etc from the Kingsworthy range are detailed within pages 44-57 of this catalogue.

Where Premier range alternatives are available, these are cross referenced within the catalogue.

Rose & Portcullis

K39
22Kg



35185
W395 H535 (15.5x21")

Phoenix

K18
40Kg



35225
W455 H560 (18x22")

Ironfounder

K27
33Kg



35226
W480 H505 (19x20")

Tree of Life

K9
35Kg



35186
W495 H730 (19.5x28.75")

Individual sizes & weights are provided for guidance only; due to the manufacturing process the actual product may vary.

Two Cherubs

K36
48Kg



35227
W495 H680 (19.5x26.75")

Royal Coat of Arms

K8
37Kg



35188
W535 H655 (21x26")

Fleur-de-lys

K43F
21Kg



35184
W575 H415 (22.5x16.5")

Lion

K43L
33Kg



35224
W590 H415 (23.25x16.25")

CALFIRE Castings

Traditional Fire Backs - up to 24" wide

With our range of traditional cast iron firebacks, there is something to fit the smaller fireplace opening through to the larger inglenook.

Most of the firebacks are copies of authentic originals, some of which date back to the seventeenth century, and are ideal for those trying to maintain the historical charm of an old inglenook.

Sizes range from 405 mm (16") wide to the 1065 mm (42") wide 'Large Royal Oak' fireback; probably the largest fireback now available within the UK.

Coat of Arms
1635



35128
W595 H510 (23.5x20")

Shield



35229
W590 H575 (23.25x22.5")

Individual sizes & weights are provided for guidance only; due to the manufacturing process the actual product may vary.

Plain



35129
W605 H495 (23.75x19.5")

Pikemen



35228
W590 H550 (23.5x22")



The above brick-backed fireplace is protected by a K7 Pikemen cast iron Fireback with Barley Twist Dogs supporting a 24" Swansnest basket. The fireplace is complimented with the Regent companion set.

CALFIRE Castings

Traditional Fire Backs - up to 30" wide

Kingsworthy Foundry traditional quality fireside accessories for log and coal burning fires, now available exclusively to the trade from CALFIRE

The thickness of our firebacks vary from ½" to 2" according to size. All firebacks are painted black. To install simply lean the fireback against the rear of the fireplace. Some firebacks are still hand moulded and cast in much the same way as they have been for generations. Apart from the aesthetic value, firebacks prevent scorching of the rear brickwork and help to radiate heat - a point worth remembering when installing a gas log or coal effect fire as they are equally effective with this type of appliance as with the traditional natural log or coal fire.

Rope Twist

K37
42Kg



35163
W660 H495 (26x19.5")

Large Flowers

K5
112Kg



35160
W725 H885 (28.5x34.75")

Laughing Lion

K13
71Kg



35127
W725 H650 (28.5x25.5")

Individual sizes & weights are provided for guidance only; due to the manufacturing process the actual product may vary.

Lion & Unicorn

K1
70Kg



35126
W735 H660 (28.75x26")

Plain

K13P
57Kg



35140 W740 H665 (29x26")

Horse Chestnut

K51
68Kg



35158
W740 H645 (29.25x25.25")

CALFIRE Castings

Traditional Fire Backs - for the larger inglenook



Please note: The firebacks on Pages 46-48 are particularly heavy, therefore in the interests of Health & Safety we recommend 2/3 people are used to lift or move them.

The thickness of our firebacks vary from ½" to 2" according to size. All firebacks are painted black. To install simply lean the fireback against the rear of the fireplace. Some firebacks are still hand moulded and cast in much the same way as they have been for generations. Apart from the aesthetic value, firebacks prevent scorching of the rear brickwork and help to radiate heat - a point worth remembering when installing a gas log or coal effect fire as they are equally effective with this type of appliance as with the traditional natural log or coal fire.

K46
129Kg



Large Shield

35159

W810 H1070 (31.75x42")

Royal Oak Midi

K22
113Kg



35125

W845 H720 (33.25x28.5")

Individual sizes & weights are provided for guidance only; due to the manufacturing process the actual product may vary.

Fairfax

K47
79Kg



35187

W860 H685 (34x27")



The Royal Oak Fireback is shown here with Barley Twist Dogs supporting a 30" 4 sided Swansnest basket.

Traditional Fire Backs - for the larger inglenook

*Kingsworthy Foundry
traditional quality fireside
accessories for log and
coal burning fires, now
available exclusively to the
trade from CALFIRE*

The thickness of our firebacks vary from ½" to 2" according to size. All firebacks are painted black. To install simply lean the fireback against the rear of the fireplace. Some firebacks are still hand moulded and cast in much the same way as they have been for generations. Apart from the aesthetic value, firebacks prevent scorching of the rear brickwork and help to radiate heat - a point worth remembering when installing a gas log or coal effect fire as they are equally effective with this type of appliance as with the traditional natural log or coal fire.

Medieval Large

**K41L
114Kg**



35183

W875 H805 (34.5x31.5")

Lion & Unicorn

**K4
148Kg**



35162

W965 H775 (38.25x30.5")

Individual sizes & weights are provided for guidance only; due to the manufacturing process the actual product may vary.

Royal Oak Large

**K22L
180Kg**



35124

W1070 H835 (42x33.25")



Please note: The firebacks on Pages 46-48 are particularly heavy, therefore in the interests of Health & Safety we recommend 2/3 people are used to lift or move them.

CALFIRE Castings

Slide-in Fire Backs

These "slide-in" cast iron firebacks are designed to fit in specific firebaskets as shown on pages 53-54.

Individual sizes & weights are provided for guidance only; due to the manufacturing process the actual product may vary.

Fleur-de-lys

Plain

Lion

**K57F
9Kg**



**K57P
9Kg**



**K57L
9Kg**



Plain fireback shown with Modula Mini Basket

35150

W395 H275 (15.5x10.75")

35151

W395 H280 (15.5x11")

35221

W395 H270 (15.5x10.5")



Fleur-de-Lys fireback shown with Popular Black Knobs Standard Basket

Fleur-de-lys

Plain

**K58F
14Kg**



**K58P
14Kg**



35121

W470 H360 (18.5x14.25")

35154

W460 H365 (18x14.25")

Fleur-de-lys

Plain

**K59F
18Kg**



**K59P
18Kg**



Plain fireback shown with Popular Plain Medium Basket

35153

W550 H360 (21.75x14.25")

35152

W560 H365 (22x14.5")

CALFIRE Castings

Reeded Panels



*Kingsworthy Foundry
traditional quality
fireside accessories for
log and coal burning
fires, now available
exclusively to the
trade from CALFIRE*

Please note: The larger reeded panels detailed on this page are particularly heavy, therefore in the interests of Health & Safety we recommend 2/3 people are used to lift or move them.



K56



Cross section showing Reeded form



The above wood-panelled fireplace interior is lined with cast iron Reeded Panels and a 24" Swansnest basket supported by Barley Twist Dogs.

Individual sizes & weights are provided for guidance only; due to the manufacturing process the actual product may vary.

Reeded Panels are used where the complete interior of the fireplace is required to be lined, as is the case of the re-building of a Georgian fireplace, or when reproducing a "period style fireplace". A cast iron firegrate with integral small back should be used with this type of fireplace (as example above).

35132 W405 H915 (16x36") 41Kg

35133 W405 H1015 (16x40") 43Kg

35134 W455 H915 (18x36") 46Kg

35135 W455 H1015 (18x40") 49Kg

35136 W760 H915 (30x36") 78Kg

35137 W760 H1015 (30x40") 87Kg

35138 W1220 H1015 (48x40") 145Kg

35139 W1525 H1015 (60x40") 156Kg

*Sizes approximate - please allow
12mm (½") tolerance.*

CALFIRE Castings

Traditional Firedogs

Firedogs are used as ornamental supports for Dog Grate/Baskets. Consideration should be given to the extra width required in a fireplace opening to accommodate the feet span of the dogs.

Cast Iron Dogs can, if preferred be used without a Dog Basket. Seasoned logs can be lent against the cross bars and burnt on the hearth base, providing there is a good draw in the chimney.

All Fire Dogs sold as pairs

Canterbury

Although not from the Kingsworthy Range these quality British Made Dogs must be considered part of our Premier Castings Range.



34013
Solid Brass Canterbury
H380 (15")

Scroll Dogs



Medium 34170
W260 D515 H440 (10.25x20.25x17.25")
Large 34171
W345 D620 H560 (13.5x24.5x22")

Ball Head Dogs



Medium 34115
W260 D525 H415 (10.25x20.75x16.25")
Large 34116
W340 D660 H590 (13.5x26x23.25")

Mulling Dogs

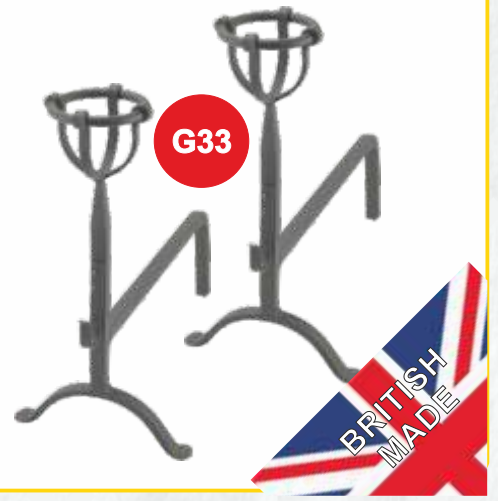

Medium 34117
W250 D515 H475 (9.75x20.25x18.75")
Large 34118
W310 D605 H630 (12.25x23.75x24.75")

Pinnacle Dogs (Cast Iron)



35122
W195 D485 H405 (7.75x19x16")

Barley Twist Dogs (Cast Iron)



35123 W255 D465 H430 (10x18.25x17")

Column Dogs (Cast Iron)



35164
W210 D465 H380 (8.25x18.25x15")

CALFIRE Castings

Tapered Firegrates

*Kingsworthy Foundry
traditional quality fireside
accessories for log and coal
burning fires, now available
exclusively to the trade
from CALFIRE*

*These Tapered Firegrates
are supplied as shown in the
pictures. Draught Covers, Ash
Pans and Replacement Grids
are available separately as
detailed in the product
information.*

Portcullis & Swan

Dimensions:

16"- W400/255 D240 H290 (15.75/10x9.5x11.5")
18"- W450/300 D240 H290 (17.75/11.75x9.5x11.5")

G8

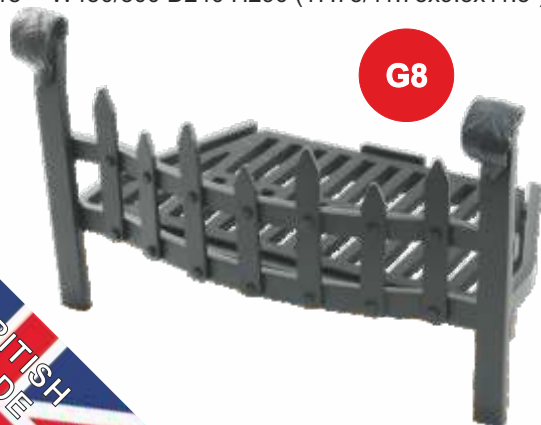

16" P & S Firegrate 34172
16" Ash Pan 34137
16" Replacement Grid 35141

18" P & S Firegrate 34173
18" Ash Pan 34138
18" Replacement Grid 35142

Portcullis & Urns

Dimensions:

16"- W385/255 D240 H275 (15.25/10x9.5x10.75")
18"- W440/300 D240 H290 (17.25/11.75x9.5x11.5")

G2

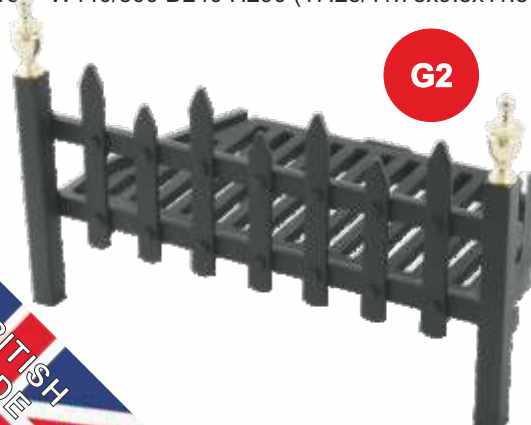

16" P & U Firegrate 34174
16" Ash Pan 34137
16" Replacement Grid 35141

18" P & U Firegrate 34175
18" Ash Pan 34138
18" Replacement Grid 35142

Ultra

Dimensions:

16"- W395/255 D240 H175 (15.5/10x9.5x7")
18"- W445/290 D240 H175 (17.5/11.5x9.5x7")

G55



Includes Draught Cover

16" Ultra Firegrate 34101
16" Ash Pan 34137
16" Replacement Grid 35141

18" Ultra Firegrate 34102
18" Ash Pan 34138
18" Replacement Grid 35142

Windsor Inset

Dimensions:

16"- W405/240 D280 H220 (16/9.5x11x8.75")
18"- W455/285 D285 H220 (18/11.25x11.25x8.75")

G11

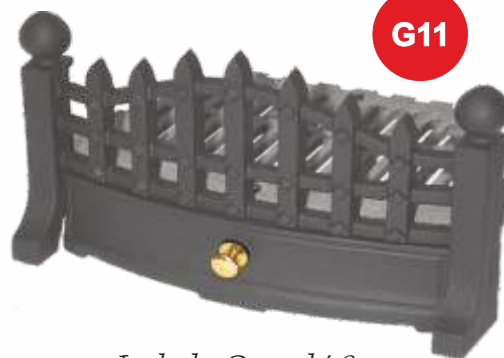

Includes Draught Cover

16" Windsor Inset 35130
16" Ash Pan 34137
16" Replacement Grid 35130G

18" Windsor Inset 35131
18" Ash Pan 34138
18" Replacement Grid 35131G



British Firebaskets - Please note that the cast iron replaceable fire grids and the slot-in firebacks are manufactured in China.

*Kingsworthy Foundry
traditional quality fireside
accessories for log and
coal burning fires, now
available exclusively to the
trade from CALFIRE*

*Replacement
grids are available
for all British Firebaskets.
See Page 57 for
details.*

CALFIRE
The Fireside Collection



See page 49 for larger illustrations of the available Standard fireback options.



See page 44 for larger illustrations of the available Medium K43 fireback options.

*Portcullis with
Swan Neck*

G20



*Portcullis with Swan
Neck & Back*

G21



G21 with Fleur-de-Lys Back:

Standard 34191
Medium 34194
(Standard F-D-L shown):

G21 with Plain Back:

Standard 34192

G21 with Lion Back:

Medium 34196

Dimensions:

Standard - W485 D350 H335 (19x13.75x13.25")
Medium - W640 D350 H335 (25.25x13.75x13.25")
Large - W735 D455 H425 (29x18x16.75")

Ashpans, Draught Covers and replacement Grids available - See Page 57 for details

G20 Basket:

Standard 34188 - Medium 34189 - Large 34190

When fitting the optional slot-in firebacks the overall height will increase by approx. 135mm (5.25") with the Standard size and approx. 190mm (7.5") with the Medium Sizes

Ducksnest

G24



Ducksnest for Dogs
(Shown with British Ball Head Dogs)

G26



G26 Dimensions:
Standard W620/545 D275 H150 (24.5/21.5x10.75x6")
Medium W750/615 D330 H150 (29.5/24.25x13x6")
Large W850/750 D440 H180 (33.5/29.5x17.25x7")

Dimensions do not include Firedogs. Depending on choice, Firedogs will lift these baskets by 6-7" and extend the width by 6-12". Please see page 51 for Firedog dimensions.

G24 Dimensions:

Standard - W545 D275 H250 (21.5x10.75x9.75")
Medium - W615 D330 H260 (24.25x13x10.25")
Large - W750 D440 H285 (29.5x17.25x11.25")

Ashpans, Covers and replacement Grids available - See Page 57 for details

G24 Basket: Standard 34109
Medium 34110
Large 34111

G26 Ducksnest for Dogs: Standard 34112
Medium 34113
Large 34114

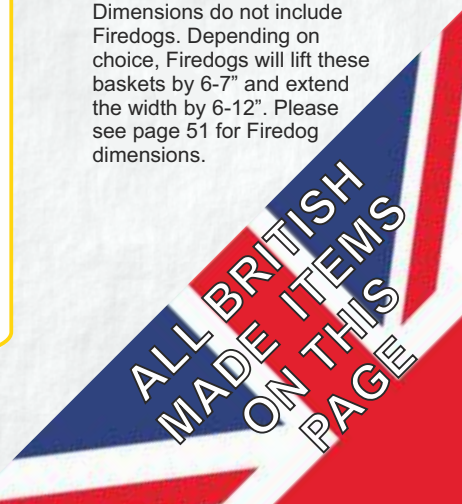



British Firebaskets - Please note that the cast iron replaceable fire grids and the slot-in firebacks are manufactured in China.

Popular - Black Knobs



G14

Popular - Black Knobs with Back



G15

Dimensions:

Mini - W450 D290 H310 (17.75x11.5x12.25")
Standard - W520 D345 H345 (20.5x13.5x13.5")
Medium - W605 D345 H345 (23.75x13.5x13.5")

Ashpans, Draught Covers and replacement Grids available - See Page 57 for details

G14 Basket:

Mini 34106 - Standard 34107 - Medium 34108

When fitting the optional slot-in firebacks the overall height will increase by approx. 90mm (3.5") with the Mini size and approx. 135mm (5.25") with the Standard and Medium Sizes



See page 49 for larger illustrations of the available fireback options.

G15 with Fleur-de-Lys Back:

Mini 34152
Standard 34155
Medium 34158
(Standard F-D-L shown)

G15 with Plain Back:

Mini 34153
Standard 34156
Medium 34159

G15 with Lion Back:

Mini 34154

Popular Plain



G61

Popular Plain with Back



G63

Dimensions:

Mini - W420 D275 H250 (16.5x10.75x9.75")
Standard - W490 D330 H250 (19.25x13x9.75")
Medium - W580 D345 H250 (22.75x13.5x9.75")

Ashpans, Draught Covers and replacement Grids available - See Page 57 for details

G61 Basket:

Mini 34103 - Standard 34104 - Medium 34105

When fitting the optional slot-in firebacks the overall height will increase by approx. 145mm (5.75") with the Mini size and approx. 235mm (9.25") with the Standard and Medium Sizes



See page 49 for larger illustrations of the available fireback options.

G63 with Fleur-de-Lys Back:

Mini 34161
Standard 34164
Medium 34167

G63 with Plain Back:

Mini 34162
Standard 34165
Medium 34168

G63 with Lion Back:

Mini 34163

Modula

Includes Draught Cover



G68

Modula with Back

Includes Draught Cover



G69

Dimensions:

Mini - W430 D280 H255 (17x11x10")
Standard - W495 D335 H255 (19.5x13.25x10")
Medium - W585 D335 H255 (23x13.25x10")

Ashpans and replacement Grids available - See Page 57 for details

G68 Basket: Mini 34176 - Standard 34177 - Medium 34178

When fitting the optional slot-in firebacks the overall height will increase by approx. 180mm (7") with the Mini size and approx. 260mm (10.25") with the Standard and Medium Sizes

G69 with Fleur-de-Lys Back:

Mini 34179
Standard 34182
Medium 34185

G69 with Plain Back:

Mini 34180
Standard 34183
Medium 34186
(Mini Plain shown):

G69 with Lion Back:

Mini 34181





Fire Baskets Cast Iron

*Spanish
with Back*



**C9Std
23Kg**



**C9Med
28Kg**

*Combined Cover/Ashpan's sold separately.
Replacement Grids available.*

C9 Standard 35176
W470 D290 H455 (18.5x11.5x18")
Combined Cover/Ashpan 35191
Replacement Grid 35246

C9 Medium 35177
W545 D300 H465 (21.5x11.75x18.25")
Combined Cover/Ashpan 35192
Replacement Grid 35247

*Original Cromwell
with Back*
(Original Heavy
KWF Product)



**C11B
25Kg**

Combined Cover/Ashpan's sold separately

C11B Standard 35239 W430 D275 H335 (17x10.75x13.25")
Combined Cover/Ashpan - Standard 35195
(Fireback Only K60 35161)

*Adam
No.2*



**C2
40Kg**

Cover sold separately

C2 Basket 35120 W570 D330 H635 (22.5x13x25")
Cover 35193

Individual weights are provided for guidance only; the actual product may vary slightly.

Original Cromwell
(Original Heavy
KWF Product)



C11

**Weights:
Standard - 16.5Kg
Large - 22Kg**

Combined Cover/Ashpan's sold separately

C11 Standard 35118 W430 D275 H150 (17x10.75x6")
C11 Large 35119 W535 D305 H150 (21x12x6")
Combined Cover/Ashpan: Standard 35195 - Large 35196

New Cromwell
(New Medium
Weight Product)



C12

**Weights:
Standard - 11.5Kg
Large - 15.5Kg**

*These weights are heavier than many other suppliers standard items.
Combined Cover/Ashpan's sold separately*

C12 Standard 35241 W430 D275 H150 (17x10.75x6")
C12 Large 35242 W535 D305 H150 (21x12x6")
Combined Cover/Ashpan: Standard 35195 - Large 35196

Fire Baskets Cast Iron

Swansnest for dogs

C13



Shown on G36 Pinnacle Dogs
Dimensions do not include firedogs

- C13 18" **35166** W440 D280 H165 (17.25x11x6.5")
- C13 24" **35167** W590 D320 H165 (23.25x12.5x6.5")
- C13 30" **35168** W730 D405 H165 (28.75x16x6.5")
- C13 36" **35169** W900 D415 H165 (35.5x16.25x6.5")

Swansnest freestanding

C14



These items can be supplied with Plain Legs as shown.
Dimensions as C13 range with Height increased to 240mm (9.5")

- With Plain Legs:
- C14 18" **35208**
 - C14 24" **35210**
 - C14 30" **35212**
 - C14 36" **35214**

Swansnest - 3 sided for dogs

C20



Shown on G40 Barley Twist Dogs
Dimensions do not include firedogs

- C20 18" **35145** W445 D305 H165 (17.5x12x6.5")
- C20 24" **35146** W610 D355 H165 (24x14x6.5")
- C20 30" **35147** W750 D415 H165 (29.5x16.25x6.5")
- C20 36" **35148** W890 D415 H165 (35x16.25x6.5")
- C20 42" **35149** W1040 D415 H165 (41x16.25x6.5")

Swansnest - 3 sided freestanding

C21



These items can be supplied with Plain Legs as shown.
Dimensions as C20 range with Height increased to 240mm (9.5")

- With Plain Legs:
- C21 18" **35198**
 - C21 24" **35200**
 - C21 30" **35202**
 - C21 36" **35204**
 - C21 42" **35206**

Log Cradle for dogs

C30



Shown on G41 Column Dogs.
Use with bar at front or back.
Dimensions do not include firedogs

- C30 18" **35155** W445 D305 H100 (17.5x12x4")
- C30 24" **35156** W610 D355 H100 (24x14x4")
- C30 30" **35157** W750 D415 H100 (29.5x16.25x4")

Log Cradle freestanding

C31



These items can be supplied with Plain Legs as shown.
Dimensions as C30 range with Height increased to 165mm (6.5")
Use with bar at front or back

- Plain Legs:
- C31 18" **35216**
 - C31 24" **35218**
 - C31 30" **35220**

Miscellaneous

Ash Pans

A20



- 34137 A20/A 16" Milner
- 34138 A20/B 18" Milner
- 34139 A20/C 11.5x9.25"
- 34140 A20/D 14.25x9.25"
- 34141 A20/E 14.25x10.5"
- 34142 A20/F 15.75x10.5"
- 34143 A20/G 17x10.5"
- 34145 A20/I 19.5x10.5"
- 34146 A20/J 20.5x10.5"
- 34148 A20/L 25x15"
- 34149 A20/M 18x15"
- 34151 A20/O 20x14"

Ashpan Covers

A21



- 34119 A21/02 14.75x4"
- 34120 A21/03 17.25x4"
- 34121 A21/04 21.25x4"
- 34127 A21/13 Unique
- 34130 A21/17 Unique
- 34131 A21/18 Unique

Where a cover is marked as 'Unique' it is NOT a rectangular shape and only fits the baskets indicated in the listing on the right.

Milner Grids

To fit Tapered Grates G2, G8 & G55 on Page 51

A18



- 35141 405mm (16")
- 35142 455mm (18")

Rectangular Grids

See list on right for details of which grid is used on which basket

A18
&
C09



- 35171 A18 Ref.B 395x240mm (15.5x9.5")
- 35172 A18 Ref.C 455x305mm (18x12")
- 35173 A18 Ref.F (Sold in pairs) each one measures 215x280mm (8.5x11")
- 35174 A18 Ref.G 375x220mm (14.75x8.75")
- 35246 C09 18" Spanish Grid
- 35247 C09 21" Spanish Grid

Loose Bars

Used in conjunction with Rectangular Grids on some baskets.

A18



- 35143 Standard 250x30mm (9.75x1.25")
- 35144 Medium 280x30mm (11x1.25")

Former Kingsworthy Products Ashpan, Draught Cover & Replacement Grid Guide

This list does not include items already detailed in the catalogue.

CODE	DESCRIPTION	ASHPAN	COVER	GRID
34103	G61 MINI POPULAR PLAIN	34140	34119	35174
34104	G61 STANDARD POPULAR PLAIN	34143	34120	1pr x 35173
34105	G61 MEDIUM POPULAR PLAIN	34146	34121	1pr x 35173 + 3 x 35144
34106	G14 MINI POPULAR - BLACK KNOBS	34140	34119	35174
34107	G14 STANDARD POPULAR - BLACK KNOBS	34143	34120	1pr x 35173
34108	G14 MEDIUM POPULAR - BLACK KNOBS	34146	34121	1pr x 35173 + 3 x 35144
34109	G24 STANDARD DUCKNEST	34139	34130	1 x 35171 + 6 x 35143
34110	G24 MEDIUM DUCKNEST	34142	34131	1pr x 35173 + 6 x 35144
34111	G24 LARGE DUCKNEST	34151	34127	2 x 35174
34112	G26 STANDARD DUCKNEST FOR DOGS		34120	1 x 35171 + 6 x 35143
34113	G26 MEDIUM DUCKNEST FOR DOGS		34121	1pr x 35173 + 6 x 35144
34114	G26 LARGE DUCKNEST FOR DOGS			2 x 35174
34152/53/54	G15 MINI POPULAR + VARIOUS FIREBACK OPTIONS	34140	34119	35174
34155/56	G15 STANDARD POPULAR + VARIOUS FIREBACK OPTIONS	34143	34120	1pr x 35173
34158/59	G15 MEDIUM POPULAR + VARIOUS FIREBACK OPTIONS	34146	34121	1pr x 35173 + 3 x 35144
34161/62/63	G63 MINI POPULAR PLAIN + VARIOUS FIREBACK OPTIONS	34140	34119	35174
34164/65	G63 STANDARD POPULAR PLAIN + VARIOUS FIREBACK OPTIONS	34143	34120	1pr x 35173
34167/68	G63 MEDIUM POPULAR PLAIN + VARIOUS FIREBACK OPTIONS	34146	34121	1pr x 35173 + 3 x 35144
34176	G68 MINI MODULA	34140	Inc	35174
34177	G68 STANDARD MODULA	34143	Inc	1pr x 35173
34178	G68 MEDIUM MODULA	34146	Inc	1pr x 35173 + 3 x 35144
34179/80/81	G69 MINI MODULA + VARIOUS FIREBACK OPTIONS	34140	Inc	35174
34182/83	G69 STANDARD MODULA + VARIOUS FIREBACK OPTIONS	34143	Inc	1pr x 35173
34185/86	G69 MEDIUM MODULA + VARIOUS FIREBACK OPTIONS	34146	Inc	1pr x 35173 + 3 x 35144
34188	G20 STANDARD PORTCULLIS WITH SWAN NECK	34141	34120	1pr x 35173
34189	G20 MEDIUM PORTCULLIS WITH SWAN NECK	34146	34121	1pr x 35173 + 3 x 35144
34190	G20 LARGE PORTCULLIS WITH SWAN NECK			3 x 35174
34191/92	G21 STANDARD PORTCULLIS WITH SWAN NECK + VARIOUS FB'S	34141	34120	1pr x 35173
34194/96	G21 MEDIUM PORTCULLIS WITH SWAN NECK + VARIOUS FB'S	34146	34121	1pr x 35173 + 3 x 35144

Traditional Fire Baskets - See Price List for Gas Burner Availability.

Cottage



This item is reversible and can be used with an All Black front or a Polished front.

Solid Fuel Kit sold separately

Small Cottage 35057 W495 D305 H370 (19.5x12x14.5")

Large Cottage 35049 W540 D305 H480 (22x12x19")

Solid Fuel Kit SFK26 35113

The Solid Fuel Kit for this product includes only the fire grid.

Solid Fuel Kit sold separately

Castle



Castle Basket 35090
W570 D280 H440 (22x11x17")
Solid Fuel Kit SFK22C 35114



Individual sizes & weights are provided for guidance only; due to the manufacturing process the actual product may vary.

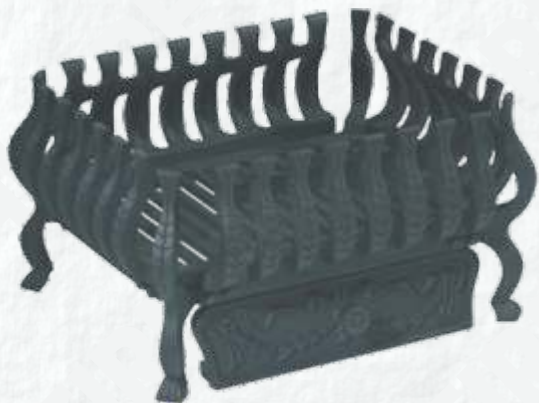

Valencia



Solid Fuel Kits sold separately

16" 35099 W400 D330 H220. Solid Fuel Kit SFK23 35110

18" 35100 W470 D335 H220. Solid Fuel Kit SFK12 35112

21" 35101 W550 D330 H220. Solid Fuel Kit SFK14 35116

Modern Fire Baskets - See Price List for Gas Burner Availability.

Neon - Dimensions: W380 D280 H225 (15x11x9")



*Solid Fuel Kit sold separately
Shown with backs fitted although these can be removed*

Polished Neon 35035
Solid Fuel Kit SFK23 35110

Black Neon 35036
Solid Fuel Kit SFK23 35110

Elan No Back - Dimensions: W435 D295 H210 (17x12x8")



Solid Fuel Kit sold separately

Polished Elan No Back 35037
Solid Fuel Kit SFK12 35112

Black Elan No Back 35038
Solid Fuel Kit SFK12 35112



With these baskets choose a black finish for use with solid fuel as polished surfaces change colour with heat. Polished surfaces can also be affected by the heat from gas appliances although the resultant discolouration will be much less noticeable.

CALFIRE Castings

Modern Fire Baskets - See Price List for Gas Burner Availability.

Krypton - Dimensions: W535 D260 H190 (21x10.25x7.5")



*Solid Fuel Kit sold separately
Shown with and without back fitted*

Polished Krypton 35092
Solid Fuel Kit SFK22K 35115

Black Krypton 35091
Solid Fuel Kit SFK22K 35115

With the Krypton & Elan Baskets choose a black finish for use with solid fuel as polished surfaces change colour with heat.

Polished surfaces can also be affected by the heat from gas appliances although the resultant discolouration will be much less noticeable.

See price list for gas burner availability.



Elan With Back

Dimensions: W460 D305 H410 (18x12x16")

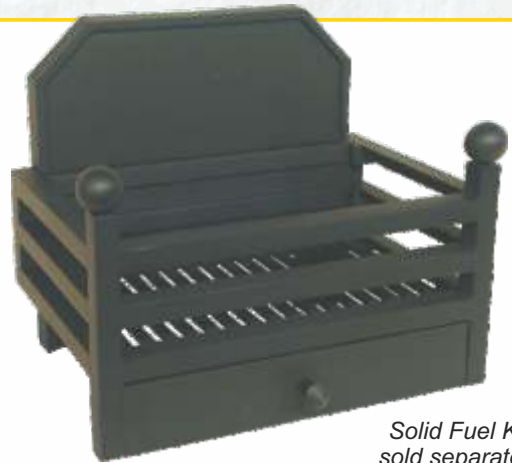

Solid Fuel Kit sold separately

Black Elan With Back 35040
Solid Fuel Kit SFK12 35112



Solid Fuel Kit sold separately

Polished Elan With Back 35039
Solid Fuel Kit SFK12 35112

Modern Fire Baskets - See Price List for Gas Burner Availability.

The Matrix

Dimensions:
W515 D300 H395
(20x12x15.5")

With the Matrix Baskets choose a black finish for use with solid fuel as polished surfaces change colour with heat. Polished surfaces can also be affected by the heat from gas appliances although the resultant discolouration will be much less noticeable.



The Matrix Back 35093
Solid Fuel Kit SFK14 35116

Solid Fuel Kit sold separately



The Matrix Polished 35094
Solid Fuel Kit SFK14 35116

Gas Burners

Calfire offer a range of Gas Fires suitable for use with many of our range of Traditional & Modern Baskets.

LPG Fires are available to order.

See price list for details. Gas Burner codes from 37005



*Shown with Cadiz Basket
(Sorry the Cadiz Basket is itself no longer available)*

CALFIRE Castings

Solid Fuel Fret Sets - Dimensions given for Fret Sets are category sizes relating to standard milner firebacks -



Includes Style Fret, Grate, Ashpan & Ashpan Tool.

Style Solid Fuel Kit
35080 W400 (16")

See Page 52 for CALFIRE PREMIER RANGE alternatives



Includes Beacon Fret, Grate, Ashpan & Ashpan Tool.

Beacon Solid Fuel Kit
35076 W400 (16")
35104 W450 (18")



Includes Joyce Fret, Grate, Ashpan & Ashpan Tool.

Joyce Solid Fuel Kit
35081 W400 (16")

All Night Burners

Dimensions for All Night Burners are category sizes relating to standard milner firebacks

Fire Grates and Ash Pans are included with all 'All Night Burners'

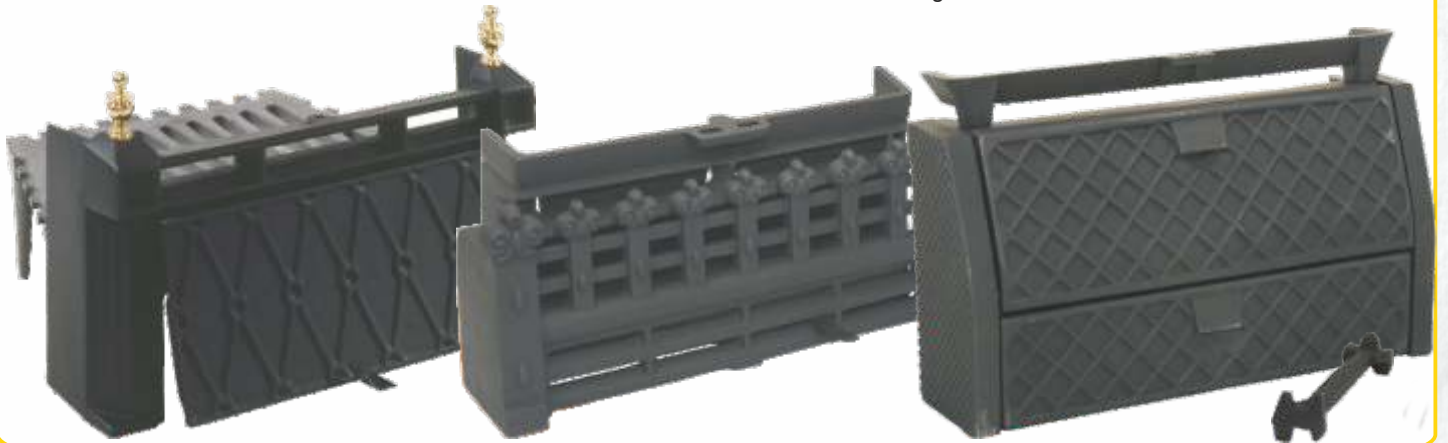

Lattice All Night Burner
35077 W400 (16")
35078 W450 (18")

Regency All Night Burner
35079 W400 (16")

Star All Night Burner
35105 W400 (16")
35106 W450 (18")

Fire Grates

Dimensions for Fire Grates are category sizes relating to standard milner firebacks

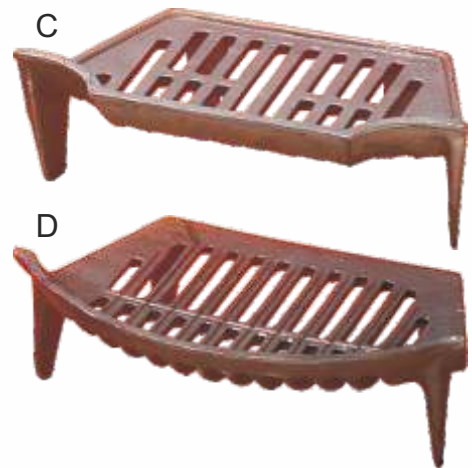
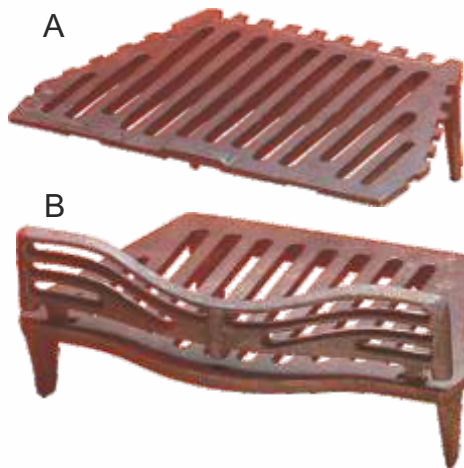

A - Regal Grate
35001 W400 (16")

B - Joyce Grate & Front
35002 W400 (16")
35003 W450 (18")

C - Guardette Grate
35004 W400 (16")
35005 W450 (18")

D - Standard Grate
35006 W400 (16")
35007 W450 (18")

Ash Pans

Dimensions for Ash Pans are category sizes relating to standard milner firebacks



E - Ashpan
34077 W400 (16")

F - Standard Ashpan
34093 W400 (16")
34092 W450 (18")

Kettle

Weight
4Kg



This item is water proof but is coated in a protective paint on the inside, therefore it is recommended for decorative use only.

35240
Kettle with Coil Handle
W260 D210 H230 (10x8.25x9")

Ash Carriers



35075

Room Heater Ash Carrier to suit Charnwood, Parkray & Trianco
W405 H480 (16x19")



35074

Open Fire Ash Carrier to suit 16" & 18" Open Fires
W430 H330 (17x13")

Solid Fuel Frets

Castle



Castle Black
33070 16"
33072 18"

N Type



N Type Black
33066 16"
33068 18"

In addition to the Frets featured on this page you can also choose any of the cast iron frets from pages 65-67.

Style



Style Black
33074 16"
33075 18"

Beacon

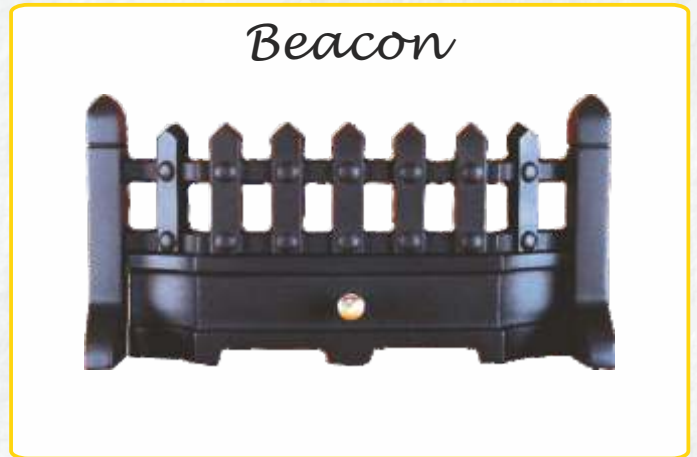

Beacon Black
33021 16"
33024 18"

CALFIRE Frets

Frets - Dimensions given for Frets are category sizes relating to standard milner firebacks.

Grace



Black
33079 W400 (16")



Chrome
33081 W400 (16")



Brass
33080 W400 (16")

Blenheim Solid Cover



Black Cast Iron
33011 W400 (16")
33019 W450 (18")

Black & Polished
33016 W400 (16")
33020 W450 (18")



Chrome
33077 W400 (16")
33078 W450 (18")



Brass
33014 W400 (16")
33017 W450 (18")

Black & Brass
33015 W400 (16")
33018 W450 (18")

Aviva



Black
33095 W400 (16")
33099 W450 (18")



Chrome
33096 W400 (16")
33100 W450 (18")



Brass
33098 W400 (16")
33102 W450 (18")



Satin
33097 W400 (16")
33101 W450 (18")

CALFIRE Frets

Frets - Dimensions given for Frets are category sizes relating to standard milner firebacks

Balmoral



Black Balmoral
33041 W400 (16")

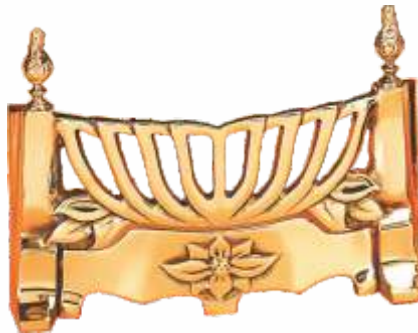

Brass
33005 W400 (16")



Black & Brass
33006 W400 (16")

Daisy



Black
33085 W400 (16")



Chrome
33088 W400
(16")

Black & Chrome
33089
W400 (16")



Brass
33086
W400 (16")

Black & Brass
33087
W400 (16")



Tiffany Art Deco



Chrome
33103 W400 (16")



Brass 33105 W400 (16")



Satin
33104 W400 (16")

CALFIRE Frets & Fire Trims

Frets - Dimensions given for Frets are category sizes relating to standard milner firebacks.

Bauhaus

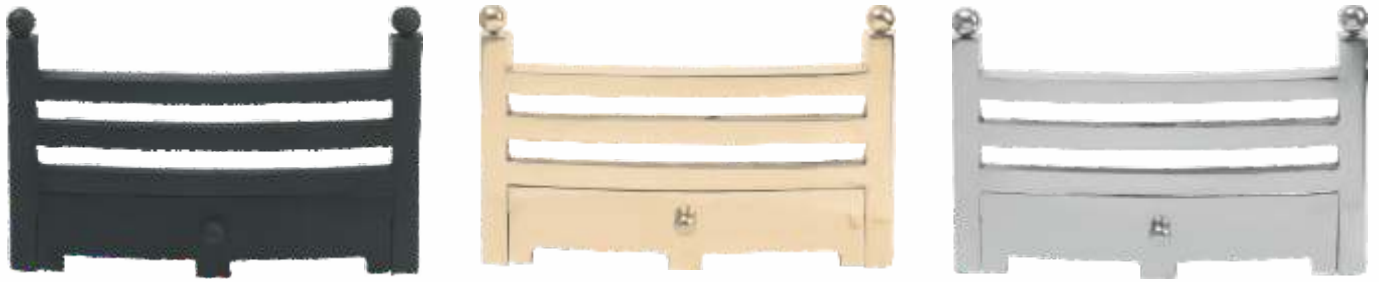

With the Bauhaus Fret choose a black finish for use with solid fuel as polished surfaces change colour with heat. Polished surfaces can also be affected by the heat from gas appliances although the resultant discolouration will be much less noticeable.

Black Cast Iron
33043 W400 (16")
33046 W450 (18")

Antique
33045 W400 (16")
33048 W450 (18")

Polished
33044 W400 (16")
33047 W450 (18")

Fire Trims - Dimensions given for Fire Trims are category sizes relating to standard milner firebacks



All Fire Trims have a height of 560 (22"). Special sizes and Arched Trims are available to order, 3 or 4 sided, in various material finishes. Contact our Sales Office for details.

A. Polished Stainless Steel
36009 W400 (16")
36010 W450 (18")
50 (2") Front, 50 (2") Return

B. Satin Stainless Steel
36011 W400 (16")
36012 W450 (18")
50 (2") Front, 50 (2") Return

C. Black
36007 W400 (16")
36008 W450 (18")
50 (2") Front, 50 (2") Return

D. Brass
36001 W400 (16")
36002 W450 (18")
50 (2") Front, 50 (2") Return
and
36003 W400 (16")
36004 W450 (18")
50 (2") Front, 25 (1") Return

E. Black & Brass
36005 W400 (16")
36006 W450 (18")
50 (2") Front, 50 (2") Return



Club Fenders - Key: **BB** = Brass Backs fitted as standard. **MES** = Minimum extending size possible.
Antique Brass & Satin Chrome finishes now available or any combination i.e. **Black & Satin Chrome**

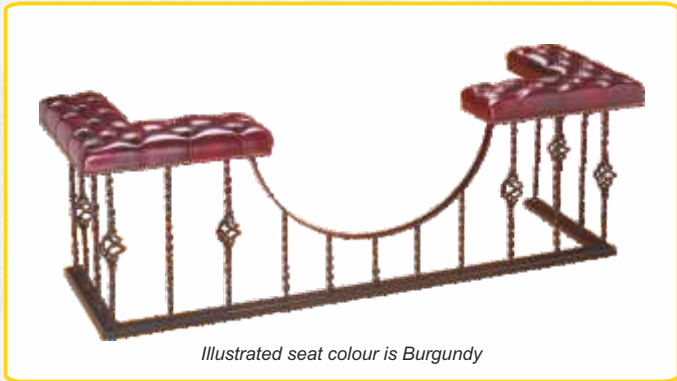

Illustrated seat colour is Burgundy

SPIRAL BLACK

Made to measure only, 4' (1220mm) minimum width.
3 row 'deep' buttons as standard.
Seat size shown approx W6.5"H20.5" (165x520mm)

Incorporating the finest quality hide with close attention to detail, the Club range offers the perfect solution for an exclusive fireside setting. With a range of seat covers including Burgundy, Antique Green, Burnt Copper, Earth Brown, Ocean Blue and Black. Seat styles can be varied to suit personal requirements with models illustrated depicting standard seat designs. For reasons of stability, we recommend a minimum base return of 12"(300mm). We will be pleased to provide a quotation for special sizes and configurations which can be manufactured to your requirements. Optional Brass Backs are available on all models, with the exception of the Regal Club and Spiral Black but are fitted as standard on the Canterbury.



Illustrated seat colour is Antique Green

WINDERMERE

MES 4/5' (1220x1525mm). Unbuttoned as standard.
Seat size shown approx W6.5"H16.5" (165x254mm)

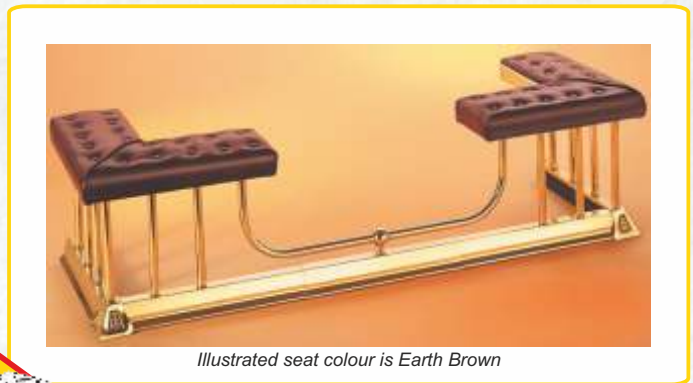

Illustrated seat colour is Earth Brown

MINI MAJESTIC

MES 4/5'. 2 row 'float' buttons as standard.
Seat size shown approx W6.5"H14" (165x254mm)

all items
on this page
can be made
to measure



Illustrated seat colour is Ocean Blue

MAJESTIC

MES 4/5' (1220x1525mm). 3 row 'float' buttons as standard.
Seat size shown approx W7.75"H20" (195x510mm)

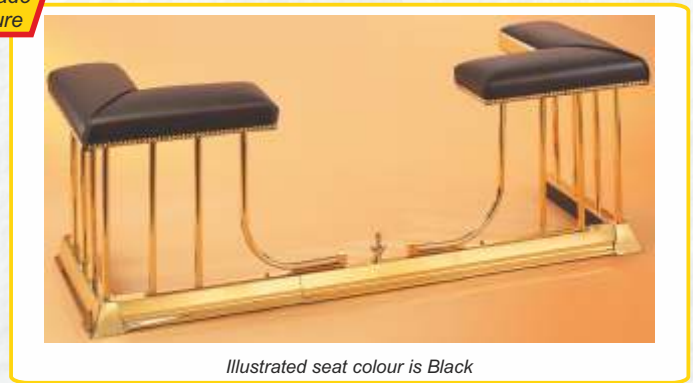

Illustrated seat colour is Black

REGENT

MES 4/5' (1220x1525mm). Unbuttoned as standard.
Seat size shown approx W6.5"H18" (165x460mm)

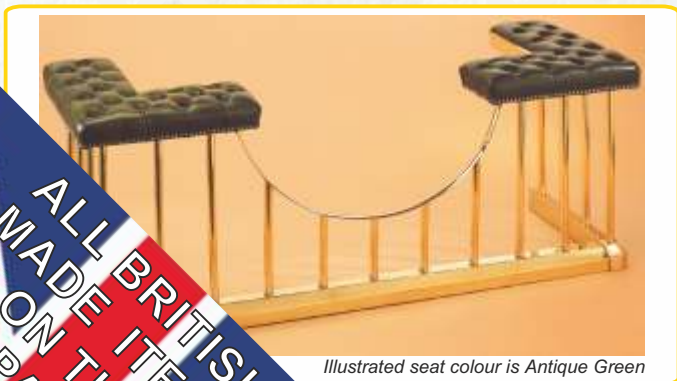

Illustrated seat colour is Antique Green

CANTERBURY MTM only,
4' (1220mm) minimum width.
3 row 'deep' buttons as standard.
BB Seat size shown approx
W6.5"H18" (165x460mm)



Illustrated seat colour is Burgundy

REGAL

Made to measure only, 5' (1525mm) minimum width.
3 row 'deep' buttons as standard. Seat size shown
approx W6.5"H20.5" (165x520mm)

ALL BRITISH
MADE ITEMS
ON THIS
PAGE

CALFIRE Fenders



British
Manufactured
Items

Hearth Fenders - All standard fenders have INTERNAL dimensions of 1220/1525 x 380mm (4/5'x15"), unless otherwise stated. We offer a bespoke service where width and depth dimensions as well as various finish options can be provided.



Sandringham Black & Brass
30025

Sandringham Brass
30015

Classic 6 Brass
30045

Classic 6 Black & Brass
30055

all items
on this page
can be made
to measure

Classic 6 Black & Silver
30065

Classic 6 Silver
30075



To ensure goods are received in perfect condition fenders on this page, apart from the Sandringham's, are supplied in 3 pieces for easy showroom or home fitting.



Spiral Black & Brass
30275

Spiral Black & Silver
30285

Spiral Black
30265

ALL BRITISH
MADE ITEMS
ON THIS
PAGE



Hearth Fenders

All standard fenders have INTERNAL dimensions of 1220/1525 x 380mm (4/5'x15"), unless otherwise stated. We offer a bespoke service where width and depth dimensions as well as various finish options can be provided.

Classic Base Brass
30035



Classic Base Black
30255



Classic Base Steel
30085



all items
on this page
can be made
to measure

To ensure goods are received in perfect condition all fenders on this page are supplied in 3 pieces for easy showroom or home fitting. Special Order Fenders can include the Regal Base shown below.

Regal Base Brass
30095



Regal Base Black
30115



Regal Base Steel
30105



CALFIRE Fenders

Hearth Fenders

Specified finishes relate to colour only and not material.

All standard fenders have INTERNAL dimensions of 1220/1525 x380mm (4/5'x15"), unless otherwise stated. The fenders offered on this page are only available in standard sizes and finishes.



Plain Base - 3 Piece



All Black
31006

6 Ball - 3 piece

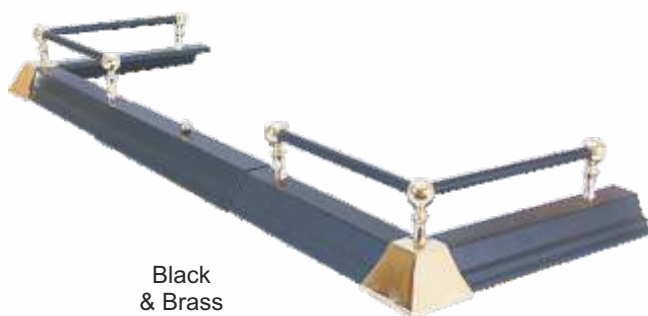

Black & Brass
31003

Spiral Twist - 3 piece



All Black
31004

Black & Satin Nickel
31007

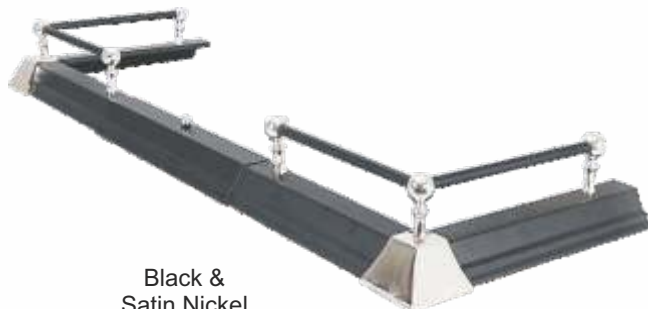

6 Urn - 3 piece



All Black
31000

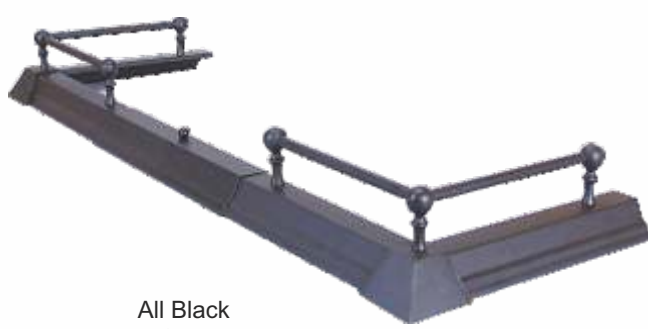

All Black
31002

The Caframo Ecofan® is a heat-powered fan designed to circulate the warm air created by a wood or gas stove. Improved warm air circulation results in greater comfort and less fuel consumption.

Why buy a Stove Fan?

- * **Costs nothing to run...** Using the heat from the stove, a Stove Fan is the most economical way to effectively circulate the warm air your stove produces. No cables, plugs or batteries are required.
- * **Cuts your fuel bills...**
- * **Increased Efficiency...** warm air is pushed out into the living area rather than just rising to the ceiling above the stove. This improves the heating effectiveness of the stove and results in greater room comfort as shown below.

* Heat distribution without an Ecofan®



* Simulation

* Heat distribution with an Ecofan®



* Simulation

Reasons to buy a Genuine Caframo Ecofan®

- * Caframo have two decades of experience perfecting the Ecofan®. **This means lower failures and higher customer satisfaction.**
- * Ecofans® are made in Canada, last longer and utilise a superior design that operates more efficiently and effectively than 3, 4 or 5 blade models.*
- * More Ecofans® have been sold than all other stove top fans combined.
- * Test results using AMCA testing standards prove that most air flow claims made by other stove top fan manufacturers are exaggerated, some by as much as 45%.*
- * **Fully CE compliant for Immunity Emissions and Product Safety**.... None of the Chinese copy stove fans meet all of these approvals despite what is printed on the boxes or their importers claims.*
- * **All Ecofans are sold with the reassurance of a 2 year warranty.**

* For current information see 'Compare Stove Fans' graphs online at www.ecofan.co.uk/compare-stove-fans or scan the QR code on the right with your smart-phone or tablet.



Which Ecofan® do you need?

If you have a wood-stove the 812 AirMax will provide the highest air flow and start working at the lowest temperature so this is the ultimate option. Alternatively the 810 UltraAir will provide slightly less air movement and start working at a slightly higher temperature but still provide excellent results. For minimal outlay opt for the basic 800 Original which will provide reduced performance but still out-perform all Chinese copy stove fans. All Ecofans are sold with the reassurance of a 2 year warranty.

The 806 BelAir is designed for use on the lower stove-top operating temperatures found on many gas, pellet or contemporary stoves and will outperform other Ecofans within its operating range.

Out Performs - Out Lasts - Out Sells					
PROVEN TESTING					
WOOD STOVES	Operating Temperature	CFM* (up to)	Fuel Saving (up to)	Feel Heat Faster**	Warranty Period
800 Original Ecofan Dimensions: Base plate 100x75mm (4x3) Height 235mm (9.25) from base to top of blade, excluding handle. Blade diameter 206mm (8)	110 - 345°C	100	12%	20%	2 Years
810 UltraAir Ecofan Dimensions: Base plate 121x76mm (4.75x3) Height 222mm (8.75) from base to top of casting, excluding handle. Blade diameter 206mm (8)	100 - 345°C	125	14%	31%	2 Years
812 AirMax Ecofan Dimensions: Base plate 121x82mm (4.75x3.25) Height 248mm (9.75) from base to top of casting, excluding handle. Blade diameter 232mm (9)	85 - 345°C	175	18%	38%	2 Years
SPECIALITY STOVES Low temperature for many gas, pellet or contemporary stoves	Operating Temperature	CFM* (up to)	Fuel Saving (up to)	Feel Heat Faster**	Warranty Period
806 BelAir Ecofan Dimensions: Base plate 162x61mm (6.4x2.4) Height 241mm (9.5) from base to top of casting, excluding handle. Blade diameter 232mm (9)	75 - 200°C	140	The 806 BelAir Ecofan outperforms the 800, 810 and 812 Ecofans in its operating temperature of 75 - 200°C. Fuel saving and feel the heat results vary depending on type/features of the speciality stove.		2 Years
*CFM cubic feet per minute of air moved					
** Time taken to reach 20°C from a cold start of 17°C in a standard test environment. Original: 87 minutes UltraAir: 76 minutes AirMax: 68 minutes No fan: 110 minutes					
All Ecofans produce a useful 50 CFM at minimum operating temperature					

Performance

The Performance Graph shows the different capabilities of the Ecofan® woodstove range. The 812 AirMax moves significantly more air than the 810 UltraAir while this unit moves significantly more than the basic 800 Original.

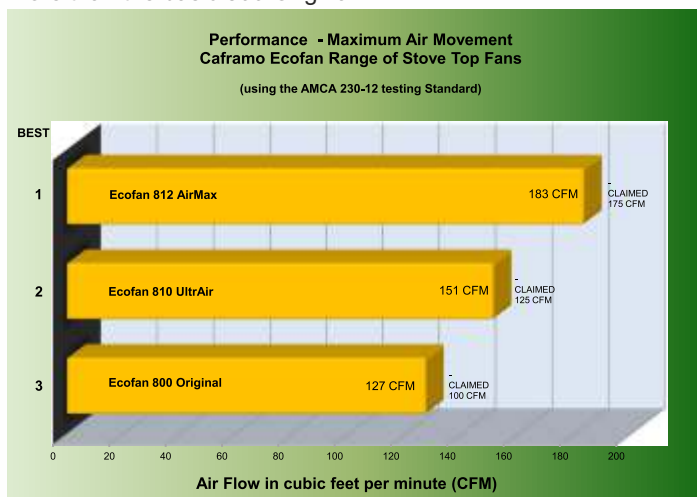

Efficiency

This graph shows the 806 BelAir to give the best performance at low temperatures while, of the woodstove fans, the best option is the 812 AirMax followed by the 810 UltraAir and then the basic 800 Original.

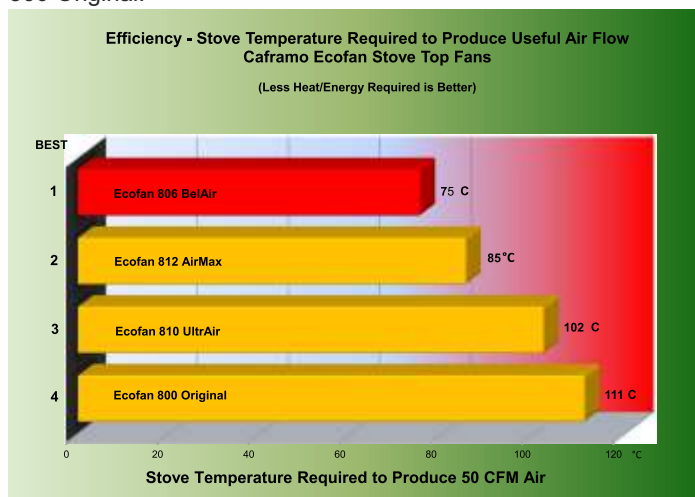

For current information see 'Compare Stove Fans' graphs online at www.ecofan.co.uk/compare-stove-fans

How to get the most from your Ecofan®

Placement of your Ecofan® on your stove top is critical. Be sure to position the Ecofan® on the stove so that cool air will be drawn over the 'cooling fins'. The Ecofan® should not be used directly in front of the stovepipe or at the front of the stove. Place the Ecofan® at the back edge of the stove as shown in the diagram. Should the gap between the rear of your stove and your wall be less than 150mm (6") then move your Ecofan® forward, along the side of your stove and turn it in slightly. This should ensure your fan can draw the necessary cooler air from the rear/side of your stove.

For product details including technical, warranty and refurbishing service, visit our product specific website at www.ecofan.co.uk or scan the QR code on the right with your smart-phone or tablet.



Ecofans are assembled in CANADA with domestic and imported parts



Ecofans fully comply with all CE Immunity Emissions and Product Safety requirements.

See page 76 for available spare parts.

It is important to read and follow the instructions on the correct placement of the Ecofan® to ensure satisfactory long term use and that your stove is working within the temperature range of 'best operation'. We recommend the use of our Stovetop Thermometer 14077; see page 85 for details.

AirMax 812 Wood-Stove Ecofan®

The Caframo AirMax Ecofan® 812 is a heat-powered fan designed to circulate the warm air created by a wood-stove operating with normal surface temperatures of between 85°C and 345°C. The AirMax Ecofan® 812 generates up to 175 Cubic Feet (of Air) per Minute. (At 85°C the AirMax Ecofan® 812 will move 50 CFM)

Dims: Base Plate W121 D82 (4.75x3.25") H248 (9.75") from base to top of blade, excluding handle. Blade diameter 232mm (9")



The AirMax 812 replaced the AirPlus Ecofan® in 2011.

Which unit do you need? See page 73 for confirmation that the 812 AirMax provides the best Performance and is the most Efficient wood-stove Ecofan®.

**Sold with a
2 year Warranty**



AirMax 812 Ecofan®
E812BB
All Black

74

AirMax 812 Ecofan®
E812BN
Black & Nickel

AirMax 812 Ecofan®
E812BG
Black & Gold

UltraAir 810 Wood-Stove Ecofan®

The Caframo UltraAir Ecofan® 810 is a heat-powered fan designed to circulate the warm air created by a wood-stove operating with surface temperatures of between 100°C and 345°C. The UltraAir 810 Ecofan® generates up to 125 Cubic Feet (of Air) per Minute. (At 100°C the UltraAir Ecofan® 810 will move 50 CFM)

Dims: Base Plate W121 D76 (4.75x3"). H222 (8.75") from base to top of casting, excluding handle. Blade diameter 206mm (8")

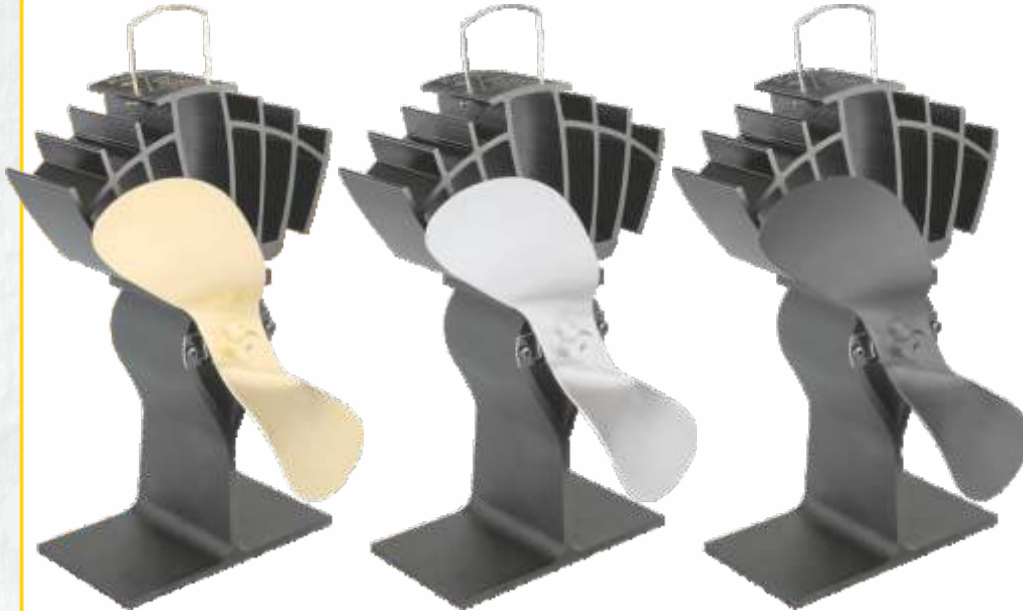

ULTRAIR Ecofan®

The UltraAir 810 replaced the Original 800 Ecofan® in 2012.

Which unit do you need? See page 73 for a list of benefits of the more Effective and Efficient 812 AirMax Ecofan®.

**Sold with a
2 year Warranty**

UltraAir 810 Ecofan®
E810BG
Black & Gold

UltraAir 810 Ecofan®
E810BN
Black & Nickel

UltraAir 810 Ecofan®
E810BB
All Black

It is important to read and follow the instructions on the correct placement of the Ecofan® to ensure satisfactory long term use and that your stove is working within the temperature range of 'best operation'. We recommend the use of our Stovetop Thermometer 14077; see page 85 for details.

Original 800 Wood-Stove Ecofan®

The Caframo Original Ecofan® 800 is a heat-powered fan designed to circulate the warm air created by a wood-stove operating with normal surface temperatures of between 110°C and 345°C. The Original Ecofan® 800 generates up to 100 Cubic Feet (of Air) per Minute. (At 110°C the Original Ecofan® 800 will move 50 CFM)

Dims: Base Plate W100 D75 (4x3"). H235 (9.25") from base to top of blade, excluding handle. Blade diameter 205mm (8")

ORIGINAL Ecofan®

The Original 800 was replaced by the UltraAir 810 Ecofan® in 2012. It was then re-introduced into the range in 2014 as an entry level unit to compete against Chinese copies of this design.

The Original 800 Ecofan® outperforms all of these Chinese copy stove fans (see page 72 for a link to the UK Ecofan® website that compares stove fan performance).

Which unit do you need? See page 73 for a list of benefits of the more Effective and Efficient 812 AirMax and 810 UltraAir Ecofan® designs.

Sold with a 2 year Warranty

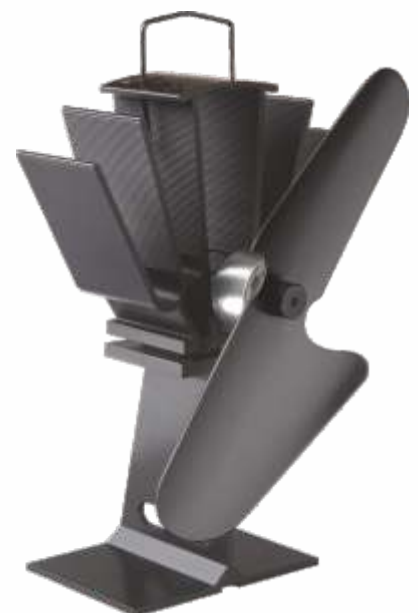

Original 800 Ecofan®
E800BB
All Black

BelAir 806 Low Temperature Stove Ecofan®

The Caframo BelAir Ecofan® 806 is a heat-powered fan designed to circulate the warm air created by many low temperature gas, pellet or contemporary stoves operating with normal surface temperatures of between 75°C and 200°C. The BelAir Ecofan® generates up to 140 Cubic Feet (of Air) per Minute. (At 75°C it will move 50 CFM). The BelAir Ecofan® must not be used on a wood-stove or where the surface temperature exceeds 200°C .

Dims: Base Plate W162 D61 (6.4x2.4"). H241 (9.5") from base to top of blade. Blade diameter 232mm (9")



BelAir Ecofan®

The BelAir 806 replaced the 806GS Ecofan® in 2013.

The BelAir outperforms all other Ecofans® in its operating range of 75 - 200°C but should never be used on a wood-stove.

**Sold with a
2 year Warranty**

BelAir 806 Ecofan®
E806BG
Black & Gold

BelAir 806 Ecofan®
E806BN
Black & Nickel

BelAir 806 Ecofan®
E806BB
All Black

Spare Parts for Ecofans®

Replacement Motor Kits are available for the Ecofans® as detailed below. Unfortunately we are unable to offer for sale thermo-electric modules as their replacement is a controlled process involving strict torque settings. If you believe the module has failed you are welcome to send your Ecofan® to CALFIRE who will quote you accordingly. Please note that we will only sell Ecofan® spare parts for use on original Ecofans®; not for any other purpose.

Motor Replacement Kits

After much usage an Ecofan® motor can wear out. Motor Replacement Kits are available for customers who wish to install a new motor rather than sending the old unit back to CALFIRE for repair, or purchasing a new Ecofan®. The replacement task is straight forward; however on some older models the consumer must have the capability to solder the new motor to the existing wires. The replacement kit comprises a new motor, an Allen/hex key to remove the blade and full instructions.

* To see how easy it is to change the motor on the 810 or 812 Ecofans® view the video online at www.ecofan.co.uk/812

or scan the QR code below with your smart-phone or tablet.



- ES006 800 Original, 802 AirPlus or 806GS (Soldering & Push-On Type)
- ES009 810 UltraAir, 812 AirMax (Push-On Type Only)
- ES017 806 BelAir (2014 Model - Push-On Type Only)





Stove Bright® Paint - UK website www.stovebright.co.uk



Colour Charts are available on request

Stove Bright® High Temperature Paint

Stove Bright High Temperature Paint is a high quality, fast drying, high temperature paint for use on wood stoves, pipes, boilers, furnaces, flue pipes, ovens, engines, manifolds, barbecues and cast iron chimineas etc. It can be used on any steel product with extreme surface temperatures up to 650°C and is ideal for touching up ceramic coals. Unique in offering 3 'blacks' and a range of over 30 colours, Stove Bright is used by many of the leading stove manufacturers as their factory finish.

HTP AEROSOL CODES:

- 04001 FLAT BLACK
- 04002 SATIN BLACK
- 04003 CHARCOAL
- 04004 METALLIC BLACK
- 04005 METALLIC BROWN
- 04006 GOLDENFIRE BROWN
- 04007 HONEY-GLO BROWN
- 04008 METALLIC MOSS GREEN
- 04009 FORREST GREEN
- 04010 REDWOOD
- 04011 ALMOND
- 04012 METALLIC BLUE
- 04013 METALLIC GREY
- 04014 MAUVE
- 04015 GOLD
- 04016 RUSSET
- 04017 SAND
- 04018 MOJAVE RED
- 04019 SKY BLUE
- 04020 SILVER (ALUMINIUM)
- 04021 METALLIC MAHOGANY
- 04022 BROWN BARK
- 04023 PATRIOT BLUE
- 04024 METALLIC RICH BROWN
- 04025 METALLIC RED PRIMER
- 04026 MED TEMP CLEAR
- 04027 COPPER
- 04028 GREEN ILLUSION
- 04029 TERRA COTTA
- 04030 SHIMMERING ROSE
- 04031 SUNSET
- 04032 SURF SAND
- 04033 PEWTER
- 04034 EMERALD GREEN
- 04036 ADOBE TAN
- 04037 LEATHER BROWN
- 04038 NEW BRONZE

HTP 236ml (½ US Pint)

TOUCH-UP CODES:

- 05101 FLAT BLACK
- 05102 SATIN BLACK
- 05103 METALLIC BLACK

Stove Bright® Gas Vent Pipe Paint

Stove Bright Gas Vent Pipe Paint can be used on Double Wall Flue Pipe to match Vitreous Enamel Finishes. This is a high gloss coating capable of withstanding surface temperatures to 120°C. It is fast drying and easy to apply.

GAS VENT PIPE PAINT AEROSOL CODE:

- 04101 BLACK EBONY

Aerosol Can Gun



Firmly snaps onto aerosol to provide greater and more comfortable spray control

04051
AEROSOL CAN GUN

Contact our Sales Office on 01691-772922 for details of Stove Bright 'Ready to Use' availability.

CALFIRE Stove Glass & Mica

Stove Glass Panels, Strips & Mica



CALFIRE STOCK SIZES FOR ALL POPULAR STOVE MANUFACTURERS

Panels

Calfire Panels are manufactured from the finest quality Schott Robax® zero thermal expansion rated ceramic glass. Sizes are available from stock for all leading stoves and our in-house cutting facility means any size and shape can be quickly supplied to order.

Strips

Replacement Strips are supplied from the highest quality flat borofloat sheet. Calfire have Strips to suit the majority of stoves on the market and can supply specials with a rapid response guaranteed.

Mica

Ready cut stove panels and standard sheets are available

**SCHOTT
ROBAX®**



CALFIRE
The Fireside Collection



**We recommend
when replacing new
glass panels to also
replace the thermal
rope seal.**

**Please refer to pages
79-80**



Glass panels, glass strips and mica are supplied skin packed to display on euro-hooks. All size information provided in good faith, please ensure correct requirements are specified.

Please contact us for prices on any special sizes. See Stove Glass & Mica Price List for details.

CALFIRE Stove Glass Rope

Panel Replacement Accessories

Calfire thermal rope seal is fitted to stove and oven doors to provide an air tight seal.
Secure with Calfire Super Seal.

WHITE THERMAL ROPE SEAL

Supplied in 2 metre packs or 25 metre rolls with thicknesses ranging from 3mm to 25mm. Please note that 2 metre packs with an 'S' suffix include a 30ml Calfire Superseal & strip of end sealing tape.



SOFT BLACK THERMAL ROPE SEAL

Supplied in 2 metre packs or 25 metre rolls with thicknesses ranging from 6mm to 14mm. Please note that 2 metre packs with an 'S' suffix include a 30ml Calfire Superseal & strip of end sealing tape.



BLACK THERMAL ROPE SEAL

Supplied in 2 metre packs or 25 metre rolls with thicknesses ranging from 6mm to 12mm. Please note that 2 metre packs with an 'S' suffix include a 30ml Calfire Superseal & strip of end sealing tape.



	3mm	6mm	8mm	9mm	10mm	12mm	14mm	15mm	18mm	25mm
White 2M Pack	10002S	10006S	10010S	N/A	10014S	10018S	N/A	10022S	10026	10030
White 10M Pack	N/A	N/A	N/A	N/A	N/A	N/A	N/A	N/A	N/A	10032
White 25M Roll	10004	10008	10012	N/A	10016	10020	N/A	10024	10028	10033
Black 2M Pack	N/A	10035S	10039S	10058S	10043S	10047S	N/A	N/A	N/A	N/A
Black 25M Roll	N/A	10037	10041	10059	10045	10049	N/A	N/A	N/A	N/A
Black Soft 2M Pack	N/A	10050S	10052S	N/A	10054S	10056S	10061S	N/A	N/A	N/A
Black Soft 25M Roll	N/A	10051	10053	N/A	10055	10057	10060	N/A	N/A	N/A

PART NUMBERS WITH AN 'S' SUFFIX INCLUDE 30ml CALFIRE SUPERSEAL & STRIP OF END SEALING TAPE

A high temperature adhesive that withstands very high temperatures and is used to secure thermal rope/tape and ceramic fibre seal



CALFIRE SUPERSEAL

13001 30ml
13002 100ml
13003 500ml

Tape which prevents thermal rope ends fraying.



THERMAL ROPE END SEALING TAPE

10601 White
10602 Black
25mm x 10M Roll

CALFIRE Stove Glass Rope

Panel Replacement Accessories

*Calfire thermal rope seal is fitted to stove and oven doors to provide an air tight seal.
Secure with Calfire Super Seal.*



WHITE THERMAL TAPE

Calfire thermal tape has many uses on a wide range of heating appliances. Secure with Calfire Superseal.

- 10510** - 40mm x 2mm x 2 metres
- 10512** - 40mm x 2mm x 25 metres



WHITE ADHESIVE THERMAL TAPE

Calfire thermal tape has many uses on a wide range of heating appliances and is self adhesive.

- 10518** - 15mm x 2mm x 2 metre reel
- 10520** - 15mm x 2mm x 25 metre reel
- 10526** - 25mm x 2mm x 2 metre reel
- 10528** - 25mm x 2mm x 25 metre reel



WHITE THERMAL LADDER TAPE

Calfire ladder tape is used for protecting the edges of glass panels.

- 10562** - 25mm x 3mm x 2 metres
- 10564** - 25mm x 3mm x 25 metres



BLACK ADHESIVE THERMAL TAPE

Calfire thermal tape has many uses on a wide range of heating appliances and is self adhesive.

- 10542** - 10mm x 2mm x 2 metre reel
- 10544** - 10mm x 2mm x 25 metre reel
- 10546** - 15mm x 2mm x 2 metre reel
- 10548** - 15mm x 2mm x 25 metre reel



BLACK ADHESIVE THERMAL LADDER TAPE

Calfire ladder tape is used for protecting the edges of glass panels. This is an alternative to the ceramic Channelling Calfire sold for many years.

- 10565** - 17mm x 2mm x 2 metres
- 10566** - 17mm x 2mm x 25 metres



BLACK OVER BRAID THERMAL ROPE

Calfire over braid thermal rope is fitted to stove doors for an airtight seal. Secure with Calfire Superseal.

- 10063S** - 13mm x 2 metres
- 10062** - 13mm x 25 metres



BLACK P SECTION BEAD

Calfire P section bead is used to create an airtight stove glass seal on specific stoves.

- 10567** - 10mm x 15mm tail x 0.5 metres



CERAMIC FIBRE SEAL

This is used on many stoves to provide an air tight seal to the stove glass panels. Secure with Calfire SuperSeal.

- 14028** - 6mm x 4mm x 10 metres
- 14031** - 10mm x 4mm x 10 metres



Glass Hearths

Quality British Made Glass Hearthplate
manufactured in 12 mm toughened float glass
and supplied with polished edges.

Square Glass
Hearthplate

14145
900mm x 900mm Clear

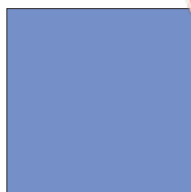

Rectangular
Glass Hearthplate

14146
1100mm x 850mm Clear



'D' Shaped
Glass Hearthplate

14147
1100mm x 850mm Clear

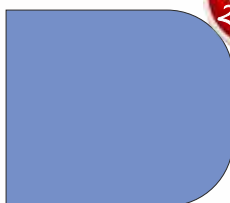

Circular Glass
Hearthplate

14148
Dia.1100mm Clear

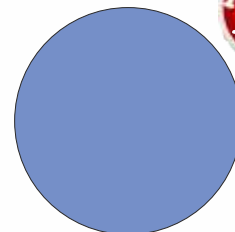

Truncated
Circular Glass
Hearthplate

14149
1100mm x 950mm Clear

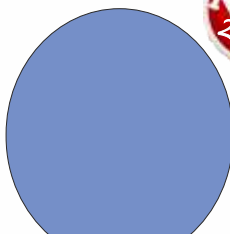

Teardrop Glass
Hearthplate

14150
1100mm x 1100mm Clear



Bespoke Glass Hearthplate

We can cut and colour any
size of hearthplate. Send Calfire
the measurements and RAL
number for a quote today.

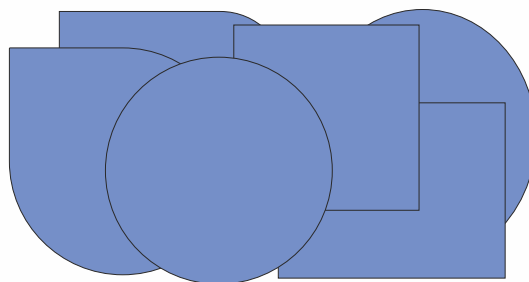

Glass Hearthplates are just as much a feature in the room as the stove itself. Compliment your woodburner or electric stove with a fashionable quality British Manufactured product. Easy to clean and Heat Resistant floor covering.



Mini EuroCowl Static Anti-Downdraught Cowl

Designed to cure smoky fireplaces. Prevents down-draughts by creating a positive airflow whatever the wind direction. Fits flue sizes 125mm to 250mm internal diameter. Also prevents birds, vermin and rain entry. Suitable for all fuels. Supplied fully assembled and ready to fit. Maintenance: High dome allows for effective sweeping in situ. Approvals: BS/EN 1856-1 2009.



Mini EuroCowl Terracotta
14087 Stainless Steel

Mini EuroCowl Natural
14089 Stainless Steel

Mini EuroCowl Black
14090 Stainless Steel

MAD Junior Cowl Stainless Steel

Durable stainless steel anti down draft chimney cowl suitable for all fuel types. This competitively priced high quality anti down draught chimney cowl allows for a quick installation. The aerodynamic shape of the junior cowl reduces problems caused by down draught whilst also minimising rain entry. Sold Fully assembled ready to fit. No special tools required when fitting. Junior Stainless steel is suitable for use with coal, wood, gas, smokeless fuel and oil. Includes Mesh Birdguard which will need to be removed for solid fuel applications. Will fit chimney pots up to 275mm. Test certified to BSEN 1856-1:20003. Available in Natural, Terracotta and Black. Stainless steel hose clip strap fixing kit included.

MAD
Junior Cowl
S.STEEL
14122
Black



MAD
Junior Cowl
S.STEEL
14121
Terracotta



MAD
Junior Cowl
S.STEEL
14120
Natural



MAD Rain Cowl Stainless Steel

The all stainless steel rain cowl is designed to prevent unwanted bird and animal entry, and to reduce the potential of clogging caused by soot or debris. The tall construction and domed lid allows a sweeping brush to get right into the cowl, whilst the stainless steel construction allows for a longer lasting birdguard. Suitable for coal, wood, oil and smokeless fuel. Suitable for chimney pots up to 250mm. Prevents birds and helps minimise rain entry. Available in Natural, Terracotta and Black. Stainless steel hose clip strap included.

MAD
Rain Cowl
S.STEEL
14125
Black



MAD
Rain Cowl
S.STEEL
14124
Terracotta



MAD
Rain Cowl
S.STEEL
14123
Natural



MAD Junior Birdguard, Stainless Steel

The nuisance caused by birds, small animals and debris can be negated by fitting this cowl. Suitable for coal, wood, smokeless fuel and oil. Made completely from stainless steel allows for an extended working life of the product. Suitable for chimney pots up to 250mm. Available in Terracotta. Prevents birds and helps minimise rain entry. Stainless steel hose clip strap included.



MAD Junior Birdguard, SS
14126 Terracotta



CALFIRE Service & Installation

Fire Cements & Compounds



Mouldable Firebrick

For quick and economical repairs or replacements for firebricks in any heating appliance, stove, open fire, wood burner etc. Tested to 1600°C

12021 5Kg.



Premium Fire Cement

A range of premium ready mixed fire cement. Ideal for patching and repairs to firebricks, fireplaces, solid fuel ovens, boilers and central heating systems. Tested to 1250°C

BUFF: BLACK:
12001 500g 12008
12002 1Kg 12009
12003 2Kg 12010
12025 5Kg 12026

BLACK CARTRIDGE
12007 300ml



C H System Inhibitor

Central Heating System Inhibitor is a multi-purpose treatment, specially designed to protect the entire central heating system from scale, sludge and corrosion.

13026 1L



Heat Resistant Tile Adhesive

Ready-mixed adhesive for fixing tiles in areas subject to high temperatures, such as fire surrounds, behind boilers, cookers and radiators. Resistant to 1000°C.

12023 300ml CARTRIDGE



Heat Resistant Sealant

A ready mixed high temperature sealing and caulking paste for use in fixing and jointing as well as for fire protection. Will withstand up to 1250°C.

BEIGE:
12027 300ml Cartridge



Heat Resistant Silicone

Providing excellent adhesion to most building materials this product is specifically designed and recommended for high temperature applications up to 300°C.

BLACK:
12024 310ml Cartridge



Heat Resistant Silicone 300C

High performance permanently flexible silicone sealant for all high temperature requirements. Heat resistant to 1200°C, does not harden or crack like fire cement. **This product should not be used near naked flames or hot gases.**

BLACK:
12028 310ml Cartridge

Gas Fire Spares - Ceramics



GAS EMBER PACK
14113 250g



MOULDED
COALS SMALL
14049 (BAG15)
14047 SINGLE



MOULDED
COALS LARGE
14050 (BAG10)
14048 SINGLE



RIPPED
COALS SMALL
14043 (BAG15)
14041 SINGLE



RIPPED
COALS LARGE
14044 (BAG10)
14042 SINGLE

Wall Vent



CORE DRILL
WALL VENT
14112

Brown External Cowl, 125mm (5") Diameter.
300-380mm (12-15") Tube Length
Free Area cm² - 100cm²
Rated Output - 27kW

To supply high levels of combustion/cooling
air for heating appliances.

Special features include:

- * Draught resistant cowl
- * Free area reducer disk
- * 50mm long spigot and large flanges for 'Easyfit'
- * Removable internal inspection/directional louvre

Flue Brushes



FLUE BRUSHES:

- 14008 L3'Dia.2"(915x50mm) GUMATI
- 14010 L3'Dia.4"(915x100mm) GUMATI
- 14011 L4'Dia.4"(1220x100mm) GUMATI
- 14012 L5'Dia.4"(1525x100mm) GUMATI

Heat Resistant Gloves



HEAT RESISTANT GLOVES
14080

Red Lined Gauntlet. Category 2 - Intermediate design.
Manufactured to EN388 & EN407

Smoke Products & CO Detector



SMOKE PEN

14118 SMOKE PEN WITH 3 SMOKE STICKS

14119 SMOKE STICK REFILL PACK



CO DETECTOR

14070 SINGLE PACK



SMOKE MATCHES
14001 CLASSIC
(BOX12)

- SMOKE PELLETS
- 14002 13g (TUBE6)
 - 14061 5g (TUBE6)
 - 14064 13g (TUB50)
 - 14062 5g (TUB50)
 - 14065 13g (TUB100)
 - 14063 5g (TUB100)

See price list for full details

Digital Moisture Meter



14116 CALFIRE DIGITAL MOISTURE METER
(80x40X20mm) (3.1x1.6x0.75")

This instrument can be used to measure the moisture level in sawn timber and hardened materials such as mortar, concrete and plaster as well as the environmental temperature. Small enough to comfortably slip into your pocket the backlight turns off automatically after around 15 seconds to conserve the supplied batteries. With a wood measurement range of 6 – 42% and an accuracy of +/- 2%, this unit is ideal for checking your wood is well seasoned at the recommended level of around 20%.

FiAir Air Blower



14129 FiAir AIR BLOWER

The FiAir is a hand held battery powered fan used to speed up the blaze of your open fire, stove or barbeque. Now a cozy fireside is just two minutes away as the FiAir kindles wood to a robust blaze in two minutes or less and keeps it that way with a few well-placed bursts of life-giving air each time you add more fuel. This compact, portable, hand-held device uses 3 x AAA batteries (not included)

For more information visit www.fiair.net

Stove Thermometers



CALFIRE MAGNETIC STOVEPIPE THERMOMETER
14024
Dia.63 (2.5")

Ensure your stove is operating at the correct temperature by using this magnetic thermometer that attaches to your stove pipe. If your stove is too cold then creosote deposits will form, if its too hot then you are wasting both energy and money.

The CALFIRE Stovepipe Thermometer is NOT designed or calibrated for the hotter surfaces of your stovetop.



MAGNETIC STOVETOP THERMOMETER
14077
Dia.63 (2.5")

Ensure your stove is operating at the correct temperature by using this magnetic thermometer that sits on your stovetop. If your stove is too cold then creosote deposits will form, if its too hot then you are wasting both energy and money. The white area shows the optimal stove operating temperature. This unit is not calibrated for use on your Stovepipe.

Carbon Monoxide Alarms

Defend against the Silent Killer. No smell, No taste and No colour. It is for these reasons that CO detectors are the only way to alert you to increasingly dangerous levels of Carbon Monoxide.

Effects of CO: Exposure to high levels of carbon monoxide (CO) can be fatal or cause permanent damage and disabilities. Many cases of reported carbon monoxide poisoning indicate that whilst victims are aware they are not well, they become so disorientated that they are unable to save themselves by either exiting the building, or calling for assistance. Young children and household pets may be the first victims.

Possible sources of CO include: Faulty Boilers - Gas Ranges/Stoves - Water Heaters - Portable Fuel Burning Heaters - Fireplaces - Wood-Burning Stoves - Blocked Chimneys or Flues - Vehicles and other combustion engines running in an attached garage could also be the source of CO



14082 SLEEPSAFE SEALED BATTERY CO ALARM COA2

Certified to EN50291-1:2010 - Sealed for life battery - Loud audio alert - 3 LED visual readouts - Test / Silent button - Portable, free standing or mountable - 6 year operating life.



14117 SLEEPSAFE DUAL CO & SMOKE ALARM COS1

2-in-1 alarm tests for both Carbon Monoxide and Smoke. Operates on a 9v battery (inc) - 2 loud audio alerts - 2 LED visual readouts - Individual Smoke & CO test buttons - 6 year operating life.



When connected to a vacuum cleaner the Karcher Ash Filter provides trouble-free cleaning of fireplaces, wood-burning stoves, barbecues & sauna ovens. Also suitable for picking up coarse dirt and debris, e.g. sand or sawdust. Suitable for use with most domestic vacuum cleaners, however you must use a wet & dry machine if you want to pick up wet leaves etc...



14081 KARCHER ASH FILTER

Chimney Rods & Brushes

Vermiculite Boards

Soft bristle brush with protected end boss and Whitworth 1/2" male end screw fitting. Designed for sweeping insulated metal chimneys and flexible flue liners with our flexible rods where greater flexibility is needed to cope with bends. This can be used with the 1/2 inch to 3/4 inch connector.

SOFT BRISTLE BRUSH
 14133 5"/125mm Brush White
 14134 6"/150mm Brush White

Affordable flexible rods made in Britain using "Superflexy" 12mm diameter rod for added strength and durability. The rods have a high quality brass screw end with 1/2" Whitworth screw fitting featuring chamfered edges to minimise risk of damaging any flexible liners.

FLEXIBLE RODS
 14135 1 Metre Rod
 14136 2 Metre Rod

BRASS ROD ADAPTOR
 14137
 1/2" Whitworth to
 Universal 3/4"



Board made from Exfoliated Vermiculite and has a high temperature resistance suitable for hotface applications up to 1100°C. The boards are easily cut to size with woodworking tools, the linings contain no ceramic or Asbestos fibres are non-dusting, non-irritant and odourless.



BRICKETT
 14139
 H610 W997 D20



ANTIQUE BRICK
 14140
 H610 W997 D20



BRICK
 14141
 H610 W997 D20



REEDED
 14142
 H610 W997 D20



PLAIN
 14138
 H1000 W610 D25



Firelighters

Firebuilder® - All-in-one Firelighter NEEDS NO KINDLING

Firebuilder® is quick to ignite and creates a hotter, fuller fire than any other product on the market. Through its comprehensive scientific research and testing, it has reduced the time it takes the fire to reach 1kw of heat from 42 minutes to 27 minutes. This has been regarded as a scientific breakthrough in the fire lighting sector. Results are based on the industry standard test used for all firelighters and approved by HETAS.

Features and Benefits

- Produces a faster, fuller fire
- Firebuilder® contains no kerosene
- Simple to use & easy to light
- Firelighter & kindling in one
 - No Mess
 - Odourless



Pack quantity 5 blocks, this can start up to 10 fires

14131 FIREBUILDER

Strikeable Firestarters

The 2 in 1 Safety match and Firestarter. Ideal for Stoves, Open fires, BBQ's and Chimineas. Burning time over 10 Minutes, clean to use.



Pack quantity 20

14143 FIRESTARTERS

CALFIRE

Cleaning & Restoration

Cleaning & Restoration Products



A blend of detergents and solvents in a foaming aerosol formula, which removes grease and dirt from all types of surfaces with its amazing cleaning power.

PEEK SPRAY-AWAY
13603
400ml aerosol

Peek



PEEK CREAM POLISH - 250ml tin
13601



PEEK CREAM POLISH - 100ml tube
13600

Developed for professionals and demanded by those who have tried it, Peek is a 4-in-1 cleaner that cleans, polishes, restores and protects 38 surfaces including brass, copper, stainless steel, silver, gold, chrome, fibreglass, ceramics, glass, acrylics and painted surfaces. When The Royal Yacht Britannia was in service everything on board, from the Royal George Binnacle to each piece of silver, was kept in pristine condition by the Yachtsmen using Peek Polish. This resulted in the products manufacturer being awarded the Royal Warrant in 2005.

SCHOTT ROBAX®

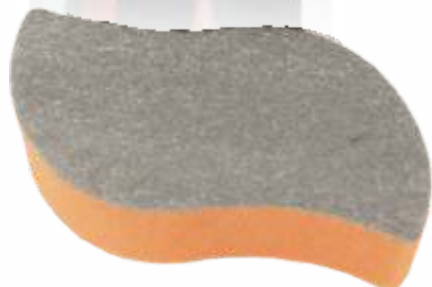

A dry glass cleaner specifically developed by Schott Robax® for cleaning glass ceramic panels.

DRY WIPER
13605

CALFIRE



STOVE GLASS
BRUSH-ON
CLEANING GEL
13028 250ml

Removes the toughest tar, soot and creosote stains from stove window glass.



STOVE GLASS
CLEANING WIPES
13029
50 Wipes

Used regularly these cleaning wipes will help to keep your stove windows clear.



STOVE GLASS
CLEANER
13009
500ml

Removes the toughest tar, soot and creosote stains from stove window glass



SPRAY ON STOVE
GLASS CLEANER
13011
500ml

Removes the toughest tar, soot and creosote stains from stove window glass.



V. ENAMEL CLEANER
13007 500ml
Removes the toughest burnt on stains from vitreous enamelled surfaces.



SLATE SHEEN
13017 500ml

Seals and protects slate, enhancing its natural beauty, repelling dirt and water whilst allowing the slate to breathe



FIREPLACE
CLEANER
13012 500ml

Removes stains from Stone, Brick and Concrete.

CALFIRE Cleaning & Restoration

Cleaning & Restoration Products



A water based graphite polish suitable for wood/coal stoves, grates and surrounds.

BLACK STOVE & GRATE POLISH
13504 170g



A very effective polish for use on copper, brass, nickel, pewter, chrome and gold. Multi-use metal polish gives a cleaner, more protective, longer lasting shine.

MULTI-USE METAL POLISH
13512 150ml tube



A water based graphite polish suitable for wood/coal stoves, grates and surrounds.

BLACK STOVE & GRATE POLISH
13503 75ml tube



A foaming formula that will stick to vertical surfaces to dissolve smoke stains and tar/creosote deposits.

GLASS CLEANER
13506 320ml aerosol



This cleaner clings to vertical surfaces to dissolve smoke stains and tar/creosote deposits.

GLASS CLEANER
13517 750ml spray



Uses an oxygen based bleaching action to remove smoke, soot and tar stains from stone, concrete, marble and other hard surfaces.

FIREPLACE CLEANER
13510 500ml



A special formulation that makes the surface of natural brick and stone strongly repellent to oil, water dirt and dust.

BRICK & STONE SEALER
13511 500ml

New Improved Product



Seals and protects slate, enhancing its natural beauty, repelling dirt and water whilst allowing the slate to breathe.

SLATE OIL
13515 100ml



Developed in Italy, this product is for polishing worn and dull marble surfaces. (non abrasive)

ITALIAN MARBLE POLISH
13513 200ml



An ultra high temperature paint specially formulated for applying a decorative finish to new, or for rejuvenating old, ceramic coals used in gas fires. Coal Paint is colour fast to 650°C.

COAL PAINT
13516 300ml

New Improved Product



Flue Free helps to maintain clean chimneys for maximum efficiency, lower fuel costs and a reduced risk of fire. Now non corrosive to stainless steel.

FLUE FREE CHIMNEY CLEANER
13500 750g