

Datalogger Thermometer TC0520

Instruction Manual



**Perfect
Prime**

www.perfectprime.com



CONTENTS

1. General Description	2
2. Safety Information	2
3. Features	3
4. Specifications	4 - 5
5. Symbol Definition and Button Location	6 - 7
6. Button Instructions	8 - 10
6.1 Power ON/OFF button	8
6.2 Backlight button	8
6.3 Data-Hold button	8
6.4 REC button	8
6.5 MEM button	9
6.6 RECALL Saved Reading Button	9
6.7 MAX/MIN/AVG Button	9
6.8 Selecting Temperature Units	10
6.9 SETUP Button	10
7. Operating Instructions	11 - 16
7.1 Setup Options	11
7.2 Menu Item	11
7.3 Menu Description	12
7.3.2 Select thermocouple type	12
7.3.3 Setting interval time for data storing	13
7.3.4 Set offset to compensate for probe errors	13
7.3.5 Set alarm point (only for channel T1)	14
7.3.6 Set T1-T2 subtraction mode	14
7.3.7 Set auto power off time	15
7.3.8 Set system clock	15
7.4 Clearing Data Logger Records	16
7.5 Clearing Instant Read-out Memory	16
7.6 Connecting To A computer	16
8. Power Operation	17
8.1 Battery Replacement	17
9. Maintenance	18
10. Testlink SE-520 Software and Download the Protocol	19 - 28



1. GENERAL DESCRIPTION/ 2. SAFETY INFORMATION

GENERAL DESCRIPTION

Thank you for choosing our data logger thermometer. To ensure the safety and the best performance of this instrument, we recommend you to read and follow the manual carefully before operation. Data can be stored in the meter or directly saved on a computer through PC interface. Recorded data can be further processed by PC computer.

IMPORTANT INFORMATION

Date and Time must be set correctly for the data logger function to work.

SAFETY INFORMATION

Read the following safety information carefully before attempting to operate or service the meter. Use the meter only as specified in this manual; otherwise, the protection provided by the meter may be impaired.

ENVIRONMENT CONDITIONS

- Altitude up to 2000 meters
- Relatively humidity: 90% max
- Operation ambient temperature: 0°C to 50°C

MAINTENANCE & CLEARING

- Repairs or servicing not covered in this manual should only be performed by qualified personnel.
- Periodically wipe the case with a dry cloth. Do not use abrasives or solvents on this instrument.



3. FEATURES

SAFETY SYMBOLS

CE Comply with EMC
When servicing, use only specified replacement parts.

- Four-channel inputs
- Support K, J, E, T type thermocouple
- Temperature alarm function
- Fast response and sampling rate
- 16,000 data logger records each channel
- Instant recall function
- USB PC interface with Windows software included
- Adjustable auto power off timer



4. SPECIFICATIONS

Measurement range

K: -200°C ~1372°C (- 328°F ~ 2501°F)
J: -200°C~1000°C (- 328°F ~ 1832°F)
E: -200°C~750°C (- 328°F ~ 1382°F)
T: -200°C~400°C (-328 °F ~ 752°F)

Resolution

0.1°C < 600°C / 0.1°F < 1000°F,
1°C ≥ 600°C / 1°F ≥1000°F

Accuracy

Accuracy is specified for ambient temperatures between 18°C (64°F) and 28°C (82°F). The specifications do not include thermocouple sensor error.
±(0.1% of reading+0.7°C) ±(0.1% of reading+1.4°F)
below -100°C (-148°F)
±(0.4% of reading +0.7°C) ±(0.4% of reading +1.4°F)

Temperature coefficient

0.01% of reading + 0.05°C per °C (<18°C or >28°C)



4. SPECIFICATIONS

Sample rate	1 time per second
Battery type	UM-4 or AAA 1.5V battery x 4
Battery lifetime	Approx. 100 hours (alkaline battery)
Operation temperature	0°C to 50°C (32°F to 122°F)
Operation humidity	10 to 90%RH (no condensing)
Storage temperature	-20°C to 60°C (-4°F to 140°F)
Storage humidity	10 to 75%RH
Dimensions/ Weight	187mm(L) × 75mm(W) × 29mm(H)/ Approx. 290g
Standard Accessories	Instruction manual, battery 1.5V AAA x 4 pcs, Windows software, micro USB cable, K type bead prob x 2 pcs, carrying case.



5. SYMBOL DEFINITION & BUTTON LOCATION

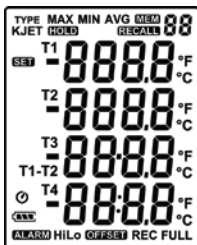

	Battery condition indicator
MIN	Minimum indicator
MAX	Maximum indicator
AVG	Average indicator
SET	Setup option indicator
	Auto Power Off enabled indicator
REC	Recording data logger indicator
FULL	Memory full indicator
MEM 88	Memory group indicator
RECALL 88	Recall Memory group reading indicator
TYPE KJET	Thermocouple type
-8888	Temperature reading
T1 T2 T3 T4	Temperature channel
T1-T2	Temperature subtraction mode
ALARM	Temperature alarm indicator
Hi	Hi Temperature alarm indicator
Lo	Lo Temperature alarm indicator
OFFSET	Compensate for probe errors
°C °F	Temperature measurement units
HOLD	Data hold indication)

5. SYMBOL DEFINITION & BUTTON LOCATION

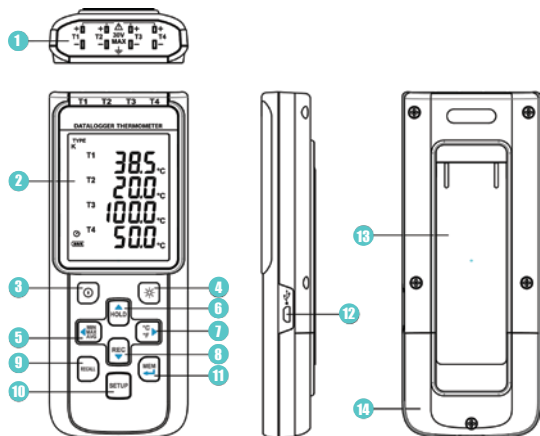



- | | |
|------------------------|-------------------------------|
| ① Thermocouple Input | ⑧ REC Button |
| ② Display Screen | ⑨ RECALL Saved Reading Button |
| ③ Power ON/OFF Button) | ⑩ SETUP Button |
| ④ Back Light Button | ⑪ MEM Button (Set 100 Memory) |
| ⑤ MAX MIN AVG Button | ⑫ USB Interface |
| ⑥ DATA HOLD Button | ⑬ Tilt Stand |
| ⑦ °C , °F Button | ⑭ Battery Compartment |



6. BUTTON INSTRUCTIONS

6.1 Power ON/OFF Button:

Press the  button to turn on the meter. Press and hold  button for 3 seconds to turn off.

6.2 Backlight Button:



Press  to turn on the LCD backlight. This makes it easier to read in dark environment. Press  again to turn off backlight. The backlight will be automatically turned off after 30 seconds to save battery power.



6.3 Data-Hold Button :

Press  button to freeze the data shown on the LCD screen. Press it again to exit Data-Hold mode.

Note: When the unit is in the Data-Hold mode, , , , and  buttons are disabled.

6.4 REC Button:

Press  button to start recording data. The "REC" symbol will display on the screen. To stop recording, press  button again.

Note: During recording period, most of the buttons are disabled, such as the , . All settings must be made before starting the data logger function.

Note: When the memory is full (32,000 recorders), "FULL" symbol will blink on the LCD screen. The data logger stops.

Note: When battery power is low ("  " symbol lights up on the screen), data logger cannot be started. If the battery is running low during data logging, it will stop recording automatically.

6. BUTTON INSTRUCTIONS

6.5 MEM Button:

Press button to save readings on the LCD screen. The “**MEM 88**” symbol lights up on the screen for 2 seconds. Press the button again to store next group readings. The store readings on the LCD screen for 00~99 group.

6.6 RECALL Saved Reading Button:

Press the button to recall saved readings. The “**RECALL 88**” symbol lights up on the screen.

Note: When the meter is during connection section, this function is disabled. Press the , , , or button to select MEM group. The LCD shows “**hour:minute:second**” on the screen for 2 seconds, and then shows the readings. Press or button to exit RECALL mode.

6.7 MAX/MIN/AVG Button:

Under this mode, the unit simultaneously monitors and stores the maximum, minimum and average value in the memory. The unit will keep updating/refreshing the data.

To start:

1. Press button. “**MAX**” symbol lights up on LCD, the reading shows the maximum data.
2. Press button again to show minimum data; the “**MIN**” symbol lights up on LCD.
3. Press button again to show average data; the “**AVG**” symbol lights up on LCD.
4. Press button again, the “**MAX, MIN and AVG**” symbol blinks together, the readings shows real time data.



6. BUTTON INSTRUCTIONS



To exit MAX/MIN/AVG mode:

Press  and hold button for 2 seconds to exit MAX/MIN/AVG mode.

6.8 Selecting Temperature Units:

Press the  button to switch between Celsius (°C) and Fahrenheit (°F).

6.9 SETUP Button:

Press the  button to enter setup options. Press  again to exit setup mode anytime.

Note: When the meter is during connection section, setup options cannot be entered.

7.1 Setup Options:

1. Press the button to enter setup options. Press it again to exit anytime.
2. Using the , , , button to adjust parameters or move setting items.
3. Press the button to save changes and move to next setting option.

7.2 Menu Item:

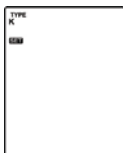

1. Fig.1 Set thermocouple type.



2. Fig.2 Set interval time for data logging.

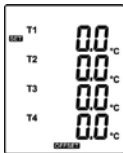

3. Fig.3 Set offset to compensate for probe errors.



4. Fig.4 Set alarm point.



5. Fig.5 Set T1-T2 subtraction mode.



6. Fig.6 Set auto power off time.



7. Fig.7 Set system clock.

7.3 Menu Description:

7.3.1 Select thermocouple type: K, J, E, or T

Press the or button to select thermocouple type.
(see Fig.8)



Fig.8

7.3.2 Setting interval time for data storing:

1. Press the or button to set minute or second. (see Fig.9)
2. Press the / button to increase/decrease value.

Note:

Set interval time range: 1
Second (00:01) to 60 minutes 59 seconds
(60:59)



Fig.9

7. OPERATING INSTRUCTIONS

7.3.3 Set offset to compensate for probe errors:

The user can adjust the readings of thermometer to compensate for the errors against a specific thermocouple.

1. Press the or button to select thermocouple channel. (see Fig.10)
Setting thermocouple channel blinks on the LCD screen.
2. Press the / button to increase/decrease value.

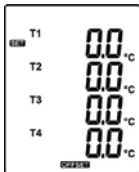

Fig.10

Note:

The offset to compensate for probe errors range: $\pm 5^{\circ}\text{C}$ or $\pm 9^{\circ}\text{F}$.

7.3.4 Set alarm point (only for channel T1):

Want to set window. (see Fig.11 or Fig.12)

1. Press the or button to turn on or off.
2. When setting on mode, press the button to set Hi and Lo limit. (see Fig.13)



Fig.11

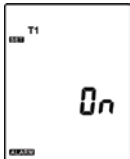

Fig.12

7. OPERATING INSTRUCTIONS

Note:

When measuring thermocouple value over alarm point, the symbol will blink "ALARM Hi" or "ALARM Lo" on the LCD. The beeper will make "beep-beep-beep" sound. The Lo alarm set cannot be greater than Hi alarm set. seconds.



Fig.13

7.3.5 Set T1-T2 subtraction mode:

Press the or button to turn on or off T1-T2 subtraction mode. (see Fig.14 or Fig.15)

Note:

When setting T1-T2 subtraction mode on, T1-T2 will display at the bottom of LCD. (see Fig.16)



Fig.14



Fig.15

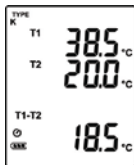

Fig.16

7. OPERATING INSTRUCTIONS

7.3.6 Set auto power off time:

Press the or button to select auto power off option 10, 30 minutes, 1, 2, 4, 8 hours, or off.

(see Fig.17 or Fig.18)



Fig.17



Fig.18

7.3.7 Set system clock:

The unit is built-in a clock so that the data logger function can also record the data and time along with the measurement value.

1. Press the or button to select year, date, or time. (see Fig.19)
2. Press the / button to increase/ decrease value.

Note:

Check the clock setting after replacing batteries. If necessary, reset system clock.







Fig.19

7.4 Clearing Data Logger Records:

1. Turn off the unit.
2. Press and hold button and then press power button to turn on the unit.
3. Keep holding and button, then LCD will show "REC", "CLR" and "SURE 5, 4...1, 0" until clean the memory. (To abort, release all buttons in process)

7.5 Clearing Instant Read-out Memory:

1. Turn off the unit.
2. Keep holding  button and  power button to turn on the unit.
3. Keep holding  button, then LCD will show "**MEM**", "**CLr**" and "**SUR**
5, 4...1, 0" until clean the memory. (To abort, release  button before "**SUR 0**".) The LCD will show "**CLr**", "**0**" and start erasing group 00 to 99 records.

7.6 Connecting to a computer:

The meter can be connected to PC through a micro USB cable or Bluetooth adapter to download recorded data or perform real time monitoring or datalogging in the software interface.

8. POWER PREPARATION

8.1 Battery Replacement:

1. When the battery voltage drops below proper operation range, the  symbol will blink on the LCD display and the battery needs to be replaced.
2. Before replacing the battery, power off the meter, and disconnect all temperature probes. Open the cover of the battery cabinet by a screwdriver. Replace the old batteries with four new UM-4 or AAA size batteries.
3. Close the battery cabinet cover and fasten the screw.

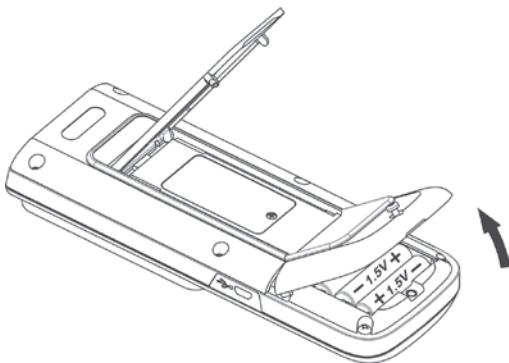

9. MAINTENANCE

In order to ensure the accuracy of the thermometer for a longer period of time you should calibrate it once a year.

Clean the device and the window of the display with a clean, lint-free, antistatic and dry cleaning cloth.



Do not use cleaning agents that contain carbon or benzenes, alcohol or anything similar to clean the product since these substances damage the surface of the measuring instrument. Moreover, these fumes are hazardous to health and explosive.

Do not use tools with sharp edges, screwdrivers, metal brushes or anything similar to clean the device.



10. TESTLINK SE-520 SOFTWARE

10.1 The SE-520 package contains:

- Micro USB cable

10.2 System Required:

Windows XP/ VISTA/ Windows 7/ Windows 8/ Windows 10

10.3 Minimum Hardware Required:

- At least 50 MB hard disk space available to install SE520 software
- Download software here: <https://perfectprime.com/pages/manual> under TC0520
- Recommended screen resolution 1024X768 or above.

10.4 Tutorial - Quick Start to Use SE520:

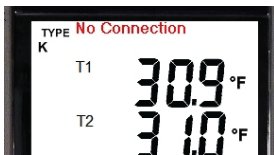

Recording real time data in waveform:

1. Power on the 4 Channel Thermometer first and connect it to a PC USB port with the cable,
2. Start SE520 program.
3. If the connection is successful the panel will display the same value as the 4 Channel Thermometer. If fail to connect the meter with PC, it will display " **No Connection** " on the panel window in SE520.

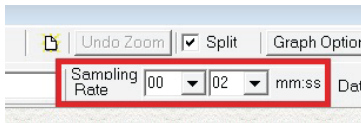

4. Select sampling rate from Real-Time Graph window.



5. When the connection is successful, click "Real Time | run " or  from main menu to start recording real time data and there will be a waveform on the Real Time Graph Window.
6. Click "Real Time | Stop "  or to stop recording.

10.5 How to save the recorded real time data to a file?

1. Click the graph window you want to save and the graph window will become active, then choose File | Save from main menu or click from the tool bar.



An Active Window

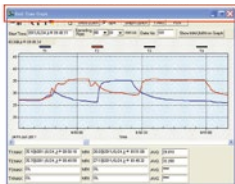

Not Active Window

10. TESTLINK SE-520 SOFTWARE

- There will be a save dialog window for you to choose the file name and file type to save. There are three types of file format you can choose, binary file(*.ghf), text file(*.txt) and EXCEL format file(*.csv). The *.ghf file use much fewer disk space to save the data than the other two file formats, but it can only be used in SE520. Text file can be opened by SE520 and any other word processor program like word, notepad etc. EXCEL format file can be opened by SE520 and Microsoft EXCEL.

Note: If decimal separator is comma in your country, this file format will be disabled, because .CSV file also use comma to be data separator. (For example 78,6 will become 78 and 6 in EXCEL)

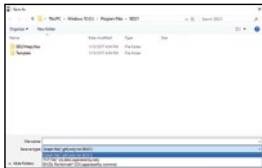

10.6 How to load the recorded data from the memory of 4 Channel Thermometer and save it to a file?





- Power on the 4 Channel Thermometer.
- Press the "REC" button of the meter to start recording data.
- After a while, press "REC" button again to stop recording data.
- Connect the Meter to PC.
- Start SE520 program.
- Choose Data Logger from main menu or click  from tool bar.



- In reference to Data Logger , see DataLogger.

10.7 Main Menu:



	File Open	Retrieve files from the disk.
	Save	Save the active window (when the caption bar is highlighted) data to the disk.
	Print	Print the data of the active window (graph or list).
	Printer Setup	Select printer.
	File Exit	Terminates program.
	View Control Panel	By opening the Panel Window, the user can control meter via the button in this window.
	View Real-Time Graph	Open Real-Time Graph display to graph the present data.
	Real Time Data Run	Start collecting real time data.
	Stop	Stop collecting real time data.

10. TESTLINK SE-520 SOFTWARE



DataLogger:

By opening the DataLogger Window, the user can load recorded data of meter to PC in this window



Output To Graph

Graphing tabular data.

10.8 DataLogger:

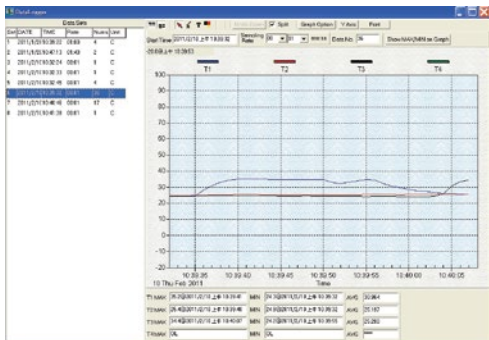



10. TESTLINK SE-520 SOFTWARE

When you have the thermometer connected to PC, select " DataLogger " from main menu or click Datalogger icon from tool bar to load recorded data from the meter and there will be a progress indicator to show the loading status. If error occurs, just click " DataLogger icon " again.

After the data was downloaded, the left hand side will show how many data sets were loaded and detail information for each data set (start data, start time, recording rate and record numbers).

for examples:

Data Sets										
Set	DATE	TIME	Rate	Nums	Unit	Coupl	T1 Offset	T2 Offset	T3 Offset	T4 Offset
1	2016/2/26	16:25:35	00:01	68	F	K	0.0	0.0	0.0	0.0
2	2016/2/26	16:26:49	00:01	26	F	K	0.0	0.0	0.0	0.0
3	2016/2/26	16:27:33	00:01	19	F	K	0.0	0.0	0.0	0.0
4	2016/2/26	16:28:03	00:01	77	F	K	0.0	0.0	0.0	0.0
5	2016/2/26	16:31:34	00:01	11	F	K	0.0	0.0	0.0	0.0
6	2016/2/26	16:31:49	00:01	24	F	K	0.0	0.0	0.0	0.0
7	2016/2/26	16:32:20	00:01	13	F	K	0.0	0.0	0.0	0.0
8	2016/2/26	16:32:39	00:01	13	F	K	0.0	0.0	0.0	0.0
9	2016/2/26	16:32:59	00:01	7	F	K	0.0	0.0	0.0	0.0

It will transfer first data set to graph on the right hand side. The user can also click at any other data set to choose that set for graph.

Graph:

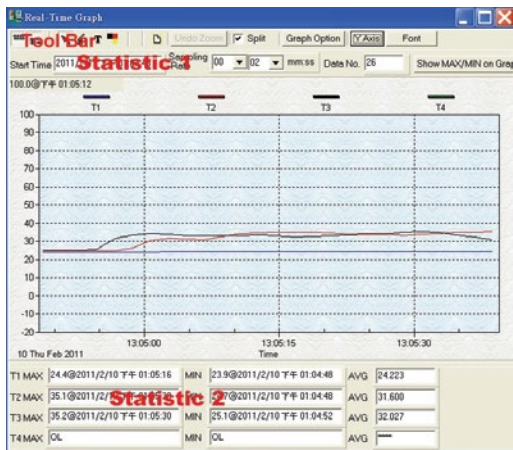

Tool Bar:



Display or hide Statistic1.



Display or hide Statistic2.



Normal cursor.

10. TESTLINK SE-520 SOFTWARE



When selected, the mouse cursor will become a cross sign when moving to the graph, click on the graph to mark a cross sign on the graph. This is available only when " **Split** " option is unchecked. And all the mark you make will exist with T1.



When selected, the mouse cursor will become a " I " sign when moving to the graph, click on the graph to annotate. This is available only when " **Split** " option is unchecked. And all the text you make will exist with T1.



Separate the four channel.

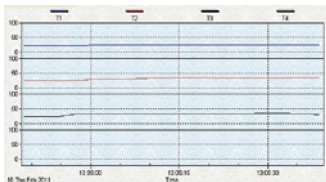

Combine the four channel.

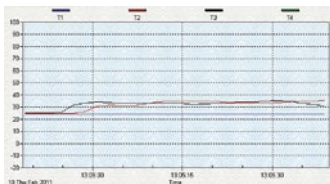

Graph Option

Graph Customization.

Y Axis

Change the Y axis extension

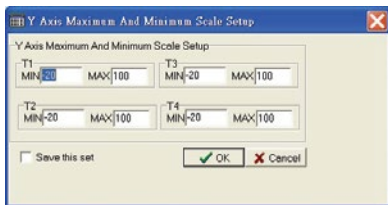

Note: When the Split is unchecked, graph will use T1 as the Y axis display range.

Undo Zoom

To Undo the Zoom

You can Zoom this graph by using mouse:

To Zoom:

1. Press the left mouse button and drag the cursor to select the new extents.
2. Release the mouse button.

You can choose channel number showing in the graph.

- a. Click " **Graph Option** " to call Customization dialog.
- b. Select Subsets tab.
- c. Select a single channel or multiselect (hold Ctrl key, use mouse to choose) channels.



10. TESTLINK SE-520 SOFTWARE

10.9 Frequently Asked Question:

1. How to uninstall SE520?

Answer: Uninstall SE520 by launching the Add/Remove Programs applet out of the Control Panel, highlighting the SE520, and clicking on the Add/Remove... push button, then it will remove the SE520 folder and files from your computer.

2. How to zoom the graph?

Answer: Press the left mouse button and drag the cursor to select the new extents, then release the mouse button.

3. When I setup the real time sampling with a fast rate(eg. 1 sec), Some of the sampling data might be lost.

Answer: This might be caused by slow response time of the PC interface. For better result, the user may close the panel window.

10.10 DOWNLOAD THE PROTOCOL

DOWNLOAD THE PROTOCOL OF SERIAL INTERFACE HERE:

https://cdn.shopify.com/s/files/1/1291/1589/files/TC0520_Protocol_2.pdf?v=1614323464

CUSTOMER SERVICE INQUIRIES

Your emails are important to us so we strive to reply all inquiries and emails within **24 hours**. In exceptional cases, we may require more time to respond.

Thank you for your understanding.

For more information about our products and services, please send us an email:

cs@perfectprime.com

For B2B or project-based application, please send an email:

sales@perfectprime.com

FOR MORE INFORMATION ABOUT PERFECTPRIME PLEASE VISIT OUR ABOUT US PAGE AND FEEL FREE TO BROWSE.



Scan QR Code for the Youtube channel for video manual



Scan QR Code for the Product Manual page (Multi-Language available for certain products)



Scan QR Code to register the product for 1 year warranty



Tyche Smart Limited
cs@perfectprime.com
2nd Floor, 107 Charterhouse Street,
EC1M 6HW, London,
England UNITED KINGDOM

+44 203 7695377

Retailer

Email

Address

Telephone