



Quadro Vino































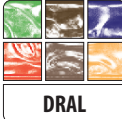

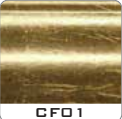





Design Reg. n. TO 2012/41

Design e tecnologia si fondono per dar vita al primo quadro refrigerato mai realizzato al mondo. Un oggetto dal concetto e design innovativo, che permette di conservare con cura anche i vini più importanti. Modelli e finiture diverse per un oggetto sempre unico.

Design and technology come together to create the first refrigerated frame in the world. An appliance innovative both in concept design, which can preserve with care even the finest of wines. Different models and finishes for a one-of-a-kind item.

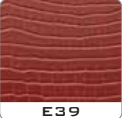
Design et technologie se mélangent pour créer le premier tableau réfrigéré jamais réalisé au monde. Un objet avec un concept et design innovants qui permet la conservation soignée des vins plus prestigieux. Modèles et finitions différentes pour un objet toujours unique.

COLORS

 L10 bianco opaco matte white blanc mat	 L11 nero opaco matte black noir mat	 L20 castagno chestnut chêne	 L21 teak roble teak roble teck rouvre	 L22 wengé loft loft wenge wenge loft	 L23 larice cenere ash larch mélèze cendre
 L40 cemento tortora dove concrete ciment taupe	 L50 acciaio satinato brushed steel acier brossé	 RAL 9010 bianco opaco matte white blanc mat	 RAL 9005 nero opaco matte black noir mat	 V01 verniciato oro gold paint peinture or	 V02 verniciato argento silver paint peinture argent
 M01 MDF non verniciato no finish MDF MDF non peint	 RAL opaco - lucido matte - glossy mat - brillant	 DRAL 9010 bianco opaco matte white blanc mat	 DRAL 9005 nero opaco matte black noir mat	 DF01 oro patinato gold coated revêtement or	 DF02 argento patinato silver coated revêtement argent
 DV01 verniciato oro gold paint peinture or	 DV02 verniciato argento silver paint peinture argent	 D01 Dune non verniciato no finish Dune Dune non peint	 DRAL opaco - lucido matte - glossy mat - brillant	 CRAL 9010 bianco opaco matte white blanc mat	 CRAL 9005 nero opaco matte black noir mat
 CF01 oro patinato gold coated revêtement or	 CF02 argento patinato silver coated revêtement argent	 CVD1 verniciato oro gold paint peinture or	 CVD2 verniciato argento silver paint peinture argent	 C01 non verniciato no finish non peint	 CRAL opaco - lucido matte - glossy mat - brillant
 E10 ecopelle bianca white faux leather éco-cuir blanc	 E11 ecopelle nera black faux leather éco-cuir noir	 E12 ecopelle grigia grey faux leather éco-cuir gris	 E13 ecopelle rossa red faux leather éco-cuir rouge	 E30 sughero rete cork mesh liège filet	 E31 sughero spina di pesce cork herringbone liège chevrons
 E39 ecopelle pitone rosso red python faux leather éco-cuir python rouge	 E40 ecopelle rettile nera black faux reptile leather éco-cuir reptile noir	 E41 ecopelle rettile blu blue faux reptile leather éco-cuir reptile bleu	 E50 ecopelle intrecciata tabacco tobacco woven faux leather éco-cuir tissé tabac		

I modelli

Models • Modèles



QV12



QV30



QV40



QV52



Quadro Vino n. 12

Cornice bianca ed interni in colore nero.
Modello versatile ed innovativo per
ambientazioni al limite dell'immaginabile.

White frame and black interiors.
A versatile and innovative model for extraor-
dinary settings.

Encadrement blanc et intérieur en noir.
Modèle polyvalent et innovant pour colloca-
tions à la limite de l'imaginable.

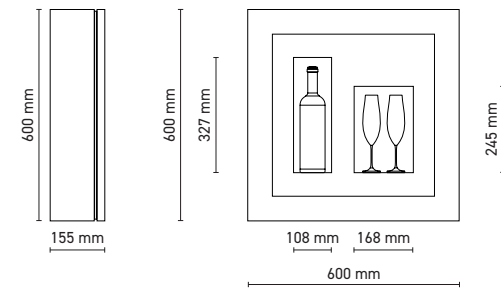

 °C
 + 4 / +10

Quadro Vino n. 12

Espositore refrigerato per una bottiglia e vano neutro per 2 calici.

Il Quadro Vino n. 12 può essere inserito in qualsiasi ambiente.

Un'atmosfera unica e nuova che invita ad un brindisi veramente speciale.

Refrigerated display for one bottle and compartment for 2 stem glasses.

Quadro Vino n.12 fits any environment.

A new and unique atmosphere that calls for a very special toast.

Présentoir réfrigéré pour une bouteille et un compartiment neutre pour 2 flutes.

Le Quadro Vino n. 12 peut être adapté dans n'importe quel environnement.

Une atmosphère unique et nouvelle qui invite à porter un toast vraiment spécial.



Quadro Vino n. 30

Struttura e pannello interno in colore nero con Cornice porta in HPL Larice cenere. Apprezzabile inserimento in zona giorno per l'esposizione di bottiglie importanti.

Black structure and internal panel, with door frame in Ash Larch-finish HPL. Suits your living room when displaying important bottles.

Structure et panneau intérieur noir avec encadrement en HPL mélèze cendre. Addition agréable dans un salon pour l'exposition de bouteilles importantes.

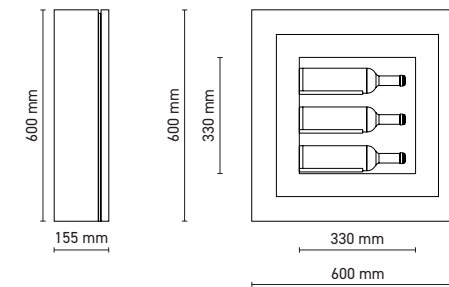

 °C
 + 8 / +20

Quadro Vino n. 30

Il modello QV30 consente di mantenere a temperatura di servizio fino a 3 bottiglie.

Nell'immagine a lato è rappresentato il modello con struttura e pannello interno in colore nero e Cornice porta laccata RAL bronzo.

The QV30 model can store up to 3 bottles at service temperature.

The image shows a model with black structure and internal panel with door frame in bronze paint finish.

Le modèle QV30 vous permet de garder à température de service jusqu'à 3 bouteilles.

Dans l'image à côté on voit le modèle avec structure et panneau intérieur en coloris noir et cadre en RAL bronze.



Quadro Vino n. 40

I modelli con la cornice in colore RAL evidenziano l'importanza della personalizzazione.
Eleganza e vivacità in zona giorno.

Models with frame in RAL finish show the power of customisation.
For an elegant and vibrant living room.

Modèles avec le cadre en différentes couleurs RAL souligne l'importance de la personnalisation.
Élégance et vivacité dans le coin salon.



QV40

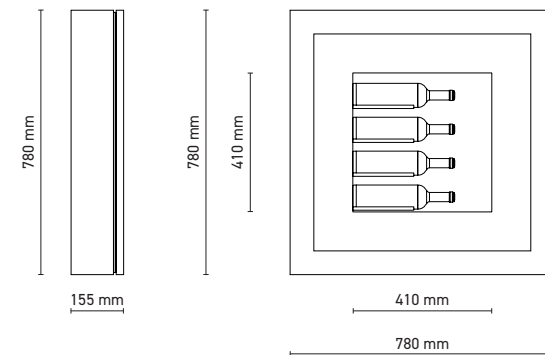

 °C
 + 12 / +20

Quadro Vino n. 40

Il modello QV40 rappresenta la geometria perfetta.
 L'installazione sopra il divano testimonia senza alcun dubbio l'originalità funzionale di questo oggetto.

The QV40 model embodies perfect geometry.
 The installation above the sofa highlights the functional uniqueness of this item.

Le modèle QV40 représente l'équilibre géométrique parfait.
 Son installation au-dessus d'un canapé témoigne sans doute l'originalité fonctionnelle de cet objet.



Quadro Vino n. 52

Geometrie leggermente diverse per il QV52.
I vani rettangolari di bottiglie e bicchieri
contrastano in modo armonico con la forma
quadrata della cornice.

A different kind of geometry for QV52.
The rectangular compartments for bottles and
glasses gracefully contrast with the square
shape of the frame.

Espaces géométriques légèrement différents
pour le QV52.
Les compartiments rectangulaires de bouteilles
et de verres contrastent harmonieusement avec
la forme carrée du cadre.



Quadro Vino n. 52

La cornice Dune in foglia argento dona al Quadro Vino un design ricercato quanto inusuale.
L'originalità nasce dalla scelta dei dettagli.



QV52

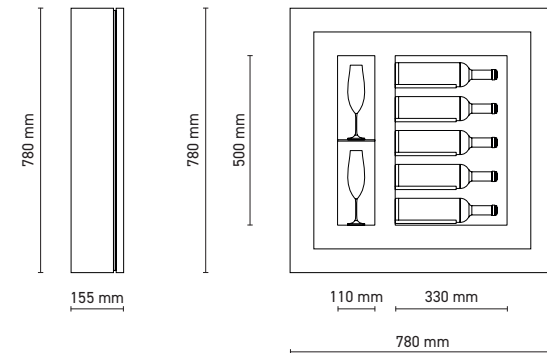

 °C
+ 12 / +20

The "Dune" frame in silver leaf finish gives Quadro Vino a neat and original look.
Uniqueness comes from choice in details.

Le cadre Dune en feuille d'argent donne au Quadro Vino un design recherché inhabituel.
L'originalité vient du choix de détails.

Quadro Vino

Il Quadro Vino permette di conservare e servire vini diversi alla giusta temperatura. La refrigerazione è ottenuta con un silenzioso impianto termoelettrico dal consumo molto limitato. La minima profondità consente l'installazione anche in spazi molto ridotti.

Il Quadro Vino ha un impianto di refrigerazione ecologico privo di gas inquinanti ed è costruito con materiali riciclabili. La sostituzione dei componenti è semplice e rende sempre conveniente la riparazione del prodotto.

Quadro Vino allows you to preserve and serve different wines at the right temperature. Refrigeration is achieved thanks to a silent thermoelectrical system with very low consumption. Its minimal depth allows for installation even in small spaces.

Quadro Vino employs a polluting-gas free, green refrigeration system and is made with recyclable materials. Replacement of spare parts is simple, making product maintenance always affordable.

Quadro Vino permet de stocker et servir différents vins à la correcte température. La réfrigération est obtenue par un système thermoélectrique silencieux à la consommation d'énergie très faible. La profondeur réduite permet une installation dans des petits espaces.

Quadro Vino dispose d'un système de réfrigération écologique sans la présence de gaz polluant et il est fabriqué avec des matériaux recyclables. Le remplacement des composants est simple et rend toujours économique la réparation du produit.

CARATTERISTICHE TECNICHE

Specifications · Caracteristiques techniques

Struttura in metallo
Struttura porta in alluminio
Cornice in legno / hpl / MDF
Vetrocamera 20 mm
Guarnizione magnetica
Pannello interno in acciaio
Illuminazione a LED bianco naturale
4000 K - 30 led/mt - 7,2 W / mt - 572 lumen / mt
Impianto termoelettrico
Sbrinamento automatico
Refrigerazione ventilata
Sistema di antivibrazione

Metal structure
Aluminum door structure
Wood / HPL / MDF door frame
20 mm double glazing
Magnetic gasket
Internal steel panel
White natural daylight LED
4000 K - 30 led/mt - 7,2 W / mt - 572 lumen / mt
Thermoelectric system
Automatic defrosting
Ventilated refrigeration
Anti-vibration system

Structure métallique
Structure porte en aluminium
Cadre en bois / HPL / MDF
Double vitrage 20 mm
Joint magnétique
Panneau interne en acier
LED blanc day-light naturel
4000 K - 30 led/mt - 7,2 W / mt - 572 lumen / mt
Système thermoélectrique
Dégivrage automatique
Réfrigération ventilée
Système anti-vibration

CONFIGURATORE ONLINE

Online builder · Outil de configuration en ligne



<https://quadro-vino.expohome.it>

Accedendo all'area "configuratori" del sito sarà possibile configurare oltre 1.000 modelli di Quadro Vino.

By accessing the «Configurator» on the website it will be possible to configure more than 1,000 different models of Quadro Vino.

En accédant au «Configurateur» sur le site, il sera possible de configurer plus de 1000 modèles différents de Quadro Vino.



MODELLO · MODEL · MODÈLE



QV12



QV30



QV40



QV52

1 - STRUTTURA · STRUCTURE · STRUCTURE

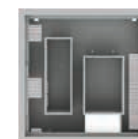

RAL 9010
bianco
white
blanche
B



RAL 9005
nero
black
noir
N

2 - CORNICI · FRAMES · CADRES



3 - PANNELLI · PANELS · PANNEAUX



COLORE LUCE · LIGHT COLOUR · COLOIS LUMIÈRE

Standard



LED bianco naturale
white natural daylight LED
LED blanc day-light naturel

Optional



LED blu
blue LED
LED bleu

OPT-QLB

Quadro Vino

CODE					N. 0,75 LT	H Ø		Class													°C TA 22°C	°C TA 25°C	°C TA 28°C		
	QV12N		QV12B	600 x 600 x 155	700 x 700 x 250	800 x 1000 x 390	1	H 324 Ø 105	3		N	G	30	238	○○○	29	100 - 240V	22	25	33	0,1	0,3	+4 / +6	+6 / +8	+8 / +10
	QV30N		QV30B	600 x 600 x 155	700 x 700 x 250	800 x 1000 x 390	3	H 328 Ø 98	11		N	G	60	194	○○○	29	100 - 240V	22	25	33	0,1	0,3	+8 / +10	+10 / +12	+12 / +14
	QV40N		QV40B	780 x 780 x 155	860 x 860 x 250	1000 x 1000 x 390	4	H 400 Ø 90	16		N	G	60	182	○○○	29	100 - 240V	30	39	45	0,2	0,4	+12 / +14	+14 / +16	+16 / +18
	QV52N		QV52B	780 x 780 x 155	860 x 860 x 250	1000 x 1000 x 390	5	H 328 Ø 90	15		N	G	60	198	○○○	29	100 - 240V	30	39	45	0,2	0,4	+12 / +14	+14 / +16	+16 / +18

CORNICE • FRAMES • CADRES

CODE																																
			●																													600 x 600 x 7
			●																													780 x 780 x 7

PANNELLO • PANELS • PANNEAUX

CODE															
		●											540 x 540 x 1,2	-	-
		●											540 x 540 x 1,2	-	-
		●											715 x 715 x 1,2	-	-
		●											715 x 715 x 1,2	-	-

OPTIONAL - LED BLU

CODE	DS
●●● QV-OPT-LB	Optional LED blu - <i>Optional blue LED - Optional LED bleu</i>
QV-OPT-BV	Allestimento bottiglie verticali - <i>Vertical bottles accomodation - Logement bouteilles en vertical</i>

* I colori RAL vengono realizzati su supporto di MDF in finitura opaca 20 gloss (finitura lucida 100 gloss su richiesta).

* RAL colours are made on MDF 20-gloss matte finish (100-gloss finish available on request)

* Les couleurs RAL sont réalisés sur support en MDF en finition matte 20 Gloss (ou bien sur demande brillante 100 Gloss).

HPL laminato alta pressione • high pressure laminate • stratifiés haute pression



MDF non verniciato • No finish MDF • MDF non peint



MDF non verniciato
no finish MDF
MDF non peint

Verniciatura a liquido • Liquid paint finish • Laquage par peinture liquide



Verniciatura a liquido (Dune) • Liquid paint finish (Dune) • Laquage par peinture liquide (Dune)



Dune non verniciato • No finish Dune • Dune non peint



Dune non verniciato
no finish Dune
Dune non peint

Rivestimento in foglia (Dune) • Leaf finish (Dune) • Revêtement en feuille métallique (Dune)

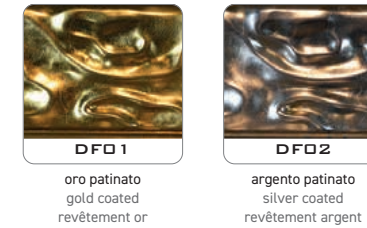

Verniciatura a liquido (Classica) • Liquid paint finish (Classic) • Laquage par peinture liquide (Classique)



CRAL 9010
bianco opaco (20 gloss)
matte white (20 gloss)
blanc mat (20 gloss)



CRAL 9005
nero opaco (20 gloss)
matte black (20 gloss)
noir mat (20 gloss)



CVO1
verniciato oro
gold paint
peinture or



CVO2
verniciato argento
silver paint
peinture argent



CRAL 20/100
opaco 20 gloss - lucido 100 gloss
matte 20 gloss - glossy 100 gloss
mat 20 gloss - brillant 100 gloss

Classica non verniciata • No finish Classic • Classique non peint



CO1
Classica non verniciata
no finish Classic
Classique non peint

Rivestimento in foglia (Classica) • Leaf finish (Classic) • Revêtement en feuille métallique (Classique)



CFO1
oro patinato
gold coated
revêtement or



CFO2
argento patinato
silver coated
revêtement argent

Ecopelle • Faux leather • Éco-cuir



E10
ecopelle bianca
white faux leather
éco-cuir blanc

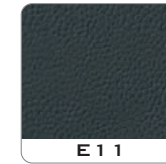

E11
ecopelle nera
black faux leather
éco-cuir noir



E12
ecopelle grigia
grey faux leather
éco-cuir gris



E13
ecopelle rossa
red faux leather
éco-cuir rouge

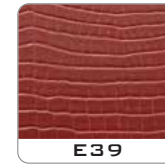

E39
ecopelle pitone rosso
red python faux leather
éco-cuir python rouge

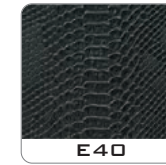

E40
ecopelle rettile nera
black faux reptile leather
éco-cuir reptile noir



E41
ecopelle rettile blu
blue faux reptile leather
éco-cuir reptile bleu



E50
ecopelle intrecciata tabacco
tobacco woven faux leather
éco-cuir tissé tabac

Sughero • Cork • Liège



E30
sughero rete
cork mesh
liège filet



































E31
sughero spina di pesce
cork herringbone
liège chevrons



 RAL 1001 BEIGE	 RAL 1002 SAND YELLOW	 RAL 1003 SIGNAL YELLOW	 RAL 1006 MAIZE YELLOW	 RAL 1007 DAFFODIL YELLOW	 RAL 5020 OCEAN BLUE	 RAL 6005 MOSS GREEN	 RAL 6011 RESEDA GREEN	 RAL 6019 PASTEL GREEN	 RAL 7000 SQUIRREL GREY
 RAL 1011 BROWN BEIGE	 RAL 1014 IVORY	 RAL 1015 LIGHT IVORY	 RAL 1019 GREY BEIGE	 RAL 1024 OCHRE YELLOW	 RAL 7001 SILVER GREY	 RAL 7003 MOSS GREY	 RAL 7004 SIGNAL GREY	 RAL 7006 BEIGE GREY	 RAL 7011 IRON GREY
 RAL 1034 PASTEL YELLOW	 RAL 2000 YELLOW ORANGE	 RAL 2003 PASTEL ORANGE	 RAL 2010 SIGNAL ORANGE	 RAL 3004 PURPLE RED	 RAL 7030 STONE GREY	 RAL 7032 PEBBLE GREY	 RAL 7035 LIGHT GREY	 RAL 7036 PLATINUM GREY	 RAL 7042 TRAFFIC GREY A
 RAL 3005 WINE RED	 RAL 3007 BLACH RED	 RAL 3009 OXIDE RED	 RAL 3012 BEIGE RED	 RAL 3017 ROSE	 RAL 8002 SIGNAL BROWN	 RAL 8007 FAWN BROWN	 RAL 8014 SEPIA BROWN	 RAL 8017 CHOCOLATE BROWN	 RAL 8019 GREY BROWN
 RAL 3031 ORIENT RED	 RAL 4001 RED LILAC	 RAL 4004 CLARET VIOLET	 RAL 4009 PASTEL VIOLET	 RAL 5003 SAPPHIRE BLUE	 RAL 8022 BLACK BROWN	 RAL 8025 PALE BROWN	 RAL 8028 TERRA BROWN	 RAL 9001 CREAM	 RAL 9002 GREY WHITE
 RAL 5004 BLACK BLUE	 RAL 5005 SIGNAL BLUE	 RAL 5008 GREY BLUE	 RAL 5012 LIGHT BLUE	 RAL 5014 PIGEON BLUE	 RAL 9003 SIGNAL WHITE	 RAL 9004 SIGNAL BLACK	 RAL 9005 JET BLACK	 RAL 9010 PURE WHITE	 RAL 9016 TRAFFIC WHITE

Legenda • Legend • Légende

CODE	Codice	Code	Code
	Temperatura (UR 50%)	Temperature (UR 50%)	Température (UR 50%)
	Tensione	Voltage	Tension
	Assorbimento	Absorption	Absorption
	Consumo kWh annui	kWh consumption per year	Consommation kWh annuelle
	Classe energetica	Energy efficiency rating	Classe énergie
Class	Classe climatica	Climate class	Classe climatique
	Pressione acustica Leq (h 155 cm - d. 100 cm)	Leq sound pressure level (h 155 cm - d 100 cm)	Leq niveau pression acoustique (h 155 cm - d 100 cm)
	Capacità	Capacity	Capacité
	Gas refrigerante	Refrigerant gas	Gaz réfrigérant
	Luce	Light	Lumière
	Led bianco caldo (3000 K - 30 led/mt - 1,12 W / mt - 130 lumen / mt)	brightwhite warm LED (3000 K - 30 led/mt - 1,12 W / mt - 130 lumen / mt)	LED blanc chaud (3000 K - 30 led/mt - 1,12 W / mt - 130 lumen / mt)
	Led bianco naturale (4000 K - 30 led/mt - 7,2 W / mt - 572 lumen / mt)	White natural daylight LED (4000 K - 30 led/mt - 7,2 W / mt - 572 lumen / mt)	LED blanc day-light naturel (4000 K - 30 led/mt - 7,2 W / mt - 572 lumen / mt)
	Led blu	Blue LED	LED bleue
	Controller RGB (30 led/mt - 7,2 W / mt - 550 lumen / mt)	RGB controller (30 led/mt - 7,2 W / mt - 550 lumen / mt)	Regulateur RGB (30 led/mt - 7,2 W / mt - 550 lumen / mt)
	Controller bianco dinamico (2700/6000 K - 140 led/mt - 19,2 W / mt - 2000 lumen / mt)	Dinamic white controller (2700/6000 K - 140 led/mt - 19,2 W / mt - 2000 lumen / mt)	Regulateur blanc dynamique (2700/6000 K - 140 led/mt - 19,2 W / mt - 2000 lumen / mt)
	Lato posteriore vetrina	Showcase back side	Face postérieure vitrine
	Ante in vetro	Glass doors	Porte en verre
	Pannello cieco	Blank panel	Panneau borgne
	Numero piani (base compresa)	Number of shelves (including base)	Nombre de tablettes (base comprise)
	Bottiglie	Bottles	Bouteilles
	Numero bottiglie da 0,75 Lt	Number of bottles 0,75 lt.	Quantité bouteilles 0,75 lt.
	Altezza e diametro massimo bottiglie	Maximum height and diameter of the bottles	Hauteur et diamètre maximum des bouteilles
	Presente	Present	Présent
-	Assente / dato non disponibile	Absent / data not available	Absent / information non disponible
	Dimensioni nette	Net dimensions	Dimensions nettes
	Dimensioni con imballo	Dimensions including packaging	Dimensions avec emballage
	Dimensioni con imballo su pedana	Dimensions including packing on pallet	Dimensions avec emballage sur palette
	Peso netto	Net weight	Poids net
	Peso con imballo	Weight with packaging	Poids avec emballage
	Peso con imballo su pedana	Weight with packing on pallet	Poids avec emballage sur palette
	Volume con imballo	Volume with packaging	Volume avec emballage
	Volume con imballo su pedana	Volume with packaging on pallet	Volume avec emballage sur palette
	Imballo in legno	Wooden packaging	Emballage en bois
	Numero colli	Number of packagings	Quantité colis