

DUNAVOX Glance-32

DAVG-32.80DB.TO EAN: 5999558434403

DAVG-32.80DSS.TO EAN: 5999558434410

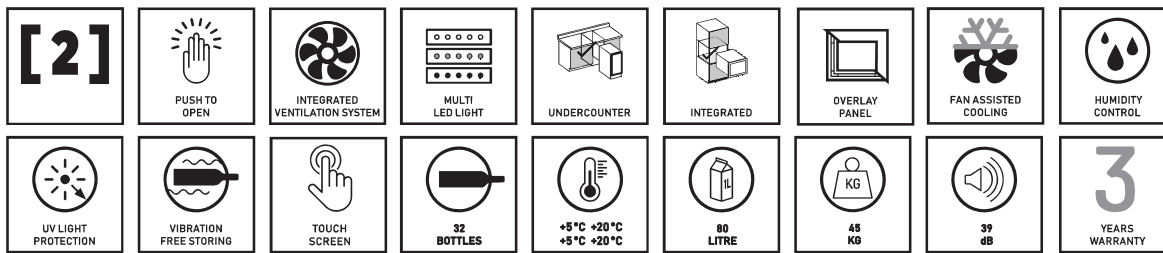

Door frame	Full glass black door / Stainless steel frame
Door reversible	Yes
Glass	Triple glazed
Bottle capacity	32 bordeaux bottles
Bottle types	Bordeaux, Rhone
Temperature zones	2
Door opening	Push to open
Lock	No
Door opening sensor	Yes
Height	715 mm
Width	592 mm
Depth	559 mm
Internal height	550 mm
Internal width	470mm
Internal depth	Upper:400 mm/350 mm Lower:320 mm/300 mm
Packing height	810 mm
Packing width	660 mm
Packing depth	660 mm
Installation	Integrated and undercounter
Ventilation design	Integrated ventilation
Display type	LED
Display colour	White
Interior light	LED lighting
Interior light colour	White, amber and blue
Shelves	3x Wooden shelves
Shelf height	75 mm/80 mm/95 mm/160 mm
Internal air circulation	Yes, fan assisted
Upper temperature range	5-20 °C**
Middle temperature range	-
Lower temperature range	5-20 °C
Temperature memory function	Yes, in case of power failure
Defrosting	Manual
Carbon filter	Yes
Grille	No
Total volume	80 L
Cabinet material	Metal
Cabinet colour	Black
Optimal usage	Domestic
Vibration free-storing	Yes
Internal humidity	50-80%
Warranty	3 years
Compressor warranty	5 years

Energy class	G
Annual energy consumption	133 kW/annum
Daily energy consumption	0,383 kW/daily
Power	220-240V AC 50Hz
Rated current	1.2 A
Cable length	2 m
Noise level	39 dB
Climate class	ST
Cooling method	Compressor
Refrigerant type	R600a
Refrigerant amount	22 g
Handle	-
Net weight	45 Kg
Gross weight	48 Kg

DAVG-32.80DB.TO



DAVG-32.80DSS.TO



** The top zone must be cooler than the lower zone, recommended temperature difference is 4°C.

Bottle loading

Energy label

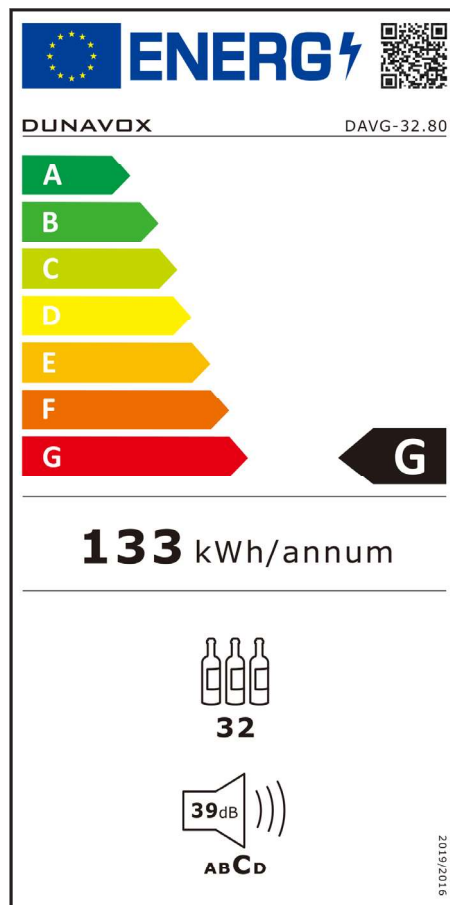
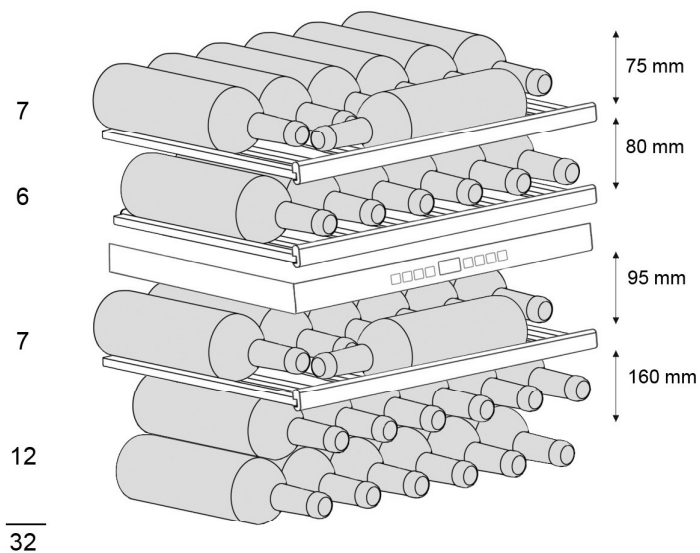

Installation drawing

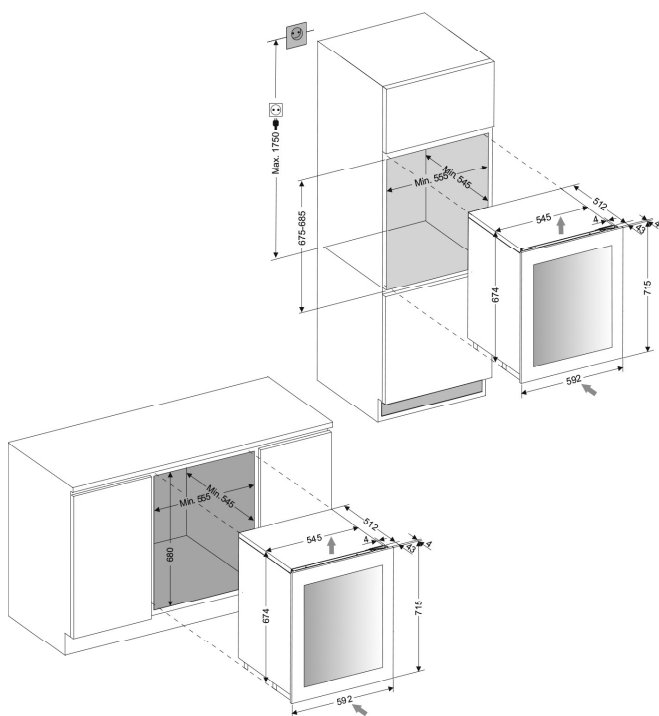

Front View

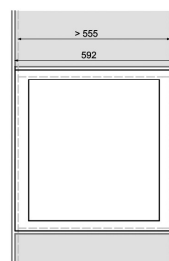

Side View

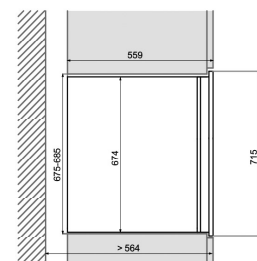

Top View

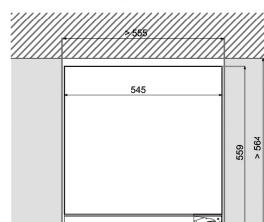

Remove

