

OXYGEN

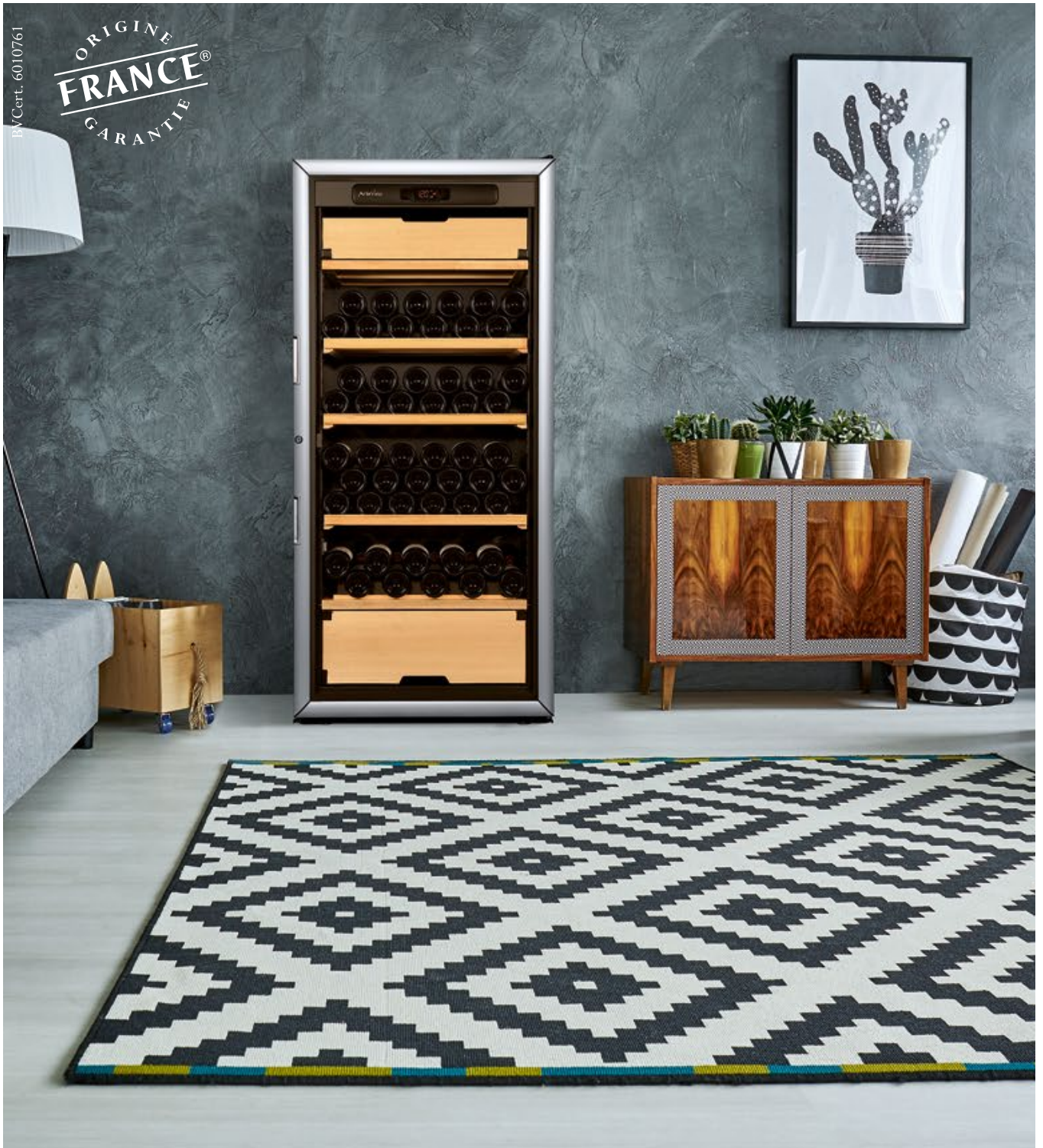

BV Cert. 6010761

ORIGINE
FRANCE[®]
GARANTIE



MADE IN FRANCE

PROTECT YOUR WINE, OPTIMISE YOUR STORAGE CAPACITY
Cabinets specially designed for your best wines with a wide choice of functionalities,
sizes and finishing.

ArteVino

ArteVino

A brand belonging to the EuroCave Group, the world leader in the wine serving and storage market, ArteVino draws on the Group's expertise to design wine cabinets of the highest possible standard.

ArteVino wine cabinets recreate the best possible environment to ensure your best bottles mature in optimal conditions. With a modern, elegant design and a universal shelf designed to adapt to your needs, ArteVino wine cabinets fit perfectly into your interior and guarantee enjoyable experiences shared round a glass of wine.



OXYGEN

ArteVino Expertise	p.4
Modularity & ergonomics	p.5
Versatility	p.6
Personalization	p.7

EXPERTISE

PROTECTING YOUR WINE

ArteVino relies on the expertise of the EuroCave Group to design its wine cabinets with the highest level of requirements. Benefit from the perfect environment for correctly ageing your wine:

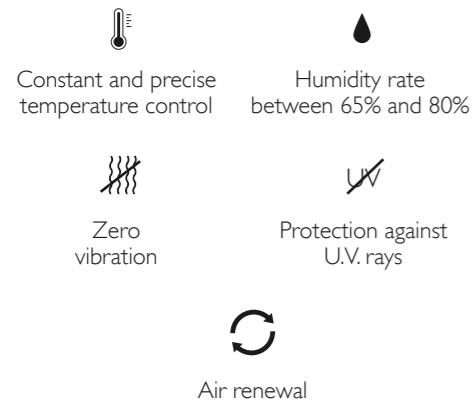

HIGH QUALITY MATERIALS

To ensure the best performance, ArteVino uses sustainable and high quality materials for the body and equipment of its wine cabinets. Inner walls in aluminium, reinforced insulation and wooden shelves.

Made in France

Manufactured in Fourmies (North of France), in the Eurocave Group factory, the world expert in wine storage and serving solutions.



MODULARITY & ERGONOMICS

ONE SHELF, SEVERAL USES

As a real specialist, ArteVino has fitted all its range with universal shelves. These beech wood shelves can hold all bottle sizes and change from storage to sliding or display mode. Optimal storage flexibility and quality!

THE ARTEVINO UNIVERSAL SHELF

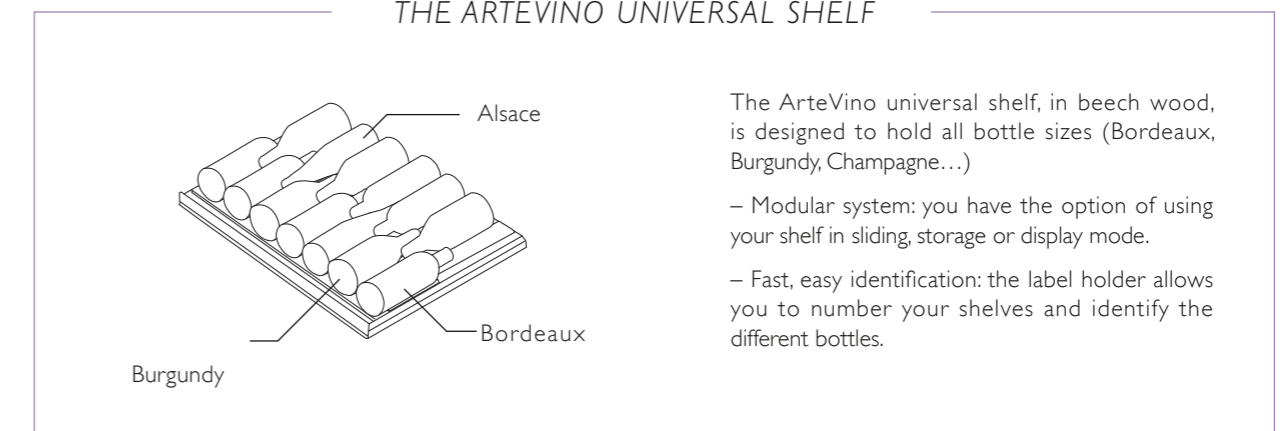

STORAGE SHELF

Designed for a maturing cabinet to store a large number of bottles, for which regular access is not necessary.

It optimises the cabinet's capacity.

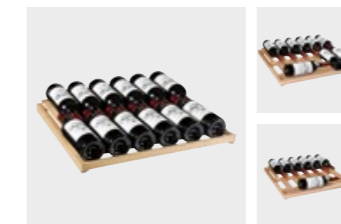

SLIDING SHELF

Designed for a serving cabinet or to offer quick and easy access to some bottles.

This format ensures optimal protection of labels by preventing scraping, and easy access to all bottles.



DISPLAY SHELF

Designed for a serving cabinet or maturing cabinet fitted with a glass door.

This format allows you to display the labels of your most prestigious bottles.



VERSATILITY

MEETS ALL YOUR REQUIREMENTS

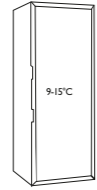

MATURING CABINET

Use : For storing and maturing wine for a period of 2 to over 20 years. Wine maturing cabinets recreate the ideal conditions found in a natural cellar to meet the 6 criteria required for optimal wine maturing.

Features : A single, adjustable temperature, uniform throughout the cabinet (ideal temperature for maturing all wine: 12°C).

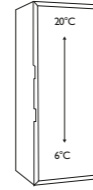

WINE SERVING CABINET

Use : Whilst wine is stored at 12°C, it is not necessarily drunk at this temperature. The serving or multi-temperature cabinet allows you to store your wine for a period of up to 2 years, at an ideal serving temperature. Can be used for all types of wine.

Features : A temperature gradient throughout the cabinet from 6°C for cooling to 20°C for bringing your red wines to room temperature.

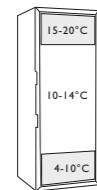

MULTI-FUNCTION CABINET

Use : One wine cabinet for many uses. For storing and bringing wine to the correct serving temperature.

Features : 3 separate compartments:

- A central compartment for storing wine.
- A lower compartment for cooling wine.
- An upper compartment for bringing your red wine to room temperature before serving.

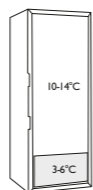

MULTI-DRINKS CABINET*

Use : Maturing your wine and bringing all types of cold drinks to the correct serving temperature (champagne, fizzy drinks, beer, fruit juice) is now possible with the multi-drinks wine cabinet.

Features : 2 separate compartments:

- An upper compartment for storing and maturing wine.
- A lower compartment for preparing all types of cold drinks for serving.

*This wine cabinet is not available for the EU countries

VERSATILITY

MEETS ALL YOUR REQUIREMENTS

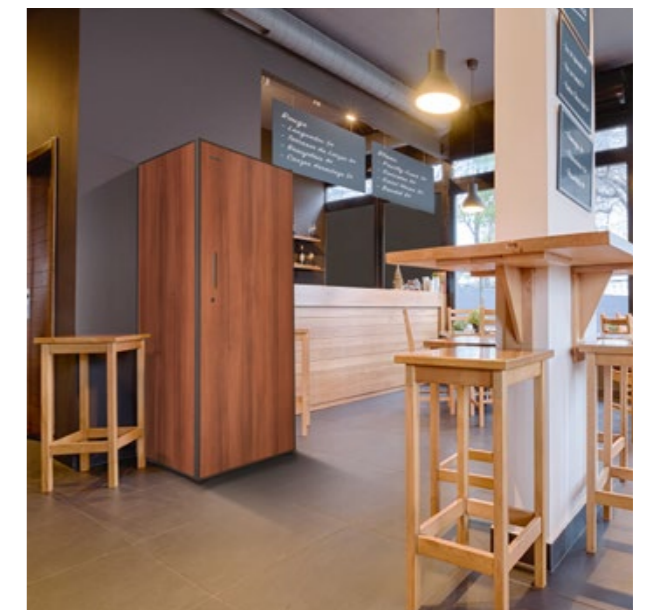

4 DOORS*

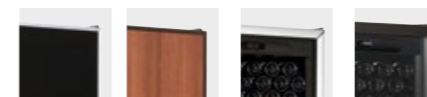

Solid black door with silver frame
 Solid tobacco plane tree door with black frame
 Glass door with silver frame
 Glass door with black frame

2 COLOURS*



Tobacco plane tree*
 Black surf
 NS
 PL

REVERSIBLE DOOR

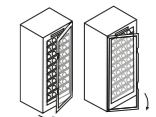

Except for solid doors

*available depending models

TECHNICAL DATA

FEATURES – MATURING CABINET

Standard equipment bottle layout

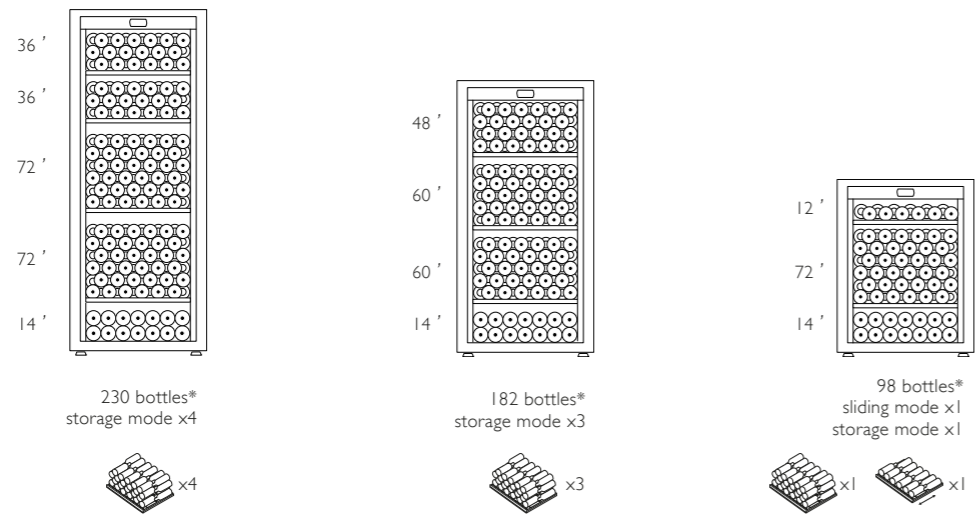

Function

Single-temperature

Dimensions

Large size (HxWxD) = 1825 x 680 x 725 mm
 Medium size (HxWxD) = 1480 x 680 x 725 mm
 Small size (HxWxD) = 960 x 680 x 725 mm

Cabinet temperature setting range

9°C - 15°C
 (one temperature throughout the cabinet)

Recommended room temperature range

0°C - 35°C – solid door
 0° C - 30°C – glass door

Type of shelf

Universal, in beech wood

Sound emission

37 dB(A)

Sound Emission class

C

Feet

2 adjustable feet

Type of door

Solid door
 U.V.-proofed double-glazed glass door

Lock

Yes

Visual alarm

Yes, temperature alarm

Colour

Black or tobacco plane tree

Door finishing

Solid black door with silver frame
 Solid tobacco plane tree door with black frame
 Glass door with silver frame
 Glass door with black frame

TECHNICAL DATA

FEATURES – SERVING CABINET

Standard equipment bottle layout

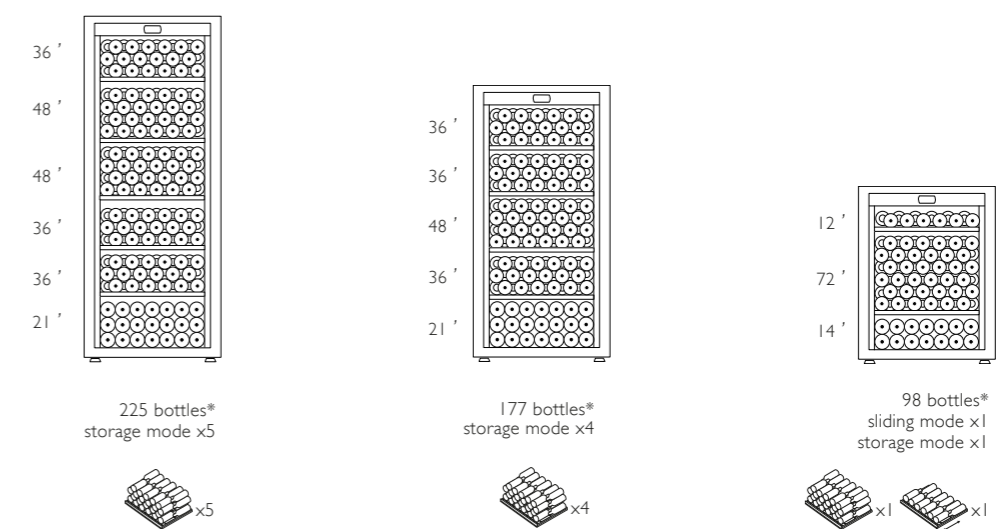

Function

Multi-temperature

Dimensions

Large size (HxWxD) = 1825 x 680 x 725 mm
 Medium size (HxWxD) = 1480 x 680 x 725 mm
 small size (HxWxD) = 960x680x725 mm

Cabinet temperature gradient

6°C - 20°C

Temperature setting range at bottom of cabinet

6°C - 10°C

Temperature setting range at top of cabinet

15°C - 20°C

Recommended room temperature range

12°C - 30°C

Type of shelf

Universal, in beech wood

Sound emission

37 dB(A)

Sound Emission class

C

Feet

2 adjustable feet

Type of door

Solid door
 U.V.-proofed double-glazed glass door

Lock

Yes

Visual alarm

Yes, temperature alarm

Colour

Black

Door finishing

Solid black door with silver frame
 Glass door with silver frame

* Traditional Bordeaux bottles – hollow base.

Further details on the EPREL database. You can obtain the EPREL data sheet by contacting your ArteVino reseller.

* Traditional Bordeaux bottles – hollow base.

Further details on the EPREL database. You can obtain the EPREL data sheet by contacting your ArteVino reseller.

TECHNICAL DATA

FEATURES – MULTI-FUNCTION CABINET

Standard equipment bottle configuration

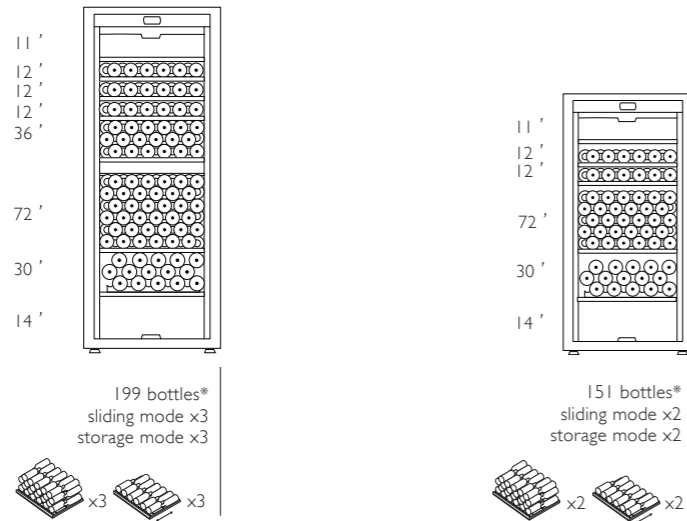

Function

3-temperature

Compartments

3 separate compartments:
A lower compartment for cooling,
a central compartment for maturing and an upper
compartment for bringing red wine to room temperature.

Dimensions

Large size (HxWxD) = 1825 x 680 x 725 mm
Medium size (HxWxD) = 1480 x 680 x 725 mm

Temperature setting range for the red service temperature compartment

15°C - 20°C

Temperature setting range for the central compartment

10°C - 14°C

Temperature setting range for the lower compartment

4°C - 10°C

Recommended room temperature range

12°C - 30°C

Type of shelf

Universal shelf in beech wood
and 2 wooden compartments

Sound emission

37 dB(A)

Sound Emission class

C

Feet

2 adjustable feet

Type of door

Solid door
U.V.-proofed double-glazed
glass door

Lock

Yes

Visual alarm

Yes, temperature alarm

Colour

Black

Door finishing

Solid black door with silver frame
Glass door with silver frame
Glass door with black frame

TECHNICAL DATA

FEATURES – MULTI-DRINKS CABINET*



Maturing compartment with maximum capacity
for 144 bottles.* *

Partition which allows separation of the
two compartments and bottle storage.

Chilling compartment can be set from 3 - 6°C
for all types of bottles.

① Removable rack designed for bottled beer,
cans and other fizzy drinks...

Function

2-temperature

Compartments

2 separate compartments:
A lower compartment for chilling and an upper
compartment for maturing

Dimensions

Large size (HxWxD) = 1825 x 680 x 725 mm

Temperature setting range for the chilling compartment

3°C - 6°C

Temperature setting range for the main compartment

10°C - 14°C

Recommended room temperature range

12°C - 25°C

Type of shelf

Universal in beech wood
Multi-drinks shelf

Sound emission

37 dB(A)

Sound Emission Class

C

Feet

2 adjustable feet

Type of door

Solid door
U.V.-proofed double-glazed
glass door

Door finishing

Solid black door with silver frame
Glass door with silver frame

Lock

Yes

Visual alarms

Yes, temperature alarm

Colour

Black

* Traditional Bordeaux bottles – hollow base.

Further details on the EPREL database. You can obtain the EPREL data sheet by contacting your ArteVino reseller.

* This wine cabinet is not available for the EU countries. ** Traditional Bordeaux bottles – hollow base.
Further details on the EPREL database. You can obtain the EPREL data sheet by contacting your ArteVino reseller.

ArteVino



www.artevino.fr/en

Specifications liable to change without notice. Photos non-binding
Photo credits: KatarzynaBialasiewicz, Nicolas Robin, NelleG, Rilueda
04/2021 – Eurocave Group - 24 rue Francis de Pressensé - 69628 Villeurbanne cedex
Commercial registration no. Lyon B320316995