

User Manual ProfiDrum Rotary Drum Filter (RDF)

June 2016

Version 2.00



ProfiDrum BV
Lopikerkapel Nederland

User Manual ProfiDrum Rotary Drum Filter (RDF)

Copyright © 2016 by ProfiDrum BV Lopikerkapel

All rights reserved. This document or any portion thereof may not be reproduced or used in any manner whatsoever without the express written permission of ProfiDrum.

First Release, 2012

User Manual ProfiDrum Rotary Drum Filter (RDF)

Document Revisions

Date	Version Number	Document Changes
June 2016	2.0	Refreshed Release and document control

Table of Contents

1	Introduction	5
1.1	... <i>Factory information</i>	5
1.2	... <i>Content of the package</i>	6
1.3	... <i>Guarantee and alterations</i>	6
2	Important warning signs	8
3	Identification	10
4	Installing your drumfilter in gravity setup	12
5	Installing your filter in a pump-fed setup	15
6	Connecting the waste tray	17
7	Connecting the high pressure pump and spraybar	18
7.1	... <i>Connecting the high pressure pump to the inlet of the drum</i>	18
7.2	... <i>Connecting the spraybar on the high pressure pump</i>	19
8	Inside the control unit	20
8.1	... <i>Connecting the wires to the control unit</i>	23
8.2	... <i>Connecting and installing the probe(s)</i>	23
8.2.1	Wiring the probe	24
8.2.2	Installing the probe	24
8.2.3	Typical Probe installation in a gravity setup	24
8.2.4	Understanding the Cleaning timer	25
8.2.5	Understanding the Low Level Protection	26
9	Initial Startup	28
10	Information resources	29

1 Introduction

Congratulations with the purchase of your ProfiDrum filter!

With the purchase of the ProfiDrum filter you now own a high quality product which was built with the utmost care and precision.

Please read carefully and follow all instructions and tips before you install the ProfiDrum Rotary Drum Filter.

This manual is a simple guide to installing your ProfiDrum Rotary Drum Filter, if you have any questions please do not hesitate to contact your dealer.

We recommend making a copy of the manual to keep in the immediate vicinity of your drum filter.

Please read and understand these instructions before attempting to install your ProfiDrum Rotary Drum Filter.

1.1 Factory information

Manufacturer

ProfiDrum Holland

Sluisweg 5

3412 LA Lopik

Model Type: ProfiDrum Eco and Stainless model 45/55/65/65E/75E

Applied CE Directives:

- New Machinery Directive (2006/42/EC)
- Low Voltage Directive (2006/95/EC)
- EMC Directive (2004/108/EC)

Applied standards:

- NEN-EN-ISO 12100-1
- NEN-EN-IEC 60204-1

The manufacturer declares to have complied with the safety requirements which are determined from the safety requirements of the Machinery Directive. This product also overlaps with the safety requirements from the LVD and EMC directives.

1.2 Content of the package

Your ProfiDrum Drumfilter is supplied with the following additional components:

- Controlbox
- High Pressure water pump
- Any additional items you might have ordered to implement the ProfiDrum

On receipt of your ProfiDrum please check for the following as we have no control over how the package is handled once it leaves the factory if transported by a third party:

- Any obvious damage to the protective packaging and contents of said package. Please immediately inform us of any damage
- All the nuts and bolts are secure
- The stainless steel drum's rim should be resting on the two nylon wheels on the bottom of the drum

1.3 Guarantee and alterations





Your ProfiDrum is guaranteed against any manufacturing faults on the Polypropylene or Stainless Steel parts for a period of two years, except for the panels.

Modifications to ProfiDrum RDF solutions and /or sensor solutions void your warranty. Not using original spare parts will void your warranty as well.

For any alterations to your ProfiDrum a written consent from the manufacturer is mandatory to be eligible for guarantee.

2 Important warning signs

Below you will find an overview of “Warning” and “Information” signs and their meaning, you will find them both in this manual as on our products:

	<p>WARNING / RECOMMENDATION / GUIDELINE</p> <p>This sign refers to warnings, recommendations and guidelines.</p>
	<p>ROTATING / MOVING PARTS</p> <p>Please ensure that all rotating parts including the internal fan are safe from contact while the motor is running. Operating the device with automatic restart can be a source of danger to operating personnel. After a power failure, the motor will start automatically if it was running when the power failure occurred.</p>
	<p>ELECTRICAL HAZARD</p> <p>Electrical shocks can cause death or serious physical injury to personnel as well as pose risk to equipment. Ensure that no unauthorized persons are able to gain access to or come into contact with the device. Disconnect the device from the power supply before opening the device or the terminal box. Due to DC-link capacitors, hazardous high voltage may remain for up to 3 minutes after disconnecting from the power supply. Never operate the device without the mains being correctly earthed.</p>
	<p>CORROSIVE SUBSTANCES</p> <p>Corrosive substances such as Hydrochloric Acid (HCl) may damage or destroy other substances including metals, skin tissue (chemical burns) and the eyes (possible permanent damage or even blindness). Hydrochloric Acid fumes may</p>

	damage the respiratory tract if inhaled.
--	--

3 Identification

Your ProfiDrum is equipped with a Polypropylene or Stainless steel housing (depending on the model). As the RDF in running model will be filled with water, it is important that it is placed on a flat surface supporting the drum.

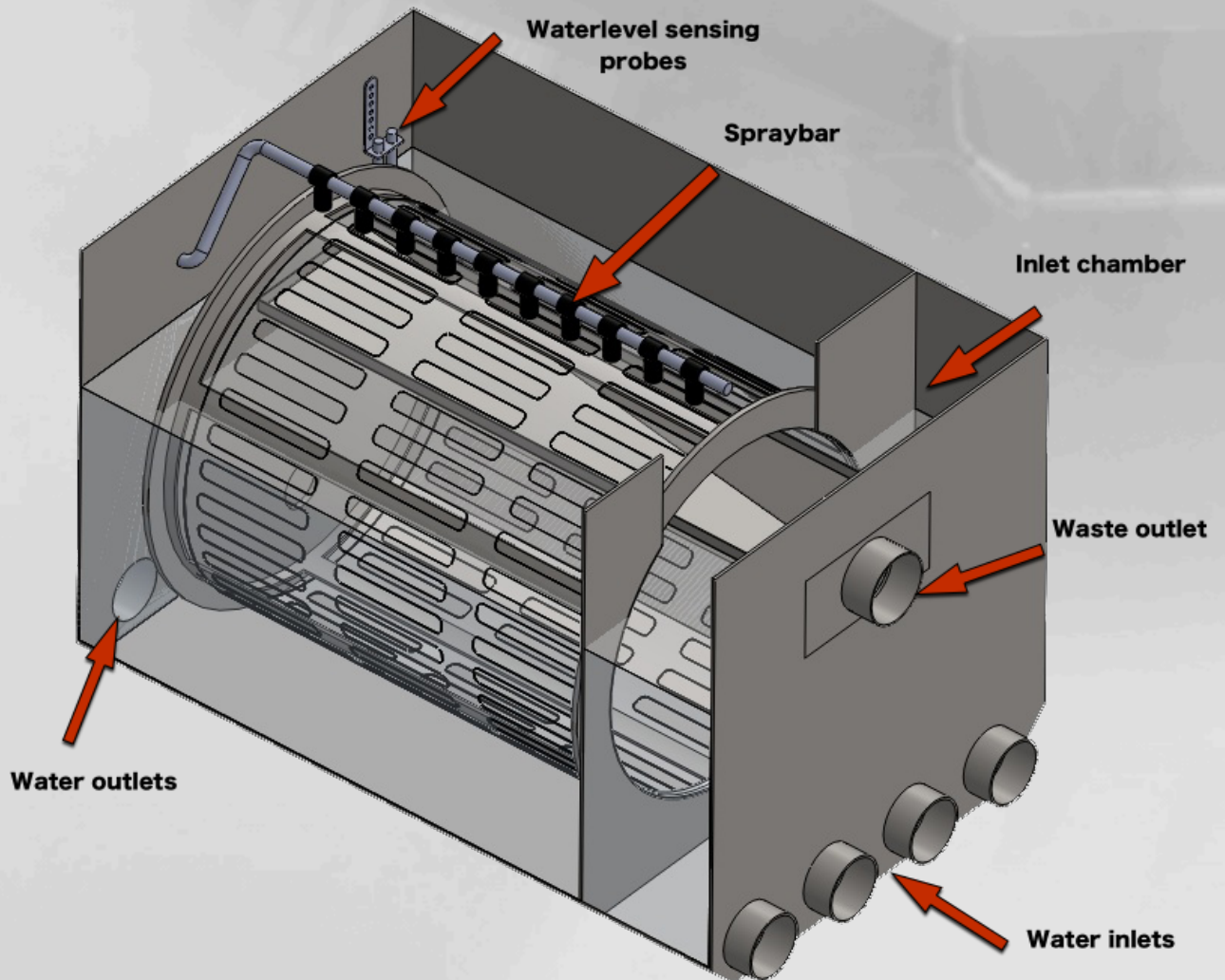

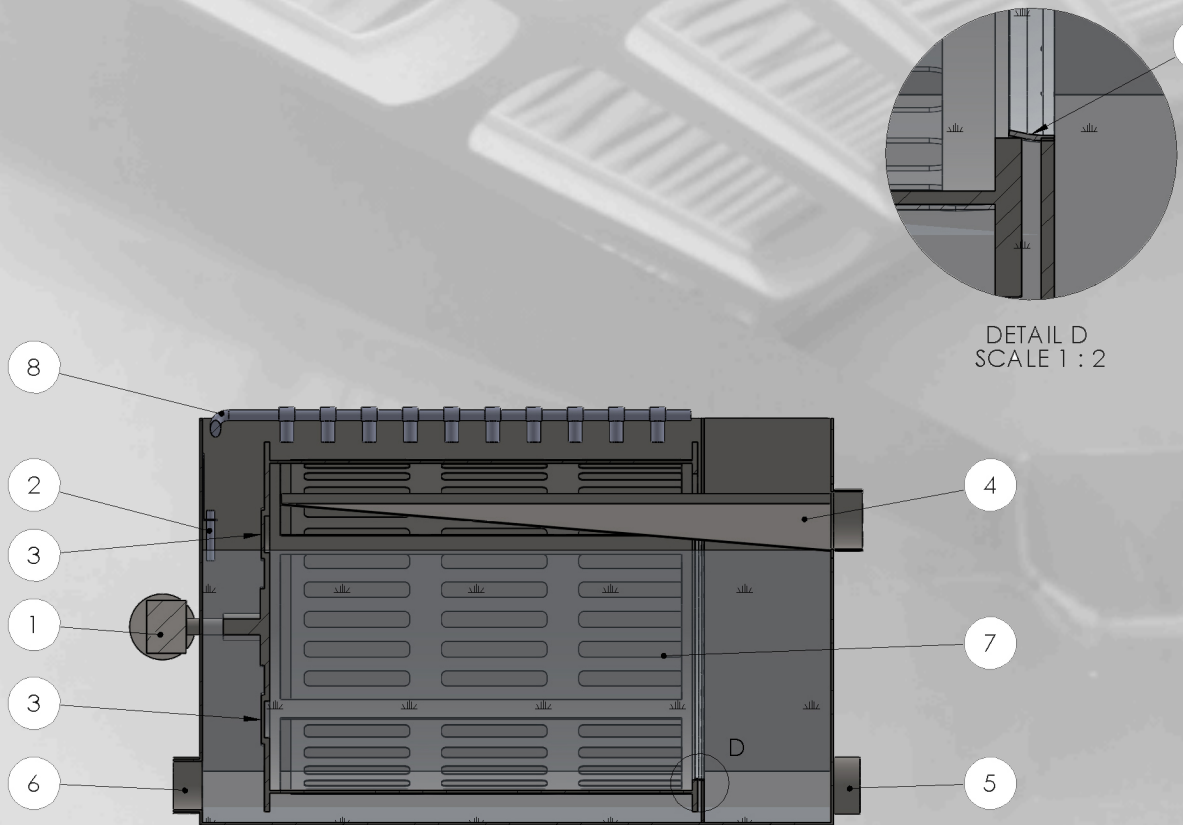



- 1 Drum motor
- 2 Sensor / Probe
- 3 Removable Bypass panels (number of panels varies per model)
- 4 Stainless Steel waste tray (4")
- 5 Water inlets, from pond (4", number varies per model)
- 6 Water outlets, to pump(s) (4", number varies per model)
- 7 Drum with panels (size varies per model)
- 8 Nozzles (number of nozzles varies per model)
- 9 Seal

4 Installing your drumfilter in gravity setup

Place the drum filter on a solid surface that is completely level. Set the drum so the top of the silicone seal is even with the static water level of the pond (pump(s) off).¹ By setting the water level at this height you use the most surface area of the screen in the drum filter.

You can then connect the inlet pipes from your pond, (Bottom Drains, Skimmers, Mid-Water), followed by the outlet pipes. The outlet pipe(s) can be connected directly to the pump(s) or directly to a Bio-filter (ie..moving bed). Both the inlets and outlets should be connected to your pipework with rubber couplers (Fernco's®). The size of the required coupler to connect to the drum is 4". It is advisable to place shut off valves on the inlet and outlet pipes. Depending on your set-up a check valve might be used on the outlet side in lieu of a valve.

	<p style="text-align: center;">*Electrical Hazard*</p> <p style="text-align: center;">Turn off the incoming power (Main) at the circuit breaker during installation</p>
	<p style="text-align: center;">The RDF contains components that rotate. Your ProfiDrum filter is equipped with a cover-protection, drum rotation and cleaning is NOT possible when the protection is initiated (cover is off)</p>

Set the drum so that the water level is even with the top of the silicone sealing strip. By setting the water level at this height you use the most surface area of the screen of the drum filter.



Water level adjustment

¹ This may cause a loss of water when the system is shut down depending on how high the Silicone Seal is above the top of the waste tray. While operating, “drawdown” within the filter eliminates further loss.

GRAVITY arrangement, not flush situation, probe touches water

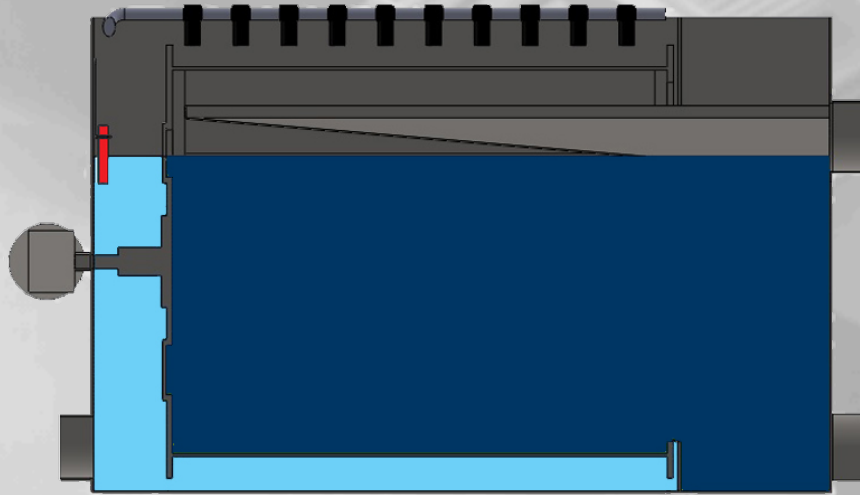

GRAVITY arrangement, flush situation, probe is dry

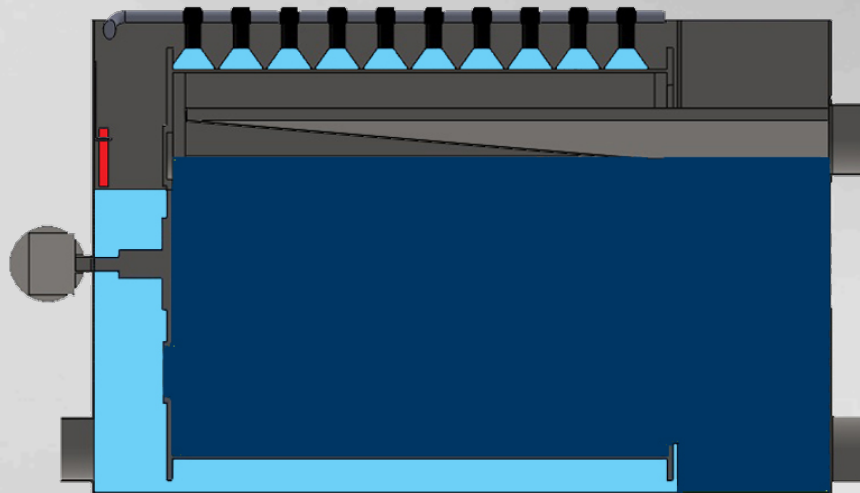

Dark blue is unfiltered water.

Light Blue is filtered water.

5 Installing your filter in a pump-fed setup

Your ProfiDrum will perform equally well in a Pump-Fed set-up with a few minor modifications.² Place your drum filter on a solid surface that is completely level.

You can then connect the inlet pipe(s) from your pump(s), followed by the outlet pipes. The outlet pipe(s) will need to exit the drum filter with a 90° elbow fitting oriented to flow upward. A second 90° elbow fitting is then required, bringing the outlet back to a horizontal path. The length of pipe between the two 90° elbows will be variable based on your particular flow rate and pipe sizing. Placing the top of the horizontal pipe 3" below the top edge of the waste tray is a good starting place. This configuration is needed to maintain a sufficient water level on the clean side of the drum. Both the inlets and outlets should be connected to your pipework with rubber couplers (Fernco's®). The size of the required coupler to connect to the drum is 4".

Pump-fed arrangement, not flush situation, probe is dry

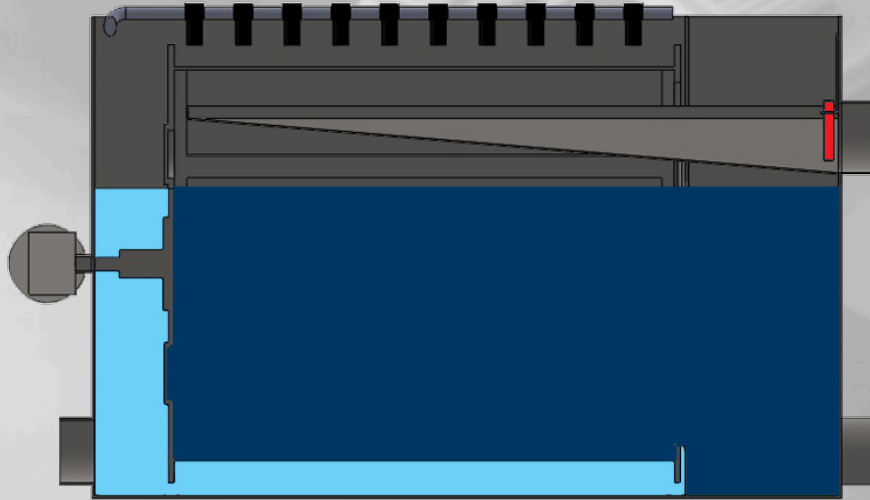

Pump-fed arrangement, not flush situation, probe touches water

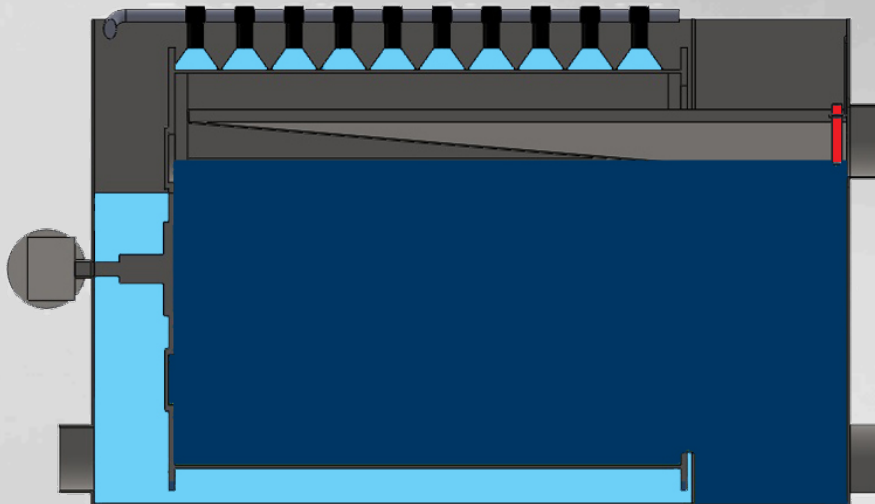

Dark blue is unfiltered water.

Light Blue is filtered water.

6 Connecting the waste tray

A 4" rubber coupler (Fernco's®) is also used to connect the waste tray to the sewer. The sewer can be an actual sewer pipe, or other proper drainage pipe. It is not recommended using a French Drain Line as debris will clog the piping. A small sump and submersible pump is also a possibility. If reducing the size of the waste line³ do not do so until the pipework is below the bottom of the waste tray. Not doing so can create a small dam that will trap a small amount of debris in the waste tray leading to unsatisfactory conditions.

7 Connecting the high pressure pump and spraybar

Your ProfiDrum filter is supplied with a High Pressure Pump to supply water to the cleaning spray bar. It is recommended to supply the High Pressure Pump with clean water from the “clean side” of the drum filter. This reduces the chances of the spray nozzles getting clogged.

The high pressure pump must be connected to the ½ inch connector of the spraybar.



To install the High Pressure pump use either a 1” bulkhead fitting or a 1” Uniseal® in the clean side of the filter tank. The connection to the spray bar is 1/2” MPT, reduce the 1” line at this connection with a reducing bushing.

7.1 Connecting the high pressure pump to the inlet of the drum.

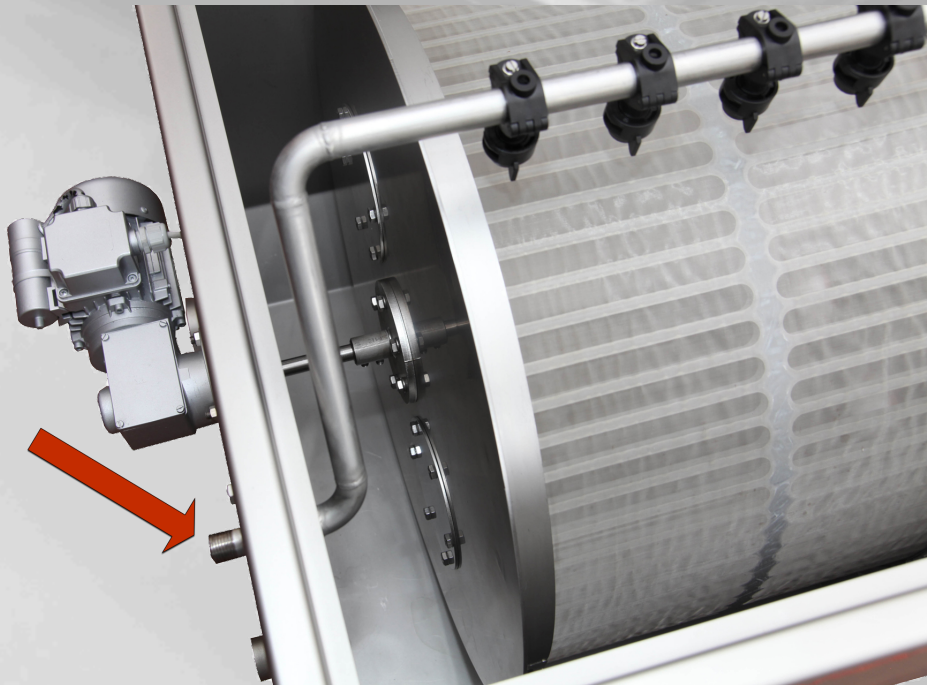

If you only work with a high pressure pump, connect the vertical inlet (suction side) of the high pressure pump (see picture pump) to the bottom of the drum 1 inch suction

inlet of the drum. It is not recommended to use less the 3" pipework for the waste line.



7.2 Connecting the spraybar on the high pressure pump

Then connect the discharge side of the high pressure pump to the spraybar. You work with a high pressure pump and therefore it is advisable to work with flexible hose. This prevents resonances in the pipes.

	<p>*Electrical Hazard*</p> <p>Turn off the incoming power (Main) at the circuit breaker during installation</p>
	<p><i>Suction side is located on the front of the pump.</i></p> <p><i>The compression side is located on the top side of the pump.</i></p>

8 Inside the control unit

Your ProfiDrum RDF is equipped with a control box that controls your filtration process:



At the front of the control box are:

- Main Power switch
- Automatic button for automatic cleaning (DEFAULT)
- Stop/reset Switch
- Manual/test Switch for manual cleaning

Inside the control box you will find the components to wire your Control Box including cable glands (strain reliefs), Probe(s) and a Ground Block

	<p>The filter will not clean automatically without the “Automatic” light on.</p>
---	---



Electrical Hazard

Turn off the incoming power (Main) at the circuit breaker during installation

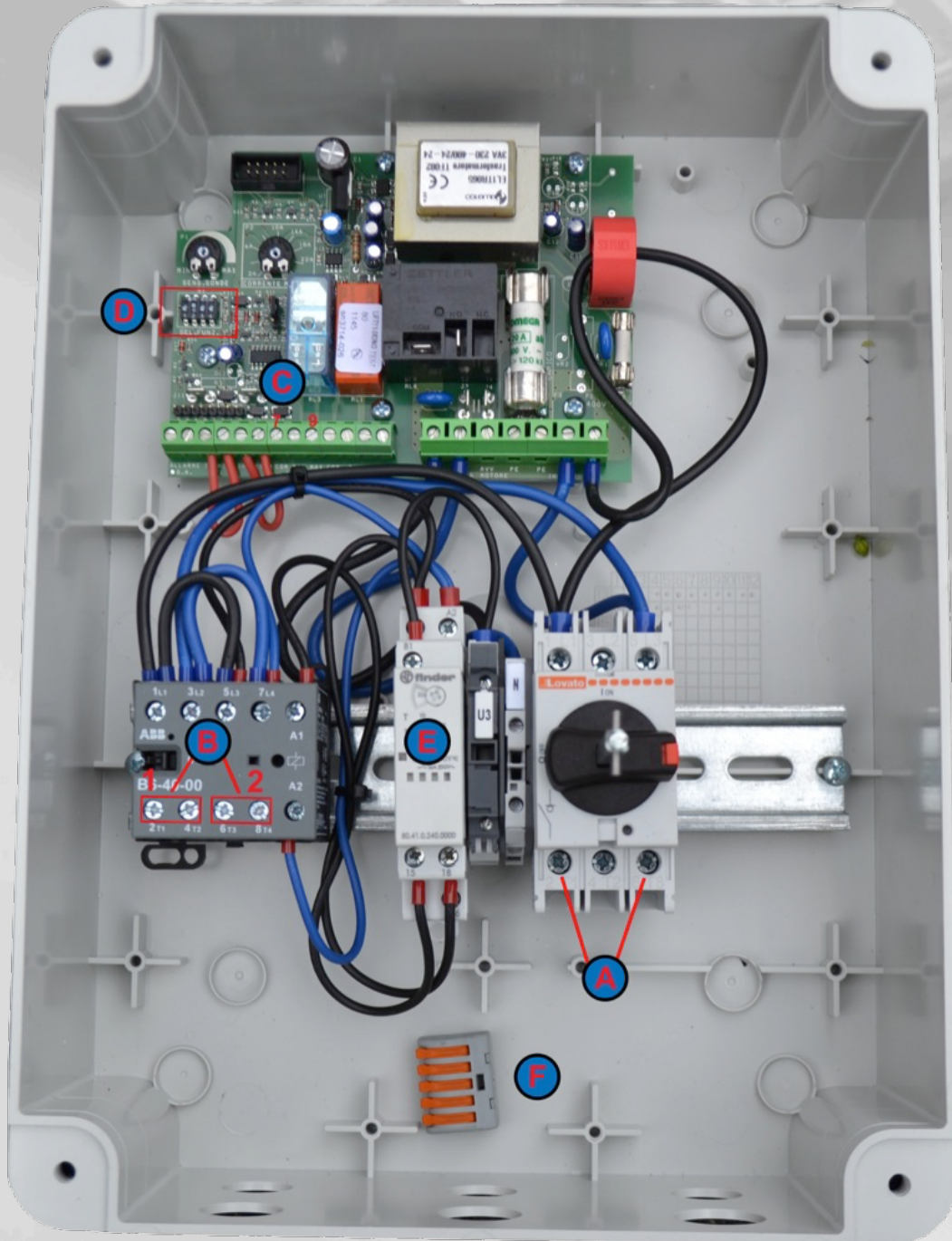

The internals of your control unit might look different, as components have been removed for demonstration purposes.

8.1 Connecting the wires to the control unit

- A. Connect Main Power here, line voltage (black) to the terminal “T1”, and neutral (white) to the terminal “T2”.
- B. Connect the Drum Motor at B1, line voltage (brown) to terminal “T1” and neutral (blue) to terminal “T2”, connect the High Pressure Pump⁴ to B2, line voltage (black) to terminal “T3”, neutral (white) to terminal “T4”.
- C. Connect wires⁵ from the Probes here (use 18AWG min.), one Probe to terminal 7 and one to terminal 9.
- D. Dip switch setting: When in Gravity Set-Up: 1-down, 2 up, 3 & 4 down. When in Pump Fed Set-Up: 1-up, 2, 3 & 4 down.
- E. Cleaning cycle timer relay.
- F. Ground Block. All Grounds connect to this block by lifting the orange tabs,
- G. inserting the wire, and fully depressing the orange tab. Connect your Circulation Pump (your pump that is pumping water to, or
- H. pulling water from the drum filter) here. Line voltage to U3 and neutral to N. Connect the wires from the Low Level Switch here.



Electrical Hazard

Turn off the incoming power (Main) at the circuit breaker during installation

8.2 Connecting and installing the probe(s)

Depending on your system, it is supplied with one or two probes. The installation position of the Probes will be determined by your set-up, either pump or gravity.

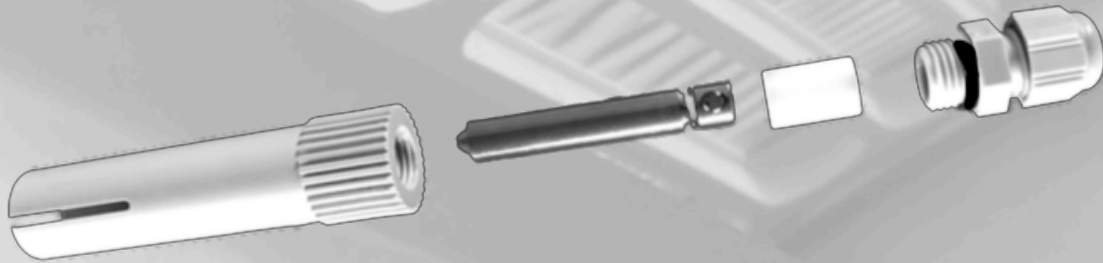

8.2.1 Wiring the probe

Begin by removing the cable gland (strain relief) from the top of the Probe, remove the spacer and Stainless Steel Probe from the housing. Using a minimum 18AWG wire, strip approximately 1/2" insulation from the end. Thread the wire through the cable gland and spacer then insert into the end of the Stainless Steel Probe and tighten the two (2) set screws on each side of the probe. Insert the Stainless Steel Probe back into the housing, being careful the rubber o-ring stays in position, next the spacer, then the cable gland. Secure the cable gland tightly into the housing followed by tightening the top, securing the wire in place.

8.2.2 Installing the probe

When your filter is installed in a gravity set-up the Probes will be installed in the clean (outgoing) side of the filter. During normal operation the Probes will be submerged approximately 2" in the water. As debris is captured inside the drum, draw down within the clean side of the filter will cause the water level to drop. Once the water level drops below the bottom of the Probes a cleaning cycle will begin.

8.2.3 Typical Probe installation in a gravity setup

When your filter is installed in a pump fed set-up the Probes will be installed in the dirty (incoming) side of the filter. During normal operation the Probes are elevated in the mounting bracket with the bottom of the Probes approximately 2" above the water. As debris is collected inside the drum, the flow through the screen will be reduced causing

the water level on the dirty side to rise. When the water level rises enough to make contact with both Probes the cleaning cycle will be initiated.

Care must be taken when establishing the height of the Probes when using your filter in a pump fed set-up. The bottom of both Probes must be below the LLP float switch



8.2.4 Understanding the Cleaning timer

The Cleaning Timer (E) controls the length of time the drum cleans, this includes how long the drum rotates and how long the High Pressure Pump sprays. There are two controls on the timer to set the cleaning time. The upper dial is a “macro” setting and the lower, blue dial is the “micro” setting. The upper (macro) dial indicates either 2s (2 seconds), 20s (20 seconds), 2m (2 minutes), 20m (20 minutes), 2h (2 hours), 24h (24 hours). The lower blue dial (micro) has a range from 1 to 2 (these numbers are arbitrary) and indicate the amount of time within the macro range.

For example: With the upper dial in the “2s” position, the lower blue dial will adjust the time from 1 second to 2 seconds. If the upper dial is in the “20s” position, the lower blue

dial will indicate from 1 second to 20 seconds. This relationship continues through all the ranges.

Filters are typically shipped with the Cleaning Timer set for 10 to 12 seconds. This allows for a complete rotation of the drum.

8.2.5 Understanding the Low Level Protection

The LLP Timer is located to the right of the main (on/off) switch (A) in the Control Box. The LLP Timer is set identically as the Cleaning Timer previously described. The LLP system protects your filter and circulation pump in a gravity fed set-up by shutting down the system in the event of a low water situation within the filter. In a pump fed set up the LLP works in reverse and keep the system from overflowing the waste tray

How the Low Level Protection System Works

With a gravity set-up, in the event of a low water level situation the system will be shut down when the float of the switch drops. As the correct water level is reestablished and the float rises to it's proper position the LLP Timer will start. In the event that the water level does not correct itself the system will remain off and the timer will not start.

Benefits of the LLP System

For example: For your filter to operate correctly a proper water level must be maintained. Occasionally it may be required to preform a major water change within your system. If changing enough water to allow the float switch to drop the system will shut off. As you re-fill your system, the float will rise and trigger the LLP Timer. There is a difference of approximately 1.5" between the float being in the upper (closed) position and the Probes. The LLP Timer should be set for a long enough time to refill your system so the Probes are in the water. This will depend on the rate of refill for your system. At the end of the time set on the LLP Timer the system start up again automatically.

LLP System in a Pump Fed Set Up

In a pump fed system the LLP will protect the system from overflowing the waste tray by shutting down the system in the event the filter does not clean properly.

To configure the LLP System in a Pump Fed Set Up begin by removing the small white disk at the top of the post that the float rides up and down on, remove the float from the post, flip it over and replace it on the post, then reinstall the white disk. This allows the float switch to operate in a “normally open” position. Install the float switch in the dirty

side (incoming) of the filter with the additional bracket provided by your Dealer. Position the float switch so the small white disk is approximately 1/4” below the top of the waste tray. Once your system is up and running this initial height can be adjusted to compliment your specific configuration.

9 Initial Startup

Regardless of how you've installed your filter, begin by filling the filter with water and checking for leaks. Turn on the Control Box by rotating the switch on the front of the box to the "ON" position. Insure that the "Power" light is on along with the "Automatic" light. Initiate a cleaning cycle by pressing the "Manual" button to check for proper operation.

By turning the red safety button on the front control box to the ON position to set the drum filter in operation



The filter will not clean automatically without the "Automatic" light on.

Intervals between the rinses

It is normal that the drum filter in the early stage of filtering frequently rinses. Unfortunately, there is no indication of why because this is highly dependent on the situation. The intervals between the rinse cycles are therefore largely determined by factors such as, pollution of the lake and its floating debris. Also, the surface of the drum in combination with the fineness of the mesh, have direct influence on the intervals between the flushing times. The intervals between the rinsing times may also vary due to the seasons.

Maintenance

It is advisable to periodically clean the screen with a hydrochloric acid solution <10. This maintenance should be done two to three times per year, but is strongly dependent on the situation. In general, if the intervals between the rinsing times become shorter, the cloth has to be cleaned.



Caution with hydrochloric acid. / It is corrosive, therefore always take the appropriate measures.

10 Information resources

More information about ProfiDrum and her products can be found at:

<http://www.profidrum.com>

Disclaimer

This document has been prepared with the utmost care. However, ProfiDrum accepts no liability for any inaccuracies within this document.

Please contact ProfiDrum or your dealer for any needed explanation or clarification of these instructions.

ProfiDrum is not liable for damages or injuries that occur as a result of not correctly following and/or neglect of the directions that are presented here in this manual.

All rights reserved to ProfiDrum

