



AquaMax *Eco Classic*
1200/1900/2700/3600

Operating instructions
Notice d'emploi
Instrucciones de uso



REMINDER

CALL 1-866-627-3435
BEFORE RETURNING TO STORE.

Information about these operating instructions

Welcome to OASE Living Water. You made a good choice with the purchase of this product **AquaMax Eco Classic 1200/1900/2700/3600**. Prior to commissioning the unit, please read the instructions of use carefully and fully familiarise yourself with the unit. Ensure that all work on and with this unit is only carried out in accordance with these instructions. Adhere to the safety information for the correct and safe use of the unit. Keep these instructions in a safe place! Please also hand over the instructions when passing the unit on to a new owner.

WARNINGS AND CAUTIONS SYMBOLS

Symbols used in these instructions

The symbols used in this operating manual have the following meanings:



Risk of injury to persons due to dangerous electrical voltage.

This symbol indicates an imminent danger, which can lead to death or severe injuries if the appropriate measures are not taken.



Risk of personal injury caused by a general source of danger.

This symbol indicates an imminent danger, which can lead to death or severe injuries if the appropriate measures are not taken.



Important! The unit is equipped with a permanent magnet. The magnetic field may affect the function of pacemakers.



Important information for trouble-free operation.

Intended use

AquaMax Eco Classic 1200/1900/2700/3600, referred to in the following as "unit", may only be used as specified in the following:

- For pumping normal pond water for filters, waterfalls and water courses.
- Operation under observance of the technical data.

The following restrictions apply to the unit:

- Do not use in swimming pools.
- Never use the unit to convey fluids other than water.
- Never run the unit without water.
- Do not use for commercial or industrial purposes.
- Do not use in conjunction with chemicals, foodstuff, easily flammable or explosive substances.
- Do not connect to the domestic water supply.

 **Important! The unit is equipped with a permanent magnet. The magnetic field may affect the function of pacemakers.**

Use other than that intended

This unit can be dangerous and cause harm if not used in accordance with these instructions. Any use not in accordance with these instructions or modification(s) to the unit will void the limited warranty.

WARNING

Risk of electric shock – This pump is supplied with a grounding conductor and grounding-type attachment plug. To reduce the risk of electric shock, be certain that it is connected only to a properly grounded, grounding-type receptacle.

Installation and connection

- ⚠ Attention! Dangerous electrical voltage.**
Possible consequences: Death or serious injuries due to operation of this unit in a swimming pond.
Protective measures:
- Do NOT use this unit in a swimming pond.
 - Adhere to national and regional regulations.

- ⚠ Attention! Dangerous electrical voltage.**
Possible consequences: Death or serious injuries.
Protective measures:
- Electrical units and installations with a rated voltage of $U > 12 \text{ V AC}$ or $U > 30 \text{ V DC}$ located in the water: Isolate the units and installations (switch off and disconnect from the power supply) before reaching into the water.
 - Isolate the unit before starting any work.
 - Secure the unit to prevent unintentional switching on.

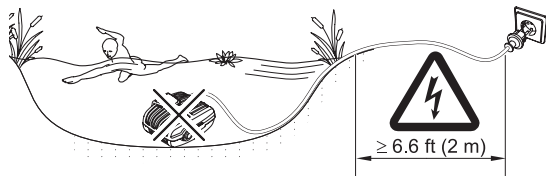
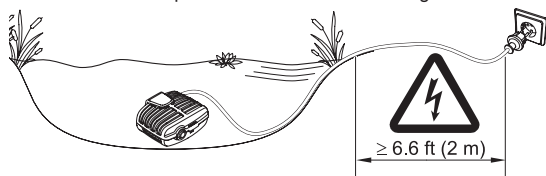

Important:

- The unit can be placed submerged or dry.
- Always place the unit below water level.
- It is recommended to place the unit horizontally on the ground ensuring its stable position.

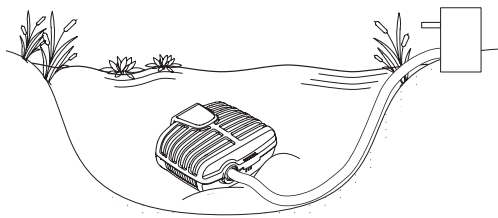

Operating the unit in the pond

The pump is in the pond. The return system, e.g. a pond filter, is connected to the pump outlet.

1. Screw the stepped hose adapter including union nut and sealing ring to the outlet.
2. Shorten the stepped hose adapter to the diameter of the hose used if necessary
 - This reduces pressure losses.
 - Align the stepped hose adapter prior to tightening the union nut.
3. Connect the hose with the stepped hose adapter and secure with a hose clip.

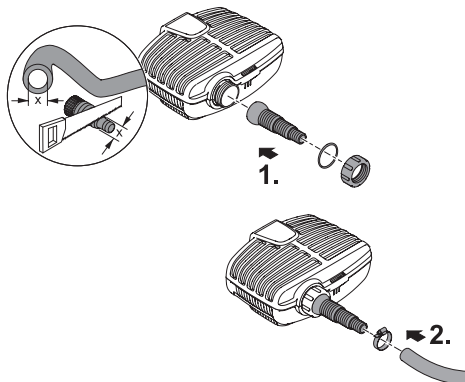

Questions, problems, missing parts?

Before returning to your retailer, call us at 1-866-627-3435, 8 a.m.-6 p.m., EST, Monday-Friday, or email us at customer-care@oase-livingwater.com. Or visit our website at www.oase-livingwater.com

Installation and connection

Install the unit at a dry place

Install the unit so that it is not exposed to direct sun radiation.

1. Remove screws.
 - The screws are used as transport protection and not required for operation.
2. Actuate the engagement hook and fold up the strainer top casing.
3. Remove pump.
4. Screw the stepped hose adapter including sealing ring onto the inlet.
5. Shorten the stepped hose adapter to the diameter of the hose used if necessary.
 - This reduces pressure losses.
6. Connect the hose with the stepped hose adapter and secure with a hose clip.
 - Align the stepped hose adapter prior to tightening the union nut.
7. Screw the stepped hose adapter including union nut and sealing ring to the outlet.
8. Shorten the stepped hose adapter to the diameter of the hose used if necessary.
 - This reduces pressure losses.
 - Align the stepped hose adapter prior to tightening the union nut.
9. Connect the hose with the stepped hose adapter and secure with a hose clip.

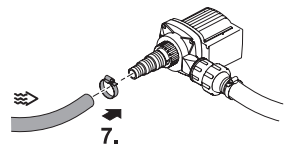
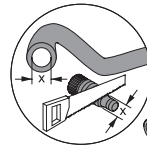
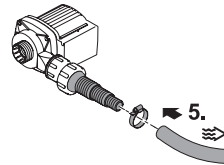
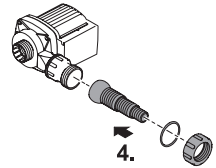
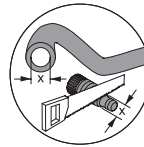
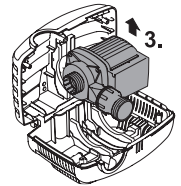
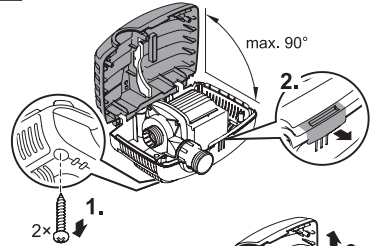
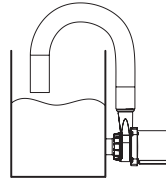

Start-up

- Attention! Sensitive electrical components.**
Possible consequences: The unit will be destroyed.
Protective measures: Do not connect the unit to a dimmable power supply.

This is how to connect the power supply:

- Switching on:** Connect the unit to the mains. The unit switches on as soon as the power connection is established.
- Switching off:** Disconnect the unit from the mains.

Important:

- When started up, the pump automatically performs a pre-programmed self-test of approx. two minutes length (**Environmental Function Control (EFC)**). The pump detects if it is running dry / blocked or submerged. The pump switches off automatically after approx. 90 seconds if it runs dry (is blocked). In the event of a malfunction, disconnect the power supply and flood the pump or remove the obstacle. Following this, the unit can be restarted.

Maintenance and cleaning

- Attention! Dangerous electrical voltage.**
Possible consequences: Death or serious injuries.

Protective measures:

- Electrical units and installations with a rated voltage of $U > 12\text{ V AC}$ or $U > 30\text{ V DC}$ located in the water: Isolate the units and installations (switch off and disconnect from the power supply) before reaching into the water.
- Isolate the unit before starting any work.
- Secure the unit to prevent unintentional switching on.

Cleaning the unit

- Note!**
Recommendation on regular cleaning:
 - Clean the pump at least twice a year.

- Never use aggressive cleaning agents or chemical solutions. These could attack the housing surface or impair the function.
- Recommended cleaning agent for removing stubborn limescale deposits:
 - Vinegar- and chlorine-free household cleaning agent.
- After cleaning, thoroughly rinse all parts in clean water.

Clean the pump

- Screw off the stepped hose adapter.
- Remove screws.
 - The screws are used as transport protection and not required for operation.
- Actuate the engagement hook and fold up the strainer top casing.

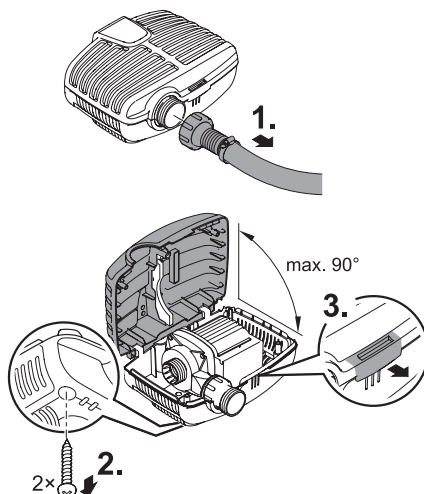

Questions, problems, missing parts?

Before returning to your retailer, call us at 1-866-627-3435, 8 a.m.-6 p.m., EST, Monday-Friday, or email us at customer-care@oase-livingwater.com. Or visit our website at www.oase-livingwater.com

Clean the pump

4. Remove pump.

5. Remove screws.

6. Remove the pump housing including its holding ring, sealing and impeller unit.

- Clean all components under running water using a soft brush, replace damage parts.

7. Reassemble the unit in the reverse order.

- Place the pump cable into the cable opening of the bottom strainer casing such that the cable will not be crushed when closing the filter housing.

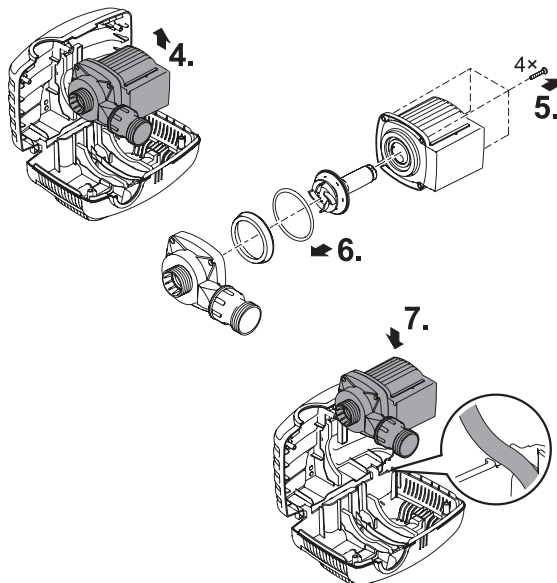

Storage/Winterization

- Remove the unit at temperatures below zero degrees centigrade. Thoroughly clean and check the unit for damage.
- Store the unit immersed in water or filled with water in a frost-free place. Do not flood the power plug!



Wear parts

The impeller unit is a wearing part and does not fall under the warranty.

Repair

A damaged unit cannot be repaired and must be put out of operation. Dispose of the unit in accordance with the regulations.

Disposal



Do not dispose of this unit with domestic waste! Disable the unit beforehand by cutting off the cables. Further information about the recycling of this product can be obtained from your local municipal authority.







Troubleshooting

Issue	Cause	Solution
Pump does not start	No mains voltage	Check mains voltage; Check supply lines
Pump does not deliver	Filter housing clogged	Clean strainer casings
Insufficient delivered quantity	Filter housing clogged	Clean strainer casings
	Excessive loss in the supply lines	<ul style="list-style-type: none"> – Select larger hose diameter – Adapt stepped hose adapter to hose diameter – Reduce hose length to reduce frictional loss – Avoid unnecessary connection elements
Pump switches off after a short running period	Excessively soiled water	Clean pump. The pump automatically switches on again once the motor has cooled down.
	Water temperature too high	Note maximum water temperature of 95 °F (+35 °C). The pump automatically switches on again once the motor has cooled down
	Pump has run dry	Flood pump. Fully submerge the unit when operated in the pond.
	Impeller unit blocked	Disconnect the power supply and remove obstacle. Then switch the pump on again.

Questions, problems, missing parts?

Before returning to your retailer, call us at 1-866-627-3435, 8 a.m.-6 p.m., EST, Monday-Friday, or email us at customer-care@oase-livingwater.com. Or visit our website at www.oase-livingwater.com

EN	Model	Model No.	Rated voltage	Power consumption	Max. flow rate	Max. head height	Immerision depth	Cord length	Weight	Water temperature	Connection for hoses	Dimensions
FR	Modèle	Numéro de modèle	Tension nominale	Consommation électrique	Capacité de débit	Hauteur maximale de la tête	Profondeur d'immersion	Longueur du cordon	Poids	Température de l'eau	Branchement pour flexibles	Dimension
ES	Modelo	No. de modelo	Tensión nominal	Consumo eléctrico	Tasa de flujo máxima	Columna de agua	Profundidad de inmersión	Longitud de cable	Peso	Temperatura del agua	Conexiones para tubería	Dimensiones
AquaMax Eco Classic	1200	40347	120V AC / 60 Hz	45 W / max. 1.3 A	≤ 1,200 gph ≤ 4,560 l/h	≤ 8.2 ft ≤ 2.5 m	max. 13 ft max. 4 m	20 ft 6 m	9.7 lbs 4.4 kg	39 ... 95 °F +4 ... +35 °C	1" / 1-1/4" / 1-1/2" 25 / 32 / 38 mm	11 x 9 x 5.5 in. 279 x 230 x 140 mm
	1900	57620		70 W / max. 1.4 A	≤ 1,900 gph ≤ 7,200 l/h	≤ 9.5 ft ≤ 2.9 m			11 lbs 5 kg			
	2700	57621		110 W / max. 1.5 A	≤ 2,700 gph ≤ 10,200 l/h	≤ 10.8 ft ≤ 3.3 m						
	3600	57623		150 W / max. 1.8 A	≤ 3,600 gph ≤ 13,700 l/h	≤ 13 ft ≤ 4 m						

	IP 68  13.3 ft 4 m					
EN	Dust tight. Submersible 13.3 ft (4 m) depth.	Remove the unit at temperatures below zero (centigrade)	Possible hazard for persons wearing pace makers!	Protect from direct sun radiation	Do not dispose or together with household waste!	Attention! Read the operating instructions
FR	Imperméable aux poussières. Élanche à l'eau jusqu'à une profondeur de 13.3 ft (4 m).	Retirer l'appareil en cas de gel.	Dangers possibles pour des personnes ayant des stimulateurs cardiaques !	Protéger contre les rayons directs du soleil	Ne pas recycler dans les ordures ménagères !	Attention ! Lire la notice d'emploi
ES	A prueba de polvo. Impermeable al agua hasta 13.3 ft (4 m) de profundidad	Desinstale el equipo en caso de heladas.	Posibles peligros para las personas con marcapasos.	Protéjase contra la radiación directa del sol	¡No deseches el equipo en la basura doméstica!	¡Atención! Lea las instrucciones de uso

AquaMax Eco Classic				
Pos.	1200	1900	2700	3600
1	21904	21904	21904	21904
2	21906	21906	21907	21907
3	21902	21902	21902	21902
4	40760	22817	21914	21914
5	40761	22818	22836	22837
6	10143	10143	10143	10143

