



Crystal Quest® Point-of-Entry (POE) Whole House Water Filter System INSTALLATION AND OPERATION GUIDE



ONLINE WARRANTY INFORMATION
CrystalQuest.com/warranty.html

Copyright 2020
Crystal Quest®
All rights reserved
MADE IN THE USA





IMPORTANT INFORMATION

Installation must be made within an area protected from the elements and freezing. The unit must be protected from rain, dust, flooding, snow, freezing, and direct sunlight (the system's exposure to direct sunlight may cause algae growth). Failure to comply will void the warranty.

- Do not run ½" I.D. semi-rigid drain tube more than 20 running feet. If over 20 ft., increase drain line tubing size to ¾" I.D. for the entire length of tube.
- Have control valve set correctly for your specific water needs.
- If more than one unit is being installed, the regeneration/backwash times should be staggered.
- A pressure regulator, such as a slow-flow regulator, must be installed in front of the unit's water inlet if the water pressure (including any possible pressure spikes) could exceed 60 psi. The most common operating water pressure range is 35-65 psi. Failure to comply will void the warranty. **Crystal Quest® assumes no liability for damage caused by excessive water pressure.**
- Check all the connections (i.e., water hose/tubing, connectors/fittings) to ensure proper connection and to avoid leaks.
- The filter cartridges used with this system have a limited service life. Changes in taste, odor, color, and/or flow of the water indicate that the cartridge should be replaced. Change cartridges routinely.
- After prolonged periods of non-use (such as during a vacation), it is recommended that the system be flushed thoroughly. Let water run for 10-20 minutes before using.
- Do not use metal fittings on plastic pipes.
- Check plumbing inlet and outlet to ensure the proper flow of water through the system.
- Plug system into a 110-volt outlet which contains a fuse or circuit breaker of 20 amps.
- Locate the system near a cold water supply line. Do not set the system farther than 15 ft. from the cold water line.
- Do not use the system on cold water supply line with less than 20 psi.
- Do not use the system where water is microbiologically unsafe or with water of unknown quality.
- All water treatment installations must conform to local plumbing, electrical and sanitation codes. These codes are established for your protection. Check with your local public works department for current plumbing codes.
- Installation errors can cause property damage. **Crystal Quest® assumes no liability whatsoever for systems improperly installed or those installed by someone other than a licensed plumber or qualified contractor. A leak detector valve is recommended to avoid accidental property damage. See page 13.**
- The contaminants or other substances removed or reduced by the selected cartridge(s) are not necessarily in your water. Ask your local water municipality for a copy of their water analysis, or have your water tested by a reputable water lab.
- Do not use non-Crystal Quest® replacement cartridges.
- Do not use non-Crystal Quest® parts or modify/tamper with unit.



! SAFETY PRECAUTION

Read all instructions, specifications, cautions, and warnings before installing and using your water filter system. Learn the specific details regarding installation and use. Failure to follow them could cause serious property damage.

Installation errors can cause property damage. All equipment needs to be plumbed into the water system by a licensed plumber.

These guidelines must be followed during system installation:

- Use the system on a potable, safe-to-drink, COLD water supply only. Do not use on hot water line.
- The system is for indoor use only.
- Turn the cold water line off while installing the system.
- When installation is completed, re-check the system to ensure there are no leaks or drips.
- The outlet must be within reach of the power cord. Do not use an extension cord. Extension cords that are too long or too light do not deliver sufficient voltage to the unit and could present a safety hazard.
- The rubber O-ring provides a watertight seal between the cap and the bottom of the housing. Make sure the O-ring is properly seated in the groove below the threads of the housing or a water leak could occur.
- Do not cross-thread fittings or housings. If cross-threaded, place the unit out of service.



Water testing by an independent third-party lab will attest to contamination removal and validity of toxicology testing. California residents are advised to have their water tested to ensure the water filter system is in compliance with Proposition 65.



TABLE OF CONTENTS

Important Information and Safety Precautions	2
Arrival, Unpacking, and Inspection	4
System Location	4
Installation Diagrams	5
Installing Optional UV Lamps	6
Assemble Water Filter System with Control Valve and Brine Tank (Mechanical and Automatic)	7
Programming Automatic Control Valve	8 - 13
Connecting Water Filter System to Water Supply	14
Connecting Pre- and Post-Filters to Water Supply	15
Connecting Tubing to Control Valve	16
Connecting Tubing to Brine Tank	17
How to Avoid Accidental Property Damage	18
Installing the Leak Detector Valve	18
Guide for Replacing Media	19
Replacing Filter Cartridges and Maintenance	20
Maintenance for Water Softeners	20
Troubleshooting	21
Frequently Asked Questions	22
One Year Limited Warranty	24
Ordering Replacement Cartridges	24

All drawings, pictures, colors and sizes are approximate for illustrative purposes only and may not exactly resemble the end product.

Read all instructions, specifications, cautions, and warnings before installing and using your water filter system.

INFORMATION & ASSISTANCE



WWW.CRYSTALQUEST.COM



CUSTOMER SERVICE
1-800-934-0051

Hours of Operation:
Monday to Friday
9 AM to 5 PM EST



SUPPORT@CRYSTALQUEST.COM

The system needs to be installed by a licensed plumber in any state or country. Specifically, the following states require a licensed plumber OR allow a *state-registered* installer or contractor to install your water filter system: AR, CA, GA, KS, MA, MI, MN, OK, RI, SC, SD, TX, VT, and WI.

Contact us for questions about your order, technical support and product information, or general comments or questions.

*Specifications are subject to change without notice.



ARRIVAL, UNPACKING, AND INSPECTION

- Inspect the carton and water filter for evidence of rough handling and concealed damages. If contents appear damaged, ask driver or contact the carrier for a damage claim form to fill out. Notify shipper immediately.
- Remove components from the shipping carton. Check that all installation parts are present, which includes the unit and installation hardware.
- Make a complete inspection of the system to ensure that:
 - a) there are no physical damages to the system,
 - b) all accessories are present,
 - c) and the system is clean and dust free.
- Pipe, shut-off valves, and fittings are not provided by Crystal Quest®.

CHECK LIST		WATER FILTER SYSTEM
<ul style="list-style-type: none"> • Unpack the water filter from the shipping box. • Unpack the control valve from the shipping box. 	✓	All Point of Entry Whole House models with backwashing and regeneration/backwash programming
<ul style="list-style-type: none"> • Unpack the water softener, tannin, or nitrate water filter system from the shipping box. 	✓	All Point of Entry Whole House models with regeneration/backwash programming
<ul style="list-style-type: none"> • Check the entire water filter system for any loss of parts. • Parts needed to install the water filter (control valve and softener) are packaged in a plastic bag. To avoid loss of the small parts, keep them packaged until you are ready to use them. Be sure not to discard components hidden in packaging. 	✓ ✓	All Point of Entry Whole House models with regeneration/backwash programming

Read all instructions carefully to learn the details for installing and using your P.O.E. water filter system. Failure to follow the Installation and Operation Guide could cause injury and/or property damage.

SYSTEM LOCATION

Select the location of your water filter system with care. For correct installation, refer to the appropriate diagram.

Various conditions which contribute to proper location are as follows:

- Do not locate the system where the environment would offer any risk of water contamination.
- Do not put any liquid other than water into the system.
- Position the water filter near main water supply line, drain and electrical outlet. Position so that main water supply shut-off valve is between water filter and main water source.
- Turn off the water flow to the house while installing system.
- Select location where floor is level. If floor is rough and/or uneven, you can level by placing tanks on 3/4" plywood, and shim to level as needed.
- Install the water filter by positioning it BEFORE the water heater.
- Water temperatures above 100°F (38°C) will damage the water filter. Use on cold water line only.
- Allow sufficient space around the installation area for easy servicing.
- Provide a non-switched 110/120V, 60Hz power source for the control valve (automatic/softener system).

TYPICAL INSTALLATIONS AND SYSTEM LOCATIONS (WITH BACKWASH OR REGENERATION FEATURES)

The system needs to be installed by a licensed plumber in any state or country. Specifically, the following states require a licensed plumber OR allow a state-registered installer or contractor to install your water filter system: AR, CA, GA, KS, MA, MI, MN, OK, RI, SC, SD, TX, VT, and WI.

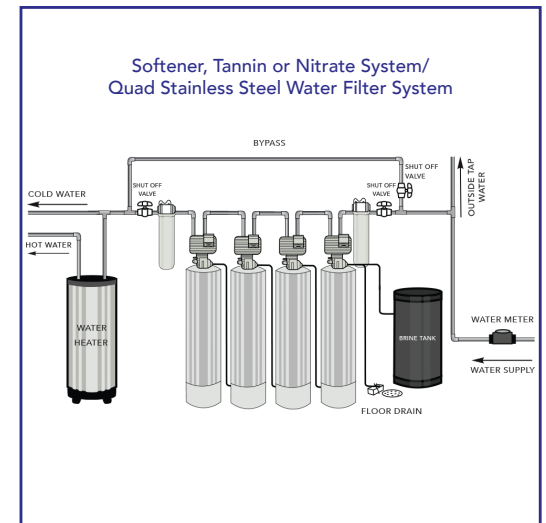
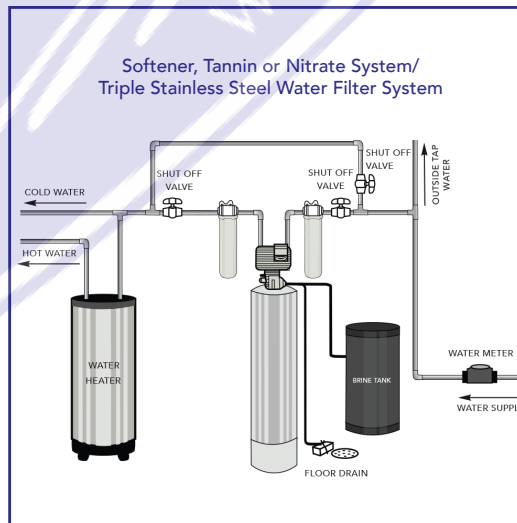
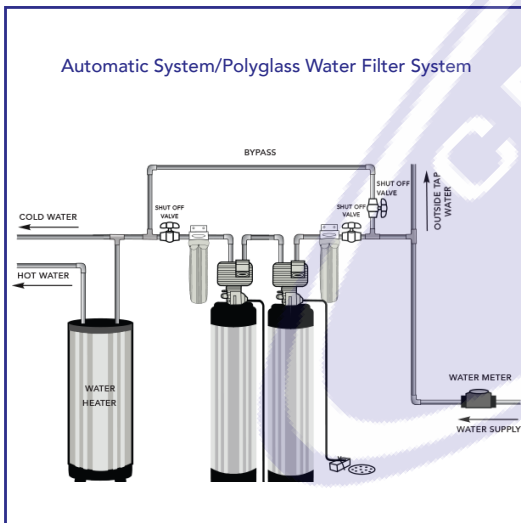
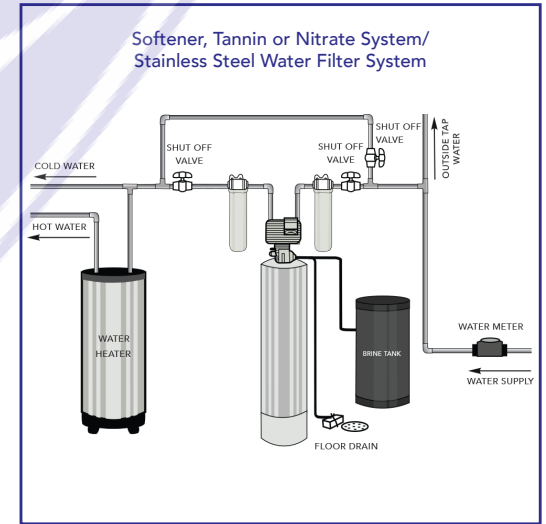
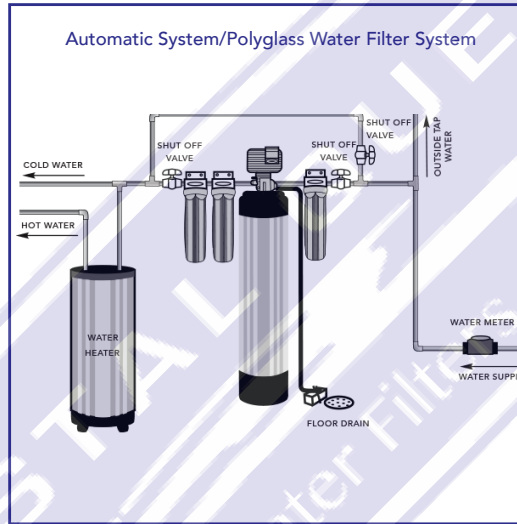
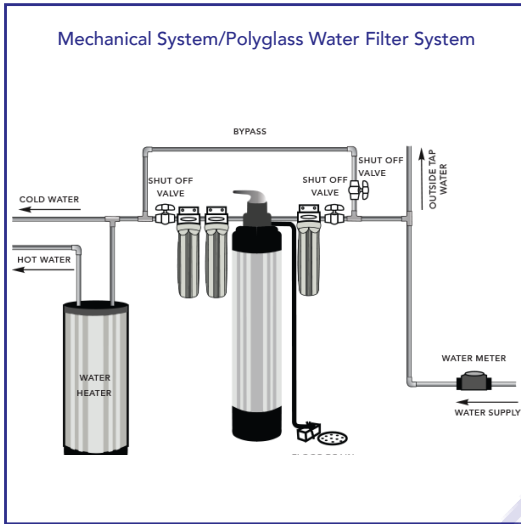

DOWNFLOW WITH NO BACKWASH WATER FILTER SYSTEMS

This system is ideal for acidic water conditions or as a post-filter for a reverse osmosis system to remineralize and enhance pH. This design will allow quick and easy media refill.

This system is great for well water and as an add-on to any whole house water filter. For detailed installation instructions, refer to the UV Installation and Operations Guide.

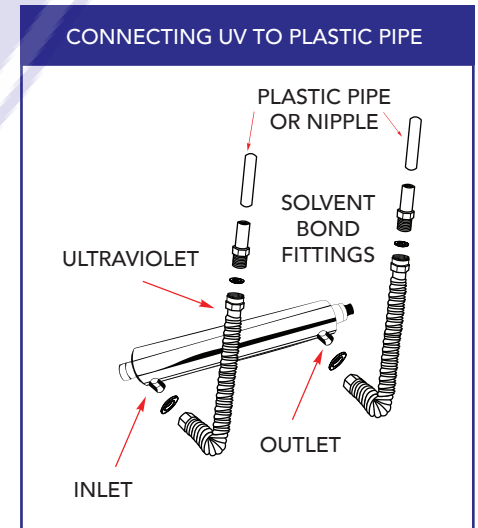
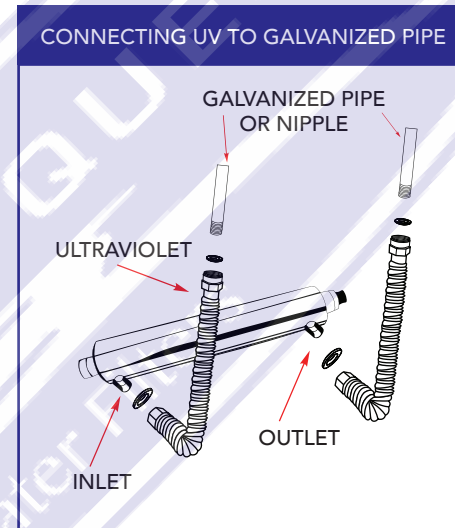
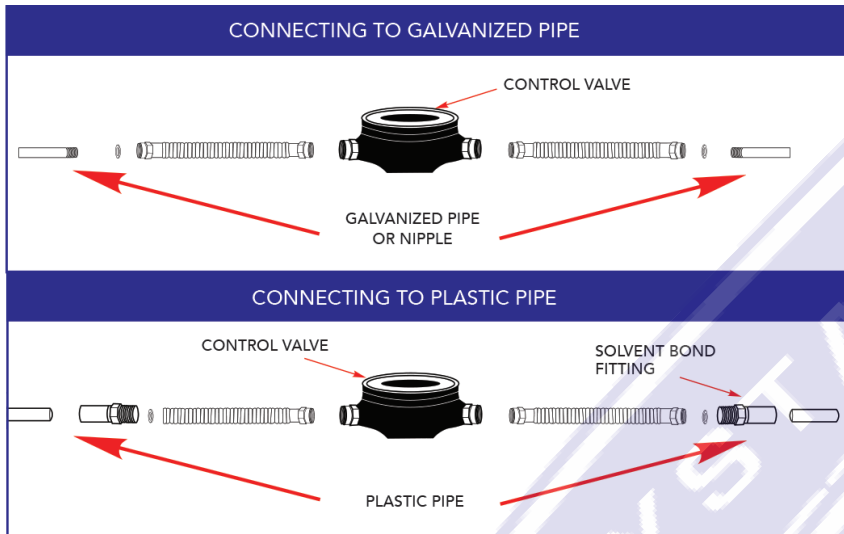

UV INSTALL HINTS

Refer to section "CONNECTING WATER FILTER SYSTEM TO WATER SUPPLY" for detailed instructions.

- Electronic ballast must be connected to a grounded outlet, and the lamp connector ground wire must be connected to the stainless steel reactor chamber.
- This disinfection system is designed to be mounted horizontally or vertically at the point of use or point of entry, depending on the specific flow rate of the unit.
- The UV disinfection system is intended for indoor use only.
- Do not install disinfection system where it may be exposed to the weather or temperatures above 100°F.

(UV PLACEMENT IS OPTIONAL BASED ON WATER FEED SOURCE)

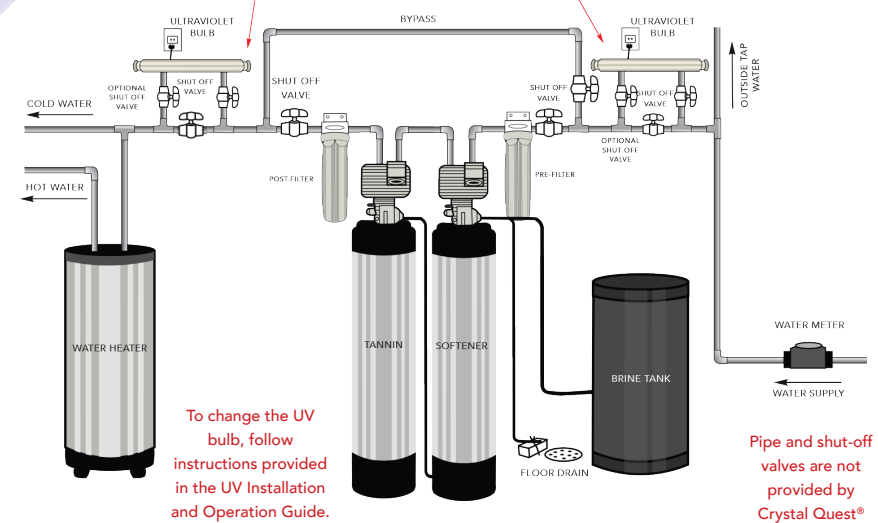

To change the UV bulb, follow instructions provided in the UV Installation and Operation Guide.

Pipe and shut-off valves are not provided by Crystal Quest®

DOWNFLOW WITH NO BACKWASH WATER FILTER SYSTEMS

Unpack the control valve from the shipping box. It is recommended that you keep the original boxes and packing materials.

<p align="center">1</p> <p>Unscrew and remove the top cap from unit.</p> 	<p align="center">2</p> <p>Unplug slip cap from the distributor/riser tube (also referred to as a PVC tube).</p>  <p>DISTRIBUTOR/ RISER TUBE SLIP CAP</p>	<p align="center">3</p> <p>To prevent leaks, lubricate the inner and outer O-rings on the bottom of control valve with food grade silicone lubricant.</p> 	<p align="center">4</p> <p>Twist and lock top distributor to the bottom of control valve. Ensure it is fully locked in place.</p>  <p>CONTROL VALVE TOP DISTRIBUTOR</p>
<p align="center">5</p> <p>Attach control valve to the tank by sliding distributor tube into top distributor. Turn control valve clockwise to tighten. Distributor tube needs to be equal to the top of the resin tank (not more than 1/4" above). Lubricate the inner O-ring prior to attaching the control valve to the tank.</p>  <p>CONTROL VALVE TOP DISTRIBUTOR DISTRIBUTOR TUBE O-RING TANK</p>	<p align="center">6</p> <p>Attach bypass valve to the back ports of the control valve by sliding the bypass over the O-rings and tighten (it is held in place by two metal clips and two screws).</p> 	<p align="center">7</p> <p>Attach drain line hose barb and compression nut of the brine tank by turning clockwise to tighten until snug. To prevent leaks, wrap threads of hose barb and compression nut with thread seal tape clockwise, approximately 3 times around.</p>  <p>DRAIN LINE HOSE BARB COMPRESSION NUT OF BRINE TANK</p>	

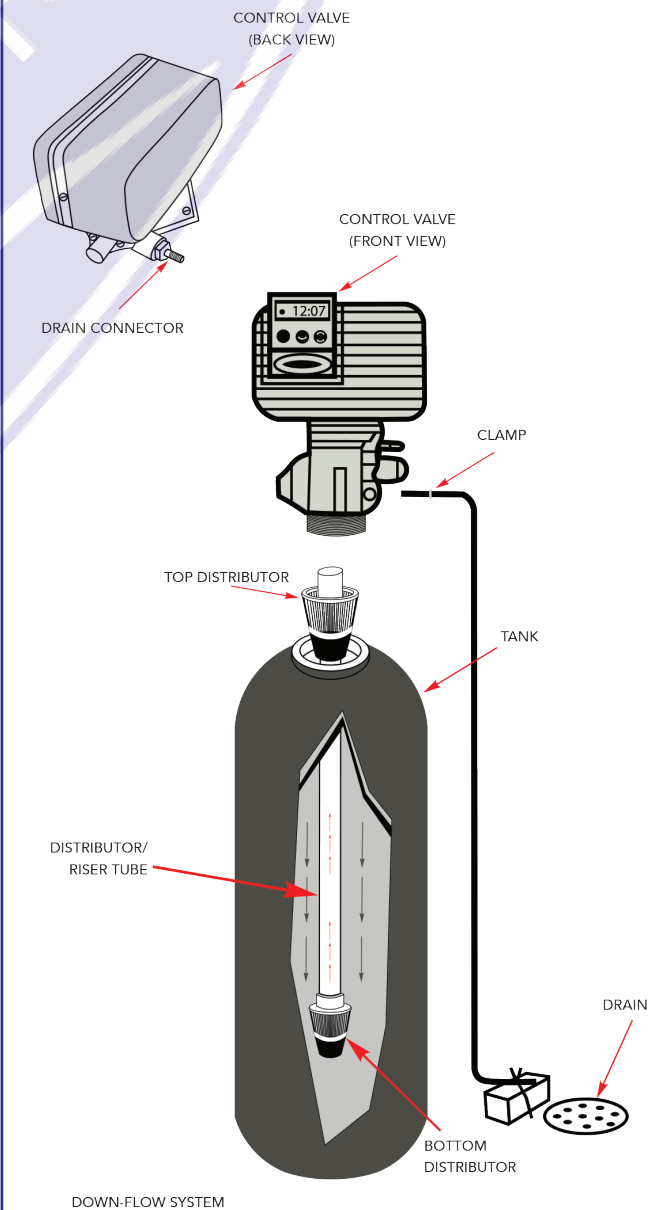

PROGRAMMING AUTOMATIC CONTROL VALVE

**Programming to Backwash and Regenerate
using an Automatic Valve**

(Refer to instructions on the next pages for programming Automatic Control Valve)

A1



A2



**Programming to Backwash
using the Mechanical Control Valve**

(See Instructions Below)

M1



M2



M3



- When programming the mechanical valve to backwash, firmly grip the handle, turning it counterclockwise from the service FILTER (M1) position.
- Lock the handle to the BACKWASH (M2) position.
- Allow the water to run through the unit for five minutes or until the water becomes clear and free of dust or media fines.
- Manually turn the control knob clockwise to the service FILTER (M3) position. Your unit is back in service and ready to operate.



PROGRAMMING TO BACKWASH NON-REGENERATION SYSTEMS ONCE EVERY 7 DAYS



1) Your control head comes set at **12:01 PM**. To continue you must be on 12:01 PM. Use the up or down arrows to set the time. Once the time is changed, push the Recycle button (refer to Figure A1) to lock it in.



3) Push Recycle button. Screen will read **"dF 1b"**. This is set at factory and will not need to be changed.

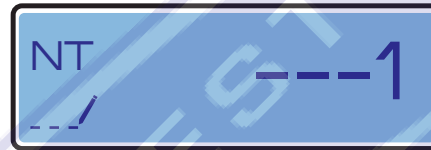

5) Push Recycle button. Screen will read **"NT ---1"**. This is the number of tanks the timer is controlling (one tank). Do not change this.



7) Push Recycle button. Screen should read **"RT 2:00"***. If not, use up/down arrow buttons to set to 2:00.

*If more than one tank is being used, regeneration time (**RT 2:00**) should be staggered for each tank.



2) Push and hold both arrow buttons until screen changes to read **"GAL"**.



4) Push Recycle button. Screen should read **"tc"**. If not, use up/down arrow buttons to set to "tc".



6) Push Recycle button. Screen should read **"DO 7"**. If not, use up/down arrow buttons to set number to 7.



8) Push Recycle button. Screen should read **"BW 10"**. If not, use up/down arrow buttons to set to 10.



PROGRAMMING TO BACKWASH NON-REGENERATION SYSTEMS ONCE EVERY 7 DAYS *CONTINUED*



9) Push Recycle button. Next screen will be "BD 60". Use down arrow to change screen to read "OFF". (Range between 199-OFF).



10) Push Recycle button. Screen will change to time display and programming is locked in.

After completing the setup of your Control Head and exiting the Settings Menu, be sure to set the Time Clock to your current time using the Up and Down arrow keys. Once your correct time is selected, press the Recycle Button once to lock it in. The Control Head will use the time set here as a basis for regulating your systems Backwash and Regeneration functions.



PROGRAMMING TO BACKWASH REGENERATION SYSTEMS ONCE EVERY 7 DAYS

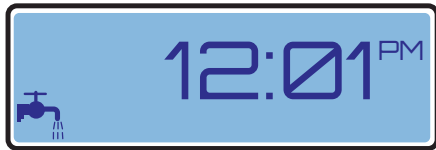

1) Your control head comes set at **12:01 PM**. To continue you must be on 12:01 PM. Use the up or down arrows to set the time. Once the time is changed, push the Recycle button (refer to Figure A1) to lock it in.



3) Push Recycle button. Screen will read **"dF 1b"**. This is set at factory and will not need to be changed.

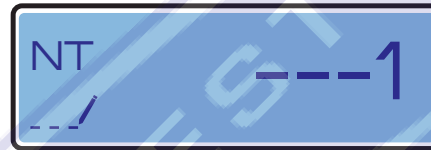

5) Push Recycle button. Screen will read **"NT ---1"**. This is the number of tanks the timer is controlling (one tank). Do not change this.



7) Push Recycle button. Screen should read **"RT 2:00"***. If not, use up/down arrow buttons to set to 2:00.

*If more than one tank is being used, regeneration time (RT 2:00) should be staggered for each tank.



2) Push and hold both arrow buttons until screen changes to read **"GAL"**.



4) Push Recycle button. Screen should read **"tc"**. If not, use up/down arrow buttons to set to "tc".



6) Push Recycle button. Screen should read **"DO 7"**. If not, use up/down arrow buttons to set number to 7.



8) Push Recycle button. Screen should read **"BW 10"**. If not, use up/down arrow buttons to set to 10.



PROGRAMMING TO BACKWASH REGENERATION SYSTEMS ONCE EVERY 7 DAYS *CONTINUED*



9) Push Recycle button. Next screen will be "BD 60". Use down arrow to change screen to read "OFF". (Range between 199-OFF).



10) Push Recycle button. Screen should read "RR 10". If not, use up/down arrow buttons to set to 10.



11) Push Recycle button. Screen should read "BF 12". If not, use up/down arrow buttons to set to 12



12) Push Recycle button. Screen will change to time display and programming is locked in.

After completing the setup of your Control Head and exiting the Settings Menu, be sure to set the Time Clock to your current time using the Up and Down arrow keys. Once your correct time is selected, press the Recycle Button once to lock it in. The Control Head will use the time set here as a basis for regulating your systems Backwash and Regeneration functions.



CONNECTING WATER FILTER SYSTEM TO WATER SUPPLY MECHANICAL/AUTOMATIC



MINIMUM MATERIALS NEEDED

- Turn off the main water shutoff valve.
- Open all plumbing fixtures in the house including all outside faucets in order to drain the lines of all water.
- Cut and remove a section of the main incoming water line near where the system is to be installed. Allow this line to drain thoroughly (Fig 8).
- If copper piping is used and soldered, remove the bypass from the valve assembly and attach your plumbing adapters to the bypass away from the valve. This simple step will ensure that you are not applying heat as you solder, or pressure as you tighten the adapters onto the bypass while they are mounted on the valve body itself.
- Solder a 3" to 5" piece of copper pipe into each of the two pipe adapters away from the valve, then let them cool before threading each one onto the yoke or bypass valve (Fig 9).
- Apply thread seal tape onto the male adapters for the brass bypass valve when cool, and securely tighten them to the bypass valve. This is done before reattaching them onto the rear of the valve/meter body assembly.
- Close main water supply shutoff valve.
- Open nearest faucet to relieve pressure and drain plumbing lines.

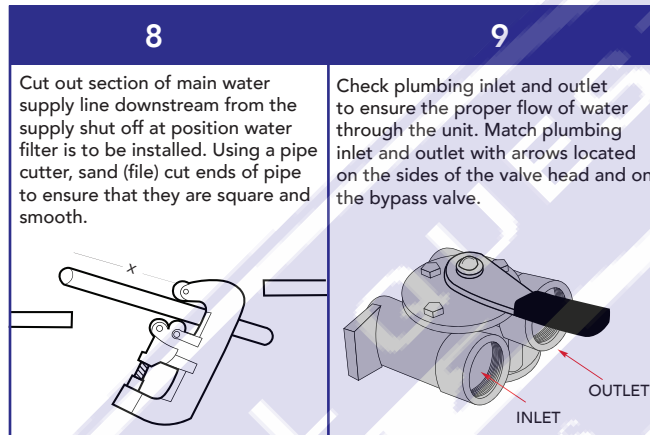

- 3/4" or 1" male thread adapters to plumb the system
- Wrenches, either open end or adjustable jaw, sized to fit compression adapters
- Pipe cutter
- Thread seal tape
- Sandpaper or emery cloth
- Before installing 3/4" or 1" fittings to the inlet and outlet of the bypass valve or manifold, wrap the threads 3 times around with thread seal tape. Install 3/4" or 1" fittings.
- Soldering is no longer required to plumb with copper pipe. Instead, use 3/4" or 1" compression fittings. Connect plumbing as shown below (Fig 10), choosing appropriate connection for mechanical/automatic control valve.

(Choose appropriate connection below)

CAUTION: Do not overtighten or cross-thread.
CAUTION: Install water filter in direction of arrows.

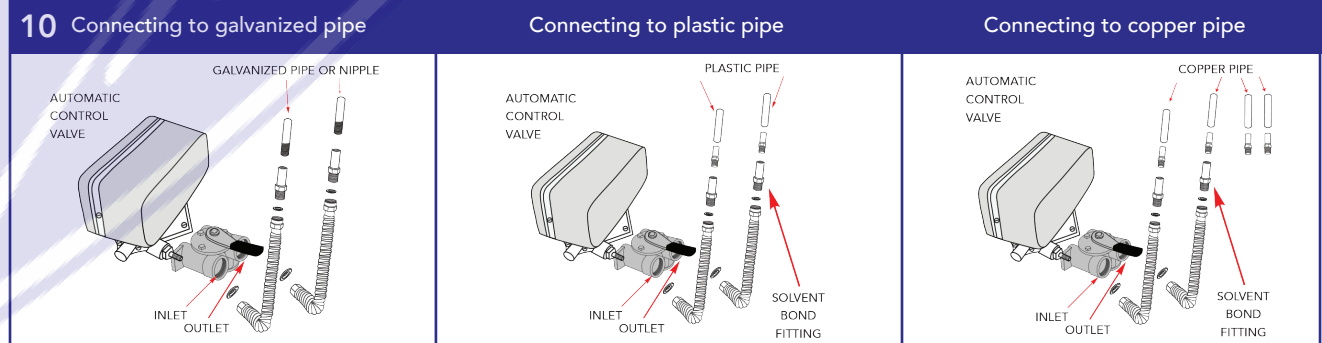



CONNECTING PRE- AND POST-FILTERS TO WATER SUPPLY

Pre-filter: Sediment Cartridge

Post-filter: Carbon Block (for EAGLE systems, the UltraFiltration Cartridge is Post-filter 2)

- Select a secure location surface to install filter and mounting bracket. The location should align the filter system with inlet and outlet pipe and should not cause the pipes to bend or get damaged. Mark the distance "X" on the pipe.
- The bracket can be used as a template for marking the location of the mounting screws (Figures 11 & 12).
- Use four hex washer-head screws to mount bracket firmly to wall. Use proper anchors on wall. Anchors and screws are NOT included.
- Apply 4 or 5 wraps of thread seal tape, in a clockwise direction, to the pipe threads of each fitting. DO NOT use joint compound on any parts connecting to filter housing.
- Turn fittings clockwise to tighten. DO NOT overtighten.

11

Turn off the water supply and open a nearby faucet to drain the water out of pipes. Using a tape measure or ruler, measure the distance "X" as shown.

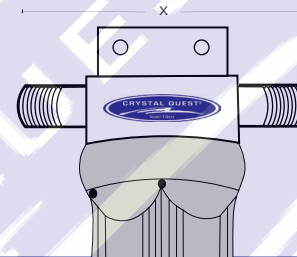

12

Using a pipe cutter, cut pipe. Sand (file) cut ends of pipe to assure that they are square and smooth.

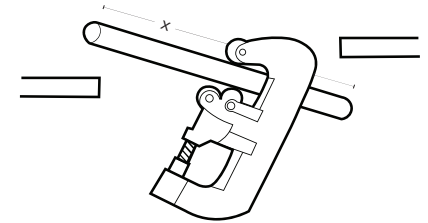

13 POLYPROPYLENE FILTER - Choose appropriate connection below

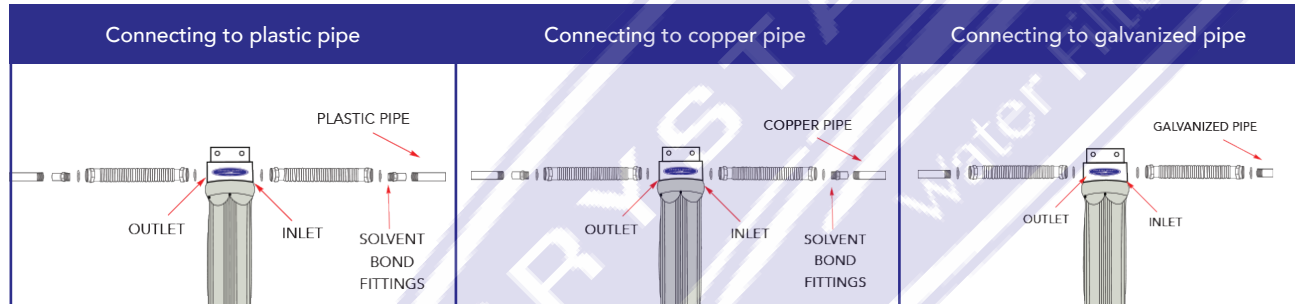

13 STAINLESS STEEL FILTER - Choose appropriate connection below

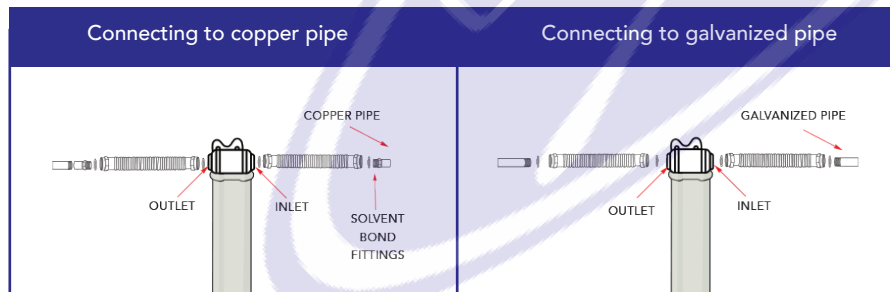

MINIMUM MATERIALS NEEDED

- Tape measure or ruler
- 4 hex washer-head screws
- Anchors
- Pipe cutter
- Thread seal tape
- Sandpaper or emery cloth
- Before installing 3/4" or 1" fittings to the inlet and outlet of the bypass valve or manifold, wrap the threads 3 times around with thread seal tape. Install 3/4" or 1" fittings.
- Soldering is no longer required to plumb with copper pipe. Instead, use 3/4" or 1" compression fittings. Connect fitting as shown below (Fig 13).

INSTALLING GROUND WIRE

IMPORTANT: A copper or galvanized cold water pipe is often used to ground electrical outlets in the home. Grounding protects you from electrical shock. The water filter housing may have broken this ground path. To restore connection, install an 18" long, 6-gauge copper wire across the filter, tightly clamped using UL approved 1/2"-1" bronze grounding clamps at both ends as shown. Zinc clamps should not be used on copper plumbing. Wire and clamps may be purchased separately from your local hardware store. With emery cloth, clean copper pipe and ends of wire. Bare wire is recommended. If insulated wire is used, it should be stripped 3/4" at each end before cleaning with emery cloth.

- Attach bronze clamps to pipe. Tighten screws.
- Attach wire to clamps as shown. Tighten screws.

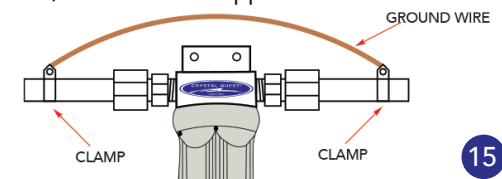

CONNECTING TUBING TO CONTROL VALVE - MECHANICAL AND AUTOMATIC

Press 1/2" I.D. semi-rigid or non-collapsible plastic tubing onto drain line hose barb until snug and secure with a hose clamp (Figs 14 and 15).

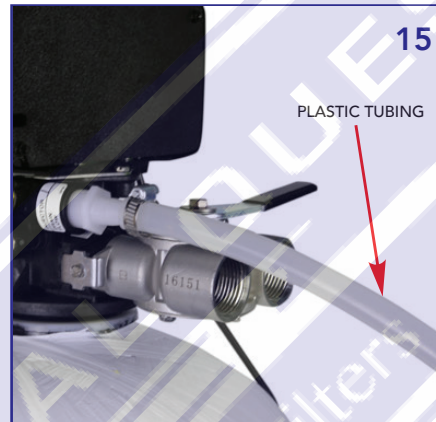

- Plug cord from control valve into 110V electrical outlet. Make certain that outlet is supplied with power at all times. Make sure area is dry before plugging the unit in (Fig 16). Open main water supply shutoff valve.
- **CHECK FOR LEAKS!** Close previously opened faucet.

NOTE: Do not run 1/2" drain line over 20'. If over 20', increase tube size to 3/4".

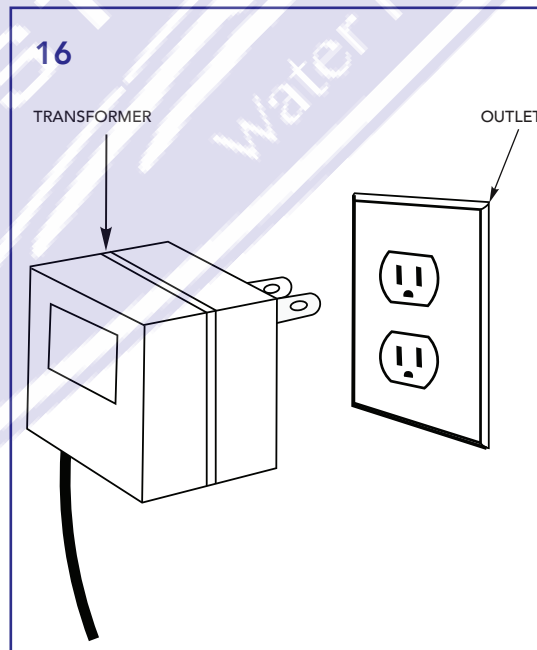

CONNECTING TUBING TO BRINE TANK

- Connect tubing to control valve as shown in Figures 14 and 15 for the mechanical and automatic water filter systems.
- For connecting tube to brine tank (softener, nitrate and tannin systems), see Fig 17 below:

- (1) Slide the brass insert into brine tube and slide compression nut onto brine tube.
- (2) Turn compression nut clockwise with wrench to tighten. **DO NOT OVERTIGHTEN.**

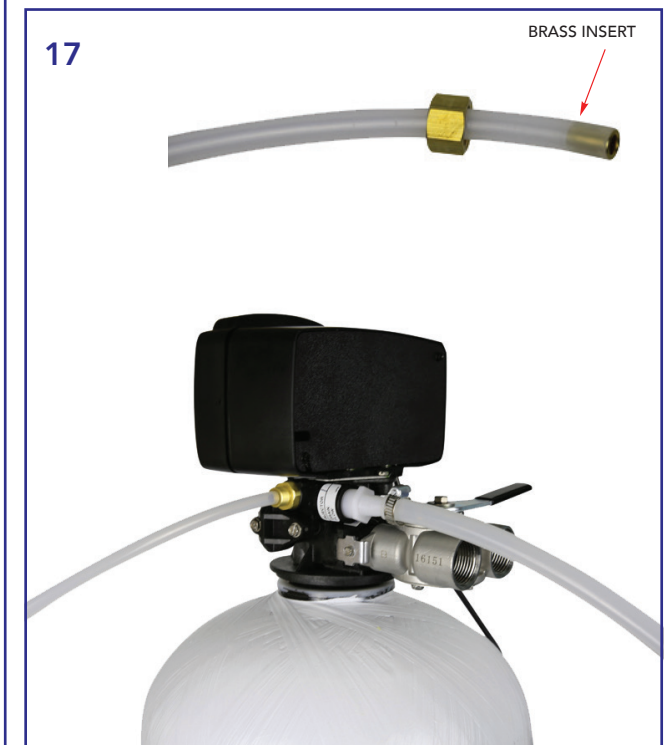



CONNECTING TUBING TO BRINE TANK

18

Remove the black brine tank lid.



19 and 20

Remove the small white lid from the inside of the brine tank. Lift out parts inside and unscrew bolt.



21

Thread the screw through the pre-made hole, and use the bolt to secure in place.



22 and 23

Remove the black plastic screw on opposite side and thread the hose through the tank.

Place the black screw and additional parts around the hose and then screw securely into place.



24

- Install 1/2" I.D. semi-rigid or non-collapsible tubing (not included) to the overflow hose barb located on the side of the softener brine tank and run to a suitable drain. Do not connect to drain line off of softener (Figs 22 & 23).
- Plug cord from control valve into 110V grounded electrical outlet. Make certain that outlet is supplied with power at all times. Make sure area is dry before plugging the unit in (Fig 25).
- Open main water supply shutoff valve. **CHECK FOR LEAKS!** Close previously opened faucet.
- Pour the 5-gallon bucket of water into the brine tank.
- Pour 1-1/2 oz. of chlorine bleach solution directly into the brine tank or salt/potassium permanganate compartment.
- Pour salt or potassium permanganate into brine tank component (not included). Fill tank 1/2 - 3/4 full (do not pack full) and add water until it is just above the salt level. To read more about brine tanks and where to buy salt, refer to our "Frequently Asked Questions" on page 17. If any red rust stains are apparent, mix iron control agents (Super Iron Out®) with the salt or potassium permanganate.

25

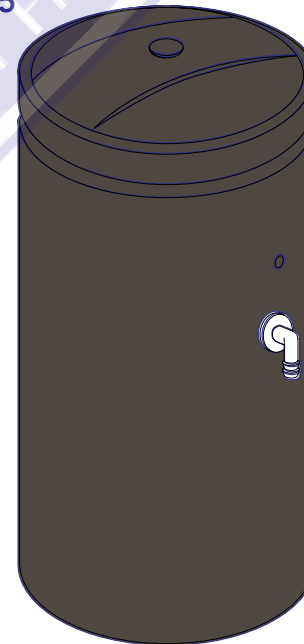

TRANSFORMER

OUTLET

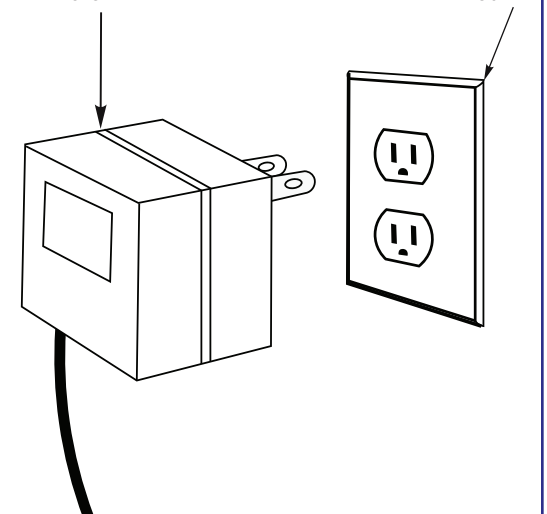



! HOW TO AVOID ACCIDENTAL PROPERTY DAMAGE

Crystal Quest Point-of-Entry Water Filters use the latest technologies available to ensure and prevent water rupture. However, if manufacturing guidelines are not followed, water damage can occur. Causes of flooding include excessive water pressure, spikes in water pressure, human tampering, and negligent installation.

To eliminate possible water and property damage, use the following preventative steps and devices:

1. A licensed plumber should install this unit, reading and following the Installation and Operation Guide as well as all notices.
2. Install a water pressure regulator/control valve inline to keep the water inflow pressure at 60 psi or less.
3. Keep the water supply line from the extreme heat or freezing. Temperature at unit location should be maintained between 35° F and 120° F.
4. Install an inline flood prevention valve/leak control (available at CrystalQuest.com) – instructions at right.
5. In addition to having all other safety devices, use a ball valve to bypass the inflow of water to the system during vacation.

INSTALLING A LEAK DETECTOR VALVE

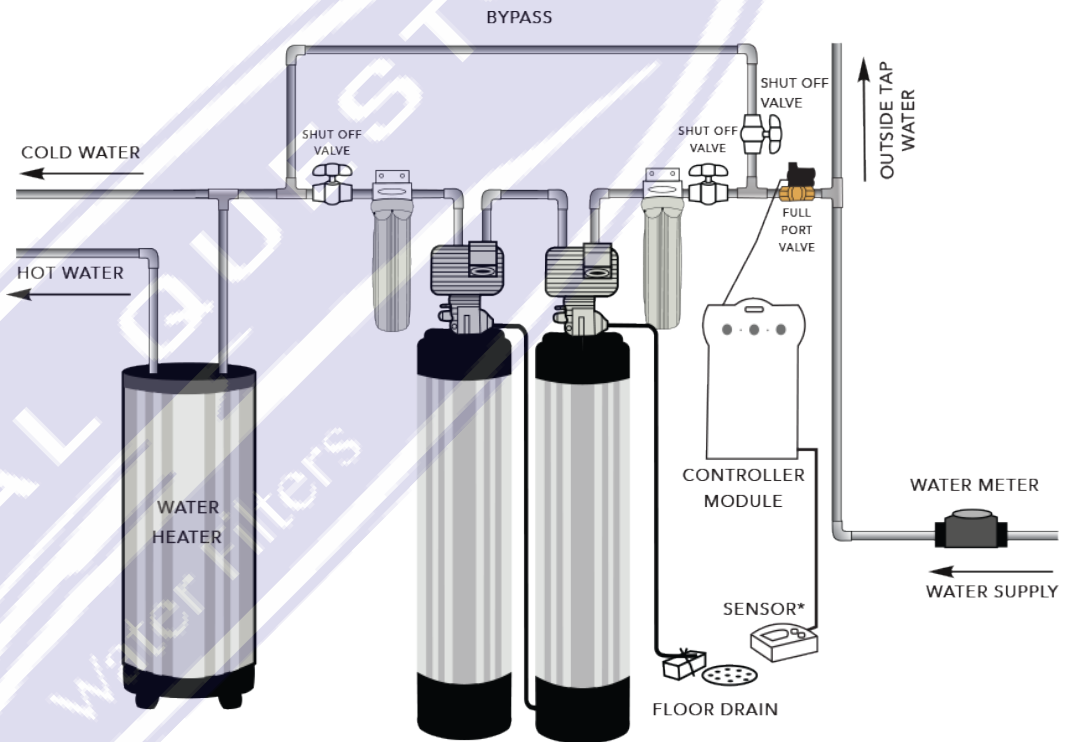

Leak Controllers are specialized water alarm and shut-off systems that use sensors to detect a water leak. The sensor sounds an alarm and then shuts off your water. The alarm continues to sound until the valve is manually reset. By preventing continuous water flow, mold and property damage are restricted.

Features

- 1" full port ball valve with auto shut-off
- Programmable service reminder indicator
- Water detection sensitivity down to 2ppm TDS (total dissolved solids)
- 4 AA alkaline batteries
- Automatic daily valve management
- Available port sizes (inlet/outlet) 3/4", 1", 1-1/4" and 1-1/2"

1. Install leak detector valve into an inlet water line.
2. Move sensor as close to filter as possible. Upon sensing moisture, controller will engage the shut-off valve and sound an alarm.
3. Secure controller module to the wall.



GUIDE FOR REPLACING MEDIA

Media should be changed depending on influent water conditions and consumption.

On average:

- 6-8 years for 2.0 cu. ft
- 5-7 years for 1.5 cu. ft

1. Turn off the water to the unit and unplug from the power source.
2. Disconnect the unit from your plumbing.
3. Carefully unscrew the control valve off the top of the tank.
4. Remove the riser tube from inside the mineral tank.
5. Lay the tank on its side or lay over a trash can to remove media.
6. Rinse the inside of the tank clean with a garden hose, discard old resin, and save the old gravel.
7. Stand media tank upright. Plug a slip cap or put a piece of tape over the top of the distributor/riser tube to prevent media from entering the tube while loading the media.
8. Place the media funnel in the top of the media tank with the riser tube still inside and centered.
9. Begin replacing media by putting gravel into the tank first. Make sure the riser tube is firmly on the bottom of the tank. If the riser tube is pulled out of the gravel once the media is added, it is impossible to put it back in without removing the other media from the tank.
10. Pour resin/media into the funnel, slowly letting it fall down inside the media tank around the riser tube. If you have a twin alternating system, divide the resin/media equally between the two tanks. The media tank should be approximately 3/4 full. The media tank should be approximately 3/4 full but this can vary based on the media for your specific system.
11. Remove the funnel and the slip plug or tape from the top of the riser tube.
12. Brush any loose resin/media off the top opening of the tank. Clean the top edge with a cloth so the O-ring can seal securely to the valve base. Lubricate o-ring with clean food grade silicon grease.
13. Look at the bottom of your control valve and locate the upper basket. Inside the basket, the control valve has O-rings that will seal on the riser tube. Install the valve on top of the media tank, making sure the top of the riser tube inserts inside the opening of the upper basket. Guide the riser into the O-ring seal and tighten gently. Be careful not to over-torque the valve as the threads are plastic.
14. Screw the control valve back onto the top of the tank. Be sure to hold the control valve where there will be no damage to the valve from the pressure you exert from tightening the valve back onto the tank.
15. Reconnect your plumbing to your unit and plug the control valve back in, making sure to set the correct time of day. Turn on the water to the unit and check for leaks.
16. Leave all faucets turned off inside the house, and open a single faucet (such as an outside faucet), letting the water run for 3-5 minutes. This rinses the new resin/media inside the tank, and any particles or color will rinse out through the one open faucet, and not throughout your home plumbing system.
17. Manually turn your regeneration/backwash control knob slowly through a complete cycle, allowing the water to run through the unit for a minute or so in each position.
18. Once the regeneration/backwash knob is back in the service position, your unit is in service and ready to operate!

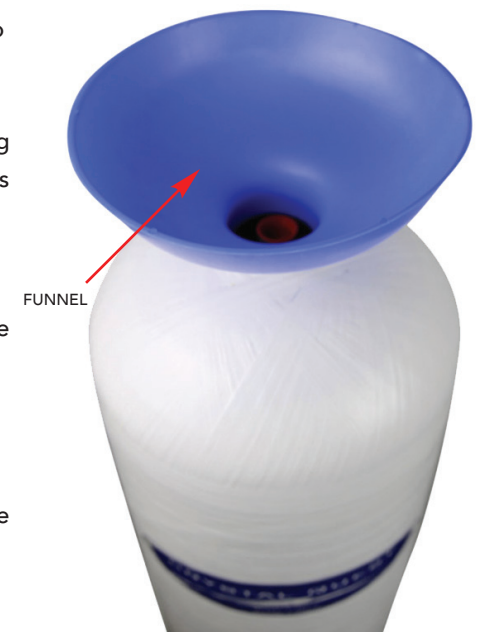



REPLACING FILTER CARTRIDGE AND MAINTENANCE

- You should change your filter cartridge when the water flow is noticeably reduced and/or between 12-18 months.
- Turn off water to filter. Water must be shut off from an upstream valve or bypass.
- Unscrew the filter sump and discard used cartridge.
- Wash the filter sump with mild soap and water. Do not use harsh cleaners or hot water.
- Inspect the filter sump O-ring. Make sure it is lightly lubricated with clean food grade silicone grease. Be sure the O-ring is seated in the groove.
- It is recommended that you replace the O-ring as needed or if it becomes damaged.
- Place a new filter cartridge into the sump, making sure it is centered and completely seated on the bottom seal.
- Reinstall the filter sump to the unit. Use the sump wrench to tighten the sump. **DO NOT OVERTIGHTEN.**
- Slowly turn on water to the filter by using the upstream shut-off valve or bypass.
- After installation, flush the cartridge for 10 minutes, wait one hour, and then flush again for 10 minutes before using the water.

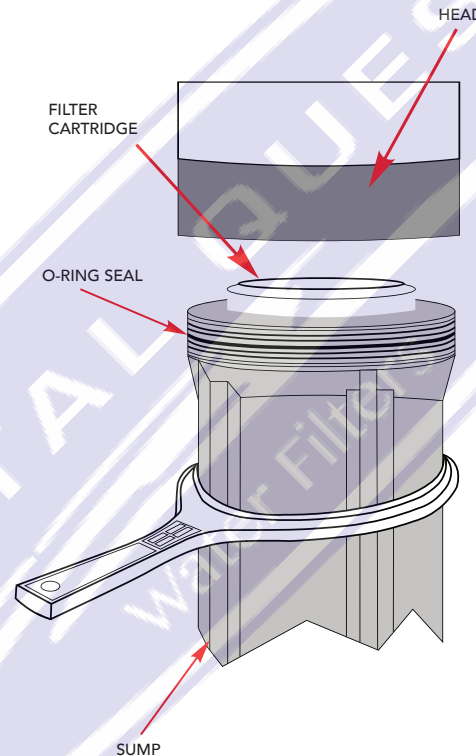

MAINTENANCE

- Periodically check time setting. Power outages will cause time of day setting to become incorrect. To reset, refer to "Programming Automatic Control Valve."
- Should your family size, your water usage habits or your water quality change, the regeneration/backwashing program setting may have to be adjusted. Do not lower salt setting.

MAINTENANCE FOR WATER SOFTENERS

Water softeners work using a process called ion exchange. Your water softener replaces harmful calcium and magnesium ions with neutral sodium chloride/potassium chloride ions. The mineral exchange takes place in one tank as water passes over plastic beads coated with sodium chloride/potassium chloride ions. A second tank (called a brine tank) replenishes the sodium chloride/potassium chloride as it is used up during the mineral exchange process. Here's how to keep your water softener in top shape:

- Inspect the sodium chloride / potassium chloride level in the brine tank at least once a month. If your water softener has recently been installed, check more frequently until you can gauge how much sodium chloride / potassium chloride your unit will require. Fill tank about $\frac{3}{4}$ full. Do not pack full. Do not use block salt or block potassium chloride.
- Sodium chloride / potassium chloride in your water softener's brine tank can form solid cakes that inhibit the proper operation of the unit. As you inspect your brine tank, look for large clumps of solidified sodium chloride/potassium chloride. As a temporary measure, caked salt can be broken up with a broom handle or other long, solid object. Bridged salt will bridge again at a much faster rate and should be removed as soon as possible.
- If iron is present in the water supply, the softener will eventually become iron fouled, resulting in reduced softening capacity and rust stained fixtures. Mixing one or two ounces of Super Iron Out® or similar resin bed cleaner with every 80 lbs. of sodium chloride / potassium chloride added to the brine compartment will minimize these problems.
- Periodically check time setting. Power outages will cause timer/meter setting to become incorrect. To reset, refer to "Setting the Control Valve".
- Once a year, your brine tank should be drained, emptied and cleaned with soap and water. The tank should be rinsed well and refilled.
- Should your family size, your water usage habits or your water quality change, the regeneration program setting may have to be adjusted. Do not lower salt setting.



TROUBLESHOOTING			
PROBLEM		CORRECTION	WATER FILTER SYSTEM
No water flow	✓	<ul style="list-style-type: none"> • Re-read the instructions to install the system properly. • Check the in and out arrows on the bypass valve to ensure the system is not piped backwards. • Make sure the bypass valve is in the "Service" position. 	Mechanical, Automatic, Water Softener or Nitrate and Tannin Filter Systems
Media discharging during backwash/regeneration	✓	<ul style="list-style-type: none"> • Make sure top distributor has been installed properly. 	Mechanical, Automatic, Water Softener or Nitrate and Tannin Filter Systems
System does not backwash/regenerate properly or regularly	✓	<ul style="list-style-type: none"> • Control valve not programmed properly. Check programming and re-program as needed. • Check the well float in the brine tank. The well float should be able to move up and down, and the hose should be able to inject water into the tank and siphon it out again. 	Water Softener or Nitrate and Tannin Filter Systems
Poor performance (filtration/softening ability)	✓	<ul style="list-style-type: none"> • Check the resin media level in the tank. System should be 2/3 full. • Check sodium chloride / potassium chloride level in brine tank. This should be 3/4 full. • Check the frequency and period of backwashing. 	Mechanical, Automatic, Water Softener or Nitrate and Tannin Filter Systems
System uses too much sodium chloride/potassium chloride and excessive water in brine tank	✓	<ul style="list-style-type: none"> • Brine draw not functioning. Clean injectors. Check and reset sodium chloride / potassium chloride settings. 	Water Softener or Nitrate and Tannin Filter Systems
Softener fails to regenerate	✓	<ul style="list-style-type: none"> • Electricity to system has been interrupted. • Check the power source and programming of control valve. 	Water Softener or Nitrate and Tannin Filter Systems
Iron build up in water conditioner and loss of water pressure	✓	<ul style="list-style-type: none"> • Clean control and add resin cleaner. Increase regeneration frequently. • Check the pre- and post-filters for timely replacement. 	Water Softener or Nitrate and Tannin Filter Systems
Injector or injector screen plugged	✓	<ul style="list-style-type: none"> • Clean control and add resin cleaner. Increase regeneration frequently. 	Water Softener or Nitrate and Tannin Filter Systems
Leak in distributor tube	✓	<ul style="list-style-type: none"> • Put the system in bypass position and depressurize* the unit by putting into "Backwash" position. There are two screws on neck of valve where the salt rinse line goes into softener. Remove the two screws and clean screen to remove any chunks of salt, etc. 	Water Softener or Nitrate and Tannin Filter Systems

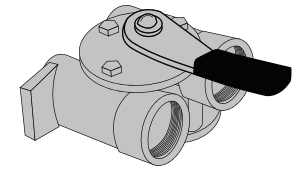

After prolonged periods of non-use (such as during a vacation), it is recommended that the system be flushed thoroughly.

1. First put the system in bypass by turning the bypass valve to the "BYPASS" position.
2. Let water run for 10-20 minutes by opening all faucets to flush the pre- and post-filters and all water supply lines.
3. Turn handle on bypass valve to "SERVICE" position to backwash* the system.

*To backwash or depressurize the system, refer to "Programming Automatic Control Valve" in manual.



? FREQUENTLY ASKED QUESTIONS

What is shocking a well, is it necessary, and how do I do it?

- 'Shocking a well' refers to disinfection by means of chlorine to rid bacteria and other contaminants from a well. It is definitely suggested if there is iron or sulfur in the well, if it a newly constructed well or an old well that hasn't been disinfected in a while. There are 3 techniques that can be used to shock a well depending on your preference.
- Chlorination Techniques for Well Water:
 - 1) Shocking a well with bleach: This is the cheapest and quickest way to shock a well. For shallow wells (40 ft. or less) add a ½ gallon of bleach. For deep wells (40 ft. and over) add a gallon of bleach.
 - 2) Using chlorination tablets: Similar to adding bleach, only specifically made to put into wells. Sold through Crystal Quest®. Please call 1-800-934-0051.
 - 3) Chlorine Injection Systems: A separate device to be tied straight into the line and set to automatically pump a certain amount of chlorine into the water each day. Sold through Crystal Quest®. Please call 1-800-934-0051.

When is the ideal time to change the pre- and post- filters?

- Between 12-18 months. Please visit CrystalQuest.com for replacement cartridges.

What salt is used in the brine tank, where do I buy it, and how much of it will be used?

- Sodium chloride or potassium chloride, which can be bought at your local hardware store. Because of the high costs associated with shipping these solutions, it is best to buy locally.
- The brine tank should be filled up about ½ to ¾ of the way with the salt and topped off with water (just above the salt level). The user should attempt to maintain the level of solution around the halfway point in the brine tank. It will slowly decrease over time. When it reaches around 1/3 or ¼ of the original salt level, add more to the halfway point.

Will my whole house system affect water pressure?

- As long as the appropriate sized system was installed for the house-size and water demand, there should be very little change, or none at all. If you think you may have purchased the wrong sized system, please contact us at 1-800-934-0051.

How do I reset an automatic head?

- Refer to page 8 in the manual and re-do steps under "Programming Automatic Control Valve".

How often do you need to backwash a manual system?

- Generally, once a week for 10 minutes. In some conditions, it can be adjusted based on influent water (i.e. high iron content needs to be backwashed more frequently)

How can you do a manual backwash with an automatic head?

- 1) Press the Regeneration button and hold until it says 'BW'
- 2) It will automatically begin a 10 minute backwash

Can I change my valve head?

- A new valve head can always be purchased if you find yourself wanting a different functioning head. Please call us 1-800-934-0051.



? FREQUENTLY ASKED QUESTIONS CONT.

I'm having issues with my media working properly, what should I do?

• The answer most likely is too high of water pressure, resulting in ineffective media because there is not enough contact time. The prime fix is to slow down incoming water by installing a pressure regulator which allows the water more contact time with the media, thus allowing the media to do its job more effectively. The same fix is for customers with very high native pressure that need to bring it down to a constant 50-60 psi (recommended) in order to use our systems. Pressure Regulators are available in 1" & ¾" for purchase through Crystal Quest®. Please call 1-800-934-0051 to order. If water pressure is not the issue and your media is failing due to old age (older than 5-10 years and/or depending on influent water conditions and consumption), please visit CrystalQuest.com or call to buy new replacement media.

What do some of the pop-up acronyms mean on my automatic valve head?

- **[Parameter Display - Data Display]** Brief explanation of what the setting controls and recommendations for correctly setting it.
- **[Parameter Display - ****]** A setting that should not be shown if setup correctly. If you are seeing this setting check to ensure other settings are set correctly.
- **[TD - 11:08]** Time of Day, tells the system what the current time is. To change the time, press and hold the up OR down arrow until the service icon is replaced with the programming icon. Use the up and down arrows to set the time of day (PM is indicated in the upper right corner of the screen). Once the time is set, press the extra cycle button or don't press anything for 5-10 seconds to return to normal operation.
- **[DO - 7]** Day Override, this setting will cause the system to backwash after the set number of days. Typically set no higher than 3 to ensure the media gets lifted and cleaned off.
- **[RT - 2:00]** Regen Time, this is the time of day the system will backwash. This process typically takes 30 minutes - 2 hours depending on system size, so schedule it when water will not be used. It is common to set to run when everyone is asleep, and ensure it does not conflict with any other systems you may have.
- **[DF - GAL]** Display format, shown settings is gallons. Liters [Ltr] and Cubic Meters [Cu] are alternative settings, however, all instructions are written on the basis of the [Gal] display format.
- **[VT - dF1b]** Valve type, set to the downflow single backwash setting shown.
- **[CT - tc]** Control Type, sets the operation of the controller. Backwashing systems use the time clock [tc] setting where backwash is based on time (days) passed.
- **[NT --- 1]** Number of tanks holding media for treatment.
- **[BW - 10]** Backwash, the length of time used for the backwash part of the cycle, actual setting varies depending on system size.
- **[BD-60]** Brine Draw for 60 minutes. This means that salt will be pulled from the brine tank to the system to regenerate. Regenerating with brine draw backwashes the media and puts water back into the brine tank.

If you still did not find your solution here, please contact our Service Department at service@crystalquest.com or 1-800-934-0051.

For any specific chemistry related questions about your water and/or the media used, please call one of our water specialists at 1-800-934-0051.



ONE-YEAR LIMITED WARRANTY

CRYSTAL QUEST® warrants your CRYSTAL QUEST® Point of Entry Whole House Water Filter System* for one year from the date of purchase against all defects in materials and workmanship when used in compliance with the manual. This warranty does not include replacement cartridges unless defective upon receipt. CRYSTAL QUEST® disclaims all implied warranties including, without limitation, warranties of merchantability and fitness for a particular purpose. If for any reason the product proves to be defective within one year from the date of purchase, please call for assistance. This warranty gives you specific legal rights and you may have other legal rights which vary from state to state. CRYSTAL QUEST® assumes no responsibility for incidental or consequential damages, for damages arising out of misuse of the product, or the use of any unauthorized attachment. Some states do not allow the exclusion or limitation of implied warranties or incidental or consequential damages; therefore, the above limitations or exclusions may not apply to you. Should service be required during or after the warranty period or should you have any questions regarding how to use your CRYSTAL QUEST® Point of Entry Whole House Water Filter System, please contact our Technical Support Department at service@crystalquest.com, Monday through Friday, 9 AM to 5 PM Eastern Time.

*Warranty varies on components of the whole house water filter system. Contact your Crystal Quest® Dealer or Email support@crystalquest.com for more information.

ORDERING REPLACEMENT CARTRIDGES

- | | |
|--|--|
| 2-7/8" x 20"
Carbon Block Filter Cartridge
12-18 months lifetime expectancy | COE-RC-04014

7 85 08 40 40 14 1 |
| 2-7/8" x 20" Sediment Reusable
Pleated Filter Cartridge
12-18 months lifetime expectancy | COE-RC-04015

7 85 08 40 40 15 8 |
| 2-7/8" x 20"
UF Membrane Filter Cartridge
18-36 months lifetime expectancy | COE-RC-04056

7 85 08 40 40 56 1 |
| <i>(Optional cartridges for use with Compact Whole House Systems. Refer to Compact Whole House Installation and Operation Guide for more details.)</i> | |
| 2-7/8" x 20"
SMART Filter Cartridge
12-18 months lifetime expectancy | COE-RC-04016

7 85 08 40 40 16 5 |
| 2-7/8" x 20"
Fluoride Filter Cartridge
12-18 months lifetime expectancy | COE-RC-04019

7 85 01 40 40 19 7 |
| 2-7/8" x 20"
Nitrate Filter Cartridge
12-18 months lifetime expectancy | COE-RC-04020

7 85 08 40 40 20 2 |
| 2-7/8" x 20"
Arsenic Filter Cartridge
12-18 months lifetime expectancy | COE-RC-04021

7 85 08 40 40 21 9 |

To order replacement cartridges or replacement media, contact your Crystal Quest® Dealer or visit us online at crystalquest.com

YOUR PURCHASE INFORMATION

Please record the information below for your future reference

PLUMBER'S NAME	PLUMBER'S ADDRESS	PLUMBER'S PHONE

KEEP THIS MANUAL FOR FUTURE REFERENCE AND UNIT MAINTENANCE

Online warranty information
<http://crystalquest.com/warranty.htm>

Product design is subject to change without notice.

For further assistance, contact your Crystal Quest dealer or visit us at www.crystalquest.com

To view the latest edition of the Point of Entry Whole House Water Filter System, visit CrystalQuest.com

Please note all drawings, pictures, colors and sizes are approximate for illustrative purposes only and may not exactly resemble the end product.