

NESTOR MARTIN

WOODBBOX® TECHNOLOGY

S - H



INSTALLATION, USE AND MAINTENANCE INSTRUCTIONS.

INSTRUCCIONES PARA INSTALACIÓN, USO Y MANTENIMIENTO



ABOUT THESE INSTRUCTIONS

These instructions cover the Nestor Martin range of Harmony (H) and Stanford (S) Woodbox® stoves and the TruHybrid variant.

It offers installation and operation information for the range of HARMONY H13, H23, H33, H43. STANFORD S13, S23, S33. In some cases you find references in this document to the model size rather than the models exterior design. There are four sizes of appliances, 13, 23, 33, 43. The 13 is the smallest and the 43 the largest. Although the exterior castings change between model ranges, for example the Harmony 23 and the Stanford 23, the internal workings are the same.

TruHybrid Woodbox® stoves

Increase the efficiency of your stove while taking care of the environment. In addition to the reduction of fuel consumption, thanks to this new system the emissions that occur during combustion are also significantly reduced.

It is only recommended that dry seasoned wood with a moisture content of 20% or below be used in the TruHybrid stoves.

The burning of smokeless coal is not recommended as this can reduce the life of the catalyst used in the TruHybrid system.

For full instructions for the TruHybrid stoves please refer to the instructions specific for this variant supplied with the stove.

Model Identification

There is a stove identification plate fitted to the stove giving the details of each appliance.

This can be found in a number of places on the stove depending upon the model and date of manufacture:

1. On a plate that swings out from under the ash pan housing.
2. On a plate that swings out from the left hand side of the rear heat shield.
3. A label fitted on the rear of the stove towards the bottom of the rear heat shield.

WARNINGS

Due to the high operating temperatures of this appliance it should be located away from pedestrian traffic and away from furniture and draperies. Mats and rugs put in front of the stove should be fire proof and secured to prevent the possibility of tripping.

Do not store paper or wood near the appliance. Do not store or use petrol or other flammable vapours and liquids in the vicinity of this or any other heating appliance. Do not use aerosol sprays near the stove when the stove is alight. Do not burn anything but natural wood or approved smokeless coals on this appliance.

Advise all persons as to the stove's high surface temperatures. If it is possible for children or infirm adults to come into contact with the stove, fit a suitable fire guard.

It is imperative that all air passageways into, out of, and within the appliance are kept clean. All permanent ventilation into the room provided for the stove must remain clear and unobstructed at all times. Consideration must be given to the need for extra ventilation if another heating source needing air is to be operated simultaneously. If an extraction fan is proposed to be fitted to a connecting area of the house, after the stove has been installed, professional advice should be sought from a qualified engineer.

The user should be advised that the appliance should be inspected regularly and the chimney cleaned at least annually. More frequent cleaning may be required and the advice of a qualified chimney sweep should be sought.

Your attention is drawn to the precautions and responsibilities under the Health and Safety at Work Acts, and whatever new legislation being introduced during the life of this document. Especially to the possibility of disturbing asbestos when disturbing structures in older properties. Also the caustic nature of fire cement. The personal risk of injury when moving heavy items with possible sharp edges.

Improper adjustment, alteration, maintenance or the fitting of replacement parts not recommended by the manufacturer can cause injury or property damage.

Do not operate the stove with faulty seals or damaged glass.



1. INTRODUCTION

IMPORTANT! All local regulations, including those that refer to national or European regulations, must be applied when installing this device.

The way the stove is installed will decisively affect safety issues and its correct operation.

It is important to install the stove correctly. For the correct installation of the stove and chimney, we recommend the installation be performed by a professional.

Please read this entire manual before you install and use your new room heater. Failure to follow instructions may result in property damage or bodily injury.

2. INSTALLATION

If your stove is not properly installed, injury or property damage may result. For your safety, follow the installation directions. Contact local building or fire officials about restrictions and installation requirements in your area.

Warning: Do not connect this unit to a chimney flue serving another appliance. The unit must be installed according to all local codes. Installations other than those specifically covered herein have not been confirmed by test and are not covered by the certification.

2.1. Chimney.

The chimney is a vital part of your stove installation. A properly built masonry chimney will assure a consistent draft under a variety of weather conditions. (A smoking stove is almost always caused by a chimney problem). All chimneys must be installed either according to the local building codes in the case of a masonry chimney or according to the chimney manufacturer's instructions in the case of a factory-built metal chimney. See the chimney manufacturers' instructions for exact specifications. Existing chimneys must be inspected before installing your stove. Consult your local building department for chimney code requirements. A masonry chimney should have a code approved liner. This liner must not have broken or missing pieces. Some non-code masonry chimneys may be brought up to code by being relined. (Consult your dealer or qualified chimney sweep.)

Factory-built metal chimneys should also be inspected, first for creosote deposits (which should be removed), and then for integrity of the stainless steel liner. Look for obvious bulges in the lining which may indicate the need to replace that section (use a bright flashlight). Also inspect the attic to see that the chimney has proper clearance to combustible framing members. The chimney or vent shall be designed and manufactured to develop a flow sufficient to completely remove all flue and vent gases to the outside atmosphere. The venting system shall satisfy the draft requirements of the connected appliance in accordance with the manufacturer's instructions. The location, section and height of the chimney affect the draft.

2.1.1. Chimney height requirements.

We recommend that the chimney be:

1. at least 100 cm higher than the highest part of the roof opening through which it passes,
2. and at least 60 cm higher than any part of the roof within 300cm, measured horizontally.

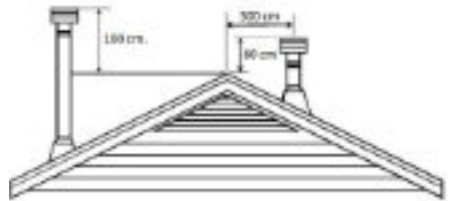

2.1.2. Draft requirements

The appliance is merely one component of a larger system. The other equally important component is the chimney. This is necessary for achieving the required flow for safety removing unwanted combustion by-products from the appliance. If the chimney design does not promote these ends, the system may not function properly.

The recommended draft requirements for your stove is no less than -15 pa ($-0.048''$) and no greater than -25 pa ($-0.12''$).

OPERATION OF YOUR STOVE WITH A DRAFT GREATER THAN -30 Pa ($-0.14''$) CAN POSSIBLY CAUSE DAMAGE TO THE STOVE AND VOID THE WARRANTY.



2.1.3. Summary of rules

We shall now provide a summary of the rules that should be followed when building a chimney:

Use resistant and non-combustible materials for the connection between the appliance and the chimney, which are protected if possible against rust (enamelled steel, stainless steel, ...)

Choose the most vertical route possible.

Do not connect several devices to the same chimney.

The conduit should not come to an end near buildings and must be higher than the nearest obstacle if there is another building nearby.

The internal walls must be perfectly smooth and free from obstacles.

Avoid bottlenecks where pipes join the brick chimney.

Ensure that the joints of the pipes are well sealed to avoid air entering through cracks.

We recommend that enamelled stoves are installed with the rear flue exit option.

2.2. Installation of the stove.

1. Position the unit no closer than the minimum clearances to combustible materials (see safety chapter). Reposition unit if necessary, being careful not to move closer than the minimum clearances.

2. Position the unit on the floor at the proper clearances. If the floor is made of combustible material (for example, parquet) it must be protected with a slab of fireproof material, placed under the stove and around it. The size should be such that it protrudes from the appliance: 20cm back and sides and 50cm front.

3. Install the stove to the fireplace, sealing it properly.

4. The stove's flue can never be connected to air ducts or a ventilation system.

5. Appropriate firebreaks/firewalls must be installed when a section of the chimney passes through floors and/or ceilings. The insulation will be at least 50mm thick from the flue to the structure. It is necessary to protect the walls with wall protectors when the chimney is not at the indicated safe distance and damage may occur. (See Fig. 2.)

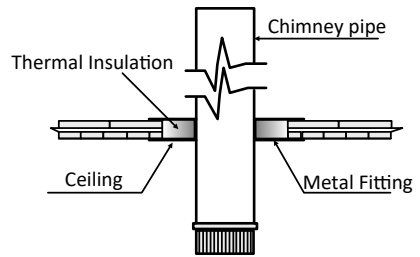

Fig.2

DO NOT CONNECT THIS UNIT TO A CHIMNEY FLUE SERVING ANOTHER APPLIANCE.

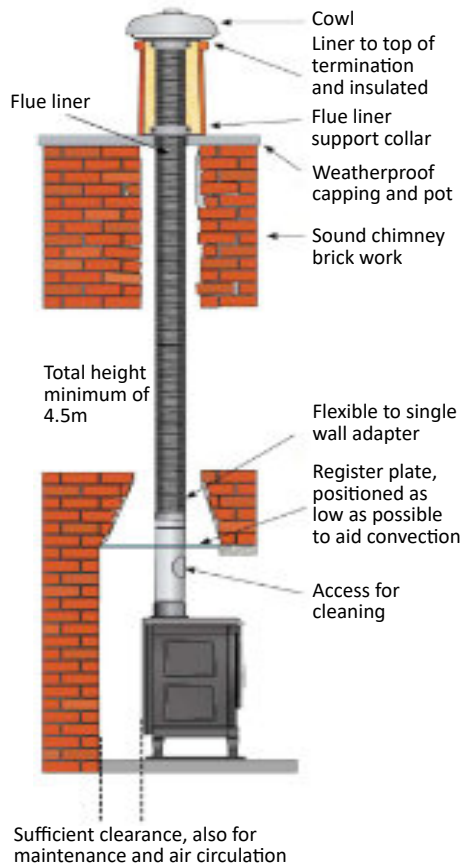

Fig. 3.- Chimney connection in a fireplace

2.3. Above a Fireplace.

In this type of installation, the chimney connector rises from the stove, turns no greater than 45°, and then goes into the fireplace chimney. The liner of the fireplace chimney should extend at least to the point at which the chimney connector enters the chimney. Follow all the guidelines for installing a chimney connector into a freestanding masonry chimney, and pay special attention to these additional points:

Double check the connector clearance from the ceiling: 18" (45 cm) minimum.

The fireplace damper or register plate must be closed and sealed to prevent room air from being drawn up the flue, thereby reducing the draft.

However, it must be possible to re-open the damper or have an access plate in a register plate to inspect the chimney.

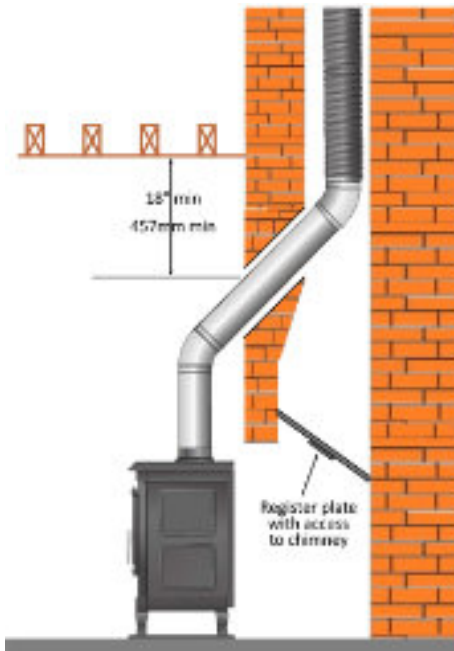

Fig. 4. – Chimney connector enters chimney above the fireplace

2.4. Wall Pass-Throughs

Whenever possible, design your installation so that the wall connector does not pass through a combustible wall. If you are considering a wall pass-through in your installation, check with your building inspector before you begin. Also check with the chimney connector manufacturer for any specific requirements.

Accessories are available for use as wall pass-throughs.

If using one of these, make sure it has been tested and listed for use as a wall pass-through. We recommend the following guidelines when passing chimney connectors through combustible walls:

- Cut away all combustible material in the wall a sufficient distance from the single wall connector, to provide the required 12" (300 mm) clearance for the connector. Any material used to close the opening must be non-combustible (as in Fig. 5 below).
- Using a section of double-wall chimney with a 9" (230 mm) clearance to combustibles.
- Placing a chimney connector pipe inside a ventilated sleeve, which is then separated from combustibles by 6" (150 mm) of fiberglass insulating material.

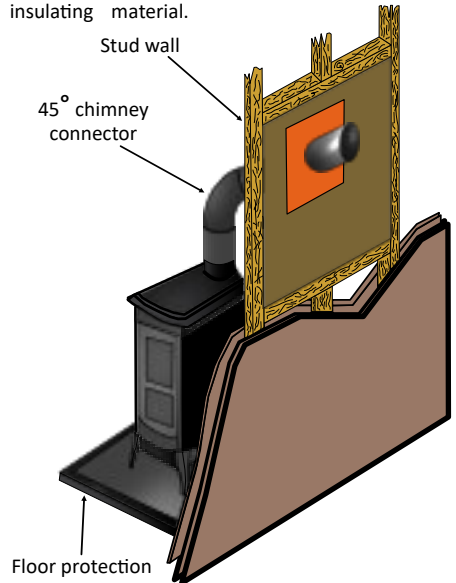

Fig. 5. – An example of a correct Wall pass-through.

3. USE

Once your stove has been installed and connected to the chimney, you are ready to light the fire. Before lighting your stove for the first time, please take time to become familiar with the different control systems and parts of the unit, how to choose the wood, how to light it and use it on a daily basis.

Ensure that the ash pan is empty.

ALWAYS KEEP IN MIND that the stove generates heat and, therefore, keep children, clothing, furniture... at a distance to prevent burns from direct contact with the appliance.

Below, we have included some advice on your stove and on its use. Please read with care.

3.1. THE WOODBOX® COMBUSTION

Diagrammatic view of a Woodbox® stove (without the TruHybrid components fitted).

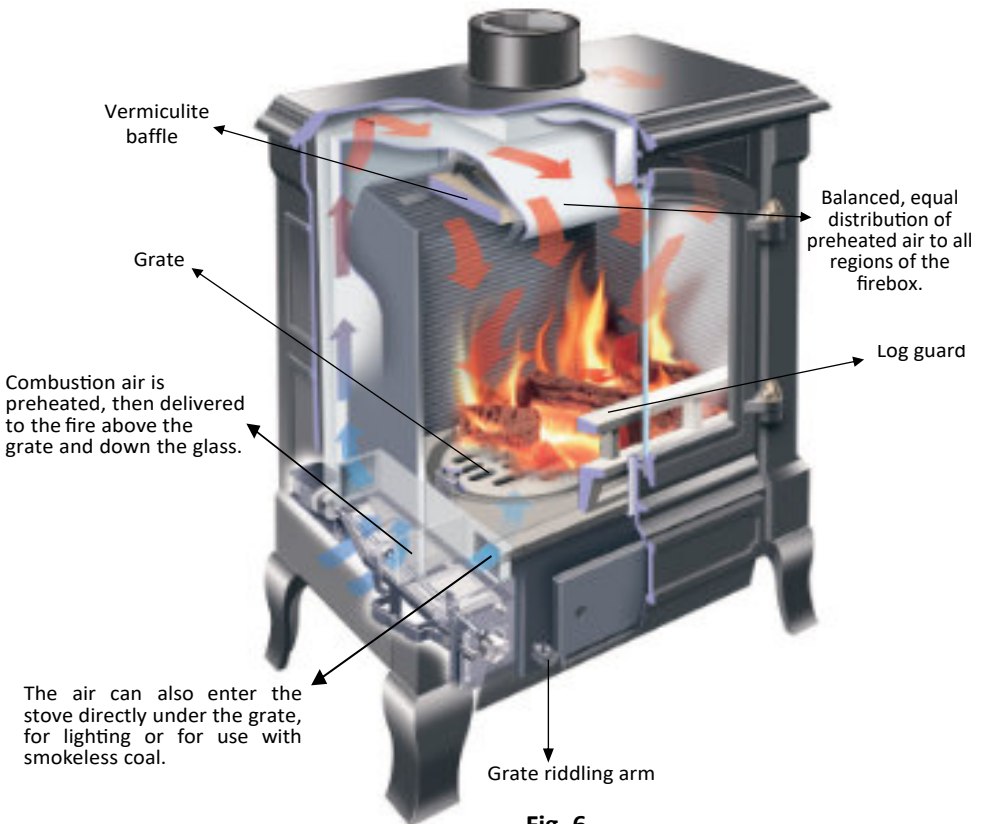

SYSTEM

The Woodbox® system uses a balance of preheated primary air, secondary air and natural flue draft in a process of combustion and post-combustion, to obtain extremely high efficiency and total controllability of the fire.

The Woodbox® stoves, are equipped with a variable flap mechanism to control the air intake with precision, according to the type of combustion and the desired tempo of the fire. The controls allow you to open these flaps manually or an optional remote control kit allows you to open and close these flaps automatically. Using the automatic mode means once the room temperature has been reached the stove will reduce its burn rate so saving you wood and therefore money.

Fig. 6

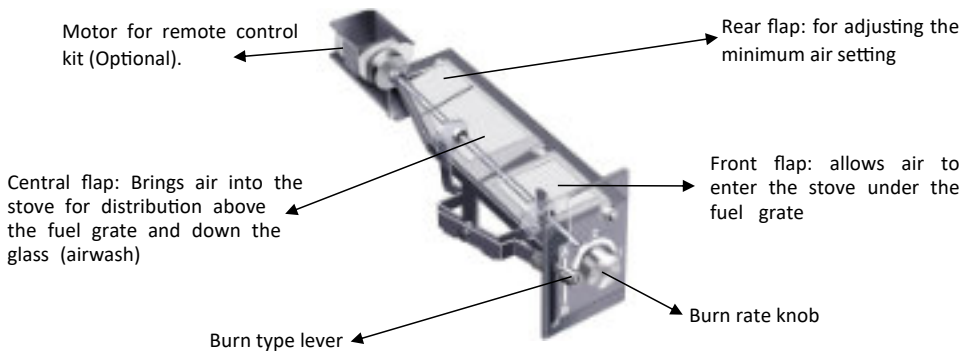

Fig. 7

3.2. THE TRUHYBRID SYSTEM

If your stove also includes the new TruHybrid System, it will increase the efficiency of your stove while taking care of the environment. In addition to the reduction of fuel consumption, thanks to this new system the emissions that occur during combustion are significantly reduced.

This is achieved by the catalytic system installed in the upper part of the combustion chamber. Closing the bypass, once the combustion chamber has increased its temperature, will allow the gases to recirculate through the catalyst, where a chemical reaction will occur, in which the vast majority of the emissions generated during the combustion process will disappear.

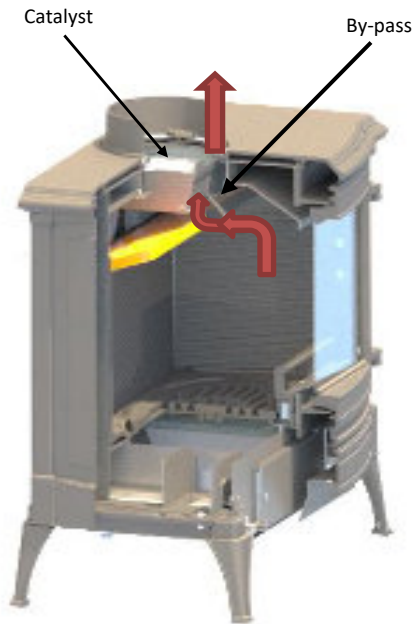

Fig. 8 By-pass close

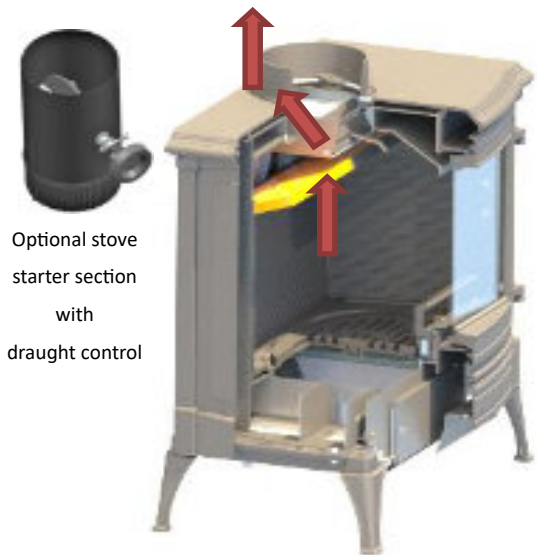

Fig. 9. By-pass open

3.3. USING THE AIR CONTROL.

Your stove will have one of these control panels, allowing you to adjust both the volume, by rotating the round knob, and the direction from which air enters the stove, by moving the lever vertically up or down.

Always use the tool supplied with the stove when adjusting the controls.



S/H 13 MODELS

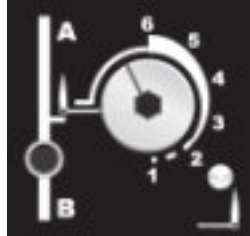

S/H 23 MODELS

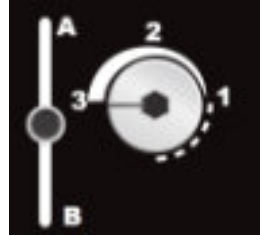

S/H 33-43 MODELS

Burn rate knob: Governs the amount of air entering the stove. Allows you to control the tempo of the fire. As the knob is rotated counter-clockwise, the cam progressively opens the air flap to increase the amount of air entering the stove.

Low operation

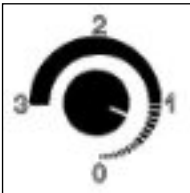

At low setting, the flap is barely open as to reduce the intake of air

Normal operation

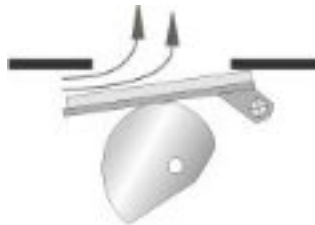
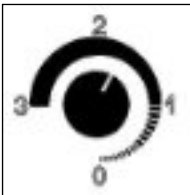

At normal setting, the flap is about half-way open

Lighting

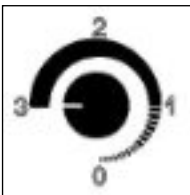

Generally, the maximum open setting "3" or "6" is only used for lighting

Rotation Stop Button

To enable the Air Volume Control knob to be rotated to the lighting position, on certain models, press the rotation stop button inwards then rotate the Air Volume Knob.

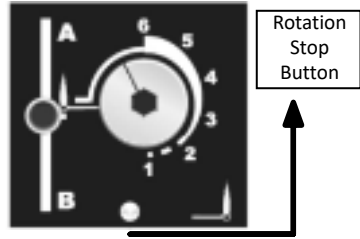

Burn type lever: Controls the direction of the air flow, either above or below the fire bed or a mixture of the two. Adjust according to the fuel type and for lighting and reviving the fire.

Lighting

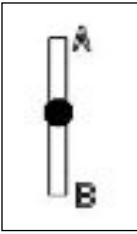

Burn Type Lever in mid position: Providing maximum air above and below grate for ignition

Wood

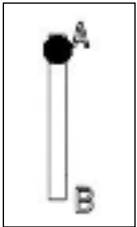

Burn Type Lever raised (position "A"): Providing top air for wood burning

Smokeless Coal

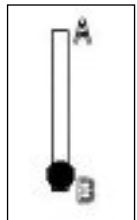

Burn Type Lever lowered (position "B"): Providing bottom air for coal burning

3.3.1. Burn types

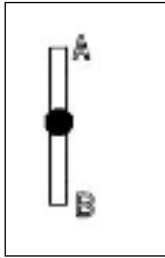

Lighting

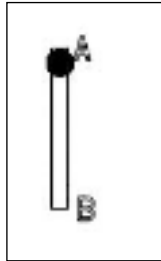

Wood

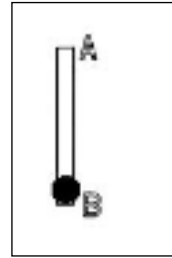

Smokeless Coal

3.3.2. Burn rates

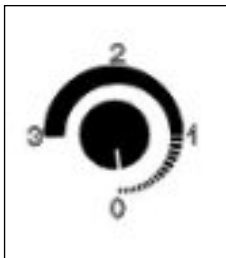

Minimum

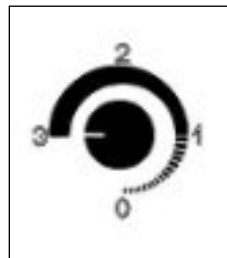

Maximum

On certain models, press the rotation stop button inwards to enable the maximum burn rate to be achieved.

3.3.3. Examples of air settings

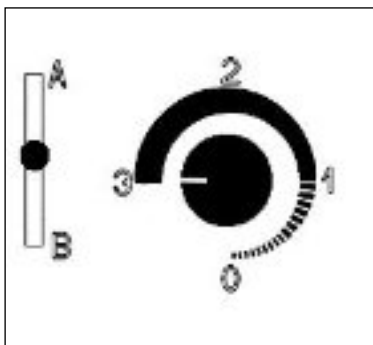

Fig. 11. Lighting and reloading

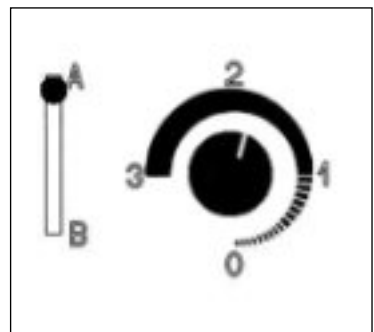

Fig. 12. Normal running, wood.

3.3.4. Minimum air setting

The adjustment knob for the minimum air intake can be found underneath the stove, on the air flap assembly. It is factory set. This knob allows you to increase or decrease the minimum air intake.

Adjust this knob according to your chimney's draught, when the chimney is at its operating temperature and using an accurate flue draught gauge. See section 2.1.1, Chimney height requirements, for the recommended flue draught.



Adjustment knob

Fig. 12

Minimum air screw open
(this is the factory setting, suitable for a
normal flue draught).

Minimum air screw closed or nearly
closed (in the case of an excessively
strong flue draught)



3.3.5. Remote Control (optional)

This stove has the option of remote control.

Fitting the remote control Motor:

At the rear of the appliance you will see the motor fitting bracket. This incorporates a magnet and the mechanism friction plate. The friction plate is hinged. To fit the motor, this friction plate needs to be detached from the magnet and swung to the left. The motor can now be slipped into place. The magnet retains the motor.



Fig. 13

Connect the electrical lead to the receiver box and the receiver box in its holder.

Detailed instructions on the use of the remote control can be found with the remote control kit.



Fig. 14



Fig. 15

3.4. LIGHTING

IMPORTANT! The surface of your device is protected by a coat of special anti-heat paint that resists high temperatures. When lighting the stove for the first few times, the said paint may emit some fumes. This is normal and is due to the evaporation of certain components of the paint while it adapts to the heat. We, therefore, recommend ventilating the room until this phenomenon ceases to appear. It is very important that the first time the heater is lit, it is done so slowly. This is for the following reasons:

- Stabilise cast iron parts.
- Harden the joint sealant putty.

We recommend that the first loads of fuel be small and keep the stove on for a few hours at this intensity. The stove must be closed at all times during combustion to prevent smoke from leaking out. Only open to add fuel.

ATTENTION! During the operation of the stove, the metal parts can reach high temperatures. Protect your hands with fire resistant gloves when touching these parts.

Use the tool provided to operate the stove's air controls, as well as to open the ashpan door.

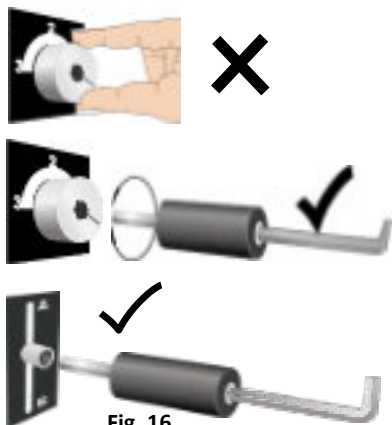

Fig. 16

Steps to light the stove:

1. Be sure the ash drawer is closed and secured. Slide the Burn Type Lever to the centre position (See the setting on fig. 11).

2. Open the Burn Rate Knob all the way by turning to the left. This knob may be turned manually or by pressing "ON/HI" on the remote control (optional). (See the setting on Fig. 11)

If your stove has the TruHybrid System, open the by-pass placed in the top inside the stove (Fig. 17).

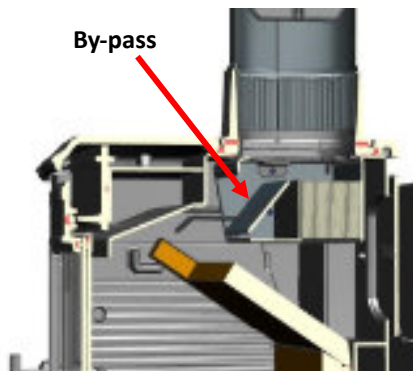

Fig. 17

If you also have an optional draft control, fitted in the flue above the stove, place the valve open (page 7).

3. Place two or three loosely crumpled sheets of newspaper in the bottom of the stove. Add a good amount of dry kindling forming a loose cone formation on the top of the newspaper. Place a few more loosely crumpled sheets on top of the kindling and light the bottom paper first, then light the top paper. The upper fire should preheat the chimney and create an effective draft while the lower fire ignites the kindling. It is advisable to leave the door ajar for a few minutes to facilitate the ignition and avoid condensation, keeping the glass clean. Never leave the stove unattended with the door open.

4. Once the cone has collapsed and the kindling is well charred, add increasingly larger pieces of wood until the fire is actively burning.

5. When the fire is well established, slide the Burn Type Lever to the top for normal operation with wood ("A"). Then adjust the Burn Rate Knob to the desired heat output, either manually or with the remote control. If you have the TruHybrid System, close the by-pass to allow the flue gases pass through the catalyst (Fig. 18) to achieve the maximum efficiency of the stove. Protect your hands for such an operation. In addition, if you have an optional draft control (page 7), you can also regulate combustion by operating this control.

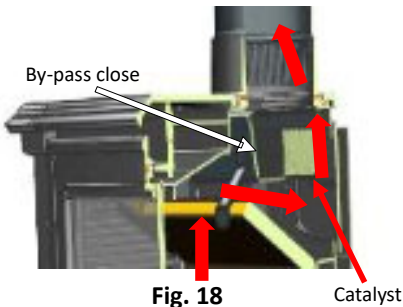

Fig. 18

Catalyst

When burning smokeless coal: **(Not recommended in the TruHybrid stoves)** Always keep the Burn Type Lever in its lower position ("B"), once the fire is established. If your model has a blind grate, remove it, lift the grate from the bottom of the fire chamber. Under the grate is the blind grate.

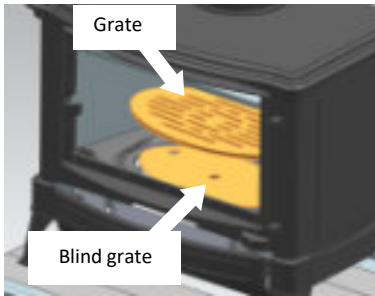

Fig. 19

3.5. RELOADING THE STOVE

To refuel the stove, first slide the Burn Type Lever to its mid position, and then rotate the Burn Rate Knob to maximum. Let the fire "liven up" for about one minute. Always riddle the grate before putting another load of smokeless coal to give the initial release of gasses sufficient air with which to burn. Open the front door slightly and hold in this position about 30 seconds or until stove is drafting well. Open the door all the way and rake the embers towards the front of the stove, spreading them evenly. If there are logs only partially burned, rake these to the front of stove. Add fuel. If the fire or coal bed is almost depleted and a full load of logs or coal is added, it may be necessary to leave the Burn Rate Knob on the high setting for a while to re-establish a lively fire. Once the fuel is burning at a brisk rate, slide the Burn Type Lever back to Position A (wood) or B (coal) and turn the Burn Rate Knob down to the desired setting.

3.6. OVERNIGHT BURNING

The Burn Rate Knob allows you to adjust the size of the intake opening, and therefore the tempo of the fire. Turning the knob to the left increases air intake, resulting in higher flames and a cleaner burn; Turning the knob to the right decreases air intake, thus lowering the flames and prolonging the burn time.

If you fill your appliance with wood and close the air supply, you will produce smoke and tar and the window glass will become dirty. To keep the glass clean and burn overnight without producing smoke we recommend you build up a bed of charcoal, which will burn cleanly for many hours with the air flow reduced to a low setting, the depth of charcoal will depend on the length of time you wish to run it for. Do not shut the air control completely but leave it slightly open, depending on how the chimney draws, to achieve slow burning for a maximum of 8 hours (with dry, good quality wood such as oak...).

With a well drawing chimney, the air control will need to be closed further than with poor drawing chimneys. If your window glass becomes tarred after a low burn, you may burn the tar off by using the integrated air wash system. To do so, turn the Burn Rate Knob to maximum and run the stove hard with a small charge of dry seasoned wood.

3.7. ASH REMOVAL

IMPORTANT! Only handle the ash pan when the stove is cold. Always avoid opening the ash-pan if your stove is in operation. Empty the ash pan regularly to prevent the ash from spilling over. Do not allow ash to build up and touch the under side of the grate. A layer of ash left over the grate when burning wood will protect the grate, retain heat, and promote clean combustion. To clean the ash from the stove, use the poker provided. The grate can also be riddled to encourage ash to fall into the ash pan.

The riddling rod is located between the plexus fascia panel and the ashtray door (Fig. 20).

With the tool provided, you can operate the knob pulling forward and pushing back to shake the grate.





Fig. 20

If your model has a blind grate, remove it from the stove before cleaning the ash (Fig. 19).

To remove the ash pan from the stove, take the provided tool and pull gently from the ash pan. This tool for removal of the ash pan should not be used to carry the ash pan. **Use heatproof gloves holding the ash pan on both sides.**

Place ashes in a metal container with a tight fitting lid. The closed container of ashes should be placed on a non-combustible floor, well away from all combustible materials, pending final disposal. Ashes should be removed from the ash pan when cold.

3.8. FUELS

Recommended solid fuels: anthracite coal 20/30 size, hornbeam, beech wood, oak wood, fruit tree wood, birch wood and smokeless fuel designated to be suitable for use in a closed appliance.

Unsuitable solid fuels: fir wood, moist wood, chemically-treated wood, wood chips, wood pellets, Petroleum coke. Do not burn trash in your appliance. Do not use wood washed ashore from the sea as fuel. The salt contained in it will react in the combustion process and release acid that will damage the iron and steel.

Do not burn particle board scraps or pressed logs using bonding agents because they can produce conditions which will deteriorate metal. Green or uncured wood does not work well as fuel, and can cause increased creosote build-ups. The value of green wood as a source of heat is limited. Do not overload or use kindling wood or mill ends as primary fuel as this may cause over-firing.

Your stove is approved for use with wood, anthracite or smokeless coal only.

Over-firing is a condition where excessive temperatures are reached, beyond the design capabilities of the stove. The damage that occurs from over-firing is not covered under the warranty.

WARNING: Do not use petrol, lighter fluid, kerosene or other flammable liquids to start or freshen a fire in this heater. Keep all such liquids well away from the stove while it is in use.

3.9. WOOD

Logs of the correct size for the stove allow for better stacking, filling and operation of your stove (page 16). Use dry wood which, by definition, is wood which has been dried under cover for more than 18 months so that the logs contain less than 20% moisture.

Heating the air in a closed building decreases the relative humidity of the air, which will dry wood and other combustible materials. This drying lowers the ignition temperature of these material, thus increasing the fire hazard. To reduce the risk of fire, some provision should be made for replenishing moisture to the air whenever a structure is being heated for extended periods.

Use dry wood

Some types of wood are easier to light than others. The best fire wood, and easiest to light, is always dry wood. Using dry wood will minimise creosote build-up. Damp wood has far less heating power. This lowers the combustion temperature of the fire, and therefore the output. It is difficult to light, burns badly and gives off smoke. Above all, the use of damp wood causes the formation of deposits (tarring and soot staining) in the chimney flue and on the glass door.

Flue gas temperature

The most important aspect of stove operation is maintaining a high combustion temperature. If the combustion of the fuel is at the correct temperature, most of the soot and tars (hydrocarbons) are burned. These hydrocarbons, when not burned, can be seen as tar and creosote deposits on the internal surfaces of the stove, glass and chimney surfaces.

Running your stove at maximum for prolonged periods will chill the stove as the air passage through the combustion chamber will be too fast to heat up and maintain the temperature within the stove. The operator will soon become acquainted with the optimum setting for the maximum heat production from their stove without the use of any surface or flue thermometer.

High combustion temperatures are the secret to clean glass operation. When loading wood, add one or two logs at a time, depending on size. Loading the appliance full of damp wood on a low fire is certain to cause poor combustion efficiency, resulting in tar and dirty glass.

It is recommended that you heat your stove to at least 205°C (400°F) before reducing the air controls. This procedure should always be carried out after reloading. A simple guide to this is when the new charge of fuel is burning vigorously.

Storage time for wood

Wood supplied in ready-cut lengths stored immediately under a ventilated shelter dries quicker than wood stocked in high piles. Quarters (split wood) dry quicker than round logs. Wood which is too small to split must be dried, by removing some of the bark. Round logs left in the open for more than a year end up rotten. The drying time for the fire wood should be at least 18 months to 2 years. This period can be shortened (12 to 15 months) if the wood is cut to the right length and immediately stored under a ventilated shelter. Using a moisture meter will take the guess work out of storing your wood.

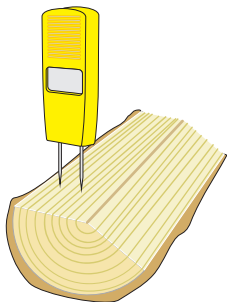

4. SAFETY

Notify the elderly, as well as children of the high surface temperature of the stove in order to avoid burns. Supervise children when they are in the room where the stove is placed and use a suitable fire guard for it. It is essential that the controls of the stove, as well as the chimney pipes are always clean and in good condition. The stove must be checked before use, as well as the chimney cleaned at least once a year. You should do this operation more often if the stove does not turn on regularly, the installation is poor or low quality fuel is used.

ATTENTION: The stove is very hot during operation. Do not touch the surface. Furniture and other combustible materials must keep the necessary safety distance (Fig. 21).

Do not overload the stove. If any part of the stove or chimney begins to glow or change colour, it means that you are overheating the stove. If you detect overheating of the stove, turn the air control to minimum to avoid damaging the cast iron parts.

Please, follow these recommendations:

- Do not load more fuel.
- Open the door of your stove slightly so that more air enters. This will initially cause the flames to grow and consume the fuel more quickly, but it will also cool the chimney and reduce the draft, cooling the stove.

Unattended fires

Many fires have happened by having a stove on and unattended for a long period of time. These fires usually occur because there are combustible materials near the stove, they heat up more than normal when the stove fire is oversized. The intensity of the fire depends on several factors.

One of these factors is air and usually increasing the air increases the fire. In the same way that if we increase the intensity of the fire, the air will also increase.

The air can also be affected by external factors such as wind, outside temperature, air currents ... if one of these factors changes, the air in the stove will change. This will cause temperatures to rise dangerously, which can cause nearby combustible materials to ignite.

Closing the air control button will not ensure that this cannot happen. You must exercise extreme caution if the fire is left unattended.

Procedure to follow in case of a chimney fire

A. Prepare to evacuate to ensure everyone's safety. Have a well-understood plan of action for evacuation. Have a place outside where everyone is to meet.

B. Close all the air controls on the stove.

C. Call the fire department. Have a fire extinguisher handy.

D. After the chimney fire is out, the chimney must be cleaned and checked for stress and cracks before re-use. Also check combustibles around the chimney and the roof.

Contact your local municipal or provincial fire authority for more information on how to handle a chimney fire. It is extremely important to have a clear plan on how to handle a chimney fire.

Minimum clearances to combustible materials

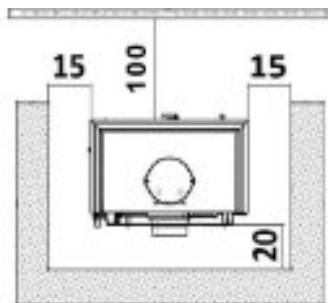

Safety distances S/H-13 models

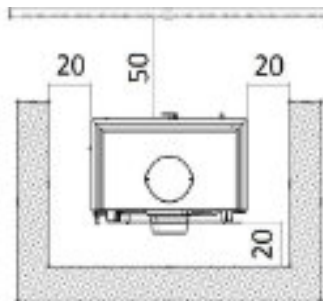

Safety distances S/H-23 models

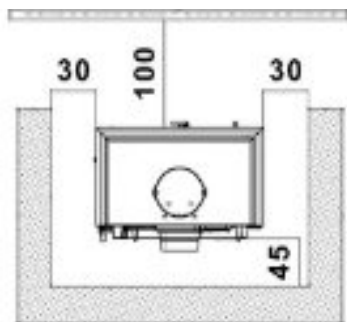

Safety distances S/H-33 models

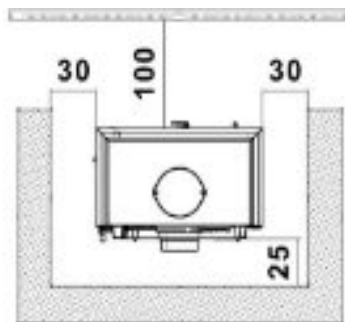

Safety distances S/H-43 models

Fig. 21

LOG SIZES

Stove model

Size 13
Size 23
Size 33
Size 43

Ideal Log Length

8 inches, 200mm
8 inches, 200mm
9 inches, 220mm
10 inches, 250mm

Maximum Log Length

12 inches, 300mm
13 inches, 330mm
15 inches, 367mm
17 inches, 432mm



5. CLEANING & MAINTENANCE

WARNING: DO NOT CLEAN A STOVE WHILE HOT.

Always keep the area around the unit clean and clear of furniture and other objects. Keep all furniture and drapery a minimum of one metre from the stove. Clean the stoves surface using light strokes of a real bristle paint brush. Stoves with a cast black finish should never be cleaned with a cloth as the texture of the paint will abrade and collect lint from the cloth which will be almost impossible to remove. Stoves with an enamel finish should be cleaned with a damp cloth, or very gentle use of a cleaner recommended for enamel finishes. In case of condensation, clean the affected areas before they dry.

Inspect the entire unit frequently for proper operation, fit and soundness of parts. If any malfunctioning, cracked, broken, or loose parts or other problems are noted, contact your dealer or qualified serviceman to inspect and repair the unit. **DO NOT OPERATE THE UNIT IF INSTALLED OR FUNCTIONING IMPROPERLY.**

Seals

Check the fit and seal of the doors and ash pan door frequently. For proper operation an airtight seal must be maintained around these openings. If the seal is not tight, inspect the gasket. If the gasket needs replacement, contact your dealer. If the gasket is in good condition, check the closure latch screws; if these are loose, adjust the door handle (Fig. 23).

Glass

Your stove is fitted with 4 mm ceramic glass. Properly operated, your glass door will not get coated with thick tar like conventional stoves. If this does occur, you may have to resort to using a glass cleaner. However, by using dry wood, much of the tar on the glass will burn clean, when the appliance is run at high temperature.

Clean the ceramic glass when cold, using commercial products sold for this purpose, or warm water with a drop of vinegar.

The glass used in your stove is not toughened glass but ceramic, which can only be broken due to a strong blow or a bad use. Inspect the glass regularly. If it is damaged, replace the glass using a new glass seal kit immediately.

WARNING: Replacement of damaged glass must be done with original parts supplied by your dealer. Use of other materials could cause a safety hazard and void your warranty.

CAUTION: NEVER OPERATE YOUR STOVE WITH BROKEN GLASS.

Replacement of the glass:

1. Open the door. Lift off the stoves body.
2. Remove the 4 fixing screws and remove the glass



and old seals.

3. Replace the seals and glass.
4. Install the 4 screws. Do not over tighten the screws.

Note: When replacing glass, always replace glass seals

Any maintenance or adjustment, not described in this manual, must be performed by a trained and competent technical service engineer.

Door handle adjustment (see Fig. 23)

The stove is equipped with an adjustable door latch. For correct operation, the stove door must be airtight when closed.

To adjust the door handle latch:

1. Loosen the locking nut.
2. Adjust the bolt in or out as required. The adjustment should be made in such away that when the handle is in its closed position the door is airtight and the handle vertical.
3. Re-tighten the locking nut.

Catalyst Maintenance and Removal for Sweeping



The catalyst should be removed and inspected at least once during the heating season to ensure clean combustion is occurring. A build up of tar and soot can reduce the effectiveness of the catalysts cleaning properties.

Cleaning the catalyser may be done using a vacuum cleaner on both sides. You can also use a soft bristled brush (like a paint brush). If your catalyst seems plugged with ash even after brushing or vacuuming, you can gently clean the cells with a pipe cleaner.

We do not recommend that you clean your catalyser with an air compressor unless you can ensure a very low pressure. Using high pressure air to blow the cell free of fly ash build up can also blow off the catalysts metal coating inside the cells. However, the compressed air that comes in a can may be used very effectively.

Removal H13 S13 vertical exit



The housing containing the catalyst can be removed from the stove. Take out the vermiculite baffle in the top of the stove which will give you access to the housing. Using a 4mm Allen key remove the 2 screws holding the housing to the support brackets on either side.

It is also possible to remove the 2 bolts holding the housing to the top of the stove and then withdrawing the housing the stove. The catalyst may then be removed for cleaning.

Removal H13 S13 horizontal exit



The catalyser box for rear exit of the stove is again held in place by 2 bolts. Remove the vermiculite top baffle and then the bolts. The box can then be withdrawn from the stove.

Removal H23 S23 vertical exit

To remove the catalyser for cleaning in these models you will need to have a 3mm Allen key for the catalyser retaining screw and a 4mm Allen key for the 2 screws on the flue gas diverter flap.

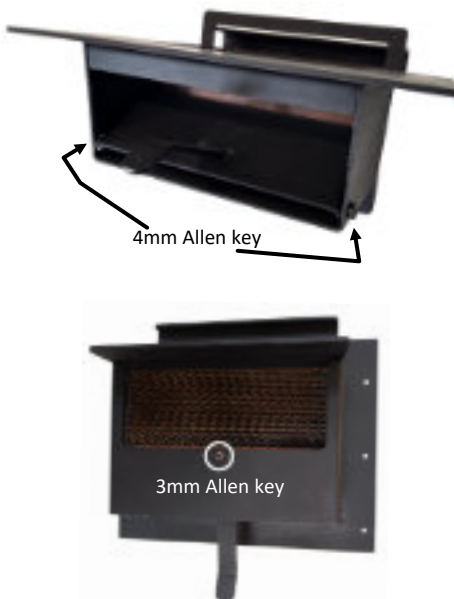

Locate the screw under the catalyst box and remove it using the 3mm Allen key.

Using the 4mm Allen key remove the 2 screws holding the flue gas diverter flap. Remove this from the box.

The catalyst can then be withdrawn from the box for cleaning.

If the catalyser box needs to be removed the retaining bolts in the roof of the stove need to be taken out and the box withdrawn.

Removal H23 S23 horizontal exit



The catalyser box for rear exit of the stove is again held in place by 2 bolts. Remove the vermiculite top baffle and then the bolts. The box can then be withdrawn from the stove.

Removal H33/43 S22/43 vertical exit

To remove the catalyser for cleaning in these models you will need to have a 3mm Allen key for the catalyser retaining screw and a 4mm Allan key for the 2 screws on the flue gas diverter flap.

The removal of the catalyser and box is similar to the H23 S23 the box is just bigger and there are 2 catalyses within the box.

Locate the screw under the catalyst box and remove it using the 3mm Allen key.

Using the 4mm Allen key remove the 2 screws holding the flue gas diverter valve. Remove this from the box.

The catalyst can then be withdrawn from the box for cleaning.

If the catalyser box needs to be removed the retaining bolts in the roof of the stove need to be taken out and the box withdrawn.



Removal H33/43 S33/43 horizontal exit

The catalyser box for rear exit of the stove is again held in place by 2 bolts. Remove the vermiculite top baffle and then the bolts. The box can then be withdrawn from the stove.

IMPORTANT:

The stove must never be used without the catalyser box and catalyses fitted as this could cause over firing and damage the stove.

The life expectancy of the catalyst is about 4 to 5 years depending upon use of the stove and the quality of the wood being used.

Burn only dry, seasoned wood, with a moisture content of 20 percent or less. Season wood at least six months; store outdoors, loosely covered, to allow air to circulate freely through the pile. "Green" or wet wood releases less heat because energy from the fire must first evaporate the moisture before producing useful heat.

Build and maintain moderately hot fires quickly after loading the wood. A hot initial fire will help your catalyst reach operating temperature faster. Once "lit", the catalyst will stay "lit" even if the fire burns lower. Catalyst temperatures of 500°C or more are typical in normal operation. Once a catalyst is "lit" it will stay lit at temperatures of about 200°C.

Burning moderate to full loads of wood providing several hours of uninterrupted burning. Minimising door openings allows the temperatures to stay high, which reduces pollution. Frequent door openings allows cold air into the stove and cools the catalyser.

Operate your stove in the bypass mode initially so that smoke bypasses the catalyst. Wait until the stove is hot enough before engaging the catalyst, but be careful not to overheat the stove. The reason for this is that, to some extent, the catalyst may reduce the draft. With poor flue draft, the fire will take longer to develop and the catalyst will take longer to become "lit".



Don't over fire your stove, especially when the catalyst is engaged. Avoid excessive catalyst temperatures. This is another reason to use a flue temperature gauge. Catalysts can be damaged or destroyed by prolonged excess heat.

Don't open the ash pan door while the stove is lit because this will lead to overheating and damage the catalyser.

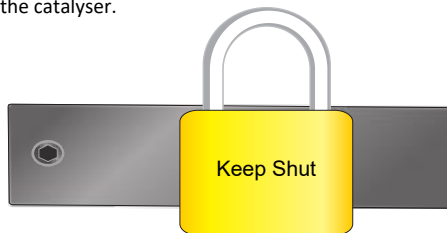

Check door rope seals regularly to ensure no uncontrolled air is entering the stove leading to over firing. Check for catalyst deterioration by either of these two methods:

1) Observe the chimney, both before and after the catalyst has engaged, to determine if the catalyst has reduced the amount of smoke being emitted from the chimney. If the sky provides a solid light background, you should be able to see a difference between the smoke from a stove before and after the catalyst is engaged.

2) Inspect the inside of the chimney for creosote buildup. Although there will still be some creosote buildup from operating catalytic stoves properly, the rates of buildup should be much lower than in conventional stoves. Your chimney sweep will be able to help you ascertain this.



A replacement catalyser can be obtained from your local Nestor Martin dealer or directly from Eurostoves spare parts website.

Catalyst part number: N91300-55-03-99-00

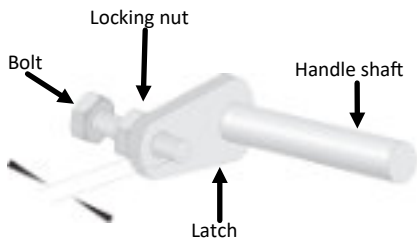

Fig. 23

Brass fittings

Any proprietary brass cleaner may be used to clean the brass on the stove, but care must be taken to ensure the polish does not come into contact with the stove enamel or the black cast finish, where it will leave a stain.

Nickel fittings

Any proprietary chrome or aluminium cleaner may be used to clean the decorative fittings on the stove, but care must be taken to ensure the polish does not come into contact with the stove enamel or the black cast finish, where it will leave a stain.

Soot

When wood is burned slowly, it produces tar and other organic vapours, which combine with expelled moisture to form creosote. The creosote vapours condense in the relatively cool chimney flue of a slow burning fire. As a result, creosote residue accumulates on the flue lining. When ignited, this creosote makes an extremely hot fire.

The chimney connector and chimney should be inspected at least once every two months during the heating season to determine if a creosote build-up has occurred. The chimney connector must be in good condition and kept clean. If creosote has accumulated (1/8" (3 mm) or more) it should be removed to reduce the risk of a chimney fire. Experienced chimney servicing personnel should be consulted. Establish a routine for the fuel, wood burner and firing technique. Check daily for creosote build-up until experience shows how often you need to clean to be safe. Be aware that the hotter the fire, the less creosote is deposited. Weekly cleaning may be necessary in mild weather even though monthly cleaning may be enough in the coldest months.

AT THE END OF THE SEASON

Clean the unit, the flue outlet, and the chimney at the end of each heating season or more often if the use of the stove, or the fuel make it necessary. For cleaning purposes the baffle plates can be removed without any tools. This gives access to the cleaning flap of the smoke flue and it is even possible to reach the flue outlet. It also allows the removal of the catalyst box on the TruHybrid variants for examination and sweeping of the flue.

Ashes shall be removed, and disposed of in a steel container with a tightly fitting lid and moved outdoors immediately. Remove all internal parts to expose any remaining ash and cinders and remove, close all the stove doors. If the room is damp, possibly place some absorbent crystals inside the stove or spray any internal metal surfaces with water repelling spray.

Using a suitable oil lubricate all moving parts including door latches and handle shafts.

Enamelled parts and repair

Porcelain enamel, when heated to high temperature, is subject to crazing. Crazing is a normal occurrence when enamel is exposed to high temperatures. Your enamel finish will not be harmed nor will the function of the stove be impaired.

The enamel surface of the stove may become chipped if it is hit with a hard object such as a coal shovel or operating tool. Suitable cold enamel touch up paint may be purchased.

To prepare the surface remove any loose or flaking enamel finish and brush or vacuum the area to remove any dust and dirt.

If the touch up is supplied in a bottle shake vigorously for a minute to mix the contents.

If supplied in a tube squeeze out some of the contents onto a clean sheet of paper and mix with a match stick as it may have become separated in the tube. Apply a thin layer of touch up to the surface allowing it to dry before applying further layers to build the surface up to the surrounding enamels height. Leave to dry before firing the stove.

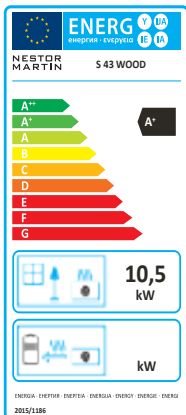
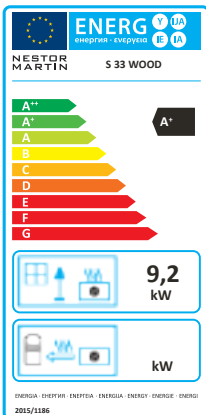
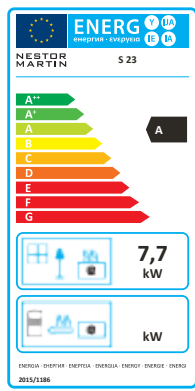
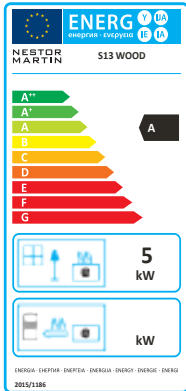
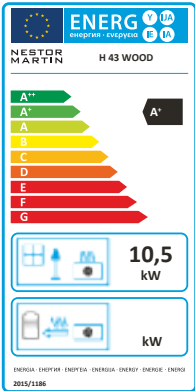
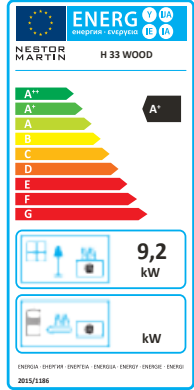
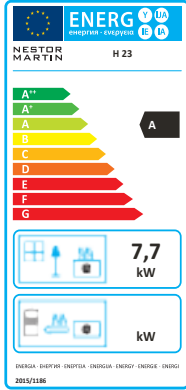
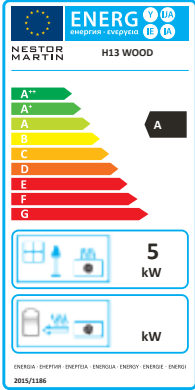

Service Record

Date

Service Engineers Name

Company

Notes

Date

Service Engineers Name

Company

Notes

Date

Service Engineers Name

Company

Notes

Date

Service Engineers Name

Company

Notes

Date

Service Engineers Name

Company

Notes





Distributed and supported in the UK by

Eurostove Ltd

Unit H1,
Mendip Industrial Estate,
Mendip Road,
Rooksbridge,
Somerset
BS26 2UG

Tel: 01934 750 500

Fax: 01173 156 207

www.eurostove.co.uk

E-mail : info@eurostove.co.uk



Product code: N91300-49-00-99-00

Version Number: V1



0691046764195

