

LAGUNA

OWNERS'S MANUAL

Fusion 3 Table Saw

36" & 52" Fence



Thank you for investing in a Fusion Saw by Laguna Tools. This table saw is one of a family of unique machines proudly offered by Laguna Tools. Every Laguna machine is engineered for years of dependable service. Please feel free to contact Laguna Tools if you have a question or suggestion. We appreciate working with you and your choice of a Laguna Tools machine for your shop.

Regards,
Torben Helshoj
President & Founder Laguna Tools

Laguna takes pride in our products and stands behind them with continuing service and support for our customers. Your Laguna machine was designed to bring a new dimension of productivity to your shop.

Before using your machine for the first time, learn how to use it. This manual covers a step-by-step process of assembly and machine operation. If you have any questions, this manual will provide answers.

We do our best to thoroughly document every product that we sell for customer reference. Several files are compiled to cover all components of a machine.

Several machines may be covered by one manual.

Many machines sold by Laguna include components with independent owners' manuals.

The information contained in this publication was correct at the time of print. In the interest of continuous innovation, we reserve the right to change specifications, design or included equipment without notice or obligation. No part of this publication may be reproduced, transmitted, or translated into any language in any form by any means without our written permission. Errors and omissions may be current.

Laguna Tools, Inc. LAGUNA® and the LAGUNA Logo® are the registered trademarks of Laguna Tools, Inc. All rights reserved. 04/01/2019

LAGUNA

LAGUNA AMERICAN HEADQUARTERS

Texas: 744 Refuge Way Suite 200, Grand Prairie, Texas 75050, U.S.A. Phone: +1-800-332-4094

Huntington Beach: 7291 Heil Ave Huntington Beach, CA 92647, U.S.A. Phone: +1-949-474-1200

South Carolina: 825 Bistline Dr. Ste 101, West Columbia, SC 29172, U.S.A. Phone: +1-800-234-1976

Minnesota: 5250 West 74th St, Edina, MN 55439, U.S.A Phone: +1-949-474-1200

lagunatools.com

supermaxtools.com

lagunacleanair.com

lagunalathe.com

LAGUNA EUROPE

Walker Rd, Bardon Hill, Coalville LE67 1TU, United Kingdom. Phone: +44-1530-516921

lagunatools.uk

DAKE CORPORATION

724 Robbins Road, Grand Haven, MI 49417, United States +1-800-937-3253

dakecorp.com

Table of Contents

Safety.....	4
Electrical Safety.....	9
Safety (FRENCH).....	13
Setup	16
Inventory List	17
Unboxing.....	21
Front Rail	24
Rear Rail	28
Right Extension Table	32
Rear Extension Table	34
Front Rail Pt. 2 & Control Switch	37
Accessory Installation	41
Maintenance	49
Troubleshooting.....	52
Specifications	53
Wiring Diagram	59
Parts Diagram.....	60
Parts List.....	65
Warranty	76

Safety

Read and understand all warnings and operation instructions before using any tool or equipment. Always follow basic safety precautions to reduce the risk of personal injury. Improper operation, maintenance or modification of tools or equipment could result in serious injury and property damage. There are certain applications for which tools and equipment are designed. This product should NOT be modified and/or used for any application other than for which it was designed. It is important for you to read and understand this manual. The information it contains relates to protecting your safety and preventing problems.



Safety Guidelines - Definitions

This manual contains information this is vital to protecting your safety and preventing equipment problems. To help you recognize this information, we use the symbols below. Please read the manual and pay attention to these sections.

Safety Call-outs











 **DANGER** An imminently hazardous situation which, if not avoided, will result in death or serious injury. Sometimes displayed as  **DANGER!**

 **WARNING** A potentially hazardous situation which, if not avoided, could result in death or serious injury. Sometimes displayed as  **WARNING!**

 **CAUTION** A potentially hazardous situation which, if not avoided, may result in minor or moderate injury. Sometimes displayed as  **CAUTION!**

 **NOTICE** A helpful tip from our technical staff. Sometimes displayed as **NOTICE!**

Safety Symbols

- | | | | |
|--|--|---|--------------------------|
|  | Disconnect from power before proceeding. |  | Wear ear protection. |
|  | Be aware of possible laceration danger. |  | Wear Eye Protection. |
|  | Be aware of possible crushing danger. |  | Wear a full face shield. |
|  | Be aware of possible crushing danger. |  | Wear lung protection. |
|  | Electrical Hazard. |  | Requires X People |



WARNING

Important Safety Instructions

Read and understand all warnings and operating instructions before using this equipment.

Failure to follow all instructions listed below, may result in electric shock, fire, and/or serious personal injury or property damage.

Woodworking can be dangerous if safe and proper operating procedures are not followed. As with all machinery, there are certain hazards involved with the operation of the product. Using the machine with respect and caution will considerably lessen the possibility of personal injury. However, if normal safety precautions are overlooked or ignored, personal injury to the operator may result. Safety equipment such as guards, push sticks, hold-downs, feather boards, goggles, dust masks and hearing protection can reduce your potential for injury. But even the best guard won't make up for poor judgment, carelessness or inattention. Always use common sense and exercise caution in the workshop. If a procedure feels dangerous, don't try it. Figure out an alternative procedure that feels safer. **REMEMBER:** Your personal safety is your responsibility.

This machine was designed for certain applications only. We strongly recommend that this machine not be modified and/or used for any application other than that for which it was designed. If you have any questions relative to a particular application, do not use the machine until you have first contacted the manufacturer to determine if it can or should be performed on the product.

If you have any questions relative to its application do not use the product until you have contacted the manufacturer and we have advised you.



WARNING

General Safety Rules

FAILURE TO FOLLOW THESE RULES MAY RESULT IN SERIOUS PERSONAL INJURY.

FOR YOUR OWN SAFETY, READ AND UNDERSTAND THE INSTRUCTION MANUAL BEFORE OPERATING THE MACHINE.

Learn the unit's application and limitations as well as the specific hazards peculiar to it.

KEEP WORK AREA CLEAN. Cluttered areas and benches invite accidents.

DON'T USE IN DANGEROUS ENVIRONMENT. Don't use this unit in damp or wet locations or expose it to rain. Keep work area well-lighted.

KEEP CHILDREN AND VISITORS AWAY. All children and visitors should be kept a safe distance from work area.

DISCONNECT UNIT before servicing.

CHECK DAMAGED PARTS. Before further use of the unit, properly repair or replace any part that is damaged.



DANGER

CSA Required Safety Information: Table Saws

For Your Own Safety Read Instruction Manual before Operating Tablesaw.

- a) **⚠ DANGER!** Never place your hands in the vicinity or in line with the saw blade.
- b) **⚠ WARNING!** "Wear eye protection" or the sign M004 of ISO 7010.
- c) **⚠ WARNING!** Always use a properly functioning saw-blade guard, riving knife and anti-kickback device for every operation for which it can be used, including all through sawing.
- d) **⚠ WARNING!** Use a push-stick or push-block when required.
- e) **⚠ WARNING!** Do not perform any operation freehand.
- f) **⚠ WARNING!** Pay particular attention to instructions on reducing risk of kickback.
- g) **⚠ WARNING!** Never reach around or over saw blade.
- h) **⚠ WARNING!** Turn off tool and wait for saw blade to stop before moving workpiece or changing settings.
- i) **⚠ WARNING!** Never stand directly in line with the saw blade. Always position your body on the same side of the saw blade as the fence.

In addition, use hearing protection and wear gloves when handling saw blades.

**WARNING****Guarding Related Warnings**

- a) Keep guards in place. Guards must be in working order and be properly mounted. A guard that is loose, damaged, or is not functioning correctly must be repaired or replaced.
- b) Always use saw blade guard, riving knife and anti-kickback device for every through-cutting operation. For through-cutting operations where the saw blade cuts completely through the thickness of the workpiece, the guard and other safety devices help reduce the risk of injury.
- c) Immediately reattach the guarding system after completing an operation (such as rabbeting, dadoing or resawing cuts) which requires removal of the guard, riving knife and/or anti-kickback device. The guard, riving knife, and anti-kickback device help to reduce the risk of injury.
- d) Make sure the saw blade is not contacting the guard, riving knife or the workpiece before the switch is turned on. Inadvertent contact of these items with the saw blade could cause a hazardous condition.
- e) Adjust the riving knife as described in this instruction manual. Incorrect spacing, positioning and alignment can make the riving knife ineffective in reducing the likelihood of kickback.
- f) For the riving knife and anti-kickback device to work, they must be engaged in the workpiece. The riving knife and anti-kickback device are ineffective when cutting workpieces that are too short to be engaged with the riving knife and anti-kickback device. Under these conditions a kickback cannot be prevented by the riving knife and antikickback device.
- g) Use the appropriate saw blade for the riving knife. For the riving knife to function properly, the saw blade diameter must match the appropriate riving knife and the body of the saw blade must be thinner than the thickness of the riving knife and the cutting width of the saw blade must be wider than the thickness of the riving knife.

**DANGER****Cutting Procedures Warnings**

- a) **⚠ DANGER!** Never place your fingers or hands in the vicinity or in line with the saw blade. A moment of inattention or a slip could direct your hand towards the saw blade and result in serious personal injury.
- b) Feed the workpiece into the saw blade or cutter only against the direction of rotation. Feeding the workpiece in the same direction that the saw blade is rotating above the table may result in the workpiece, and your hand, being pulled into the saw blade.
- c) Never use the miter gauge to feed the workpiece when ripping and do not use the rip fence as a length stop when cross cutting with the miter gauge. Guiding the workpiece with the rip fence and the miter gauge at the same time increases the likelihood of saw blade binding and kickback.
- d) When ripping, always apply the workpiece feeding force between the fence and the saw blade. Use a push stick when the distance between the fence and the saw blade is less than 150 mm and use a push block when this distance is less than 50 mm. "Work helping" devices will keep your hand at a safe distance from the saw blade.
- e) Use only the push stick provided by the manufacturer or constructed in accordance with the instructions. This push stick provides sufficient distance of the hand from the saw blade.
- f) Never use a damaged or cut push stick. A damaged push stick may break causing your hand to slip into the saw blade.
- g) Do not perform any operation "freehand". Always use either the rip fence or the miter gauge to position and guide the workpiece. "Freehand" means using your hands to support or guide the workpiece, in lieu of a rip fence or miter gauge. Freehand sawing leads to misalignment, binding and kickback.
- h) Never reach around or over a rotating saw blade. Reaching for a workpiece may lead to accidental contact with the moving saw blade.
- i) Provide auxiliary workpiece support to the rear and/or sides of the saw table for long and/or wide workpieces to keep them level. A long and/or wide workpiece has a tendency to pivot on the table's edge, causing loss of control, saw blade binding and kickback.
- j) Feed workpiece at an even pace. Do not bend or twist the workpiece. If jamming occurs, turn the tool off immediately, unplug the tool then clear the jam. Jamming the saw blade by the workpiece can cause kickback or stall the motor.

- k) Do not remove pieces of cut-off material while the saw is running. The material may become trapped between the fence or inside the saw blade guard and the saw blade pulling your fingers into the saw blade. Turn the saw off and wait until the saw blade stops before removing material.
- l) Use an auxiliary fence in contact with the tabletop when ripping workpieces less than 2 mm thick. A thin workpiece may wedge under the rip fence and create a kickback.



DANGER

Kickback Causes and Related Warnings

Statistics show that most common accidents among table saw users can be linked to kickback. Kickback is a sudden reaction of the workpiece due to a pinched, jammed saw blade or misaligned line of cut in the workpiece with respect to the saw blade or when a part of the workpiece binds between the saw blade and the rip fence or other fixed object.

Most frequently during kickback, the workpiece is lifted from the table by the rear portion of the saw blade and is propelled towards the operator.

Kickback is the result of saw misuse and/or incorrect operating procedures or conditions and can be avoided by taking proper precautions as given below:

- a) **⚠ DANGER!** Never stand directly in line with the saw blade. Always position your body on the same side of the saw blade as the fence. Kickback may propel the workpiece at high velocity towards anyone standing in front and in line with the saw blade.
 - b) **⚠ DANGER!** Never reach over or in back of the saw blade to pull or to support the workpiece. Accidental contact with the saw blade may occur or kickback may drag your fingers into the saw blade.
 - c) **⚠ DANGER!** Never hold and press the workpiece that is being cut off against the rotating saw blade. Pressing the workpiece being cut off against the saw blade will create a binding condition and kickback.
 - d) Align the fence to be parallel with the saw blade. A misaligned fence will pinch the workpiece against the saw blade and create kickback.
 - e) Use a feather-board to guide the workpiece against the table and fence when making non-through cuts such as rabbeting, dadoing or resawing cuts. A feather-board helps to control the workpiece in the event of a kickback.
 - f) Use extra caution when making a cut into blind areas of assembled workpieces. The protruding saw blade may cut objects that can cause kickback.
 - g) Support large panels to minimize the risk of saw blade pinching and kickback. Large panels tend to sag under their own weight. Support(s) must be placed under all portions of the panel overhanging the table top.
 - h) Use extra caution when cutting a workpiece that is twisted, knotted, warped or does not have a straight edge to guide it with a miter gauge or along the fence. A warped, knotted, or twisted workpiece is unstable and causes misalignment of the kerf with the saw blade, binding and kickback.
 - i) Never cut more than one workpiece, stacked vertically or horizontally. The saw blade could pick up one or more pieces and cause kickback.
 - j) When restarting the saw with the saw blade in the workpiece, center the saw blade in the kerf so that the saw teeth are not engaged in the material. If the saw blade binds, it may lift up the workpiece and cause kickback when the saw is restarted.
 - k) Keep saw blades clean, sharp, and with sufficient set. Never use warped saw blades or saw blades with cracked or broken teeth. Sharp and properly set saw blades minimize binding, stalling and kickback.
-



WARNING

Table Saw Operating Procedure Warnings

1. Turn off the table saw and disconnect the power cord when removing the table insert, changing the saw blade or making adjustments to the riving knife, anti-kickback device or saw blade guard, and when the machine is left unattended. Precautionary measures will avoid accidents.
2. Never leave the table saw running unattended. Turn it off and don't leave the tool until it comes to a complete stop. An unattended running saw is an uncontrolled hazard.
3. Locate the table saw in a well-lit and level area where you can maintain good footing and balance. It should be installed in an area that provides enough room to easily handle the size of your workpiece. Cramped, dark areas, and uneven, slippery floors invite accidents.
4. Frequently clean and remove sawdust from under the saw table and/or the dust collection device. Accumulated sawdust is combustible and may self-ignite.
5. The table saw must be secured. A table saw that is not properly secured may move or tip over.
6. Remove tools, wood scraps, etc. from the table before the table saw is turned on. Distraction or a potential jam can be dangerous.
7. Always use saw blades with correct size and shape (diamond versus round) of arbor holes. Saw blades that do not match the mounting hardware of the saw will run off-center, causing loss of control.
8. Never use damaged or incorrect saw blade mounting means such as flanges, saw blade washers, bolts or nuts. These mounting means were specially designed for your saw, for safe operation and optimum performance.
9. Never stand on the table saw, do not use it as a stepping stool. Serious injury could occur if the tool is tipped or if the cutting tool is accidentally contacted.
10. Make sure that the saw blade is installed to rotate in the proper direction. Do not use grinding wheels, wire brushes, or abrasive wheels on a table saw. Improper saw blade installation or use of accessories not recommended may cause serious injury.

Electrical Safety

Power Connections

A separate electrical circuit should be used for your machines. This circuit should not be less than the wiring listed below and should be protected with an appropriate circuit breaker based on the total running and start-up amperage's (listed below). If an extension cord is used, use only 3-wire extension cords which have 3-prong grounding type plugs and matching receptacle which will accept the machine's plug.

 DANGER Before connecting the machine to the power source, make sure the switch is in the “OFF” position.

MTSF3362203-0130-36	
VOLTAGE	220V
PHASE	1PH
HERTZ	60Hz
FULL LOAD AMPERAGE	14.8A
<p>⚠ WARNING! Below are RECOMMENDATIONS to be used for this machine based on the above information. Variables outside of our control are:</p> <ul style="list-style-type: none"> • Actual voltage supplied to the machine • Electrical code that must be met in your local province. <p>An electrician will verify that all the demands are met to properly wire the machine. If you have absolutely any doubt when wiring this machine - please consult with a qualified electrician.</p>	
PLUG/RECEPTACLE	6-15
WIRING (Gauge)	14 Ga. (minimum)
CIRCUIT BREAKER / (Fuse)	20AMP / (20 AMP Slow Blow)

MTSF3362203-0130-52	
VOLTAGE	220V
PHASE	1PH
HERTZ	60Hz
FULL LOAD AMPERAGE	14.8A
<p>⚠ WARNING! Below are RECOMMENDATIONS to be used for this machine based on the above information. Variables outside of our control are:</p> <ul style="list-style-type: none"> • Actual voltage supplied to the machine • Electrical code that must be met in your local province. <p>An electrician will verify that all the demands are met to properly wire the machine. If you have absolutely any doubt when wiring this machine - please consult with a qualified electrician.</p>	
PLUG/RECEPTACLE	6-15
WIRING (Gauge)	14 Ga. (minimum)
CIRCUIT BREAKER / (Fuse)	20AMP / (20 AMP Slow Blow)



WARNING

If this information is different than what is stated on the Motor Specification Plate - omit this information. It is possible that the documentation is outdated to a machine change - such as a different motor. **Always check the motor plate prior to any wiring. If any doubts, please consult a certified electrician.**



CAUTION

Know when to use a time delay fuse! AKA Slow blow fuse.

Generally, if the motor uses a start capacitor, a time delay fuse is required. This type of fuse (circuit breaker) will not trip with the initial amperage needed to start the machine, which is typically double that of the running amperage. **Most woodworking machines use this type of fuse.**



CAUTION

Running on Low voltage will damage the machine. Never run the machine in wet or damp conditions.

NOTICE

For a detailed wiring diagram please see the [Wiring Diagram](#) section at the end of this manual.

Grounding Methods



DANGER

This machine must be grounded while in use to protect the operator from electric shock.



DANGER

In all cases, make certain that the receptacle in question is properly grounded. If you are not sure, have a qualified electrician check the receptacle.

Grounding Methods Provided by CSA Group. (A) Receptacle with nominal rating less than 150 volts. (B) 150 volt receptacle without grounding pin fitted with adapter.

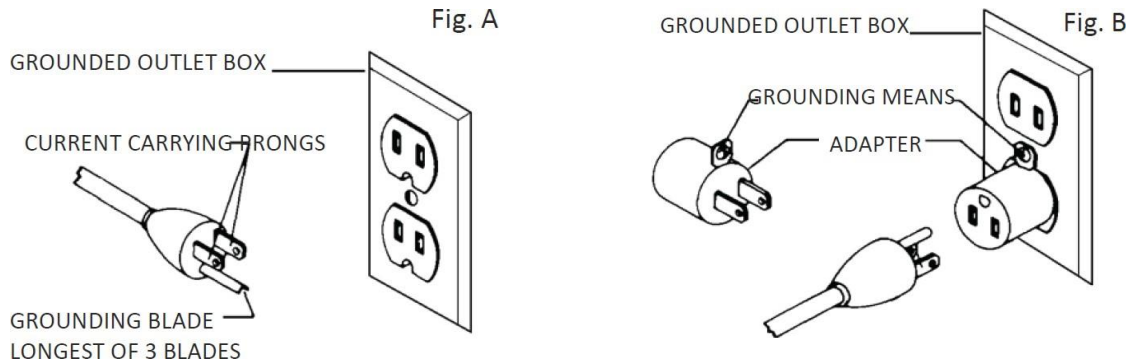

1. All grounded, cord-connected machines:

In the event of a malfunction or breakdown, grounding provides a path of least resistance for electric current to reduce the risk of electric shock. This machine is equipped with an electric cord having an equipment-grounding conductor and a grounding plug. The plug must be plugged into a matching outlet that is properly installed and grounded in accordance with all local codes and ordinances.

Do not modify the plug provided - if it will not fit the outlet, have the proper outlet installed by a qualified electrician. Improper connection of the equipment-grounding conductor can result in risk of electric shock. The conductor with insulation having an outer surface that is green with or without yellow stripes is the equipment-grounding conductor. If repair or replacement of the electric cord or plug is necessary, do not connect the equipment-grounding conductor to a live terminal.

Check with a qualified electrician or service personnel if the grounding instructions are not completely understood, or if in doubt as to whether the machine is properly grounded.

Use only 3-wire extension cords that have 3-prong grounding type plugs and matching 3-conductor receptacles that accept the machine's plug, as shown in Fig. A. Repair or replace damaged or worn cord immediately.

2. Grounded, cord-connected machines intended for use on a supply circuit having a nominal rating less than 150 volts:

If the machine is intended for use on a circuit that has an outlet that looks like the one illustrated in Fig. A, the machine will have a grounding plug that looks like the plug illustrated in Fig. A. A temporary adapter, which looks like the adapter illustrated in Fig. B, may be used to connect this plug to a matching 2-conductor receptacle as shown in Fig. B if a properly grounded outlet is not available. The temporary adapter should be used only until a properly grounded outlet can be installed by a qualified electrician. The green-colored rigid ear, lug, and the like, extending from the adapter is used, it must be held in a place with a metal screw. NOTE: In Canada, the use of a temporary adapter is not permitted by the Canadian Electric Code.

Extension Cords

⚠ WARNING! Use proper extension cords. Make sure your extension cord is in good condition and is a 3-wire extension cord which has a 3-prong grounding type plug and matching receptacle which will accept the machine's plug. When using an extension cord, be sure to use one heavy enough to carry the current of the machine. An undersized cord will cause a drop in line voltage, resulting in loss of power and overheating. Fig. D.1 or D.2, shows the correct gauge to use depending on the cord length. If in doubt, use the next heavier gauge. The smaller the gauge number, the heavier the cord.

MINIMUM GAUGE EXTENSION CORD 120V			
RECOMMENDED SIZES FOR USE WITH STATIONARY ELECTRIC MACHINES			
Ampere Rating	Volts	Total Length of Cord in Feet	Gauge of Extension Cord
0-6	120	up to 25	18 AWG
0-6	120	25-50	16 AWG
0-6	120	50-100	16 AWG
0-6	120	100-150	14 AWG
6-10	120	up to 25	18 AWG
6-10	120	25-50	16 AWG
6-10	120	50-100	14 AWG
6-10	120	100-150	12 AWG
10-12	120	up to 25	16 AWG
10-12	120	25-50	16 AWG
10-12	120	50-100	14 AWG
10-12	120	100-150	12 AWG
12-16	120	up to 25	14 AWG
12-16	120	25-50	12 AWG
12-16	120	GREATER THAN 50 FEET NOT RECOMMENDED	

MINIMUM GAUGE EXTENSION CORD 240V			
RECOMMENDED SIZES FOR USE WITH STATIONARY ELECTRIC MACHINES			
Ampere Rating	Volts	Total Length of Cord in Feet	Gauge of Extension Cord
0-6	240	up to 50	18 AWG
0-6	240	50-100	16 AWG
0-6	240	100-200	16 AWG
0-6	240	200-300	14 AWG
6-10	240	up to 50	18 AWG
6-10	240	50-100	16 AWG
6-10	240	100-200	14 AWG
6-10	240	200-300	12 AWG
10-12	240	up to 50	16 AWG
10-12	240	50-100	16 AWG
10-12	240	100-200	14 AWG
10-12	240	200-300	12 AWG
12-16	240	up to 50	14 AWG
12-16	240	50-100	12 AWG
12-16	240	GREATER THAN 100 FEET NOT RECOMMENDED	

Safety (FRENCH)

AVERTISSEMENT!

Pour votre propre sécurité, lisez le manuel d'instructions avant d'utiliser la scie à table.

- (a) DANGER - Ne placez jamais vos mains à proximité ou en ligne avec la lame de scie.
- (b) AVERTISSEMENT - "Porter une protection oculaire" ou le signe M004 de la norme ISO 7010.
- (c) AVERTISSEMENT - Toujours utiliser un protecteur de lame de scie, un couteau diviseur et un dispositif anti-retour pour chaque opération pour laquelle il peut être utilisé, y compris tout au long du sciage.
- (d) AVERTISSEMENT - Utiliser un bâton-poussoir ou un bloc-poussoir au besoin.
- (e) AVERTISSEMENT - N'effectuez aucune opération à main levée.
- (f) AVERTISSEMENT - Porter une attention particulière aux instructions sur la réduction du risque de rebond. (ou "Savoir comment réduire les risques de pots-de-vin.")
- (g) AVERTISSEMENT - Ne jamais tendre la main autour ou au-dessus de la lame de scie. (ou "Ne jamais tendre la main à l'arrière ou au-dessus de la lame de scie").
- (H) AVERTISSEMENT - Éteindre l'outil et attendre que la lame de scie s'arrête avant de déplacer la pièce ou de changer les réglages.
- (I) AVERTISSEMENT - Ne jamais se tenir directement en ligne avec la lame de scie. Placez toujours votre corps du même côté de la lame de scie que la clôture.

De plus, utilisez une protection auditive et portez des gants pour manipuler les lames de scie.

Avertissements relatifs à la protection

Laisser les protecteurs en place. Les protecteurs doivent être en état de fonctionnement et montés correctement. Un protecteur mal fixé, endommagé ou ne fonctionnant pas correctement doit être réparé ou remplacé.

Toujours utiliser un protecteur de lames, un couteau diviseur et un appareil antirecul pour toute opération de coupe traversante. Pour les opérations de coupe traversante où la lame traverse complètement l'épaisseur de la pièce, le protecteur et les autres appareils de sécurité contribuent à limiter le risque de blessure.

Fixer de nouveau immédiatement le protecteur après l'exécution d'une opération (telle que le refeuillement, l'engravure ou la refente) qui nécessite l'enlèvement du protecteur, du couteau diviseur et/ou de l'appareil anti-recul. Le protecteur, le couteau diviseur et l'appareil anti-recul contribuent à limiter le risque de blessure.

Veiller à ce que la lame n'entre pas en contact avec le protecteur, le couteau diviseur ou la pièce avant le déclenchement du commutateur. Un contact involontaire de ces éléments avec la lame pourrait entraîner un fonctionnement dangereux.

Ajuster le couteau diviseur comme décrit dans la notice d'utilisation. Un espacement, un positionnement et un alignement incorrects peuvent empêcher le couteau diviseur de limiter le risque de recul.

Pour que le couteau diviseur et l'appareil anti-recul fonctionnent, ils doivent être engagés dans la pièce. Le couteau diviseur et l'appareil anti-recul sont inefficaces lorsque l'on coupe des pièces trop courtes pour que le couteau diviseur et l'appareil antirecul puissent s'y engager. Dans ces conditions, le couteau diviseur et l'appareil anti-recul ne peuvent pas empêcher un recul de se produire.

Utiliser la lame appropriée au couteau diviseur. Pour que le couteau diviseur fonctionne correctement, le diamètre de la lame doit correspondre au couteau diviseur approprié, l'épaisseur de la lame de scie doit être plus mince que celle du couteau diviseur et la largeur de coupe de la lame de scie doit être supérieure à l'épaisseur du couteau diviseur.

Avertissements relatifs aux modes opératoires de coupe

DANGER: Ne jamais mettre les doigts ou les mains à proximité ou dans l'alignement de la lame. Votre main pourrait glisser ou se diriger vers la lame dans un moment d'inattention et entraîner une blessure grave.

Avancer la pièce en direction de la lame ou du couteau uniquement dans le sens inverse de rotation. L'avance de la pièce dans le même sens que le sens de rotation de la lame au-dessus de la table peut entraîner la pièce et la main dans la lame. Ne jamais utiliser le guide inclinable pour avancer la pièce lors d'un sciage en long et ne pas utiliser le guide longitudinal comme butée longitudinale lors d'un sciage en travers à l'aide du guide inclinable. Le guidage de la pièce en utilisant en même temps le guide longitudinal et le guide inclinable augmente le risque de blocage de la lame et de recul.

Lors d'un sciage en long, toujours appliquer la force d'alimentation de la pièce entre le guide et la lame. Utiliser un poussoir lorsque la distance entre le guide et la lame est inférieure à 150 mm et utiliser un bloc-poussoir lorsque cette distance est inférieure à 50 mm. Des appareils d'aide à l'utilisation maintiendront la main à une distance sans risque de la lame. Utiliser seulement le poussoir fourni par le fabricant ou construit conformément aux instructions. Ce poussoir permet de garder une distance suffisante entre la main et la lame.

Ne jamais utiliser un poussoir endommagé ou coupé. Un poussoir endommagé peut faire glisser votre main dans la lame. Ne jamais effectuer une opération "à main levée". Toujours utiliser le guide longitudinal ou le guide inclinable pour positionner et guider la pièce. "A main levée" signifie utiliser ses mains pour soutenir ou guider la pièce, au lieu d'un guide longitudinal ou inclinable. Une coupe à main levée entraîne un mauvais alignement, un blocage et un recul.

Ne jamais tendre le bras autour ou au-dessus de la lame rotative. Le fait d'étendre le bras pour atteindre une pièce peut entraîner un contact accidentel avec la lame rotative.

Prévoir un support supplémentaire de la pièce à l'arrière et/ou sur les côtés de la scie circulaire pour des pièces longues et/ou larges afin de les maintenir à plat. Une pièce longue et/ou large a tendance à pivoter sur le bord de la table, entraînant une perte de contrôle, un blocage de la lame et un recul.

Avancer la pièce à un rythme régulier. Ne pas plier ou tordre la pièce. En cas de coincement de la lame, arrêter l'outil immédiatement, le débrancher et décoincer la lame. Un coincement de la lame par la pièce peut provoquer un recul ou faire caler le moteur.

Ne pas enlever des morceaux de matériau coupé lors du fonctionnement de la lame. Le matériau peut être emprisonné entre le guide ou à l'intérieur du protecteur de lame et la lame, entraînant vos doigts dans la lame. Stopper le fonctionnement de la scie et attendre l'arrêt de la scie avant de retirer le matériau.

Utiliser un guide auxiliaire en contact avec le plateau de la table lors d'un sciage en long de pièces d'épaisseur inférieure à 2 mm. Une pièce mince peut se coincer sous le guide longitudinal et provoquer un recul.

Causes de recul et avertissements associés

Le recul est une réaction soudaine de la pièce due à une lame pincée, bloquée ou une ligne de coupe mal alignée dans la pièce par rapport à la position de la lame ou lorsqu'une partie de la pièce se bloque entre la lame et le guide longitudinal ou un autre objet fixe.

Le plus souvent lors d'un recul, la pièce est soulevée de la table par la partie arrière de la lame et est projetée en direction de l'opérateur.

Le recul résulte d'une mauvaise utilisation de la scie et/ou de modes opératoires ou de conditions de fonctionnement incorrects et peut être évité en prenant les précautions nécessaires telles qu'indiquées ci-dessous.

Ne jamais se tenir dans l'alignement direct de la lame. Toujours se tenir du même côté de la lame que le guide. Un recul peut propulser la pièce à une vitesse rapide vers quiconque se trouvant devant et dans l'alignement de la lame.

Ne jamais tendre le bras au-dessus ou à l'arrière de la lame pour retirer ou soutenir la pièce. Un contact accidentel avec la lame peut se produire ou un recul peut entraîner vos doigts dans la lame.

Ne jamais maintenir et presser la pièce contre la lame rotative. Presser la pièce contre la lame rotative provoquera un blocage de la lame et un recul.

Aligner le guide parallèlement à la lame. Un mauvais alignement du guide entraînera un pincement de la pièce contre la lame et un recul.

Utiliser un peigne anti-recul pour guider la pièce contre la table et le guide lors des coupes non traversantes tels que le refeuillement, l'engravure ou la refente. Un peigne anti-recul aide à contrôler la pièce en cas de recul.

User de précautions supplémentaires lors d'une coupe dans des zones non visibles de pièces assemblées. La partie de lame qui dépasse peut couper des objets qui peuvent provoquer un recul.

Soutenir les grands panneaux pour limiter le risque d'un blocage de la lame et d'un recul. Les grands panneaux ont tendance à s'affaisser sous leur propre poids. Un (des) support(s) doi(ven)t être placé(s) sous toutes les portions du panneau par-dessus la table.

User de précautions supplémentaires lors de la coupe d'une pièce torsadée, gauchie ou comportant des noeuds, qui n'a pas un bord droit pour le guider à l'aide d'un guide inclinable ou le long du guide. Une pièce torsadée, gauchie ou comportant des noeuds est instable et provoquer un mauvais alignement du trait de scie avec la lame, un blocage de la lame et un recul.

Ne jamais couper plusieurs pièces empilées verticalement ou horizontalement. La lame pourrait attraper plusieurs pièces et provoquer un recul.

Lors d'un redémarrage d'une scie avec une lame de scie dans la pièce, centrer la lame dans le trait de scie de sorte que les dents ne pénètrent pas dans le matériau. Si la lame se bloque, elle peut soulever la pièce et provoquer un recul lors du redémarrage de la scie.

Maintenir les lames propres, bien aiguisées et avec un écart latéral suffisant. Ne jamais utiliser des lames gauchies ou des lames dont les dents sont fissurées ou cassées. Des lames bien aiguisées et ayant un bon écart latéral limitent le risque de blocage, de calage et de recul.

Avertissements relatifs au mode opératoire de fonctionnement de la scie circulaire à table

Arrêter le fonctionnement de la scie circulaire et débrancher le cordon d'alimentation lors de l'enlèvement de la plaque amovible, du remplacement de la lame de scie ou des réglages du couteau diviseur, de l'appareil anti-recul ou du protecteur de lame, et lorsque la machine est laissée sans surveillance. Ces mesures de précaution éviteront les accidents.

Ne jamais laisser la scie circulaire à table fonctionner sans surveillance. Arrêter le fonctionnement et ne pas quitter l'outil tant qu'il n'a pas cessé de fonctionner. Une scie fonctionnant sans surveillance est un danger incontrôlé.

Placer la scie circulaire à table dans un endroit bien éclairé et sur une surface plane où elle peut être maintenue bien en appui et en équilibre. Il convient de l'installer dans un endroit qui prévoit une place suffisante pour pouvoir manipuler facilement la pièce quelle que soit sa taille. Des endroits exigus, sombres et des sols inégaux et glissants sont susceptibles de provoquer des accidents.

Nettoyer fréquemment et enlever la sciure accumulée sous la scie circulaire à table et/ou sous l'appareil de dépoussiérage. La sciure accumulée est combustible et peut s'enflammer.

La scie circulaire à table doit être immobilisée. Une scie circulaire à table mal immobilisée peut bouger ou basculer.

Enlever les outils, copeaux de bois, etc. de la table avant de faire fonctionner la scie. Un moment d'inattention ou un coincement éventuel peut être dangereux.

Toujours utiliser des lames de scie de dimensions et de forme appropriées des alésages centraux (lame de scie au diamant contre lame de scie ronde). Des lames qui ne sont pas conformes aux matériels de montage de la scie seront excentrées, provoquant une perte de contrôle.

Ne jamais utiliser des appareils de montage, tels que des flasques, des rondelles de lame, des boulons ou écrous, endommagés ou inadaptés. Ces appareils de montage ont été spécialement conçus pour être utilisés avec votre scie, à des fins de fonctionnement sûr et de performance optimale.

Ne jamais se tenir sur la scie circulaire à table, ne pas l'utiliser comme tabouret. Des blessures sérieuses peuvent survenir si l'outil bascule ou en cas de contact accidentel avec l'outil de coupe.

Veiller à ce que la scie circulaire à table soit installée de façon à tourner dans la bonne direction. Ne pas utiliser des meules, des brosses métalliques ou des disques abrasifs sur une scie circulaire à table. Une installation incorrecte de la lame ou l'utilisation d'accessoires non recommandés peut entraîner de graves blessures.

Setup



Expand any section above to view help sections created. If you are reading this manual or viewing an electronic PDF version, You may want to check out our interactive manual available here:

<https://lagunatools.com/classic/tablesaws/f3/manual>

All videos and sections will be current on this website.

Setup Overview (MUST READ)

When setting up your Fusion F3 Table saw, please take a moment to read this overview prior to starting.

1. Carefully un-box the saw.
2. Gather all loose parts and organize them first. Keep all hardware close to the installation location and be sure not to mix the hardware up after removing it from the packaging. A detailed [Inventory](#) ^[17] [list](#) section has been made to aid organization and simplify set up.
3. **Level the saw to the ground first.** If you begin to level the saw to a non level ground, everything will be off. Start from the ground up. The saw can easily be leveled to the floor with the integrated foot pads on the right side of the base.
4. After leveling the base to the foundation, begin to follow the [Front Rail](#) ^[24] Section.
5. After the Front Rail is attached, follow the [Rear Rail](#) ^[28] Section.
6. After both rails are installed begin to install the [Right Extension Table](#) ^[32], and then the [Rear Extension Table](#) ^[34]. Be sure to level all the rails and tables to the cabinet (which is level to the floor).
7. Once all the tables and rails are installed, finish setup by installing the [Front Rail and the Control Switch](#) ^[37].
8. Now that the Setup is complete, all that is left is to plug it in. **⚠️ WARNING!** Fusion table saws all have magnetic switches, but make certain the blade is tight and nothing is in the way of the blade prior to turning on the machine. **⚠️ WARNING!** Be sure wiring is correct according to local electric code. All needed electrical information can be found in the [Electrical Safety](#) ^[9] Section.

After Setup, there may be a few adjustments to be made. All of these adjustments are done prior to shipping the saw, but if one is found to need adjustment please follow the adjustment guides.











Inventory List





Your F3 Fusion table saw will likely be delivered by a third-party delivery service. Before unpacking your new machine, first inspect the packaging, the invoice, and the shipping documents supplied by the driver. When unpacking your table saw, separate all enclosed items from the packing materials and inspect them for damages. Ensure that there is no visible damage to either the packaging or the machine BEFORE the driver leaves. Save all packaging materials until you are satisfied with the machine and/or have resolved any issues concerning any missing or damaged items.

NOTICE! All shipping damage must be noted upon delivery and signed by the owner and the delivery driver. If you find any damaged items in your package, you must contact Laguna Tools to file a complaint. In order to return damaged goods under the limited warranty to Laguna Tools, Inc., you MUST have the original packaging. All claims of loss or damaged goods must be reported to Laguna Tools within 24 HOURS of delivery. Please contact the Laguna Tools, Inc. Customer Service Department to make claims for any damaged items/parts.

Loose Parts Inventory







The following depicts items shipped with your machine. Before assembling your saw, ensure that you have received all parts shown below. Machine parts should arrive sealed in plastic bags. Remove parts from plastic bags before laying them out to inventory them.



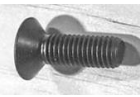

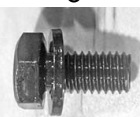

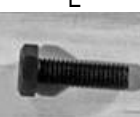
REF	Description	Q	PACKAGING
	F3 Table	1	Wooden Crate
	Right Extension Table	1	Boxed Individually
	Right Extension Legs	2	Boxed with Outboard Table
	Rear Extension Table	1	Boxed Individually
	Rear Extension Table Legs	2	Each leg Boxed individually
	Miter Gauge	1	Boxed Individually
	Dust Collection Hose	1	Plastic Wrapped Individually
	Blade Guard Assembly	1	Boxed Individually
	Fence Assembly	1	Boxed Individually
	Fence Lock Knob	1	Boxed w/ Fence Assembly
	Push Stick	1	Boxed w/ Fence Assembly

REF	Description	Q	PACKAGING
	Left Side Front Rail	1	Boxed w/ Fence Assembly
	Front Rail Assembly	1	Boxed Individually
	Rear Rail Assembly	1	Boxed with Steel Rail
	Control Switch	1	Attached to table
	Dust Collector Hose	1	Boxed Individually

Hardware Inventory

Listed below are all the hardware required for assembly of the Fusion F3 table saws. The hardware below has been included in the Fusion F3's packaging. As you inventory the other parts shipped with your machine, be sure to inventory and familiarize yourself with the hardware listed below.

Ref.	Description	Q	Installation
A 	Counter-Sunk Alan Head Screws (25mm) use with hex nuts(F), flat washers(H)	7	Front Rail Assembly, F3 Table Also used to fasten Right Extension Table
B 	Socket head Button Screw w/ Lock Washer (28mm) use with hex nuts(F), flat washers(H)	4	Rear Rail Assembly, F3 Table Dust collector hose support, F3 Table
C 	Hex Cap Screw w/ Flat Washer (longer)	5	Rear Extension Table, F3 Table Control Switch, Left Front Rail
D 	Socket Head Cap Screw (no washer) (28mm) use with use with hex nuts(F), lock washers (E)	5	Rear Rail Assembly, F3 Table
E 	Hex Cap Bolt (30mm) use with hex nuts(F), lock washers (E)	2	Left Side Front Rail Assembly, F3 Table
F 	Hex Nuts (13mm)	20	Multiple
G	Flat Washers (8mm)	17	Multiple

Ref.	Description	Q	Installation
			
<p>H</p> 	<p>Lock Washers (8mm)</p>	<p>8</p>	<p>Multiple</p>
<p>I</p> 	<p>Hex Cap Bolt (51mm) use with Nylon Lock Nuts(H)</p>	<p>4</p>	<p>Rear Extension Table Legs, Rear Extension table</p>
<p>J</p> 	<p>Nylon Lock Nuts (16mm)</p>	<p>4</p>	<p>Rear Extension Table Legs, Rear Extension table</p>
<p>K</p> 	<p>Rubber Feet</p>	<p>2</p>	<p>F3 Table (Bottom)</p>
<p>L</p> 	<p>Hex Cap Screw w/ Flat Washer (shorter)</p>	<p>9</p>	<p>Front Body to Front Rail (left & right side)</p>

Accessory Hardware & Tools

NOTICE! The hardware and tools listed below come individually wrapped in plastic bags.

General Tools: dual-sided wrench and Allen wrenches.



Band clamp with hex bolt, flat washer, and hex nut.



Fence hooks and hex bolts with flat washers.



Unboxing

Your Fusion F3 table saw was carefully packaged for safe transport. The table saw should arrive attached to a wooden pallet and covered by a wooden crate housing the table saw and its accessories. When unpacking your machine, separate all enclosed materials to ensure that there are no damages to the parts you've received. See pages 6-7 to cross reference the parts you should receive with your table saw.

⚠ DANGER Do not plug in the machine until setup is complete.
Always unplug the machine prior to any maintenance or setup work.

⚠ WARNING This machine is heavy. If you have any doubt about the following unboxing or set up procedures seek assistance from an experienced professional. **DO NOT** attempt any procedure that you feel is unsafe or that you feel you do not have the physical capability of achieving.

⚠ CAUTION Do not cut deep into the wooden crate with a blade as it may scratch the paint of the table saw. To prevent this, only use a dull edge or cut deep enough to only puncture the tape.

NOTICE Before setting up your machine, organize all additional set-up tools. The package will arrive fitted to a wooden pallet.

Quick Reference Guide	
	
Add. Required Tools: <ul style="list-style-type: none"> • Phillips head Screwdriver • Standard wrench • Shop Rag • WD40 (Cleaning solvent) 	
Troubleshooting/Tips: Use at least two people to lift the wooden crate covering the table saw and its accessories.	

Unboxing

- 1) Using a Phillips head screwdriver, remove the screws lining the bottom of the wooden crate. This will release the crate covering from the wooden pallet.

Fusion 3 Table Saw \ Setup \ Unboxing

Shipped Cartons w/52" Fence Rails

(Only 1 crate with 36" Fence Rails, inside)

Bolt Locations

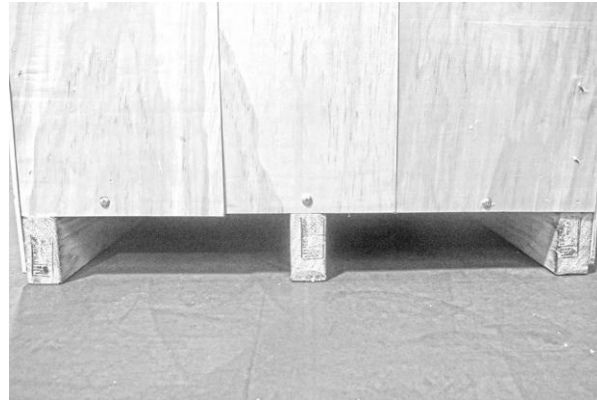

Screwing out skid bolts

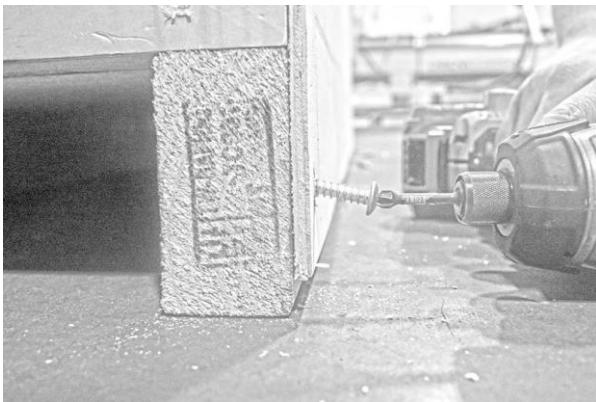

⚠ WARNING! You will need TWO OR MORE people to assist in completing step two.

- 2) With another person, lift the wooden crate off the wooden pallet. The table saw and individually boxed accessories will be located beneath.
- 3) Remove individually packaged items and inventory parts to ensure all parts have arrived undamaged.

Un-crated carton



Removing the table saw from the wooden pallet:

NOTICE! The table saw will arrive secured to the wooden pallet.

- 1) Using the 13mm socket wrench provided or a standard wrench, loosen the bolts attaching the table saw to the pallet's metal L brackets.

Bolt Removal



⚠ WARNING! It is recommended that TWO OR MORE people assist in completing step two. However, one person can complete the remaining unboxing steps without further assistance.

- 2) Preferably with another person, slowly walk the table saw off the wooden pallet.
- 3) For safe assembly, place the table saw in a well-lit, location free of any debris or obstructions.

Table Saw Mobility:

1. At the base of the table saw, there are two lock knobs (shown right) which allow the user to adjust the wheels located beneath the table saw. Tightening the knobs will lock the table saw's wheels. Loosen the knobs to allow wheels to move. After the knobs have been adjusted, lift the table saw from the opposite end (like a wheelbarrow).

Knob Location



Loosening Lock Knobs







Front Rail



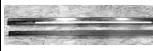

The Fusion F3 table saw's front rail assembly houses the front rail and guide ruler. In conjunction with the rear rail, the front rail allows the fence to move fluidly across the table. The front rail assembly is made up of the left and right front rail brackets, the front rail, and the control switch.

NOTICE! Make sure to level the saw to the foundation prior to leveling anything to the saw body. Please read the [Overview](#) ¹⁶¹ prior to doing anything.

Quick Reference Guide

<p>Add. Required Tools:</p> <ul style="list-style-type: none"> • Level • Allen Wrenches • General Wrench
<p>Troubleshooting/Tips:</p> <p>Attaching the rubber feet to the rear extension legs before attaching the legs to the front rail bracket will make for easier assembly.</p>

Parts			
REF	Description	Q	Installation
	Right Extension Legs	2	Front Rail Assembly
	Front Rail Assembly (Only the front rail bracket is needed)	1	F3 Table
	Left Side Front Rail	1	F3 Table Rail Body

Hardware			
REF	Description	Q	Installation
A 	Counter-Sunk Alan Head Screws (25mm) use with hex nuts(F), flat washers(H)	5 of 7	Front Rail Assembly, F3 Table Also used to fasten Right Extension Table
F 	Hex Nuts (13mm)	5 of 20	Front Rail Assembly, F3 Table
G	Flat Washers (8mm)	5 of 17	Front Rail Assembly, F3 Table

Hardware			
			
E 	Hex Cap Bolt (30mm) use with hex nuts(F), lock washers (E)	2 of 2	Left Side Front Rail Assembly, F3 Table
H 	Lock Washers (8mm)	2 of 8	Left Side Front Rail Assembly, F3 Table
K 	Rubber Feet	2 of 2	Right Extension Leg

Attaching the Rubber Feet to the Right Extension Legs:

1. Locate the threaded holes on the bottom of each of the right extension legs.
2. Thread each rubber foot through the right extension leg's bottom threaded holes.
3. Hand-tighten each foot to start. Later, the foot may need to be loosened or tightened in order to properly level the front and rear rails.

Correctly installed foot:



NOTICE! You may assemble both right extension legs at this step, though only one will be used to complete the following steps.

Attaching the Extension Legs to the Front Rail Bracket:

1. Align the right extension leg's bolt holes with the matching set of holes on the front rail bracket (located on the far right of the bracket).
2. Thread the counter-sunk bolts from the front rail through to the extension leg.
3. Thread a lock washer and hex nut to on the back of the counter-sunk bolt.
4. Secure the counter-sunk bolt to the front rail using an Allen wrench.

Front View

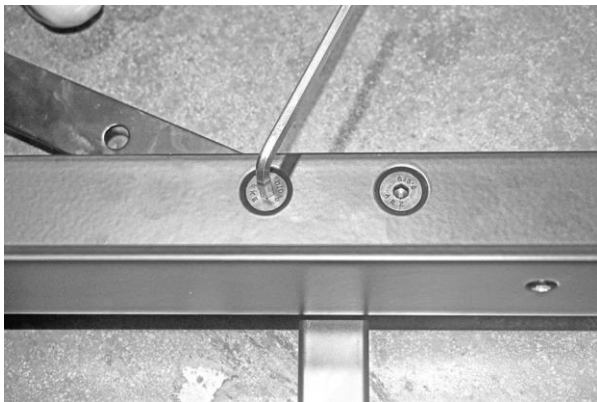

Rear View



Attaching the Right Front Rail to the Table:

1. Align the front bracket's through holes with the through holes on the front of the table.

NOTICE! The front rail bracket has three through-holes which should align with the last three through-holes on the front of the table located on the far right as shown.

2. Thread three counter-sunk screws through each of the front rail's through-holes.

3. Thread the flat washers and hex nuts onto the back of each counter-sunk bolt.

4. Use a level to ensure that the front rail is level to the table. If needed, you may adjust the height of the extension leg to level the bracket with the table.

5. After the bracket has been leveled, tighten the counter-sunk bolts with the wrench provided to secure the bracket to the table.

NOTICE! After completing step four, there should be two through holes in the middle of the front rail bracket which have not been used yet. These should be empty as they will be used to mount the right extension table later.

Three Front Rail Counter-Sunk Bolts

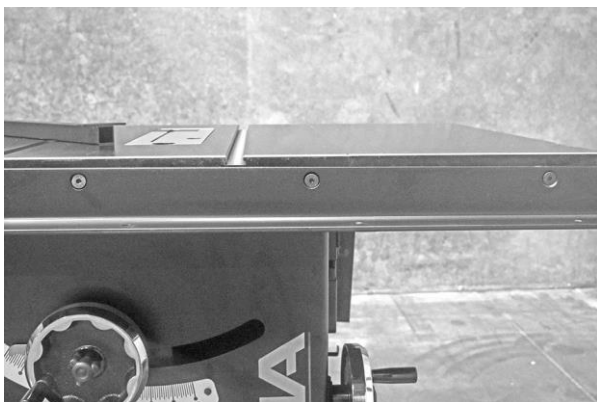

Flat Washer and Hex Nut (secured to the table)

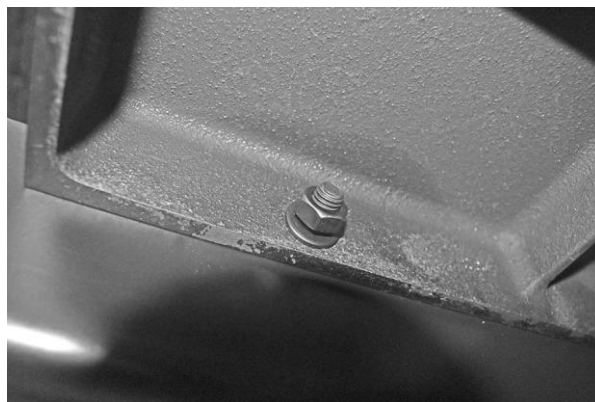

Middle counter-sunk through holes (empty):



Attaching the Left Front Rail to the Table:

1. Align the left front rail's bolt holes with the bolt holes on the front of the table saw.
- NOTICE!** These bolt holes will be located to the far left on the front of the table.
2. Place a lock washer onto the head side of the 30 mm hex bolts. Then thread two 30 mm hex bolts through each of the left front rail's bolt holes.
3. Thread a flat washer and hex nut onto the back of the 30 mm hex bolt.
4. Hand-tighten the bolts to secure the left front rail to the table. Then, use a level to ensure that the left front rail bracket is leveled.
5. After the left front rail bracket has been leveled, tighten the hex bolts using the wrench provided.

Left front rail and level

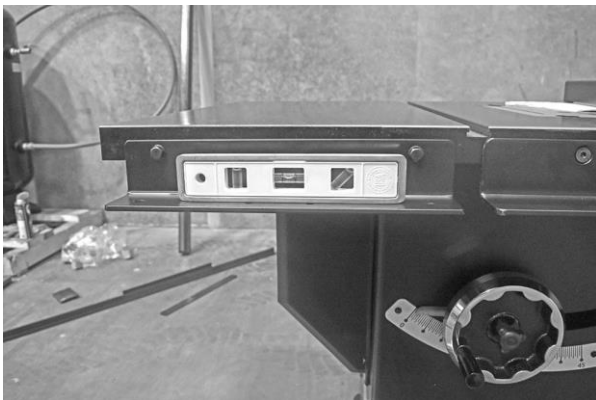





Flat Washer and Hex Nut (secured to the table)







Rear Rail

The Fusion F3 table saw's rear rail assembly supports both the fence and the rear extension table attachment. In conjunction with the front rail, the rear rail allows the fence to move fluidly across the table. The rear rail assembly is made up of the left and right rear rail bracket, the dust collector hose support bracket, the rear rail bracket.

Quick Reference Guide

<p>Add. Required Tools:</p> <ul style="list-style-type: none"> • Level • Allen Wrenches • General Wrench
<p>Troubleshooting/Tips:</p> <p>Attaching the dust collector hose support to the right rear rail bracket BEFORE attaching the right extension leg to the bracket will make for easier assembly.</p>

Parts			
REF	Description	Q	Installation
	Right Extension Legs (now assembled)	2	Assembled to F3 Table
	Rear Rail Assembly	1	F3 Table
	Dust Collector Hose	1	Right Rear Rail Bracket

Hardware			
REF	Description	Q	Installation
B 	Socket head Button Screw w/ Lock Washer (28mm) use with hex nuts(F), flat washers(H)	4 of 4	Rear Rail Assembly, F3 Table Dust collector hose support, F3 Table
D 	Socket Head Cap Screw (no washer) (28mm) use with hex nuts(F), flat washers(H), lock washers(H)	3 of 5	Rear Rail Assembly, F3 Table
F 	Hex Nuts (13mm)	7 of 20	Rear Rail Assembly, F3 Table
G	Flat Washers (8mm)	7 of 17	Rear Rail Assembly, F3 Table

Hardware			
			
H 	Lock Washers (8mm)	3 of 8	Rear Rail Assembly, F3 Table

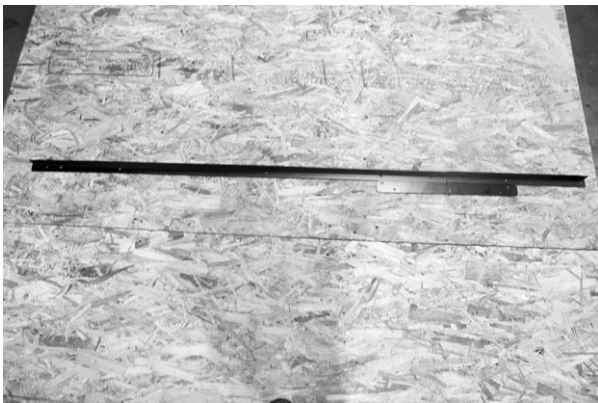
From left to right: Right Rear Rail Bracket, Left Rear Rail Bracket, Rear Rail Bracket (centered).



Attaching the Rear Extension Leg and Dust Collector Hose Support Bracket to the Right Rear Rail Bracket:

NOTICE! You will need to attach the dust collector hose support bracket to the right rear rail bracket, as they share an assembly bolt.

1. Align the right extension leg with the matching set of bolt holes at the end of the right rear rail bracket.
2. Using one socket head cap screw, secure the right extension leg to the rear right rail bracket. This will ensure that the leg does not move as the dust collector hose support is being attached to the rail and extension leg.
3. Align the dust collector hose support's bolt hole with the bolt hole farthest right on the right rear rail bracket. The dust collector hose should then also be aligned with the extension leg's furthest right bolt hole.
4. Secure the dust collector hose support, right rear rail bracket, and right extension leg to the table.

NOTICE! Thread lock washers to the head of the screws. Secure flat washers and hex nuts to the back of the screw.

Top View:

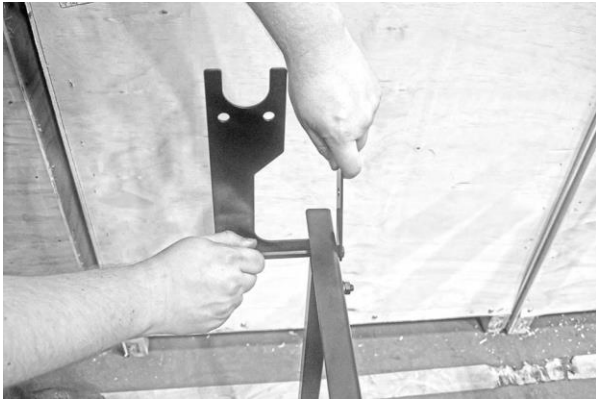

Front View:



Rear View:



Hose support and Leg properly Installed:



Attaching the Right Rear Rail Bracket to the Table:

1. Align the right rear rail bracket's bolt holes with the bolt holes located on the back of the table as shown below:

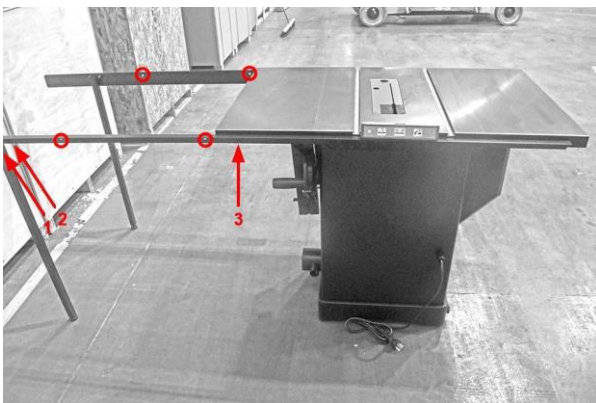

2. Thread 1 socket head cap screws and lock washer through the rear rail and table's through holes. **At this stage, only three socket head cap screws should be used to secure the rail to the table (see above image).**
3. Thread flat washer and hex nut and snugly tighten, allowing play.

NOTICE! After completing step two, there should be two through holes in the middle of the front rail bracket which have not been used yet. These should be empty as they will be used later to mount the right extension table (shown above as red circles)

Attaching the Left Rear Rail Bracket and Rear Bracket to the Table:

1. Align the left rear rail bracket's threaded bolt holes with the bolt holes located on the far left of the table saw.
2. Place the rear rail bracket over the right and left rear rail brackets. (pictured below).
3. Align the rear rail's bolt holes with the left and right rear rail's bolt holes as shown.
4. Thread socket head cap screws and lock washers through the rear rail assembly.
5. Thread flat washers and hex bolts on to the back of the socket head cap screws, make sure the rails are level to the table, and tighten to secure all brackets to the table.

NOTICE! Ensure that the **through holes** (not the threaded holes) on the rear rail brackets are used for this step. The threaded holes will be used later to attach the rear extension table to the table saw.

Leveling:

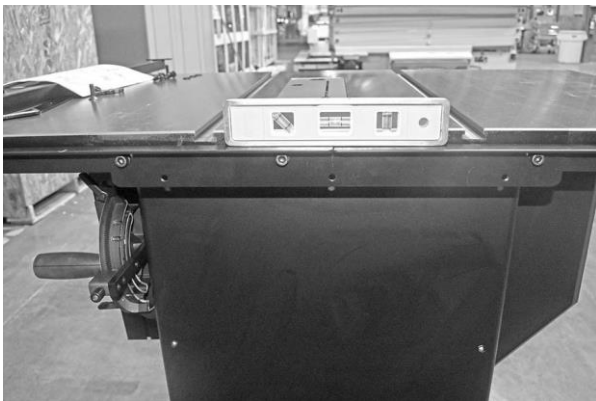



Bolt Tightening and arrangement: Bolt, lock washer // flat washer, nut







Right Extension Table

The Fusion F3 table saw's right extension table supports both the fence and the work piece. In conjunction with the front rail, the right extension table allows the fence to move fluidly across the table to adjust to the width of the wood piece being cut.

Quick Reference Guide

<p>Add. Required Tools:</p> <ul style="list-style-type: none"> • Level • Allen Wrenches • General Wrench
<p>Troubleshooting/Tips:</p> <p>Be sure that the right extension table's grooves are fitted snugly on the threads of the screws/bolts before securing the extension table to the rear rails.</p>

Parts			
REF	Description	Q	Installation
	Right Extension Table	1	Right Rear Rail, F3 Table, Right Front Rail

Hardware			
REF	Description	Q	Installation
A 	Counter-Sunk Alan Head Screws (25mm) use with hex nuts(F), flat washers(H)	2 of 7	Front Rail Assembly, F3 Table, Right Extension Table
D 	Socket Head Cap Screw (no washer) (28mm) use with hex nuts(F), flat washers(H), lock washers(H)	2 of 5	Rear Rail Assembly, F3 Table, Right Extension Table
F 	Hex Nuts (13mm)	4 of 20	Multiple
G 	Flat Washers (8mm)	4 of 17	Multiple
H	Lock Washers (8mm)	2 of 8	Socket Head Cap Screw

Hardware			
			

Mounting the Table Extension:

1. Thread two counter sunk bolts through the two available through holes on the front rail bracket.
2. Thread two socket head cap screws through the available bolt holes on the right ear rail bracket.
3. Place the right extension table's grooves on top of the socket head and counter-sunk screws respectively. Ensure that each of the four the grooves are securely rested on the threads of each of the exposed screws.
4. Thread flat washers and hex nuts on the backs of each of the screws. Use the wrench to tighten the bolts and secure the extension table to the front and rear rails.

Pre-Installation:



Underside Bracket (the picture does not show a flat washer used, please use one)

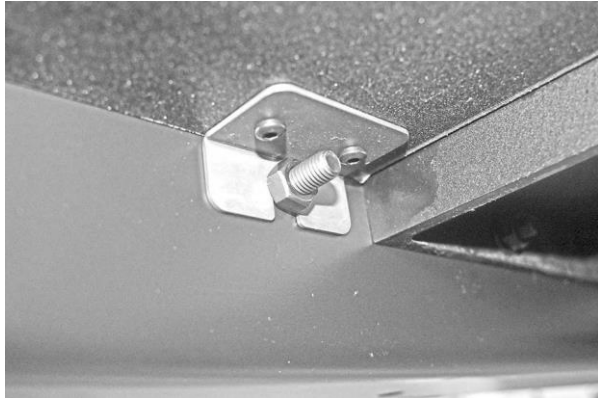



Completed installation:



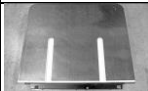

Rear Extension Table

The Fusion F3 table saw's rear extension table supports both the fence and the work piece. In conjunction with the rear rail, the rear extension table provides an extra support table for the length of the wood piece being cut.

Quick Reference Guide

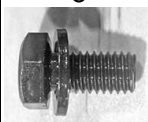
Add. Required Tools: <ul style="list-style-type: none"> • Level • General Wrench • 17mm socket wrench (optional)
Troubleshooting/Tips: For easiest assembly, flip the rear extension table so that the face is down. After the table has been flipped, attach the rear extension legs to the table.

Parts			
REF	Description	Q	Installation
	Rear Extension Table	1	Rear Rail Assembly, F3 Table
	Rear Extension Table Legs	2	Rear Extension Table

Hardware			
REF	Description	Q	Installation
C 	Hex Cap Screw w/ Flat Washer (longer)	3 of 5	Rear Extension Table, F3 Table
I 	Hex Cap Bolt (51mm) use with Nylon Lock Nuts(H)	4 of 4	Rear Extension Table Legs, Rear Extension table
J 	Nylon Lock Nuts (16mm)	4 of 4	Rear Extension Table Legs, Rear Extension table

Attaching Legs to the Rear Extension Table:

1. Flip the rear extension table so that the face is down.
2. Place the rear extension legs between the metal L-brackets on either side of the table.
3. Align the rear extension leg's bolt holes with bracket's bolt holes. Ensure that the rear extension leg's bolt holes are aligned with the last two bolt holes of the metal bracket.

4. Thread the 51 mm hex bolts through the metal L-bracket.
5. Thread nylon lock nuts on to the back of the hex bolts. Tighten with a wrench or a 17 mm socket wrench (optional).

Attaching legs to table:



Securing Bolts

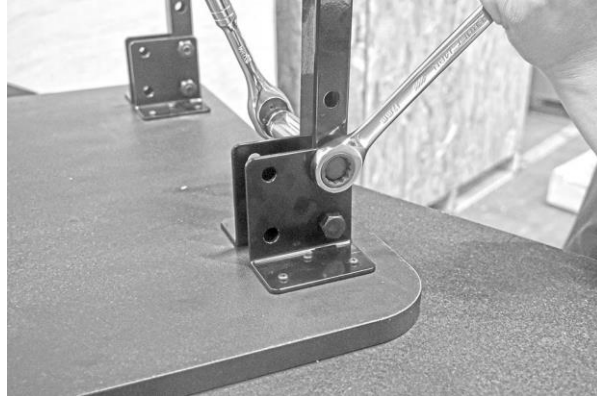

Installed Legs



Attaching the Rear Extension Table to the Table Saw:

1. Locate the three through holes on the back mounting bracket of the rear extension table.
2. Align these three through holes with the three threaded holes on the rear support bracket.
3. Thread one of the three (longer) Hex Bolt with Flat Washer through each of the threaded holes.

NOTICE! The height of the rear extension table's legs can be adjusted as needed to level the table.

Pre-installation



Aligning the bracket

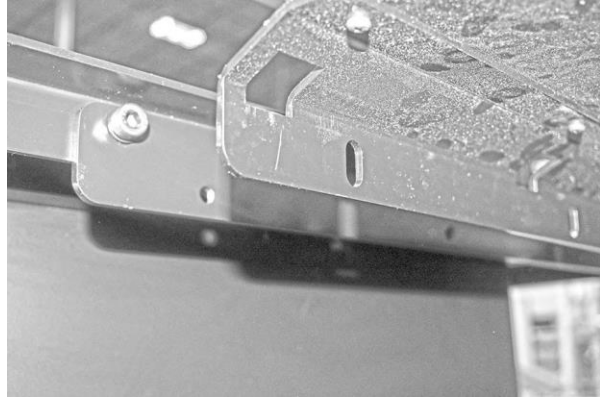





Bolt into thread holes:





Front Rail Pt. 2 & Control Switch

The Fusion F3 table saw’s front rail houses the control switch and front rail/guide ruler. The control switch allows the user to quickly turn the machine on/off before and after making cuts. The front rail assembly provides the user with a guide to measure the distance between the fence and the blade.

Quick Reference Guide

<p>Add. Required Tools:</p> <ul style="list-style-type: none"> • Level • General Wrench • 13mm socket wrench (optional)
<p>Troubleshooting/Tips:</p> <p>Be sure to attach the control switch to the left front rail from underneath the front left rail bracket. This will allow the left front rail block to fit properly on the left front rail bracket.</p>

Parts			
REF	Description	Q	Installation
	Front Rail Assembly (Rails previously assembly, body is needed)	1	Body mounted to rail
	Left Side Front Body (Rails previously assembly, body is needed)	1	F3 Table Rail Body
	Control Switch	1	Bolts onto Left side Rail

Hardware			
REF	Description	Q	Installation
C 	Hex Cap Screw w/ Flat Washer (longer)	2 of 5	Control Switch, Left Front Rail
L 	Hex Cap Screw w/ Flat Washer (shorter)	9 of 9	Front Body to Front Rail (left & right side)

Mounting the Control Switch to the Left Front Rail:

1. Align the bolt holes on the top of the control switch with the bolt holes on the bottom of the left front rail bracket.

2. Thread the 2 longer hex cap screw and flat washer through the control switch's bolt holes.
3. Tighten the bolts using either the general wrench or a 13 mm socket wrench to secure the control switch to the left front rail bracket.

NOTICE! Ensure that the head of the hex bolts are threaded from underneath the left front rail. The ends of each the bolts should be visible from the top of the left front rail.

Pre-Installation:



Control Switch Placement:



Mounting Control Switch with 2 longer hex bolts and flat washers



Control Switch correctly mounted. The expose bolts will fit the through holes in the fence body



Mounting the Left Front Rail Block to the Left Front Rail:

1. Place the left front rail block on the left front rail bracket.
2. Align the block's outermost through holes with the bracket's outermost through holes.
3. Like mounting the control switch, thread the shorter hex bolts with flat washers from underneath the left front rail bracket.
4. Using either the general wrench or a socket wrench, tighten the bolts to secure the left front rail block to the left front rail bracket.

Pre-Installation

Attaching the left front rail body to the left front rail using the shorter hex bolts and flat washers.



Mounting the Front Rail (with Guide Ruler):

1. Place the front rail on the front rail bracket.
2. Align the front rail's bolt holes (located on the bottom of the front rail) with the front rail's bolt holes.
3. Thread shorter hex bolts with flat washer through each of the front rail's bolt holes. **NOTICE!** Only hand-tighten the bolts for now.
4. Pull the rail out as far as it will allow first. This will allow space for the fence's nylon slider to move through comfortably.
5. Tighten each bolt using either the general wrench or a 13 mm socket wrench.

Front guide rail seated on front rail:

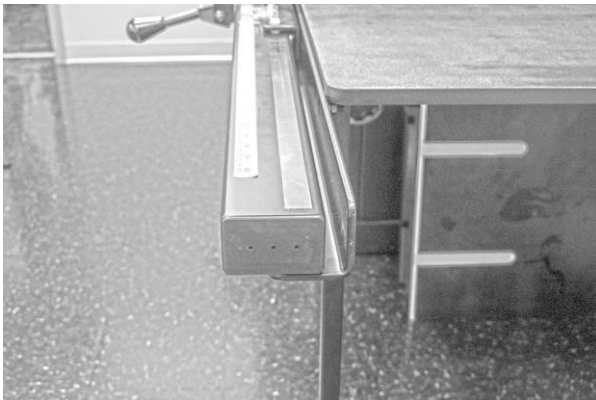

Underside View



Fitting the Fence to the Table:

NOTICE! The table saw's fence comes pre-assembled and will need no further assembly to put the unit together.

1. Place the fence's nylon sliders on the grooves between the front and back rails.
2. Ensure that the fence's locking gauge is placed over the edge of the front rail.

Fence fitted over the front guide rail



Detailed view



Front of rail showing counter sunk screws



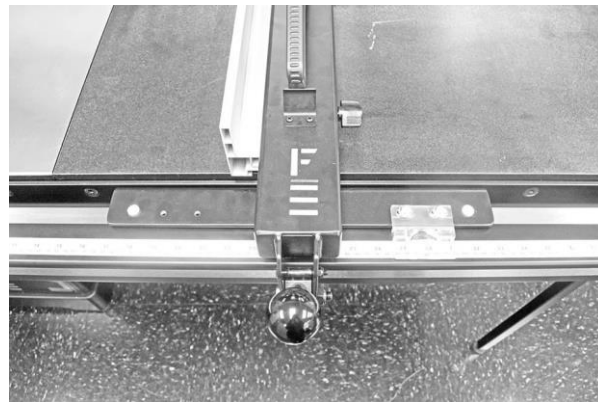

Properly Installed Fence:



Accessory Installation

The Fusion F3 table saw's supports several accessories which help the machine to run smoothly and function properly. The accessories which come with your table saw are: a dust collector hose, a set of fence hooks, and a tool caddy (located underneath the table).

Quick Reference Guide

<p>Add. Required Tools:</p> <ul style="list-style-type: none"> None
<p>Troubleshooting/Tips:</p> <p>The writhing knife can be found already attached to the blade upon arrival. Be sure the machine is off, when you attempt to remove the writing knife from its position on the back of the blade.</p>

Parts			
REF	Description	Q	Installation
	Blade Guard Assembly	1	Boxed Individually
	Dust Collection Hose	1	Blade-guard to Inlet

You will also need all the contents in the packages of:

Band clamp with hex bolt, flat washer, and hex nut.

Fence hooks and hex bolts with flat washers.



Attaching the Dust Collector Hose:

1. Attach a band clamp on the mouth of the dust collector hose.
2. Attach the hose to the dust port on the blade guard.
3. Tighten the band clamp to secure the hose to the blade guard.
4. Repeat steps one through three to attach the hose to the table saw's 4" dust outlet.

Attaching hose to blade guard assembly:



Attaching hose to dust port:

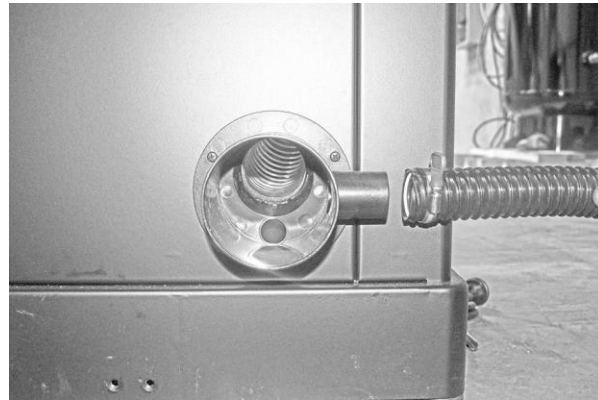

Attaching the Fence Hooks to the Table:

1. Locate the fence hook bolt holes on the back of the table saw (located underneath the rear extension table).
2. Thread the fence hook's hex bolts through the fence hook's bolt holes.
3. Thread the hex bolts through the bolt holes on the back of the table saw.
4. Tighten the hex bolts with the general wrench.

Fence Hook Installation



Fence Hook Installation



Tool Caddy:

The table saw's tool caddy is located under the right extension table. The tool caddy provides a space to store the miter gauge, the writing knife, and the blade wrench, and the general wrench when not in use. See the picture shown below to see proper placement of these tools.

From Top Down: A. Arbor Wrench, B. Miter Gauge, C. Riving Knife, D. Blade Guard Hook, E. Dust Hose Wrapping Hook.

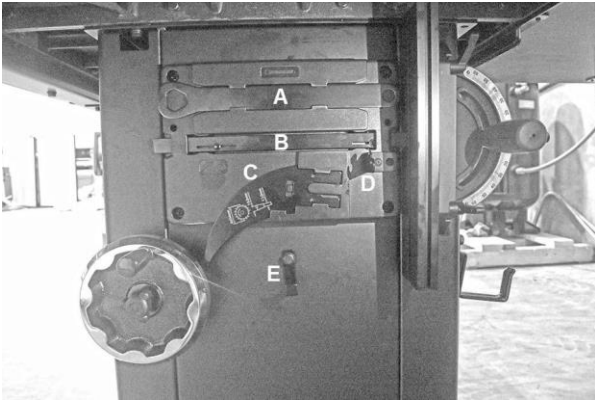

Your F3 Table Saw is now properly assembled.

Adjustments

Calibrating and adjusting the Tilt mechanism

MAINTENANCE & ADJUSTMENTS

ADJUSTING THE 45° & 90° BEVEL STOPS

1. Disconnect the machine from the power source.
2. Raise the blade to its highest position and lift the blade guard.
3. Loosen the bevel lock knob and turn the blade tilting handwheel clockwise until it stops.
4. Verify the angle of the blade with a combination square from the left side of the blade, keep the square flat against the table and against the flat part of the blade. Do not touch the teeth or the table insert.

If the blade 90° angle is incorrect, remove the motor cover G Fig. A by Philips screwdriver then loosen the Hex. Nut C, Fig. B then turn the 90° stop screw D, Fig. B under the table by Hex. wrench. Turn the hand wheel until the blade is at 90° to the table surface. Then re-tighten the 90° stop screw & Hex. nut until slight resistance is felt. Do not over tighten stop screw.

Verify the 45° setting by tilting the blade as far as possible to the left and using the square, check the angle and if needed adjust as for the 90° stop, this time remove the storage box H, Fig. C by Philips screwdriver then loosen the Hex. Nut E, Fig. C then turn the 45° stop screw F, Fig. C under the table by Hex. wrench. Turn the hand wheel until the blade is at 45° to the table surface. Then re-tighten the 45° stop screw & Hex. nut until slight resistance is felt. Do not over tighten stop screw.



WARNING: MAKE SURE THE SAW HAS BEEN TURNED OFF AND UNPLUGGED FROM THE POWER SOURCE BEFORE PERFORMING ANY MAINTENANCE.

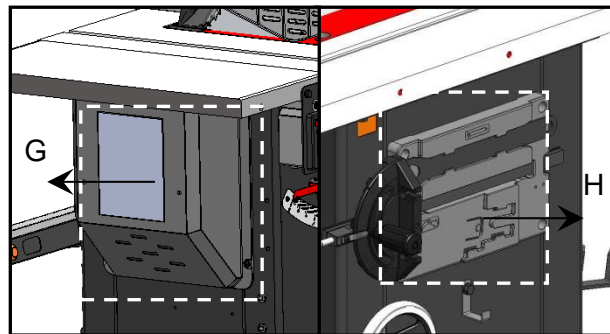

Fig. A

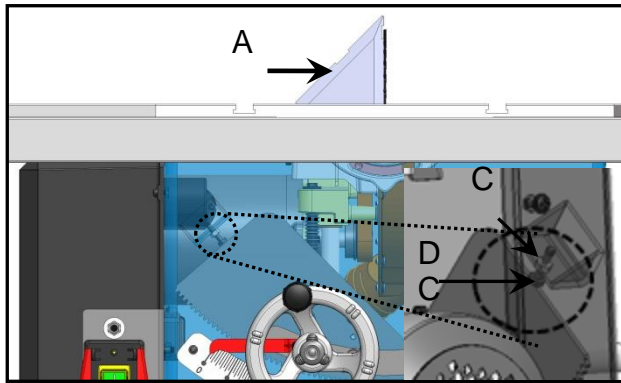

Fig. B

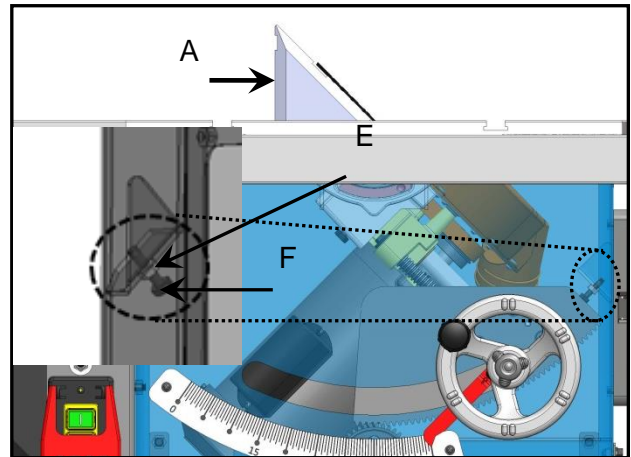

Fig. C

BLADE TILT /BEVEL ADJUSTMENT

The blade tilt (bevel) adjustment control by worm gear box assembly C, handwheel D is located on the side of the saw, Figs. D & E.

Turn the handwheel C left or right as required to set the blade to the desired angle. The blade can be tilted to the left anywhere from 0° (90° to the table) to 45°.

! WARNING: TO LIMIT YOUR EXPOSURE TO THE BLADE AND ALSO TO MAXIMISE THE EFFECTIVENESS OF THE ANTI-KICKBACK PAWLS (WHEN USING THE RIVING STYLE SPLITTER & BLADE GUARD), NEVER TAKE MORE BLADE HEIGHT THAN IS REQUIRED TO COMPLETE THE CUT. WHEN SETTING THE BLADE HEIGHT FOR THROUGH-CUTS (CUTS ALL THE WAY THROUGH THE THICKNESS OF A BOARD) SET THE HEIGHT OF THE BLADE TO ROUGHLY 1/4" HIGHER THAN THE THICKNESS OF THE BOARD.

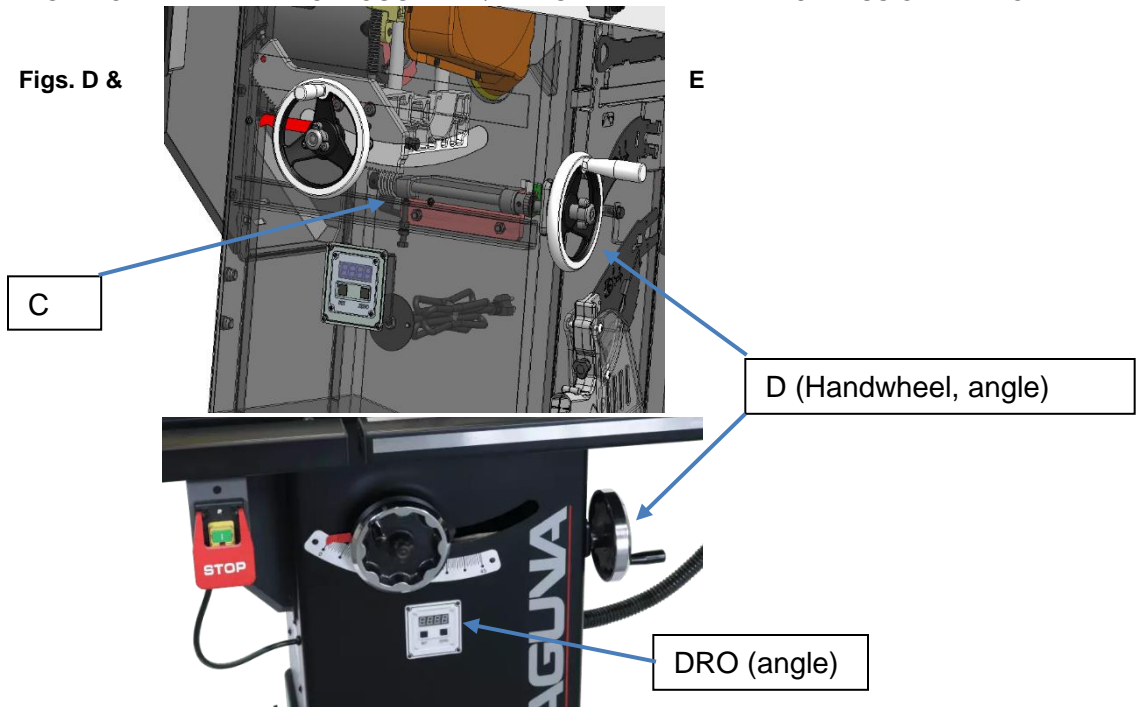

ALIGNING TABLE PARALLEL TO BLADE

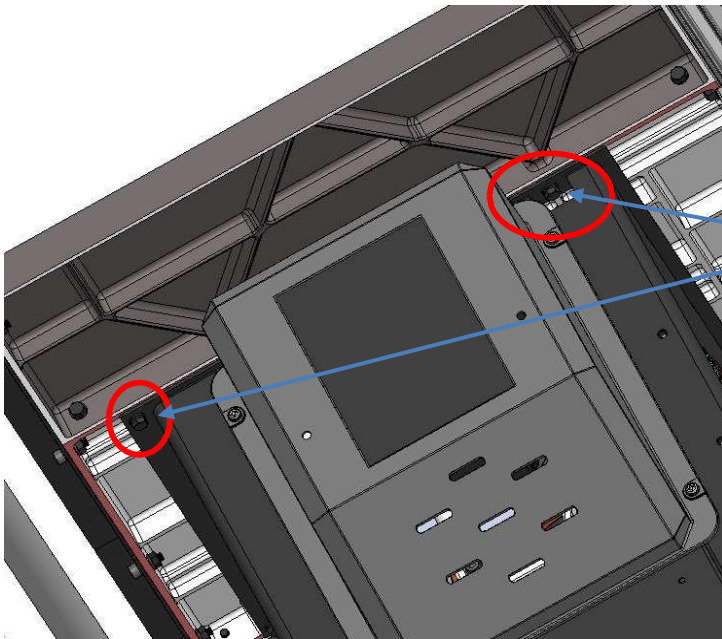

Fig. F

STEP 1: Loosen 4 bolts as shown.

STEP 2: Adjust table parallel to T-Slot (miter slot), by pivoting table. Use a ruler to measure from blade to T-Slot at the front and rear of blade.

STEP 3: Tighten 4 bolts as shown.

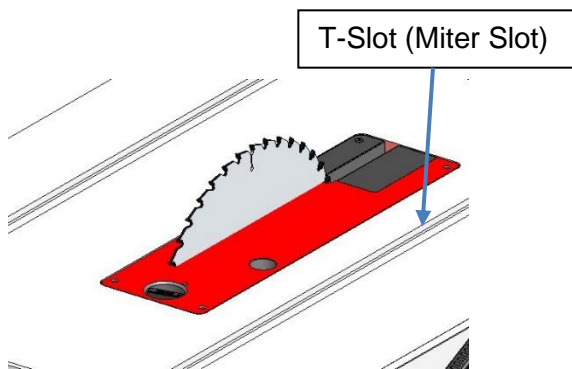

Fig. G

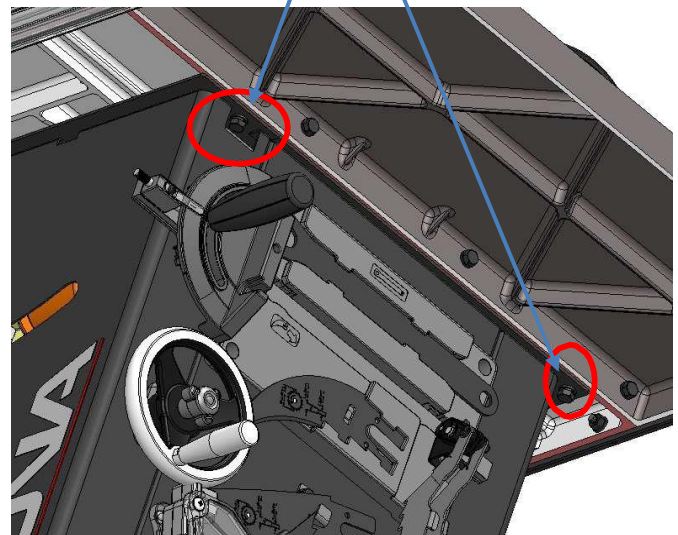
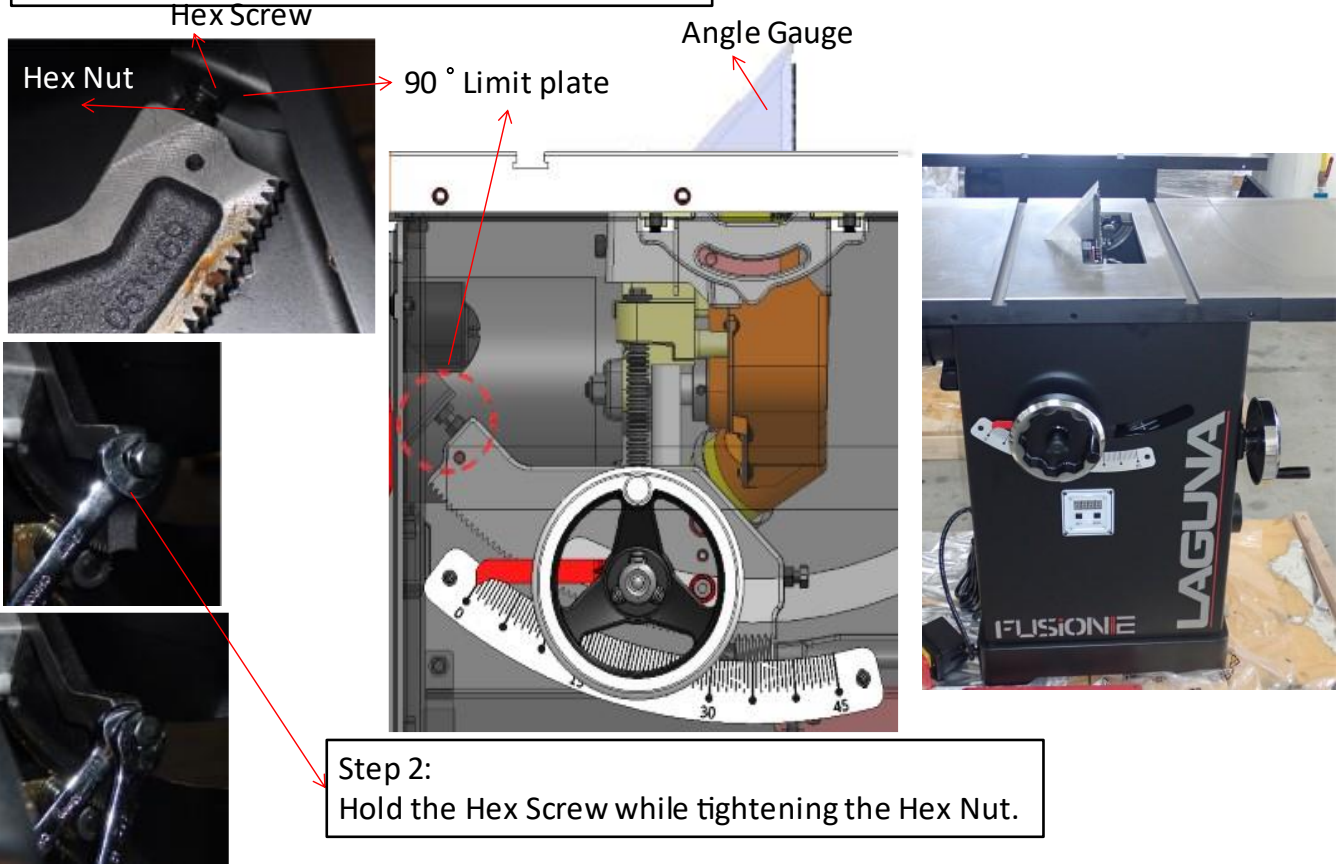

Fig. H

ADJUSTING 90° STOP

Step 1:
Adjust blade to 90°.
Adjust left side Hex Screw to contact Limit Plate.



ADJUSTING 45° STOP

Step 1:
Adjust blade to 45 °.
Adjust right side Hex Screw to contact Limit Plate.

Angle Gauge

45 ° Limit plate

Hex Screw

Hex Nut

Step 2:
Holt the Hex Screw while tightening Hex Nut.

Maintenance

	⚠ DANGER
	Unplug Machine prior to any maintenance work. Always unplug the machine when changing the blade, guards, or any maintenance.

General

Keep your machine clean. At the end of each day, clean the machine. Wood contains moisture, and if sawdust or wood chips are not removed, they will cause rust. In general, we recommend that you only use a Teflon-based lubricant on the saw. Regular oil attracts dust and dirt. Teflon lubricant tends to dry and has less of a tendency to accumulate dirt and saw dust. Periodically check that all nuts and bolts are tight.

Drive belt

The drive belt should last for many years (depending on the usage) but needs to be inspected regularly for cracks, cuts and general wear. If damage is found, replace the belt.

Bearings

All bearings are sealed for life and do not require any maintenance. If a bearing becomes faulty, replace it.

Rust

The saw is made from steel and cast iron. All non-painted surfaces will rust if not protected. It is recommended that they be protected by applying wax or a Teflon-based lubricant to them.

Daily Check:

- Loose mounting bolts
- Damaged saw blade
- Damaged riving knives, splitters, or blade guards
- Worn or damaged wires
- Any other unsafe condition

Monthly Maintenance:

- Clean/vacuum dust buildup from inside cabinet and off motors.
- Check/replace belt for proper tension, damage or wear

Weekly Maintenance:

- Clean table surface and miter slot grooves
- Clean and protect cast iron table
- Clean rip fence

Every 6-12 Months:

- Lubricate trunnion slides.
- Lubricate worm gear.
- Lubricate leadscrew.
- Lubricate gearing and gearboxes.

DRO POWER CONNECTION TEST/CHECK

If DRO does not power up or is inconsistent, please check the following:

DRO power connection check

- Turn off power and unplug table saw, then remove DRO display cover,

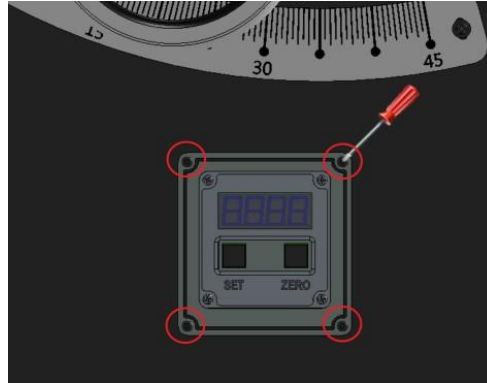

DRO power connection check

- Pull out the circuit board, check the black and white cords connection.
- If multi-meter is available, please replug table saw, and check voltage between black and white cords.

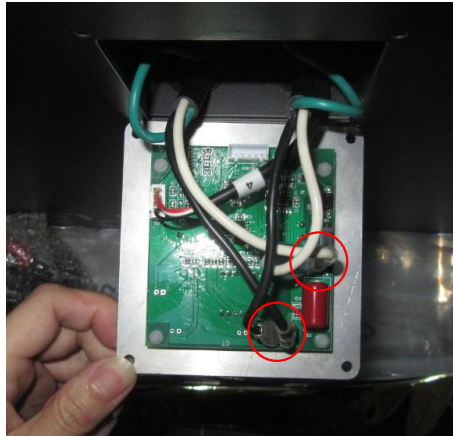

DRO power connection check

- If circuit board is check'S OK, please check contactor box.
- Contactor box is inside the cabinet, remove the cover

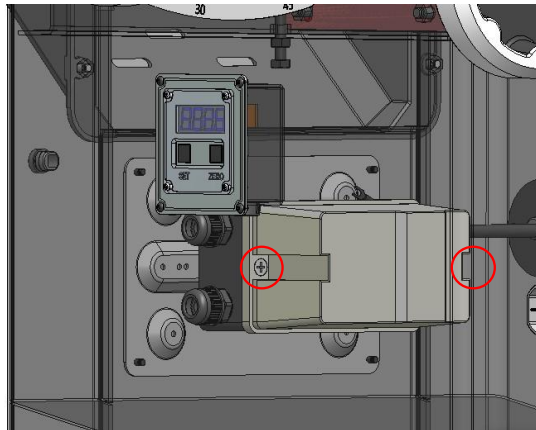

DRO power connection check

- Check L1 & L3 connection.

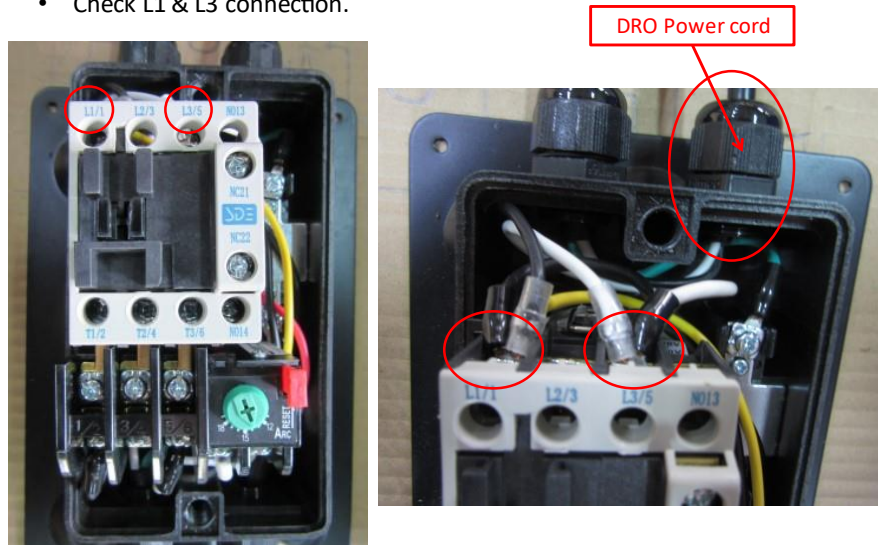

Troubleshooting

Behavior	Possible Causes	Solutions
Machine will not start or continues to trip the breaker.	<ol style="list-style-type: none"> 1. Start capacitor at fault. 2. Motor connection wired wrong. 3. Wiring at fault. 4. Motor Start/Stop switch at fault. 5. Motor at fault. 6. Run capacitor at fault. 7. Wall circuit breaker tripped or at fault. 8. Power supply switched OFF or at fault. 9. Plug/receptacle at fault or wired incorrectly. 	<ol style="list-style-type: none"> 1. Test/replace if faulty. 2. Correct motor wiring connections. 3. Check/fix broken, disconnected, or corroded wires. 4. Replace switch. 5. Test/repair/replace. 6. Test/replace if faulty. 7. Ensure circuit size is correct/replace weak breaker. 8. Ensure power supply is on/has correct voltage. 9. Test wires and contacts; correct the wiring.
Machine is excessively loud or is experiencing excessive vibration.	<ol style="list-style-type: none"> 1. Motor or component loose. 2. Blade at fault. 3. Motor mount loose/broken. 4. Machine incorrectly mounted. 5. Arbor pulley loose. 6. Belts worn or loose. 7. Pulley loose or at fault. 8. Arbor bearings at fault. 	<ol style="list-style-type: none"> 1. Inspect/replace damaged bolts/nuts, and re tighten with thread-locking fluid. 2. Replace warped/bent blade; re-sharpen dull blade. 3. Tighten/replace. 4. Tighten mounting bolts; relocate/shim machine. 5. Re-tighten/replace arbor pulley. 6. Adjust tension of/replace belt. 7. Realign/replace shaft, pulley, setscrew, and key. 8a. Replace arbor housing bearings; replace arbor. 8b. Test by rotating shaft; grinding/loose shaft requires bearing replacement.
Machine trips the overload, or feels underpowered during operation.	<ol style="list-style-type: none"> 1. Feed rate/cutting speed too fast. 2. Workpiece material unsuitable for machine. 3. Pulley/sprocket slipping on shaft. 4. Motor bearings at fault. 5. Contactor (internal breaker) at fault. 6. Motor overheated. 7. Workpiece crooked; fence not aligned. 8. Machine undersized for task; wrong blade. 9. Run capacitor at fault. 10. Belt is slipping from pulley. 11. Motor wired incorrectly. 12. Plug/receptacle at fault. 13. Motor at fault. 	<ol style="list-style-type: none"> 1. Decrease feed rate/cutting speed. 2. Only cut wood; ensure moisture is below 20%. 3. Test for good contacts/correct wiring. 4. Replace loose pulley/shaft. 5. Test/repair/replace. 6. Test all legs for power/replace if faulty. 7. Clean motor, let cool, and reduce workload. 8. Straighten or replace workpiece; adjust fence. 9. Use correct blade; reduce feed rate or depth of cut. 10. Test/repair/replace. 11. Adjust tension of/replace belt. 12. Wire motor correctly. 13. Test/repair/replace.
Dust Collection	<ol style="list-style-type: none"> 1. Inadequate suction 2. No suction 	<ol style="list-style-type: none"> 1. Check Dust Collection Unit and hose fittings. 2. move motor cover and verify that the internal hose is fixed to the blade shroud port and the external 4" port.

Specifications

	FUSION F1	FUSION F2	FUSION F3	FUSION F3 52
Maximum Blade Diameter	10" (254 mm)	10" (254 mm)	10" (254 mm)	10" (254 mm)
Max Rip Right of Blade w/Included Fence & Rails	30" (762mm)	36" (914 mm)	36" (914 mm)	52" (1320 mm)
Fence Type	Camlock T-Shape w/Aluminum Face	Camlock T-Shape w/European Hi-Lo Face	Camlock T-Shape w/European Hi-Lo Face	Camlock T-Shape w/European Hi-Lo Face
Table	Precision-Ground Cast Iron	Precision-Ground Cast Iron	Precision-Ground Cast Iron	Precision-Ground Cast Iron
Wings	Pre-Formed Steel	Precision-Ground Cast Iron	Precision-Ground Cast Iron	Precision-Ground Cast Iron
Cabinet	Pre-Formed Steel	Pre-Formed Steel	14 Ga. Steel	14 Ga. Steel
Trunnions	Cast Alloy	Cast Alloy	Cast Iron	Cast Iron
Dust Port Size	4" (101 mm)	4" (101 mm)	4" (101 mm)	4" (101 mm)
Blade Guard Dust Port Size	1-1/2" (38 mm)	1-1/2" in. (38 mm)	1-1/2" (38 mm)	1-1/2" (38 mm)
Weight, Gross	214 lbs. (97 Kg)	359 lbs. (163 Kg)	496 lbs. (225 Kg)	523 lbs. (237 Kg)
Weight, Net	195 lbs. (88.5 Kg)	276 lbs. (124.6 Kg)	396.8 lbs. (180 Kg)	422 lbs. (191 Kg)
Overall Width (side-to-side)	59.5" (1513 mm)	66-7/8"(1699 mm)	69" (1753 mm)	85" (2159 mm)
Overall Depth (front-to-back)	39-3/4" (1009 mm)	39-3/8" (1000 mm)	56" (1425 mm)	56" (1425 mm)
Overall Height	46" (1168 mm)	47" (1193 mm)	47" (1193 mm)	47" (1193 mm)
Power Requirement	110V/230V, Single-Phase, 60 Hz (wired 110V)	110V/220V, Single-Phase, 60 Hz (wired 110V)	220V, Single-Phase, 60 Hz	220V, Single-Phase, 60 Hz
Horsepower	1.5HP	1.75HP	3HP	3HP
Country of Origin	Taiwan	Taiwan	Taiwan	Taiwan
Certified by a Nationally Recognized Testing Laboratory (NRTL)	Yes	Yes	Yes	Yes

	FUSION F1	FUSION F2	FUSION F3	FUSION F3 52
Features				
	Fusion Hi-Lo Dust Collection	Full Cabinet Body	Industrial 14 Gauge (2mm) Cabinet	52" Rip Capacity
	Fusion Over-Under Trunnions	Cabinet Mounted Arbor	Accessory Tables (Outfeed & Rip)	Industrial 14 Gauge (2mm) Cabinet
	Polished Cast Iron Table	Cast Iron Table & Wings	Industrial Fence Rail	Accessory Tables (Outfeed & Rip)
	Reset Switch	European Hi-Lo Fence	Industrial Fusion Fence	Industrial Fence Rail
	Quick-Release Blade Guard and Spreader	Premium Zero Clearance Throat Plate	Premium Electrical & Hardware Components	Industrial Fusion Fence
	Riving Knife Included	Fusion Hi-Lo Dust Collection	Premium Miter Gauge	Premium Electrical & Hardware Components
	Push Stick included	Fusion Over-Under Trunnions	Cast Iron Fusion Trunnions	Premium Miter Gauge
	Miter Gauge Included	Reset Switch	Cabinet Mounted Arbor	Cast Iron Fusion Trunnions

	Blade Changing Tool Included	Quick-Release Blade Guard and Spreader	Cast Iron Table & Wings	Cabinet Mounted Arbor
	Integrated Tool Storage	Riving Knife Included	European Hi-Lo Fence	Cast Iron Table & Wings
	Premium Handles	Push Stick included	Premium Zero Clearance Throat Plate	European Hi-Lo Fence
	Included 10 x 60T Carbide-Tipped Blade	Miter Gauge Included	Fusion Hi-Lo Dust Collection	Premium Zero Clearance Throat Plate
	Premium Arbor and Motor Bearings	Blade Changing Tool Included	Magnetic Contactor Switch	Fusion Hi-Lo Dust Collection
		Integrated Tool Storage	Quick-Release Blade Guard and Spreader	Magnetic Contactor Switch
		Premium Handles	Riving Knife Included	Quick-Release Blade Guard and Spreader
		Included 10 x 60T Carbide-Tipped Blade	Push Stick included	Riving Knife Included
		Premium Arbor and Motor Bearings	Miter Gauge Included	Push Stick included
			Blade Changing Tool Included	Miter Gauge Included
			Integrated Tool Storage	Blade Changing Tool Included
			Included 10 x 60T Carbide-Tipped Blade	Integrated Tool Storage
			Premium Arbor and Motor Bearings	Included 10 x 60T Carbide-Tipped Blade
				Premium Arbor and Motor Bearings

	FUSION F1	FUSION F2	FUSION F3	FUSION F3 52
Main Information				
Table Saw Type	Hybrid Cabinet	Cabinet	Cabinet	Cabinet
Maximum Blade Diameter	10 in. (254 mm)	10 in. (254 mm)	10 in. (254 mm)	10 in. (254 mm)
Arbor Size	5/8" (15.87 mm)	5/8" (15.87 mm)	5/8" (15.87 mm)	5/8" (15.87 mm)
Arbor Speed	4000 RPM	4500 RPM	4500 RPM	4500 RPM
Maximum Width of Dado	3/4" (19.05 mm)	3/4" (19.05 mm)	3/4" (19.05 mm)	3/4" (19.05 mm)
Blade Tilt Direction	Left	Left	Left	Left
Max Blade Tilt	45 deg.	45 Degrees	45 Degrees	45 Degrees
Maximum Depth of Cut At 90 Degrees	3-1/8" (79.37 mm)	3-1/8" (79.37 mm)	3-1/8" (79.37 mm)	3-1/8" (79.37 mm)
Maximum Depth of Cut At 45 Degrees	2-1/8" (53.97 mm)	2-1/8" (53.97 mm)	2-1/8" (53.97 mm)	2-1/8" (53.97 mm)
Max Rip Right of Blade w/Included Fence & Rails	31" (787.4 mm)	37"(940 mm)	37" (940 mm)	53" (1346.2 mm)
Max Rip Left of Blade w/Included Fence & Rails	19-5/8" (500 mm)	19-5/8" (500 mm)	19-5/8" (500 mm)	19-5/8" (500 mm)

	FUSION F1	FUSION F2	FUSION F3	FUSION F3 52
Additional Blade Information				
Included Blade	10" x 60T	10" x 60T	10" x 60T	10" x 60T

Living Knife/Spreader Thickness	3/32" (2.28 mm)	3/32" (2.28 mm)	3/32" (2.28 mm)	3/32" (2.28 mm)
Required Blade Body Thickness	>3.0mm	>3.0mm	>3.0mm	>3.0mm
Required Blade Kerf Thickness	<2.0mm	<2.0mm	<2.0mm	<2.0mm

	FUSION F1	FUSION F2	FUSION F3	FUSION F3 52
Table Information				
Floor to Table Height	34-3/8" (873 mm)	34-7/8" (886.5 mm)	34-7/8" (886 mm)	34-7/8" (886 mm)
Table Size with Extension Wings Width	44" (1118 mm)	44" (1118 mm)	60" (1547 mm)	76-7/8" (1953 mm)
Table Size with Extension Wings Depth	27" (686 mm)	27" (686 mm)	30" (684 mm)	30" (684 mm)
Distance Front of Table to Center of Blade	13-1/2" (342 mm)	13-3/8" (340 mm)	13-1/2" (342 mm)	13-1/2" (342 mm)
Distance Front of Table to Blade At Maximum Cut	8-5/8" (220 mm)	8-5/8" (220 mm)	8-5/8" (220 mm)	8-5/8" (220 mm)
Main Table Size Thickness	1-1/2" (38 mm)	1-1/2" (38 mm)	1-1/2" (38 mm)	1-1/2" (38 mm)

	FUSION F1	FUSION F2	FUSION F3	FUSION F3 52
Fence Information				
Fence Type	Camlock T-Shape w/Aluminum Face	Camlock T-Shape w/European Hi-Lo Face	Camlock T-Shape w/European Hi-Lo Face	Camlock T-Shape w/European Hi-Lo Face
Fence Size Length	33-1/2" (850 mm)	33-1/2" (850 mm)	33-1/2" (850 mm)	33-1/2" (850 mm)
Fence Size Width	9-7/8" (250 mm)	9-7/8" (250 mm)	9-7/8" (250 mm)	9-7/8" (250 mm)
Fence Size Height	2-1/2" (62 mm)	3" (77 mm)	3" (77 mm)	3" (77 mm)
Fence Rail Type	Aluminum Extrusion/Angle Steel	Aluminum Extrusion/Angle Steel	Steel/Angle Steel	Steel/Angle Steel
Fence Rail Length	59-3/8" (1508 mm)	66-5/8" (1691 mm)	67-7/8" (1724 mm)	67-7/8" (1724 mm)
Fence Rail Width	2-7/8" (74.2 mm)	2-7/8" (74.2 mm)	3" (76.2 mm)	3" (76.2 mm)
Fence Rail Height	2" (50.8 mm)	2" (50.8 mm)	2" (50.8 mm)	2" (50.8 mm)
Miter Gauge Information				
Miter Gauge Slot Type	T-Slot	T-Slot	T-Slot	T-Slot
Miter Gauge Slot Size Width	3/4" (19 mm)	3/4" (19 mm)	3/4" (19 mm)	3/4" (19 mm)
Miter Gauge Slot Size Height	3/8" (9.8 mm)	3/8" (9.8 mm)	3/8" (9.8 mm)	3/8" (9.8 mm)

	FUSION F1	FUSION F2	FUSION F3	FUSION F3 52
Construction				
Table	Precision-Ground Cast Iron	Precision-Ground Cast Iron	Precision-Ground Cast Iron	Precision-Ground Cast Iron
Wings	Pre-Formed Steel	Precision-Ground Cast Iron	Precision-Ground Cast Iron	Precision-Ground Cast Iron
Cabinet	Pre-Formed Steel	Pre-Formed Steel	14 Ga. Steel	14 Ga. Steel

Trunnions	Cast Alloy	Cast Alloy	Cast Iron	Cast Iron
Body Assembly	Pre-Formed Steel	Pre-Formed Steel	14 Ga. Steel	14 Ga. Steel
Fence Assembly	Aluminum Extruded Body	Aluminum Extruded Body	Steel Body	Steel Body
Rails	Steel	Steel	Industrial Steel	Industrial Steel
Miter Gauge Construction	Aluminum Body with Steel Bar	Aluminum Body with Steel Bar	Cast Iron with Steel Bar, Aluminum Fence	Cast Iron with Steel Bar, Aluminum Fence
Guard	Steel and Clear Plastic	Steel and Clear Plastic	Steel and Clear Plastic	Steel and Clear Plastic
Body/Cabinet Paint Type/Finish	Powder Coated	Powder Coated	Powder Coated	Powder Coated
Arbor Bearings	Sealed & Permanently Lubricated	Sealed & Permanently Lubricated	Sealed & Permanently Lubricated	Sealed & Permanently Lubricated

	FUSION F1	FUSION F2	FUSION F3	FUSION F3 52
Other Related Information				
Number of Dust Ports	1.00	1.00	1.00	1.00
Dust Port Size	4" (101.6 mm)	4" (101.6 mm)	4" (101.6 mm)	4" (101.6 mm)
Compatible Mobile Base	YES	Integrated	Integrated	Integrated
Blade Guard Dust Port Size	1-1/2" (38.1 mm)	1-1/2" (38.1 mm)	1-1/2" (38.1 mm)	1-1/2" (38.1 mm)
Dust Collection CFM Requirement (min.)	400 CFM	400 CFM	400 CFM	400 CFM
Dust Collection Static Pressure	5" H20	5" H20	5" H20	5" H20

	FUSION F1	FUSION F2	FUSION F3	FUSION F3 52
Product Dimensions				
Weight, Gross	214 lbs. (97 Kg)	359 lbs. (163 Kg)	496 lbs. (225 Kg)	523 lbs. (237 Kg)
Weight, Net	195 lbs. (88.5 Kg)	276 lbs. (124.6 Kg)	397 lbs. (180 Kg)	422 lbs. (191 Kg)
Overall Width (side-to-side)	58-3/4" (1494 mm)	66-3/4" (1697 mm)	68-7/8" (1751 mm)	84-7/8" (2157.47 mm)
Overall Depth (front-to-back)	37-1/4" (945 mm)	39-3/8" (1000 mm)	56-1/8" (1425 mm)	56-1/8" (1425 mm)
Overall Height	42-1/2" (1080 mm)	42-7/8" (1090 mm)	42-7/8" (1090 mm)	42-7/8" (1090 mm)
Footprint Width	20-1/2" (520.6 mm)	19-1/4" (490 mm)	20-1/2" (520 mm)	48" (1219.2 mm)
Footprint Length	20-5/8" (525 mm)	18-5/8" (473 mm)	42-1/2" (1080 mm)	42-1/2" (1080 mm)
Space Required for Full Range of Movement Width (side-to-side)	58-3/4" (1494 mm)	66-3/4" (1697 mm)	68-7/8" (1751 mm)	85" (2157.47 mm)
Space Required for Full Range of Movement Depth (front-to-back)	37-1/4" (945 mm)	39-3/8" (1000 mm)	56-1/8" (1425 mm)	56-1/8" (1425 mm)

	FUSION F1	FUSION F2	FUSION F3	FUSION F3 52
Shipping Dimensions				
Carton Number	1.00	1.00	1.00	1.00
Carton Type	Box	Wood Crate	Wood Crate	Wood Crate
Content	Everything	Everything	Everything	Table saw

Weight, Gross	214 Lbs (97 Kg)	359 lbs. (163 Kg)	482 lbs. (219 Kg)	482 lbs. (219 Kg)
Length	42-3/8" (1075 mm)	49-1/4" (1250 mm)	57" (1450 mm)	51-1/8" (1300 mm)
Width	26-3/4" (680 mm)	29-7/8" (760 mm)	29-7/8" (760 mm)	29-7/8" (760 mm)
Height	25-5/8" (650 mm)	42-3/4" (1085 mm)	42-3/4" (1085 mm)	42-3/4" (1085 mm)
Must Ship Upright	YES	YES	YES	YES
Carton Number				2.00
Carton Type				Wood Crate
Content				52" Fence Rails
Weight, Gross				51.58 lbs. (23.4 Kg)
Length				69-3/4" (1775 mm)
Width				4-1/8" (105 mm)
Height				3-7/8" (100 mm)
Must Ship Upright				YES

	FUSION F1	FUSION F2	FUSION F3	FUSION F3 52
ELECTRICAL				
Power Requirement	110V, Single-Phase, 60 Hz	110V, Single-Phase, 60 Hz	220V, Single-Phase, 60 Hz	220V, Single-Phase, 60 Hz
Prewired Voltage	110V	110V	220V	220V
Full-Load Current Rating	13A	14A	15A	15A
Minimum Circuit Size	20A	20A	20A	20A
Connection Type	Cord & Plug	Cord & Plug	Cord & Plug	Cord & Plug
Power Cord Included	Yes	Yes	Yes	Yes
Power Cord Length	6 ft.	6 ft.	6 ft.	6 ft.
Power Cord Gauge	14 AWG	14 AWG	14 AWG	14 AWG
Plug Included	Yes	Yes	Yes	Yes
Switch Type	ON/OFF Push Button Switch w/Large Shut-Off Paddle & Padlock	ON/OFF Push Button Switch w/Large Shut-Off Paddle & Padlock	ON/OFF Push Button Switch w/Large Shut-Off Paddle & Padlock, Additional Magnetic Contactor in line	ON/OFF Push Button Switch w/Large Shut-Off Paddle & Padlock, Additional Magnetic Contactor in line

	FUSION F1	FUSION F2	FUSION F3	FUSION F3 52
MOTOR				
Use	Main	Main	Main	Main
Horsepower	1.5HP	1.75HP	3HP	3HP
Phase	Single-Phase	Single-Phase	Single-Phase	Single-Phase
Amps	13A	14A	15A (220V)	15A (220V)
Speed	3600 RPM	3450 RPM	3450 RPM	3450 RPM
Type	TEFC Capacitor-Start Induction	TEFC Capacitor-Start Induction	TEFC Capacitor-Start Induction	TEFC Capacitor-Start Induction
Power Transfer	Poly-V Belt Drive	Poly-V Belt Drive	Poly-V Belt Drive	Poly-V Belt Drive
Bearings	Sealed & Permanently Lubricated	Sealed & Permanently Lubricated	Sealed & Permanently Lubricated	Sealed & Permanently Lubricated

	FUSION F1	FUSION F2	FUSION F3	FUSION F3 52
--	-----------	-----------	-----------	--------------

OTHER SPECIFICATIONS				
Country of Origin	Taiwan	Taiwan	Taiwan	Taiwan
Warranty	1 Year	1 Year	1 Year	1 Year
Approximate Assembly & Setup Time	1 Hour	1 Hour	1 Hour	1 Hour
Serial Number Location	ID label on cabinet	ID label on cabinet	ID label on cabinet	ID label on cabinet
Sound Rating	60-78 dB	60-78 dB	60-78 dB	60-78 dB
ISO 9001 Factory	Yes	Yes	Yes	Yes
Certified by a Nationally Recognized Testing Laboratory (NRTL)	Yes	Yes	Yes	Yes

Wiring Diagram

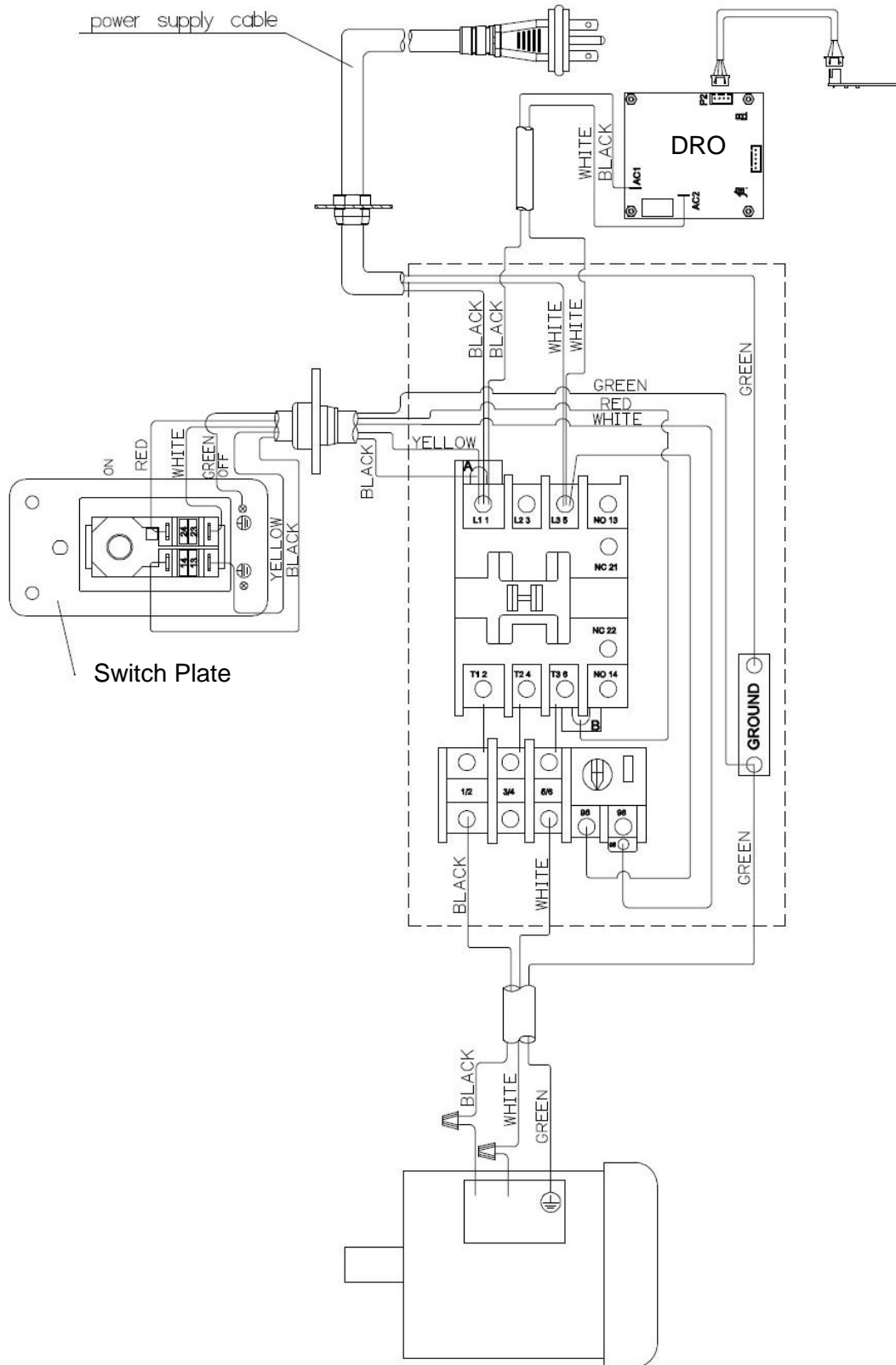

Replacement Parts Diagram

Cabinet

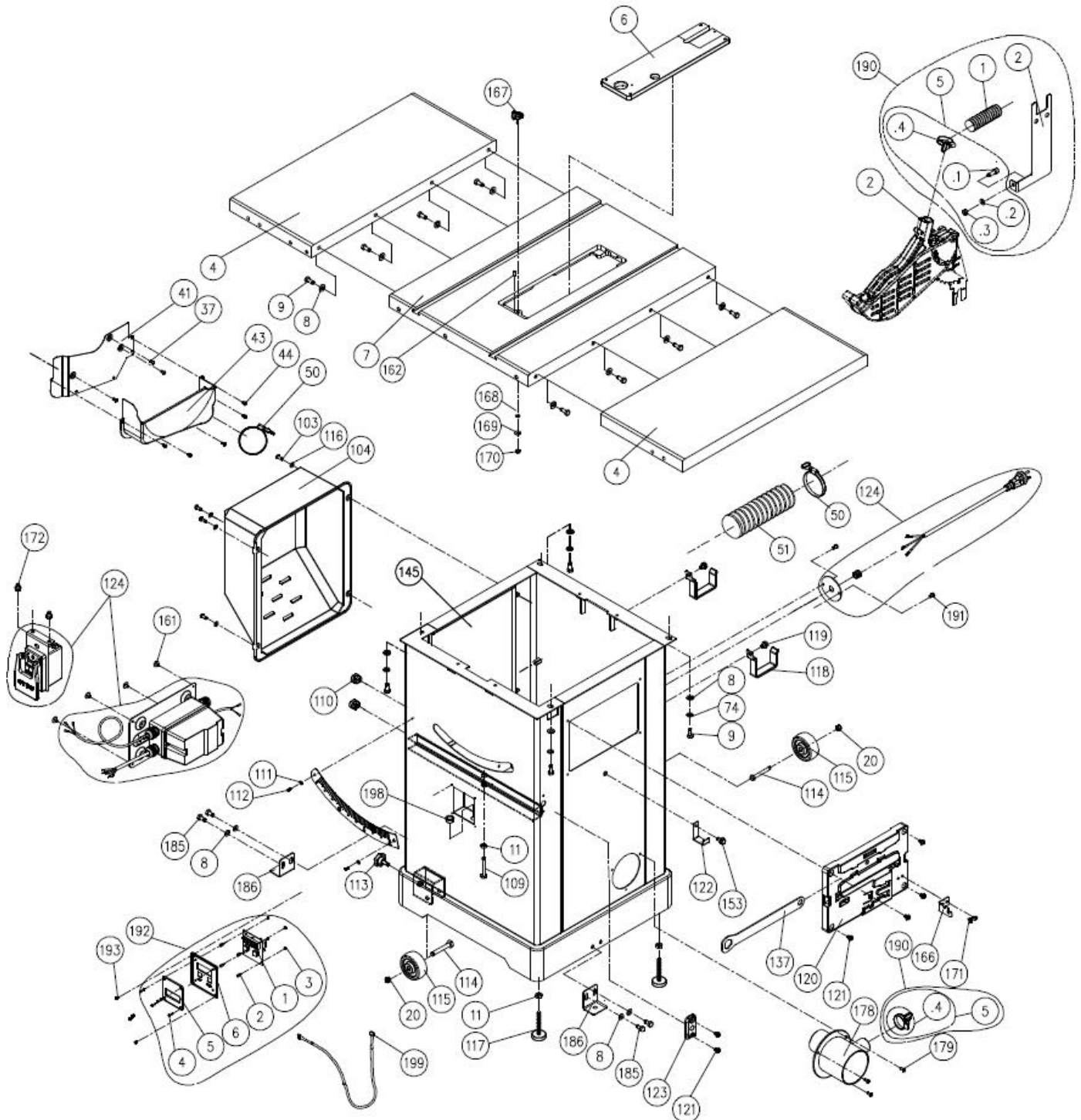

Blade Guard & Miter Gauge

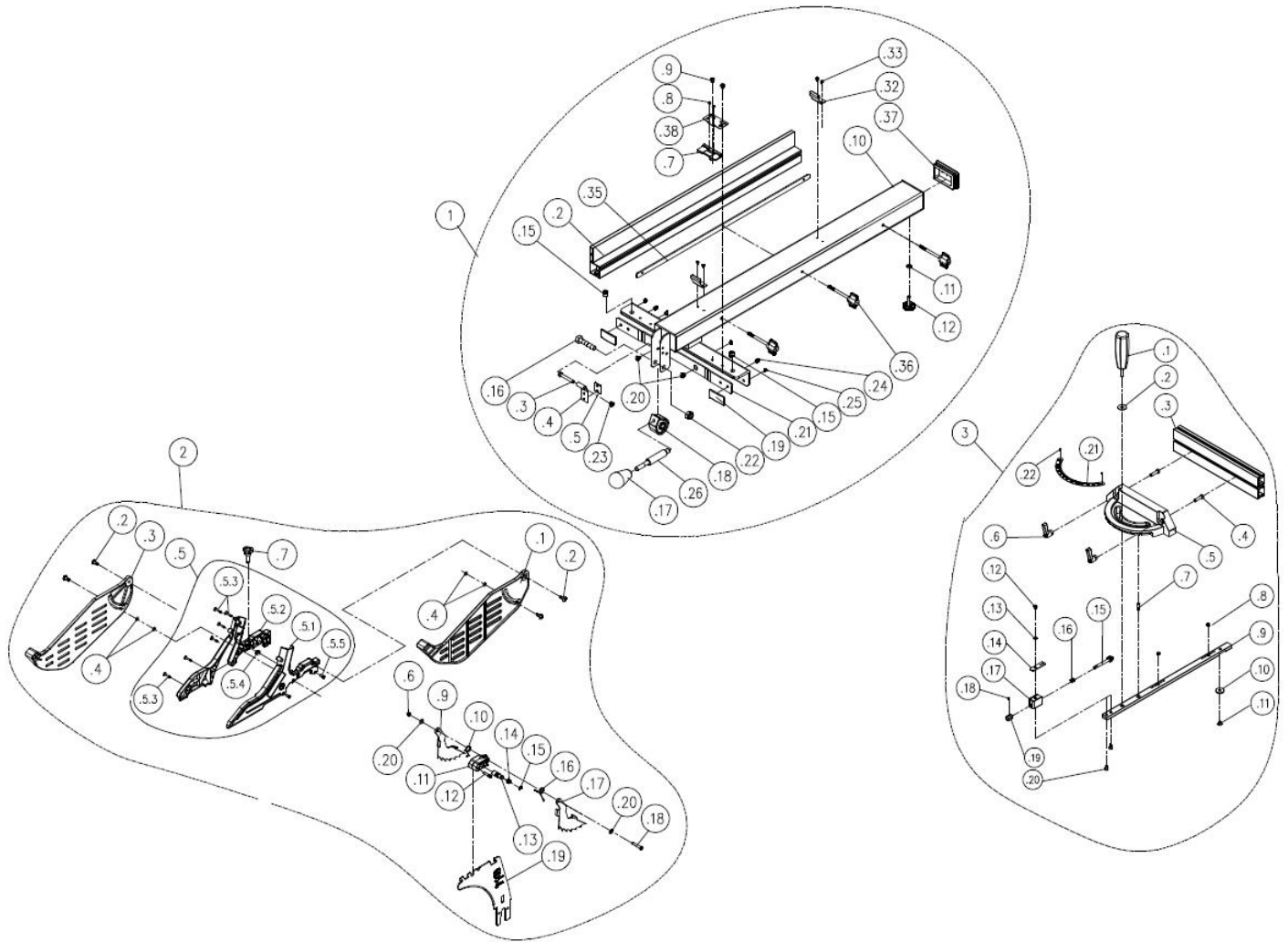

36" Rails, Fence, Guard & Outfeed Table

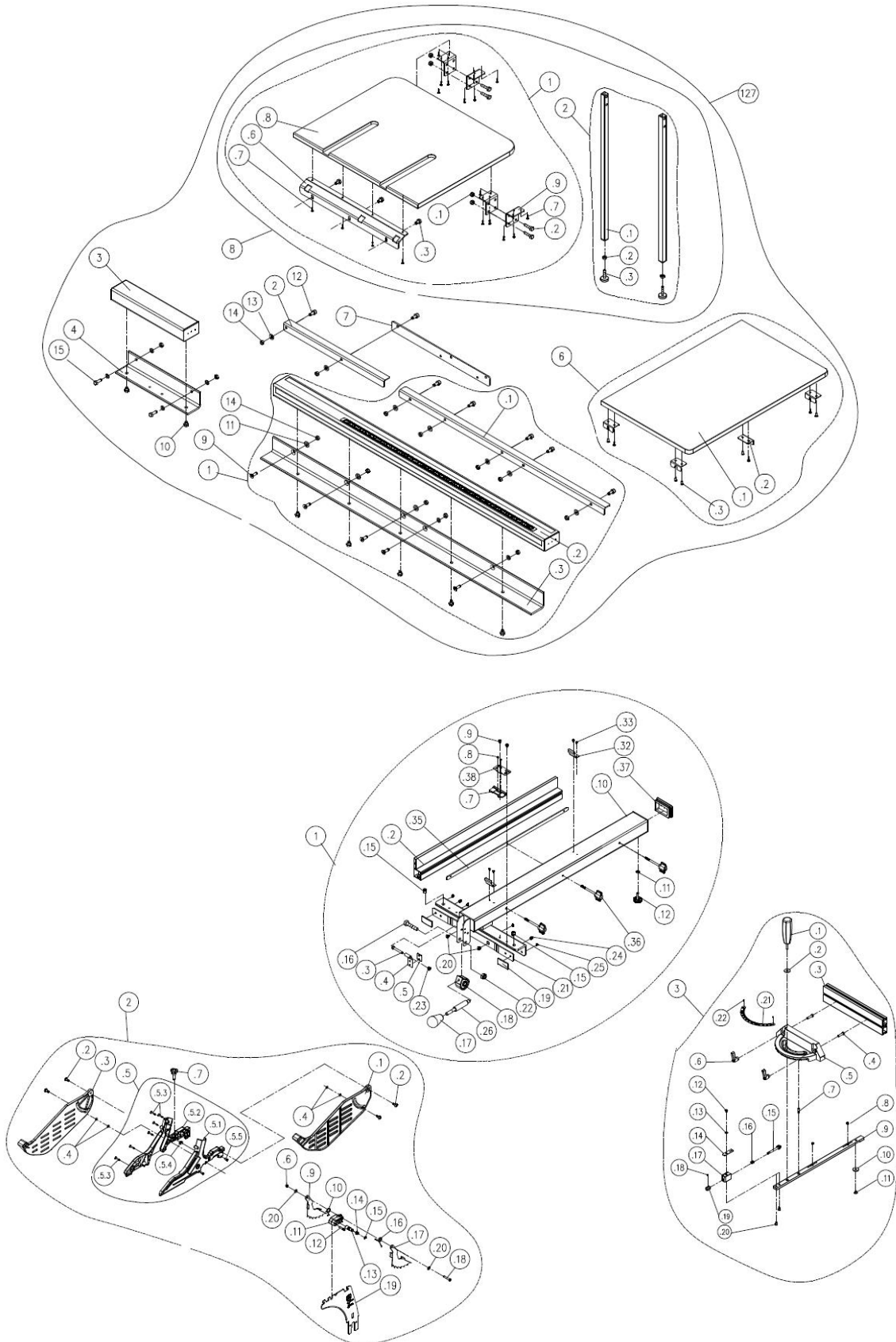

52" Rails, Fence, Guard & Outfeed Table

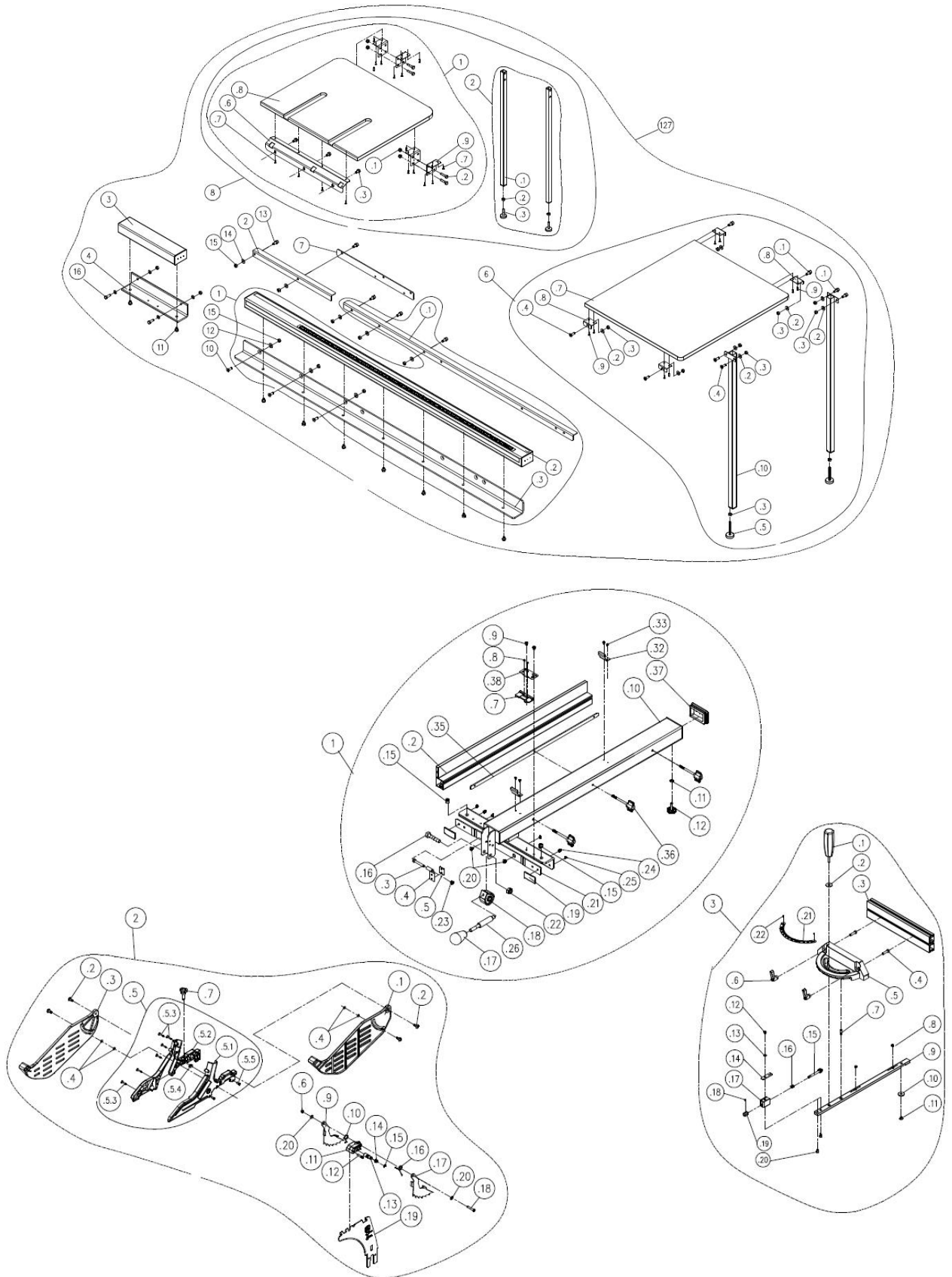

Parts List

Key	Part No.	Description	Specifications	Qty
1	925199-000	Fence Assembly	L\H (800mm)	1
.2	310587-909	Adaptor	800mm	1
.3	000002-308	Hex Screw	M6-1.0x45	1
.4	171993-904	Bracket		1
.5	250602-621	Frictional Plate		1
.7	251456-620	Pointer	(LH)	1
.8	001101-205	Pan Head Tapping Screw	M3-1.06x6	2
.9	000304-210	Pan Head Screw	M6-1.0x6	2
.10	174903-308	Fence Body		1
.11	008005-100	Hex Nut	M6-1.0 (10Bx5H)	1
.12	250587-615	Frictional Wheel		1
.15	250472-621	Plastic Set Screw	M12-1.75	2
.16	000004-306	Hex Screw	M10-1.5x50	1
.17	230282-615	Ball		1
.18	922141-000	Compress Cam Assembly		1
.19	250471-621	Frictional Plate		2
.20	002103-103	Flat Head Screw	M6-1.0x8	2
.21	171372-904	Bracket for Frictional Plate		1
.22	008308-100	Lock Nut	M10-1P (17Bx12H)	1
.23	008304-100	Lock Nut	M6-1.0 (10Bx6H)	1
.24	001903-105	SET Lock Screw	M8-1.25x8	2
.25	250672-615	Spacer		4
.26	380883-901	Handle Shaft		1
.32	270007-901	Spring Plate		2
.33	000302-101	Pan Head Screw	M4-0.7x6	4
.35	174713-000	Fix Plate		1
.36	251433-615	Wing Screw		3
.37	250624-615	End Cap		1
.38	175051-905	Pointer Bracket		1
2	924883-000	Blade Guard Assembly		1
Key	Part No.	Description	Specifications	Qty
.1	251246-000	Right Cover		1
.2	290073-905	Shoulder Shaft		4
.3	251247-000	Left Cover		1
.4	043317-000	O-Ring	P006	4

Fusion 3 Table Saw \ Replacement Parts Table \

.5	924884-000	Blade Guard support Assembly		1
.5.1	924885-000	Support (L)		1
.5.2	924886-000	Support (R)		1
.5.3	001201-002	Tapping Screw	M4-1.41x20	6
.5.4	008005-200	Hex Nut	M6-1.0P (10Bx5H)	1
.5.5	360960-901	Pin		2
.6	008302-100	Lock Nut	M5-0.8 (8Bx6H)	1
.7	230336-615	Bolt		1
.9	171378-904	Anti-Kick Finger -Left		1
.10	280162-901	Spring		1
.11	251311-615	Block		1
.12	360864-000	Pin		1
.13	360865-901	Spreader Shaft		1
.14	280160-901	Spring		1
.15	010204-000	Retaining Ring	ETW-7	1
.16	280163-901	Spring		1
.17	171379-904	Anti-Kick Finger -Right		1
.18	000303-110	Pan Head Screw	M5-0.8x30	1
.19	174397-904	Spreader		1
.20	006001-012	Flat Washer	5.3x12x1.0	2
3	924562-000	Miter Gauge Assy		1
.1	230191-000	Handle		1
.2	006002-056	Flat Washer	8.5x23x2	1
.3	310500-911	Apron		1
.4	003001-102	Hex Screw	1/4"-20x1"	2
.5	090342-008	Miter Gauge Body		1
.6	230408-000	Lock Handle		2
.7	360355-901	Pin		1
.8	000204-114	SET Screw	M8-1.25x6	2
.9	381390-904	Slot Bar		1
Key	Part No.	Description	Specifications	Qty
.10	130380-903	Washer		1
.11	000403-209	Flat Head Phillip Screw	M6-1.0x8	1
.12	000303-202	Pan Head Screw	M5-0.8x8	1
.13	006002-009	Flat Washer	5.2-10x1.0	1
.14	251305-620	Pointer		1
.15	924563-000	Adjusting Wheel Assembly		1
.16	280272-000	Spring		1
.17	130378-903	Spacer		1
.18	000201-105	SET Screw	M4-0.7x4	1
.19	381388-904	Handle		1

.20	000102-102	Cap Screw	M5-0.8x8	2
.21	574852-000	Scale		1
.22	002301-201	Rivet	2x5	2
4	051386-000	Extension Table		2
6	924397-000	Table Insert Assembly		1
7	051368-000	Table		1
8	006001-049	Flat Washer	8.5-16x2.0	22
9	000003-104	Hex Screw	M8-1.25x20	12
10	051370-000	Up-down Bracket		1
11	008006-100	Hex Nut	M8-1.25 (13x6.5)	7
12	280258-905	Spring		1
13	000104-106	Cap Screw	M8-1.25x20	2
14	901081-000	Motor Assy	3HP/230V/60HZ/1PH/2P	1
15	006001-069	Flat Washer	10x20x3.0	1
16	006307-100	Spring Washer	10.2-18.5	1
17	000004-103	Hex Screw	M10-1.5x30	1
18	360863-901	Motor Fixing Shaft		1
19	008308-100	Lock Nut	M10-1.5 (17Bx12H)	1
20	008306-100	Lock Nut	M8-1.25 (13Bx9H)	3
21	010005-000	Retaining Ring	STW-14	1
22	130359-903	Bracket for Riving Knife		1
23	000104-104	Cap Screw	M8-1.25x16	2
24	280259-901	Spring		1
25	130363-903	Bushing		1
Key	Part No.	Description	Specifications	Qty
26	110073-000	Bracket for Riving Knife		1
27	174396-904	Riving Knife		1
28	001902-710	SET Lock Screw	M6-1.0x8	4
29	000804-106	Round Head Screw	M5-0.8x16	2
30	361251-905	Pin		1
31	361250-901	Fixing Knob		1
32	110071-000	Lock Handle		1
33	390017-000	Sawblade	10"/40T	1
34	174399-901	Sawblade clamp		1
35	380205-901	Nut	TW5/8"-12	1
37	002503-101	Round Head Socket Lock Screw	M5-0.8x12	8
38	051369-000	Upper Trunnion		1
40	002601-107	Locking CAP screw	M8-1.25x25	2
41	174773-000	Fixing Plate		1

Fusion 3 Table Saw \ Replacement Parts Table \

43	251398-615	Dust Hood		1
44	002002-101	Round Head Phillip Screw	M5-0.8x8	5
46	174325-156	Arbor Lock Handle		1
47	280260-901	Spring		1
48	010206-000	Retaining Ring		2
50	042608-000	Clamp	60-80mm (I.D.)	2
51	042620-008	Dust Hose	2.5" (I.D.) 800mm	1
58	014354-000	Poly-V-Belt	135J-7	1
59	925157-000	Arbor Assembly		1
.1	008316-200	Lock Nut	M10-1.5 (17Bx8H)	1
.2	006001-075	Flat Washer	10.3x22x2.0	1
.3	010103-000	Retaining Ring	RTW-35	1
.4	030211-002	Ball Bearing	6003	2
.5	190270-901	Spacer		1
.6	174305-901	Fixed Plate		1
.7	381281-902	Arbor		1
60	000002-103	Hex Screw	M6-1.0x16	1
61	006001-020	Flat Washer	6.2x20x3.0	1
Key	Part No.	Description	Specifications	Qty
62	006007-114	Flat Washer	6.4x16x1.6	1
63	361245-901	Lead Screw		1
64	010007-000	Retaining Ring	STW-16	1
65	012002-003	Key	4x4x8	2
66	174324-000	Washer		1
67	031011-001	Bearing	51100	2
68	090324-000	#N/A		1
69	381474-000	Bevel Gear		1
70	006001-025	Flat Washer	6.4x16x1.0	1
71	008317-300	Lock Nut	M6-1.0 (10Bx5H)	2
72	361246-000	Column		2
73	002601-108	Locking CAP screw	M8-1.25x35	2
74	006305-100	Spring Washer	8.2x15.4	15
75	006001-078	Flat Washer	10.5x19x1.5	1
76	190273-901	Bushing		1
77	000202-101	SET Screw	M5-0.8x5	4
78	051469-000	#N/A		1
79	011004-103	Spring Pin	6x25	2
80	175012-156	Pointer		1
81	002402-101	Round Head Lock Screw w/Washer	M5-0.8x12/5x10.5x1.0	1

82	361429-901	Shaft		1
83	251455-615	Bushing		1
84	924505-000	Handwheel Assembly		2
84	240090-000	Handwheel		1
84	230284-000	Folding Handle		1
84	000403-103	Flat Head Phillip Screw	M6-1.0x12	1
85	920703-000	Fixing Knob		2
86	051470-000	Worm Bracket		1
88	660229-000	Magnetic Ring		1
89	006706-100	Wave Washer	WW-18	1
90	006001-203	Flat Washer	18-28x1	1
91	010009-000	Retaining Ring	STW-18	1
93	000104-110	Cap Screw	M8-1.25x30	2
Key	Part No.	Description	Specifications	Qty
94	360709-901	Worm Shaft		1
95	001902-109	SET Lock Screw	M6-1.0x6	2
96	012002-006	Key	4x4x16	1
97	130126-903	Lock Ring		1
98	006006-120	Flat Washer	20x10.2±0.1x2±0.1	1
99	006004-167	Flat Washer	13x28x0.8	1
100	000104-108	Cap Screw	M8-1.25x25	3
101	361428-901	Shaft		1
102	381463-901	Bushing		1
103	000304-107	Pan Head Screw	M6-1.0x16	4
104	251239-615	Motor Cover		1
105	051135-000	Trunnion Support		2
106	000003-105	Hex Screw	M8-1.25x25	6
109	000003-115	Hex Screw	M8-1.25x55	1
110	020003-000	Strain Relief	SB7R-3	1
111	006001-001	Flat Washer	4.3x10x1.0	2
112	000302-102	Pan Head Screw	M4-0.7x8	2
113	004001-101	Knob	5/16"-18x3/4"	2
114	000003-316	Hex Screw	M8-1.25x60	2
115	250399-615	Wheel		2
116	006001-022	Flat Washer	6.3x13x1.0	4
117	230041-000	Leveling foot		2
118	170541-904	Slide Shelf		2
119	049201-101	Hex Screw w/Flat Washer	M8-1.25x16 (13Bx6.5H)	2
120	251251-615	Storage Box		1

Fusion 3 Table Saw \ Replacement Parts Table \

121	001603-102	Round Head Screw w/Washer	M6-1.0x10/6x13.2x1.0	6
122	170965-904	Fix Plate		1
123	250407-615	Worm Shaft Bracket		1
124	938085-000	Magnetic Switch Assy	3HP	1
127A	924914-000	36" Rail. Right Table. Rear Table Assembly		1
1	924915-000	36" Rail Assembly	36"	1
.1	924923-000	Rear Rail	36"	1
Key	Part No.	Description	Specifications	Qty
.2	924916-000	Front Rail Assembly	36"	1
.3	924917-000	Front Rail Bracket	36"	1
2	924783-000	Rear Rail (L)		1
3	924768-000	Front Rail (L)		1
4	924772-000	Front Rail Bracket (L)		1
6	924773-000	Right Table Assembly		1
.1	440098-000	Right Table		1
.2	173139-902	Brace		4
.3	230086-901	Tapping Screw		8
7	924969-901	Connect Plate		1
8	924796-000	Rear Table Leg Assembly		1
.1	924797-000	Rear Table Leg Assembly		1
.1	008308-100	Lock Nut	M10-1.5 (17Bx12H)	4
.2	000004-112	Hex Screw	M10-1.5x45	4
.3	049201-101	Hex Screw w/Flat Washer	M8-1.25x16 (13Bx6.5H)	3
.5	174780-308	Support Plate		1
.6	001102-505	Round Hear Tapping Screw	M4-1.59x16	16
.7	440099-000	Rear Table		1
.8	171301-904	Fixed Plate		4
.2	924798-000	Leg Assembly		1
.1	190208-365	Leg		2
.2	008006-100	Hex Nut	M8-1.25 (13Bx6.5H)	2
.3	230041-000	Leveling foot	S20C+NBR	2
9	000704-102	Flat Head Hex. Screw	M8-1.25x25	5
10	049201-102	Hex Screw w/Flat Washer	M8-1.25x12 (13Bx5.5H)	7
11	006305-100	Spring Washer	8.2x15.4	3
12	001803-103	CAP Screw w/ Spring Washer	M8-1.25x25/8.2x13.7	7
13	006001-049	Flat Washer	8.5x16x2.0	16
14	008006-100	Hex Nut	M8-1.25 (13Bx6.5H)	14
15	000003-105	Hex Screw	M8-1.25x25	2
127B	924970-000	52" Rail. Right Table. Rear Table		1

		Assembly		
Key	Part No.	Description	Specifications	Qty
1	924971-000	52" Rail. Right Table. Rear Table Assembly	52"	1
.1	924924-000	Rear Rail	52"	1
.2	924920-000	Front Rail Assembly	52"	1
.3	924921-000	Front Rail Bracket	52"	1
2	924783-000	Rear Rail (L)		1
3	924768-000	Front Rail (L)		1
4	924772-000	Front Rail Bracket (L)		1
6	924809-000	Right Table Assembly		1
.1	001803-102	CAP Screw w/ Spring Washer	M8-1.25x20/8.2x15.4	4
.2	006001-049	Flat Washer	8.5x16x2.0	8
.3	008006-100	Hex Nut	M8-1.25 (13Bx6.5H)	10
.4	000704-102	Flat Head Hex Screw	M8-1.25x25	4
.5	230041-000	Leveling foot		2
.7	440077-000	Right Table		1
.8	173139-902	Brace		4
.9	230086-901	Tapping Screw		8
.10	190205-308	Leg		2
7	924969-000	Connect Plate		1
8	924796-000	Rear Table Leg Assembly		1
.1	924797-000	Rear Table Leg Assembly		1
.1	008308-100	Lock Nut	M10-1.5 (17Bx12H)	4
.2	000004-112	Hex Screw	M10-1.5x45	4
.3	049201-101	Hex Screw w/Flat Washer	M8-1.25x16 (13Bx6.5H)	3
.5	174780-308	Support Plate		1
.6	001102-505	Round Hear Tapping Screw	M4-1.59x16	16
.7	440099-000	Rear Table		1
.8	171301-904	Fixed Plate		4
.2	924798-000	Leg Assembly		1
.1	190208-365	Leg		2
.2	008006-100	Hex Nut	M8-1.25 (13Bx6.5H)	2
.3	230041-000	Leveling foot	S20C+NBR	2
10	000704-102	Flat Head Hex Screw	M8-1.25x25	3
Key	Part No.	Description	Specifications	Qty

Fusion 3 Table Saw \ Replacement Parts Table \

11	049201-102	Hex Screw w/Flat Washer	M8-1.25x12/(13Bx5.5H)	9
12	006305-100	Spring Washer	8.2x15.4	3
13	001803-103	CAP Screw w/ Spring Washer	M8-1.25Px25/8.2x13.7	5
14	006001-049	Flat Washer	8.5-16x2.0	9
15	008006-100	Hex Nut	M8-1.25 (13Bx6.5H)	10
16	000003-105	Hex Screw	M8-1.25x25	2
130	251362-615	Push Sticks		1
133	040002-000	Hex Wrench	2.5 mm	1
134	040006-000	Hex Wrench	6 mm	1
135	174569-904	Open Wrench	10/13 mm	1
137	174315-904	Arbor Wrench		1
145	175013-000	Stand		1
152	012002-005	Key	4x4x12	2
153	049201-101	Hex Screw w/Flat Washer	M8-1.25x16/(13Bx6.5H)	1
160	043322-000	O-Ring	P11	1
161	002402-102	Round Head Lock Screw w/Washer	M5-0.8x10-5x16x1.5	4
162	011001-103	Spring Pin	3x10	1
166	174398-904	Hook		1
167	251243-615	Knob		1
168	006701-100	Wave Washer	WW-6	1
169	006001-137	Flat Washer	5.3x16x1.5	1
170	008302-100	Lock Nut	M5-0.8 (8Bx6H)	1
171	001104-703	Round Hear Tapping Screw	M5-2.12x12	2
172	049201-102	Hex Screw w/Flat Washer	M8-1.25x12/(13Bx5.5H)	2
173	040013-000	Hex Wrench	5 mm	1
176	006001-045	Flat Washer	8.5x16x1.0	3
178	251418-615	Hose Adapter		1
179	000303-104	Pan Head Screw	M5-0.8x12	3
181	006702-100	Wave Washer	WW-8	2
185	000003-102	Hex Screw	M8-1.25x16	4
Key	Part No.	Description	Specifications	Qty
186	174711-000	Fix Plate		2
189	174772-000	Plate		1
190A	924854-000	Over Head Guards Assembly	36"	1
1	042620-015	Dust Hose	1.5 / 2700mm (I.D.)	1
2	174887-904	Brace		1

5	850913-000	Hardware Bag for 36" Over-Head Guards		1
.1	001803-103	CAP Screw w/ Spring Washer	M8-1.25x25/8.2x13.7	1
.2	006001-049	Flat Washer	8.5x16x2.0	1
.3	008006-100	Hex Nut	M8-1.25 (13Bx6.5H)	1
.4	042622-003	Clamp	30-45 mm (I.D.)	2
190B	924855-000	Over Head Guards Assembly	52"	1
1	042620-016	Dust Hose	1.5 / 3700mm (I.D.)	1
2	174887-904	Brace		1
5	850913-000	Hardware Bag for 52" Over Head Guards		1
.1	042622-003	Clamp	30-45 mm (I.D.)	2
.2	001803-103	CAP Screw w/ Spring Washer	M8-1.25x25/8.2x13.7	1
.3	006001-049	Flat Washer	8.5x16x2.0	1
.4	008006-100	Hex Nut	M8-1.25 (13Bx6.5H)	1
191	000304-102	Pan Head Screw	M6-1.0x10	2
192	950848-000	Tilt DRO Assembly		1
193	000805-101	Round Head Screw	M4-0.7x6	4
194	491221-000	Plate		1
195	175025-000	Fixed Plate		1
196	000301-201	Pan Head Screw	M3-0.5x6	1
197	000102-103	Cap Screw	M5-0.8x10	1
198	021808-000	Wire Clamp	NB-1419	1
199	474048-018	Cord	24AWG/4C/550mm	1
201	002504-701	Round Head Socket Lock Screw	M4-0.7x10	1
202	006003-199	Flat Washer	4.3x14x2.0	1
203	381479-000	Bevel Gear		1

NOTES:

WARRANTY & REGISTRATION

THANK YOU!

Welcome to the Laguna Tools® group of discriminating woodworkers. We understand that you have a choice of where to purchase your machines and appreciate the confidence you have in the Laguna Tools® brand.

Through hands-on experience, Laguna Tools® is constantly working hard to make innovative, precision products. Products that inspire you to create works of art, are a joy to operate, and encourage your best work.

Laguna Tools®
Imagination, Innovation, and Invention at Work

WARRANTY & REGISTRATION

Every product sold is warranted to be free of manufacturers' defective workmanship, parts, and materials. For any questions about this product, the intended use or what it was designed for, customer service, or replacement parts, please contact our customer service department:

Laguna Tools® Customer Service
2072 Alton Parkway, Irvine, California 92606, USA
1-800-332-4049
customerservice@lagunatools.com
www.lagunatools.com/why/customer-service/
8AM. to 5PM PST, Monday through Friday

For warranty claims or to report damage upon receiving – please reach out to our warranty department:

Laguna Tools® Warranty Service
2072 Alton Parkway, Irvine, California 92606, USA
1-949-474-1200
customerservice@lagunatools.com
www.lagunatools.com/policies/warranty
8AM to 5PM PST, Monday through Friday

REGISTRATION

To prevent voiding this warranty, all products sold must be registered within thirty (30) days of receiving the product. Registering the product will enable the original purchaser to receive notifications about important product changes, receive customer service, and be able to file a warranty claim against defective workmanship, parts, or materials.

WHO IS COVERED

The applicable warranty covers only the initial purchaser of the product from the date of receiving the product. To file such claims, the original purchaser must present the original receipt as proof of purchase.

WHAT IS COVERED

The warranty covers any defects in the workmanship of all parts and materials that make up the machine unless otherwise specified. Any part, determined by Laguna Tools®, to have a defect will be repaired or replaced (and shipped), without charge. The defective item/part must be returned to Laguna Tools® with the complaint and proof of purchase in the original packaging that it was received in. In the event the item/part is determined to be not covered by this warranty, the customer will be responsible for the cost to replace the item/part and all related shipping charges.



WARRANTY LIMITATIONS

This limited warranty does not apply to natural disasters, acts of terrorism, normal wear and tear, product failure due to lack of maintenance or cleaning, damage caused by accident, neglect, or lack-of inadequate dust collection. The warranty may be voided against proof of misuse/abuse, damage caused where repair or alterations have been made or attempted by others, using the product for purposes other than those described as intended use (unless with consent by Laguna Tools®), modification to the product, or use with an accessory that was not designed for the product. It is the responsibility of the user to understand basic woodworking machinery settings and procedures and to properly maintain the equipment in accordance with the standards provided in this manual.

LENGTH OF WARRANTY

All new machines and optional accessories sold through an authorized dealer carry a two-year warranty effective the date of receiving the product. Machines sold for either commercial or industrial use have a one-year warranty. Wearable parts like throat plates, bandsaw guides, etc., have a ninety-day warranty.

Table A-1 Warranty Lengths

2 Year – New Machines Sold Through an Authorized Dealer
2 Year – Accessories Sold as Machine Options (excluding blades)
1 Year – Machines Sold for Commercial or Industrial Use
1 Year – Blades and Accessories outside of Machine Options
90 Days – Wearable Parts

Aside from being free of defects upon receiving, consumable parts, like cutters and abrasives, are not covered by this warranty unless otherwise stated by Laguna Tools®. These parts are designed to be used at the expense of the operator and are available for replacement or inventory purchase. The determination of a consumable part will be made on a case-by-case basis by Laguna Tools®.

SHIPPING DAMAGE

Laguna Tools® is not responsible for damage or loss caused by a freight company or other circumstances not in the direct control of Laguna Tools®. All shipping-related claims for loss or damage goods must be made to Laguna Tools within twenty-four hours of delivery.

HOW TO RECEIVE SUPPORT

To file a warranty-claim please contact the warranty department at 1-949-474-1200. To receive customer service or technical support please contact the customer service department at 1-800-332-4094. Parts, under warranty, are shipped at the expense of Laguna Tools® either by common carrier, FedEx ground services or similar method. Technical support to install replacement parts is primarily provided by phone, fax, email, or the Laguna Tools Customer Support Website.

LAGUNA



Fusion 3 Table Saw

230V/1PH/60Hz w/ 3HP, 36" RIP

MTSF3362203-0130-36



NET WEIGHT: 397 lbs.
GROSS WEIGHT: 496 lbs.

BOX NUMBER

SERIAL NUMBER

READ BEFORE SIGNING

CUSTOMER RESPONSIBILITIES

Note any carton shortages on the carrier's shipping documents.
Note all damages on the carrier's shipping documents.
Note any missing or broken packaging on the carriers shipping documents.

All product shortage claims must be made to Laguna Tools within 2 days from the shipping date; otherwise claim cannot be honored.

CARRIER RESPONSIBILITIES

Do not break down skid
Do not remove any part of packaging
Notify Consignee of any damage
Carrier will be 100% liable for any damage.

LAGUNA
Precision Woodworking



175370

Fusion 3 Table Saw 52"

230V/1PH/60Hz w/ 3HP, 52" RIP

MTSF3362203-0130-52



NET WEIGHT: 422 lbs.
GROSS WEIGHT: 523 lbs.

BOX NUMBER

SERIAL NUMBER

READ BEFORE SIGNING

CUSTOMER RESPONSIBILITIES

Note any carton shortages on the carrier's shipping documents.
Note all damages on the carrier's shipping documents.
Note any missing or broken packaging on the carriers shipping documents.

All product shortage claims must be made to Laguna Tools within 2 days from the shipping date; otherwise claim cannot be honored.

CARRIER RESPONSIBILITIES

Do not break down skid
Do not remove any part of packaging
Notify Consignee of any damage
Carrier will be 100% liable for any damage.

The logo for LAGUNA, featuring the word "LAGUNA" in a bold, white, sans-serif font. A red horizontal line is positioned under the letter "A". The logo is set against a solid black rectangular background.

LAGUNA AMERICAN HEADQUARTERS

Texas: 744 Refuge Way Suite 200, Grand Prairie, Texas 75050, U.S.A. Phone: +1-800-332-4094
Huntington Beach: 7291 Heil Ave Huntington Beach, CA 92647, U.S.A. Phone: +1-949-474-1200
South Carolina: 825 Bistline Dr. Ste 101, West Columbia, SC 29172, U.S.A. Phone: +1-800-234-1976
Minnesota: 5250 West 74th St, Edina, MN 55439, U.S.A Phone: +1-949-474-1200

LAGUNA EUROPE

Walker Rd, Bardonia Hill, Coalville LE67 1TU, United Kingdom. Phone: +44-1530-516921

DAKE CORPORATION

724 Robbins Road, Grand Haven, MI 49417, United States +1-800-937-3253