

LAGUNA

OWNERS'S MANUAL

25x2

SuperMax
Drum Sander



LagunaTools.com

Thank you for investing in a SuperMax 25x2 drum sander by Laguna Tools. This machine is one of a family of unique machines proudly offered by Laguna Tools. Every Laguna machine is engineered for years of dependable service. Please feel free to contact Laguna Tools if you have a question or suggestion. We appreciate working with you and your choice of a Laguna Tools machine for your shop.

Regards,
Torben Helshoj
President & Founder Laguna Tools

This manual applies to the 25x2 double head drum sanders. Enter the model number, serial number and purchase information below for quick reference when ordering accessories, supplies or parts.

Model: _____

Serial: _____

Date of purchase: _____

Place of purchase: _____



25x2 DUAL DRUM SANDER

STOCK NO. 913002

POWER. 230V, 1Ph, 22.4A, 60Hz

SERIAL NO.



Taiwan TCP

Laguna Tools 744 Refuge Way, Suite 200
Grand Prairie TX 75050

800-234-1976

www.lagunatools.com

CONTENTS

ABOUT THE SUPERMAX SYSTEM

Safety Rules	4
Main Components	6
Unpacking	7

SETTING UP

Making Electrical Connections	8
Connecting Dust Collectors	9
Checking Drum Alignment.....	9
Checking Conveyor Belt.....	10
Checking Table Height Controls	11
Monthly Maintenance	11
Installing Abrasive Wraps	12

OPERATING

Basic Operating Procedures	14
Operating Controls.....	14
Setting The Depth of Cut.....	15
Setting Front Drum	15
Setting Rear Drum.....	15
Disengaging Drums	16
Selecting Intellisand™ Feed Rates.....	16
Using The Depth Gauge.....	17
Selecting Drum Abrasives	18
Tips For Maximum Performance	19

TROUBLESHOOTING

Troubleshooting Guide: Motors	21
Troubleshooting Guide: Machine	22
Troubleshooting Guide: Operations	24

SERVICING

Adjusting Height Controls	26
Adjusting Table Support Castings	27
Adjusting Sanding Drums	28
Adjusting Tension Rollers.....	30
Replacing Conveyor Belts	31
Replacing V-Belt	32
Replacing Electrical Components	33
Electrical Diagram.....	33

TECHNICAL DATA

Parts List & Drawing, Stand	34
Parts List & Drawing, Drum Assembly .	37
Parts List & Drawing, Conveyor Assembly	40
Specifications.....	44
French Warnings	46
Accessories & Supplies	47

FOR YOUR SAFETY: Read all instructions carefully, and note the safety cautions within this manual.

IMPORTANT: KEEP THIS MANUAL HANDY

Please read this manual. It was designed to help you get the most from your Laguna/SUPERMAX drum sander. Before unpacking or using the machine, familiarize yourself with its components, features, and basic adjustments by reviewing the following pages. You will find it an invaluable aid in setting up, operating, and servicing your machine.

CAUTION, SAFETY FIRST

When maintaining and operating this machine, always put safety first. For your own safety, read and understand this owner's manual before operating this machine. Always heed and follow all normal safety precautions, including the following:

SAFETY RULES

1. KEEP GUARDS IN PLACE and in working order.
2. REMOVE ADJUSTING KEYS AND WRENCHES. Form habit of checking to see that keys and adjusting wrenches are removed from tool before turning it on.
3. KEEP WORK AREA CLEAN. Cluttered areas and benches invite accidents.
4. DON'T USE IN DANGEROUS ENVIRONMENT. Don't use power tools in damp or wet locations, or expose them to rain. Keep work area well lighted.
5. KEEP CHILDREN AWAY. All visitors should be kept safe distance from work area.
6. MAKE WORKSHOP KID PROOF with padlocks, master switches, or by removing starter keys.
7. DON'T FORCE TOOL. It will do the job better and safer at the rate for which it was designed.
8. USE RIGHT TOOL. Don't force tool or attachment to do a job for which it was not designed.
9. USE PROPER EXTENSION CORD. Make sure your extension cord is in good condition. When using an extension cord, be sure to use one heavy enough to carry the current your product will draw. An undersized cord will cause a drop in line voltage resulting in loss of power and overheating. Table A shows the correct size to use depending on cord length and nameplate ampere rating. If in doubt, use the next heavier gage. The smaller the gage number, the heavier the cord.

Ampere Rating		Volts	Total length of cord in feet			
		120	25	50	100	150
		240	50	100	150	300
More Than	Not More Than		Minimum gage for cord			
0	6		18	16	16	14
6	10		18	16	14	12
10	12		16	16	14	12
12	16		14	12	Not Recommended	

10. WEAR PROPER APPAREL Do not wear loose clothing, gloves, neckties, rings, bracelets, or other jewelry which may get caught in moving parts. Nonslip footwear is recommended. Wear protective hair covering to contain long hair.

11. ALWAYS USE SAFETY GLASSES. Also use face or dust mask if cutting operation is dusty. Everyday eyeglasses only have impact resistant lenses, they are NOT safety glasses.
12. SECURE WORK. Use clamps or a vise to hold work when practical. It's safer than using your hand and it frees both hands to operate tool.
13. DON'T OVERREACH. Keep proper footing and balance at all times.
14. MAINTAIN TOOLS WITH CARE. Keep tools sharp and clean for best and safest performance. Follow instructions for lubricating and changing accessories.
15. DISCONNECT TOOLS before servicing; when changing accessories, such as blades, bits, cutters, and the like.
16. REDUCE THE RISK OF UNINTENTIONAL STATING. Make sure switch is in off position before plugging in.
17. USE RECOMMENDED ACCESSORIES. Consult the owner's manual for recommended accessories. The use of improper accessories may cause risk of injury to persons.
18. NEVER STAND ON TOOL Serious injury could occur if the tool is tipped or if the cutting tool is unintentionally contacted.
19. CHECK DAMAGED PARTS. Before further use of the too., a guard or other part that is damaged should be carefully checked to determine that it will operate properly and perform its intended function - check for alignment of moving parts, binding of moving parts, breakage of parts, mounting, and any other conditions that may affect its operation. A guard or other part that is damaged should be properly repaired or replaced.
20. DIRECTION OF FEED. Feed work into a blade or cutter against the direction of rotation of the blade or cutter only.
21. NEVER LEAVE TOOL RUNNING UNATTENDED. TURN POWER OFF. Don't leave tool until it comes to a complete stop.

Latest Manual

Below is a QR code which will direct you to the latest version of the 25 x 2 manual on the Laguna Tools website. The online manual may have updates and information published after the printed copy was released. Scan the code with your smartphone to be directed to the latest manual.



Main Components



Fig. 1. Main Components.

Setting Up the 25 x 2 sander video & QR code

Below is a QR code which links to a set-up video for the 25 x 2 sander. Scan the QR code with your smartphone to be directed to the video at LagunaTools.com.



UNPACKING The Sander

The sander has been shipped mostly assembled from the factory in a cardboard shroud on a pallet. If any damage has occurred as a result of shipment, notify the transportation company as soon as possible and ask them to make an immediate inspection. Ask for a damage or loss report. Also notify your dealer of any loss or damage during shipment. See Warranty Statement.

Important: To avoid problems and potential damage to the machine, please read through the unpacking instructions below before proceeding to set up the machine in your shop.

1. Unbolt the machine legs from the shipping pallet. Install the leveling feet or optional casters on legs (Fig. 2 & 2A) with a washer(s) and nut(s). Tighten with a 9/16" or 3/4" wrench. The Leveling Feet and mounting hardware are packaged with the machine.

2. Loosen the hex nut and set screws on the table support castings (Fig. 3). The set screws on the table support castings have been tightened at the factory to eliminate free-play between the table support casting and the column tube during shipment. There are two table support castings, one each for the right and left column tubes. **Important:** These set screws are tightened for shipping and must be loosened and readjusted before operating either the height adjustment mechanism or the conveyor drive.

To properly adjust for operation, loosen each set screw by first loosening its hex nut with an open-end wrench and then the set screw with an Allen wrench. Then retighten each set screw with your fingers so it only lightly touches the column tube.

Hold each set screw in position with an Allen wrench and retighten the hex nut. Failure to follow these procedures may result in misalignment of the drum(s) and/or the conveyor table.

Caution: On the SUPERMAX models do not loosen the set screws on the upper drum support castings.

3. If necessary, adjust the tension of the V-belt between the primary motor and driven pulleys. To do this, loosen the two screws in lower belt guard and loosen the pinch bolt located at the back of the motor support casting. Slide the motor support casting down the column tube until the V-belt is taut. Tighten the two screws in lower belt guard. Retighten the motor support pinch bolt.

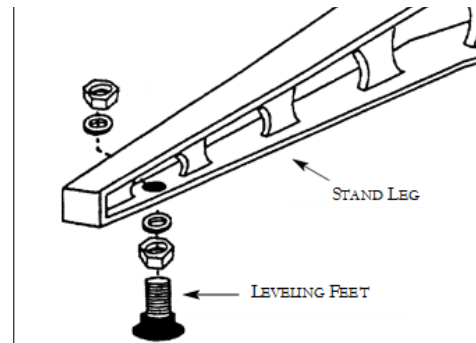

Fig. 2A. Leveling Feet and mounting hardware.



Fig. 2. Caster and mounting hardware.

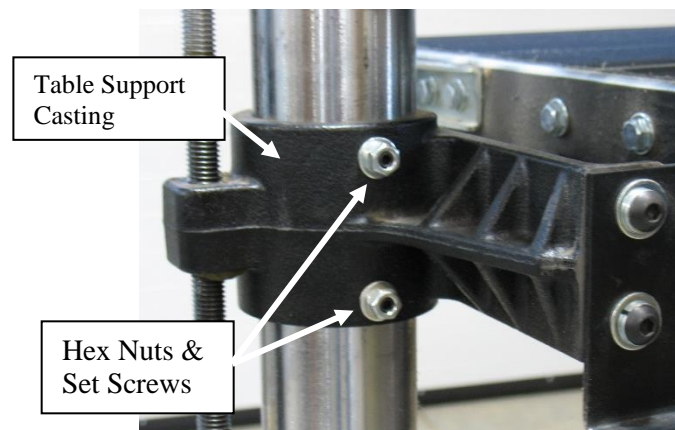

Fig. 3. Table support casting and set screws.

SETTING UP

The drum sander was adjusted and aligned at the factory, and it has been carefully packed for shipment. However, because of possible stress during transit, the unit should be thoroughly checked before use. This section covers the pre-operational checks you should make after unpacking and final assembly. Unnecessary problems can be avoided if these essential checks are performed before operating the sander. Likewise, performing the recommended monthly maintenance procedures listed at the end of this section will help assure trouble-free service.

MAKING ELECTRICAL CONNECTIONS

A cord and plug are not included. Consult with an electrician and confirm all applicable electrical codes before wiring. Please see wiring diagrams for details.

Single Phase: The drum(s) of all SUPERMAX single phase sanders are powered by a 5 HP, 208-230 volt, single phase motor. A plug and cord is not supplied. Single phase SUPERMAX sanders require a minimum dedicated circuit of 10-gauge wire protected by a 30-amp fuse or breaker. Extension cords are not recommended, but if used, should be of at least 10-gauge wire for lengths up to 10' and of at least 8-gauge wire for longer lengths.

Views of junction box (under conveyor motor) with cord installed.

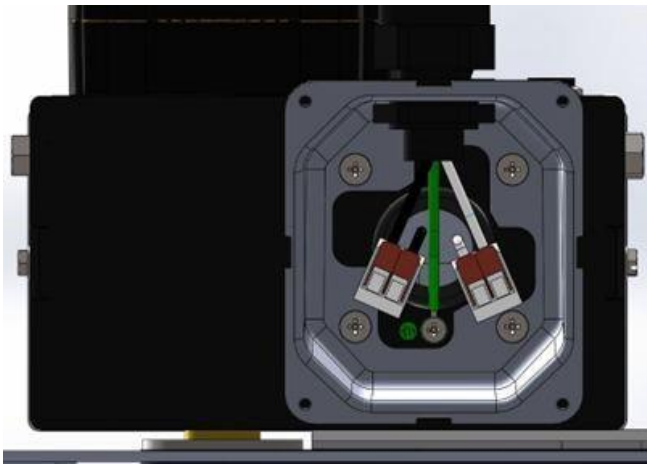

Fig. A. Installed Wiring

Remove the cover of the conduit box, located on the underside of the conveyor motor housing, by removing the screws securing the cover.

1. Loosen (do not remove) the tension nut of the strain relief bushing.
2. Feed the new cord through the strain relief bushing.
3. Attach the first HOT (black) wire to the terminal, by lifting the orange clamp, inserting the bare wire. Press down on the orange clamp to secure wire. Attach the second HOT (red, or white*) in the same manner. See Figs. A & B.

CAUTION: Confirm the wire is secure in the terminal clamp and there is no exposed non-insulated wire!

4. Attach the GROUND (green or green & yellow) to the ground screw of the conduit box. Confirm the wire is secure.
5. Tighten strain relief nut. Confirm the power cord is secure.
6. Confirm all electrical connections are secure and tight. Confirm wires are within conduit box and will not be pinched.
7. Re-attach conduit box cover and secure with screws.

*Follow NEMA/local codes when using "white" as HOT.



Fig. B. Installed Wiring

Note: The Intellisand™ Control (Fig. 5) reduces the chance of potential damage from many overload situations. The conveyor motor for feeding stock is infinitely variable from 0-15 ft/min. If the load on the drum motor reaches its upper limit, the Intellisand Control will automatically slow the feed rate of the conveyor. When the load is decreased on the main motor, the feed rate will automatically increase but never exceed the manual setting on the dial.

CONNECTING DUST COLLECTORS

Dust collection is necessary for all models. The SUPERMAX 37x2 model is equipped with three 4" dust exhaust ports.

To attach the sander to your collection system, install 4" hose from your collector. (See Tips For Maximum Performance). The **minimum** recommended dust collector capacities at the dust ports are: 25x2: 600 CFM. For best results, follow the recommendations of the manufacturer of your dust collection equipment.

CHECKING DRUM ALIGNMENT

The sander was shipped from the factory preadjusted with the drum(s) aligned to the conveyor table. Unless the machine was stressed during shipment, only fine adjustment should be necessary. Minor alignment corrections can be done without relieving V-belt tension or adjusting the tension rollers, but should be done without any abrasive strips attached.



Fig. 4. Checking drum alignment (inboard side).



Fig. 5. Intellisand Controller.

Remove the abrasives from both drums. Using a flat piece of wood or aluminum as a thickness gauge (aka. feeler gauge), insert it between the conveyor table and the primary (front) drum on the left (outboard) side of the machine (see Fig. 4). Raise the table up so the drum just contacts the thickness gauge. Rotate drum by hand to check contact. Then, holding up the front tension roller, check at out-board side of the drum to see that the drum is parallel to the table. If it is not, disengage



Fig. 6. Adjusting primary drum alignment.

the right (inboard) miter gear (see Fig. 6), finely raise or lower the right (inboard) side of the table, using the height adjustment handle, to achieve parallel alignment of the front drum. The distance between the conveyor table and both sides of the front drum should be the same. Reinstall the miter gear, aligning one of the two set screws to the flat of the shaft and tighten both.

Before altering this conveyor table position, also check to see that the rear drum is likewise parallel to the conveyor table, with both sides at the same height above the table. Using the same thickness gauge, check both sides of the rear drum from the back of the machine while holding up the rear tension roller. Adjustment of the rear drum is done by using the right and left drum adjustment knobs (see Fig. 7).

After the rear drum is adjusted, it is important to reset the rear drum adjustment indicators to zero on both sides. To set, loosen the hex nut, then moving the indicator scale so that the zero mark is directly under the pointer, and retightening the hex nut (see Fig. 7). Likewise, zero the indicator for other side of drum. Take care not to overtighten the hex nut of the indicator. This can flare the brass bushing and render the indicator inoperable.

Also check that the secondary drum adjustment knobs turn with a slight resistance to avoid any

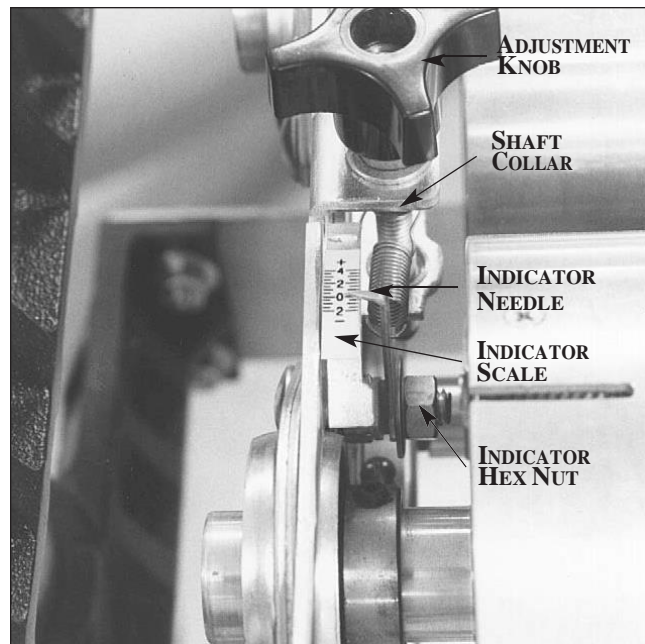

Fig. 7. Rear drum adjustment indicator.

movement during operation. To adjust knob resistance, grip the nut on the threaded stud with a wrench and rotate the knob to remove any backlash in the adjustment stud.

CHECKING CONVEYOR BELT

Conveyor belt tension and tracking adjustments may occasionally be necessary during break-in and normal operation to compensate for belt stretching.

Belt Tension. To adjust the tension of the conveyor belt, first adjust the take-up screw nut (see Fig. 8) on both sides of the conveyor to obtain approximately equal tension on both sides of the belt when taut. Insufficient belt tension will cause slippage of conveyor belt on the drive roller during sanding operation. The conveyor belt is too loose if it can be stopped by hand pressure applied directly to the top of the conveyor belt. Excessive belt tension can

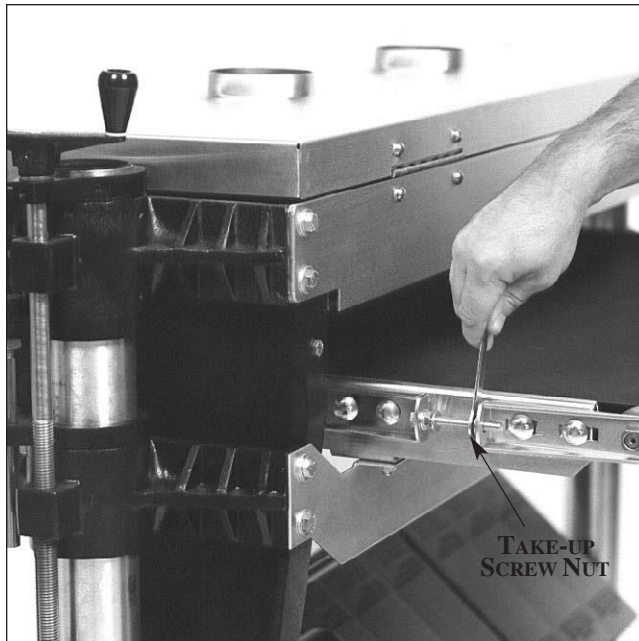

Fig. 8. Adjusting conveyor belt tracking.

result in bent rollers, premature wearing of the bronze bushings or belt.

Belt Tracking. Belt tracking adjustments are made while the conveyor belt is running. After the proper belt tension is obtained (see above), turn the conveyor unit on and set it at the fastest speed setting. Watch for a tendency of the conveyor belt to drift to one side of the conveyor. To adjust the belt tracking, tighten the take-up screw nut (see Fig. 8) on the side the belt is drifting toward, and loosen the take-up screw nut on the opposite side. Adjusting the take-up screw nuts on both sides of the conveyor allows belt tracking adjustments to be made without affecting belt tension. **NOTE:** Adjust the take-up screw nuts only 1/4 turn (or less) at a time. Then allow time for the belt to react to the adjustments before making further adjustments. Make sure wrench is below surface when sanding.

CHECKING TABLE HEIGHT CONTROLS

The depth of cut is controlled by the height adjustment handle (see Fig. 9). Turning the handle raises or lowers both sides of the conveyor table simultaneously by transferring the handle rotation through the miter gear and cross bar assembly.

Important: Before using the height adjustment, be sure to loosen both of the set screws located on the front of both table support castings (see Fig. 3 and Fig. 9) to allow the table support to slide on

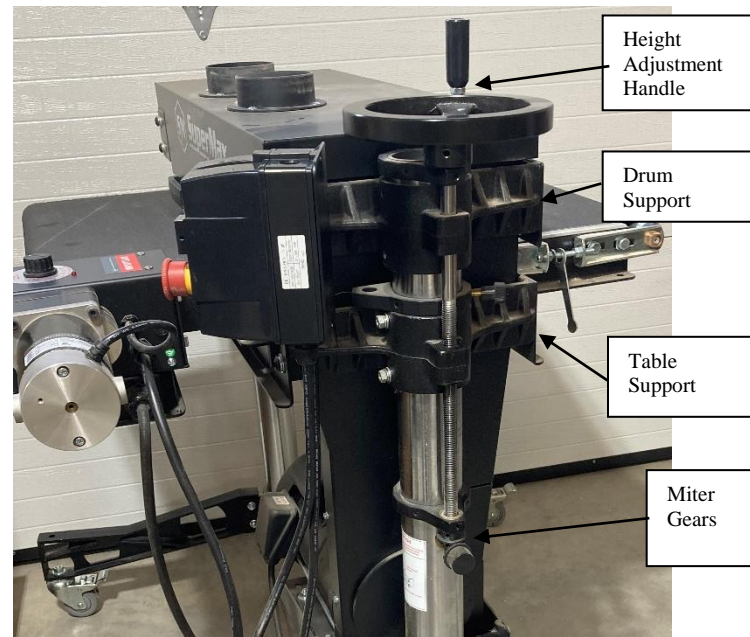

Fig. 9. Table height adjustment.

both column tubes. These set screws are tightened for shipping and must be loosened and readjusted to allow the table support castings to move freely on the column support tubes. Readjust the set screws so they eliminate free-play between the table support casting and the column tube. To properly adjust, tighten the set screws (see Fig. 3) only finger-tight so they lightly touch the column tubes. Then hold each set screw in position with a hex wrench and tighten the nut.

Check the operation of the height adjustment mechanism. If it does not operate smoothly or easily, further adjustments may be necessary. Refer to the servicing section of this manual, for further adjustment procedures.

MONTHLY MAINTENANCE

For best results, perform the following recommended maintenance procedures on a monthly basis:

- Lubricate conveyor bushings and check for wear.
- Lubricate all moving parts, such as threaded rods, washers, and column tubes.
- Clean sawdust from the sandpaper and the conveyor belt.
- Blow dust from the inside of sanding drum(s) and the motors.
- Check all set screws for tightness on parts such as table support castings, bearings, conveyor coupler, castings, pulleys, and miter gears.

INSTALLING ABRASIVE WRAPS

Note: When using Pre-Marked™ or Pre-Cut™ abrasive wraps, not all of the steps below are necessary.

Proper attachment of the abrasive wrap to the drum is critical to achieving top performance from the drum sander. Abrasive wraps do not have to be pre-measured. The end of the roll is first tapered and attached to the left (out-board) side of the drum. Then the wrap is wrapped around the drum, and the second taper is made for attachment to the right (inboard) side of the drum. To attach a wrap to the drum, follow the procedure below.

1. Mark and cut a taper at one end of the roll as shown in Fig. 10a. Because the tapered end should use most of the left (outboard) slot width, its end must be trimmed (Fig. 10-b and 10-c). Raise the clip lever on the left (outboard) side of the drum (Fig. 10-d). Insert the tapered end through the slot and into the fastener so that it uses most of the width of the slot. Release the clip lever to securely hold the strip end in the fastener.

2. Wrap the strip around the drum, being careful not to overlap the windings. The tapered cut of the wrap end should follow the edge of the drum. Continue to wrap the abrasive in a spiral fashion by rotating the drum with your left hand and guiding the strip with your right hand (Fig. 10-e). Successive windings of the strip should be flush with previous windings without any overlap.

3. Mark the trailing end of the wrap where it crosses the right (inboard) end of the drum (Fig. 10-f). From this point, cut a taper as was done with the starting edge of the wrap. (The taper on the remaining roll can be used as the taper for the starting edge of the next wrap to be cut.)

4. With the trailing edge of the wrap properly cut, rewrap the drum and insert the tapered end through the slot in the right (inboard) end of the drum. Insert the tapered end into the inboard take-up fastener. Pull up on the clip lever to open the clip, and pull the take-up lever to the top as shown (Fig. 10-g). After inserting the wrap end, release the clip lever by moving your index finger toward the drum slot. This allows the clip to retain the abrasive while holding the take-up lever in an “up” position.

5. The take-up fastener is designed to automatically take up any slack caused by stretching of the abrasive wrap. **Important: Position the abrasive wrap in the slot with sufficient room between the inside of the slot and the tapered end of the wrap to allow it to be pulled into the drum as needed (Fig. 10-h). Note that not leaving enough space between the wrap and the inside of the slot will prevent the take-up fastener from operating properly.**

6. The abrasive wrap may stretch enough in use to allow the take-up lever to reach its lowest position so it no longer is able to maintain tension on the strip (Fig. 10-i). If this occurs, it will be necessary to reset the take-up lever by raising it, pushing the strip end into the slot, and then releasing the clip lever.

Note: A cleaning stick may be used to remove deposits and help extend abrasive life. To use, operate the sanding drum with the dust cover open. (Caution: For your own safety, always wear eye protection while performing abrasive cleaning, and take all precautions to avoid any contact of hands or clothing with uncovered drums.) Hold the cleaning stick against the rotating drum and move it along the drum surface. It is good procedure to use a shop brush to remove any cleaning stick crumbs from the drums and conveyor.

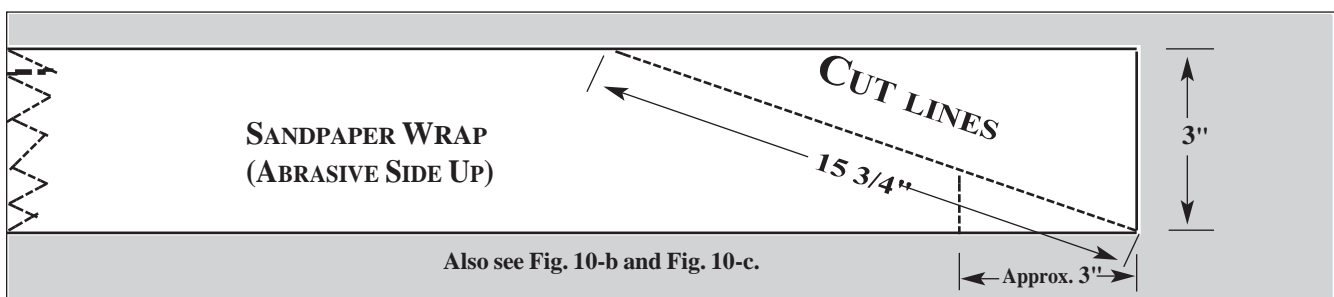

Fig. 10-a. Marking and cutting taper on wrap.

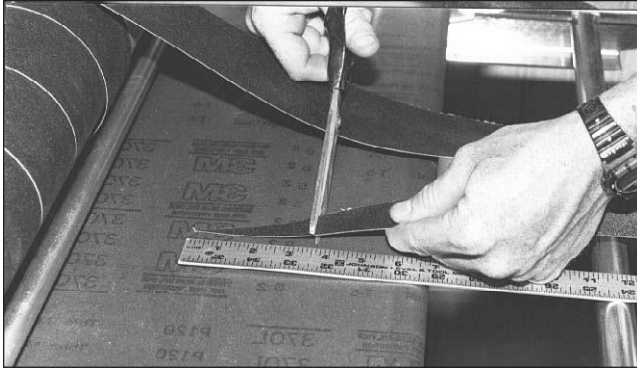

Fig. 10-b. Trim about 3" from end of cut taper.

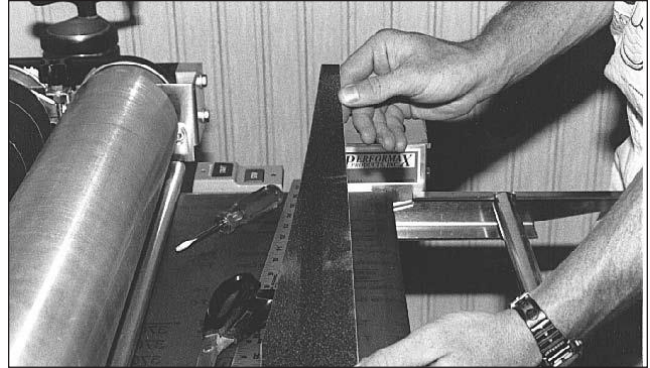

Fig. 10-c. Trimmed tapered end ready to install.

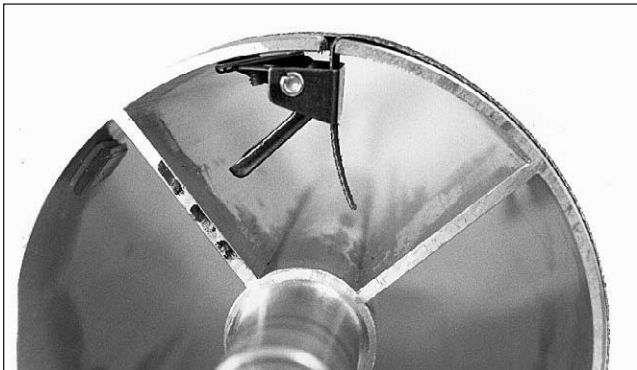

Fig. 10-d. Insert tapered end into outboard slot.

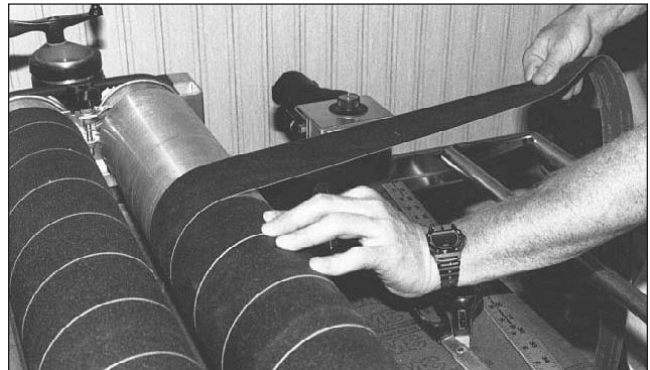

Fig. 10-e. Wrap around drum without overlap.

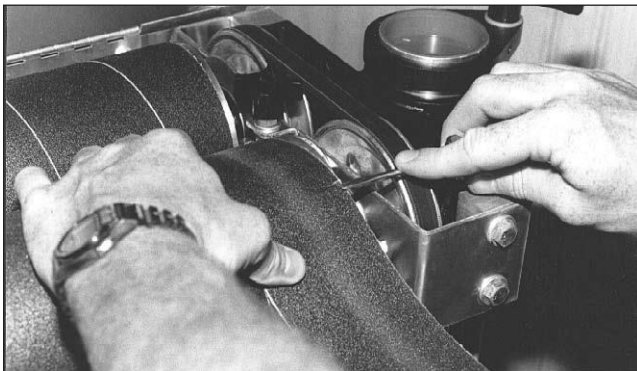

Fig. 10-f. Mark wrap where it crosses drum edge.

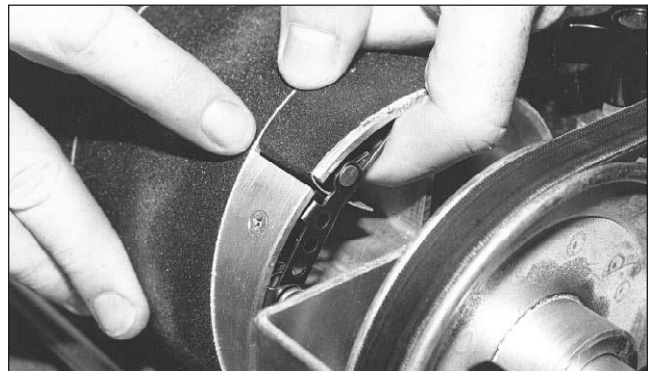

Fig. 10-g. Insert tapered end into inboard slot.

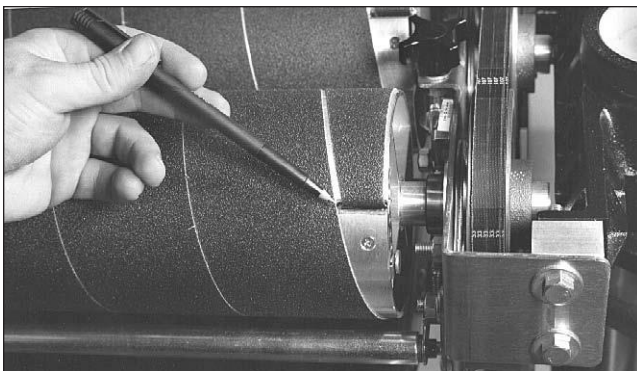

Fig. 10-h. Allow room inside slot for wrap to move.



Fig. 10-i. Reset take-up as needed as wrap stretches.

OPERATING

Before using the drum sander, review the previous pages in this manual on initial set-up and adjustment. In this section, you will learn how to operate the machine. Note that connecting the machine to an adequate dust collection system is necessary before operating the unit.

BASIC OPERATING PROCEDURES

After you have selected and installed abrasive strips, and connected the machine to a dust collection system, you are ready to begin to use the sander. The basic operating procedure for all drum sander models is as follows:

1. Set depth of cut.
2. Start drum(s).
3. Start conveyor and select feed rate.
4. Start dust collector system.
5. Feed stock through unit.

To feed stock, rest and hold the board to be sanded on the conveyor table, allowing the conveyor belt to carry the board into the drums. Once the stock is halfway through, reposition yourself to the outfeed side of the machine to receive and control the board as it exits the unit.

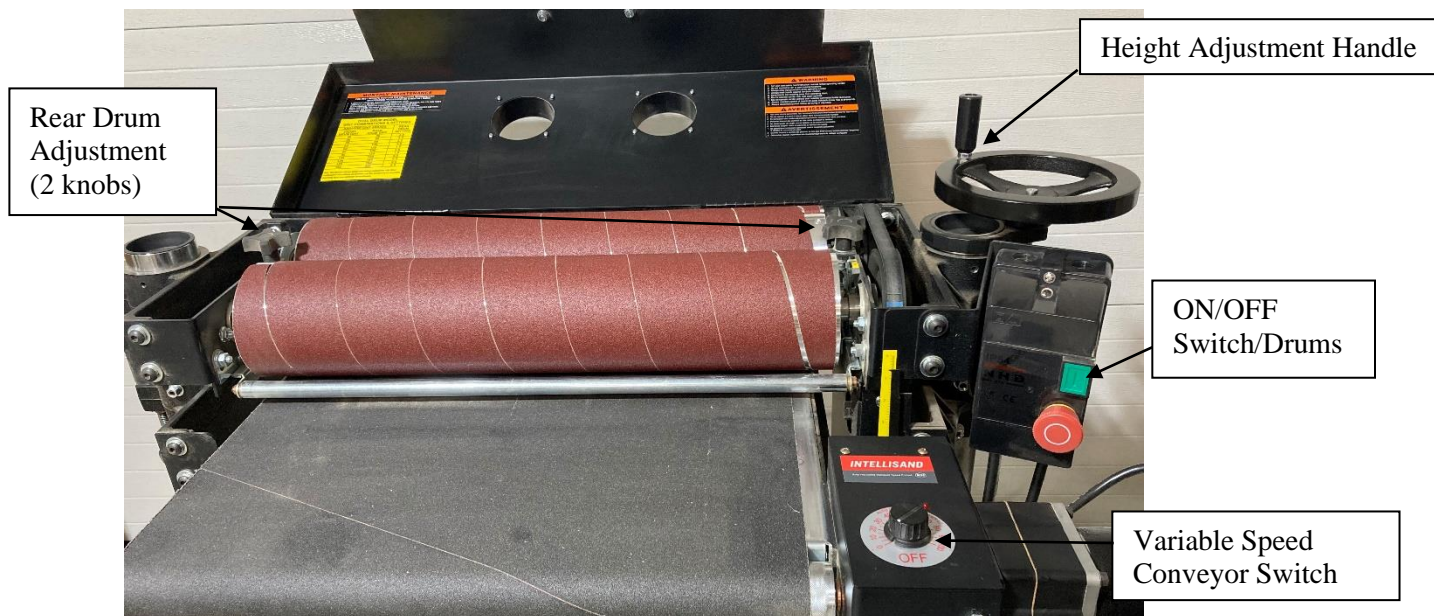

Fig. 11. Operating controls.

SETTING THE DEPTH OF CUT

Adjusting the sander for the proper contact between the abrasive and the stock determines the mechanical depth of cut. **Determining the depth of cut is the most important set-up procedure** before operating the sander. It may take some experimentation to determine the proper depth of cut, given the variables of abrasive grit, type of wood, and feed rate. For best results, use scrap wood to practice sanding and to develop skill and familiarity with the machine before doing finish work.

A good rule of thumb when sanding with grits finer than 80 is to raise the conveyor table so the drum(s) contacts the workpiece but still can be rotated by hand. When using grits coarser than 80 grit, you may be able to raise the conveyor table slightly more. However, a combination of several variables will determine the proper depth of cut to use, including the following:

1. Abrasive type and grit size.
2. Width of the piece being processed.
3. Hardness of the piece.
4. Feed rate of the conveyor belt.

The depth of cut of the primary drum is adjusted by the table height adjustment handle.

The depth of cut of the secondary drum is controlled by the two adjustment knobs (analog indicators) located on both sides of the drum. The drum adjustment knobs allow proper depth of cut with virtually any abrasive grit combinations on the drums. The two drums are typically both used during sanding operations, but either the primary or secondary drum can be used alone.

Front Drum. To adjust the front drum, set the drum height equal to the thickness of the piece to be processed. This is most easily done as follows: Lower the conveyor table to a depth greater than the thickness of the board. **Do not start the drum at this time.**

Start the conveyor and feed the board until it is

beneath the front drum. Raise the conveyor table so the front drum contacts the board but the drum can still be rotated by hand. Continue to run the board through the machine. This is the setting for the first sanding pass.

The depth of cut can be measured on the depth gauge, or by fractions of a revolution of the height adjustment handle. (Note: One revolution of the handle will raise the table $3/32$ of an inch; $1/3$ of a turn will equal $1/32$ of an inch, etc.)

Rear Drum. Sanding with a different abrasive grit on each drum is possible in a single pass. The coarser abrasive is wrapped on the front drum for dimensioning and surfacing of the wood, while the finer abrasive is wrapped on the rear drum. When used in this way, the rear drum generally is positioned just slightly lower than the front drum so it removes the scratches left by the coarser grit on the front drum.

However, the exact depth of cut of the rear drum will depend on the specific abrasive grits on each of the drums.

The chart shows grit combinations and rear drum settings, can also be found under the dust cover of your machine. It suggests settings for various abrasive grit combinations; try these to start and make adjustments as necessary for your work. When adjusting the rear drum, turn

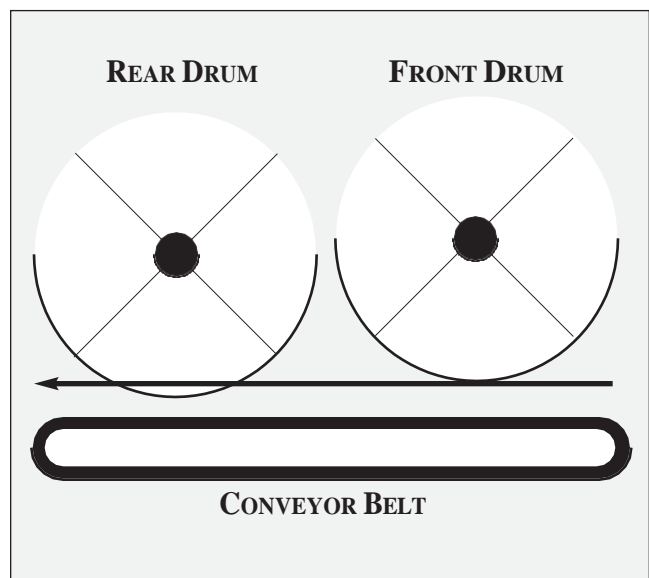

Fig. 12. Relative positions of dual drums.

DUAL DRUM GRIT COMBINATIONS & SETTINGS

<u>ABRASIVE GRIT GRADES</u>		
FRONT DRUM GRIT	REAR DRUM GRIT	REAR DRUM SETTING
36	36	2.0
36	60	2.5
36	80	2.5
60	80	2.0
60	100	1.5
80	100	1.0
80	120	1.0
100	150	0.5
120	150	0.5
120	180	0.5
150	220	0.5

Note: The grit and settings shown are starting suggestions only. Other combinations and settings are possible, depending on your particular circumstances.

both adjustment knobs so that the indicator needles move to the desired setting at the plus (+) end of the scale. The depth of cut of the rear drum should be rechecked each time a different grit combination is used.

Fine-tuning the rear drum settings can help improve performance. Here is a quick way: Raise the rear drum so it is higher than the front drum, with the indicators showing a -3 setting. Place the stock to be sanded under the front drum. Then raise the conveyor table so the front drum contacts the wood, but still can be rotated by hand. Sand the piece with the front drum and stop the machine. Then insert the stock in from the back so it is under the rear drum only. Lower the rear drum using the adjustment knobs on each side. Lower the rear drum until it contacts the stock but still can be rotated by hand. Use this setting, and note the readings on the depth indicators for future reference.

DISENGAGING THE DRUMS

On dual drum models, either the primary (front) or rear drum may be disengaged so that the other drum can be used alone. To use the front

drum as a single-drum sander, disengage the rear drum by raising it to the -2 setting on the indicators on both sides. To use the rear drum alone, lower it to the +4 setting on both sides. In this mode, the table height adjustment handle is used to determine the depth of cut, which will be limited to about 1/32 of an inch before the front drum starts contacting the work piece.

SELECTING INTELLISAND FEED RATES

Selecting the proper feed rate is essential to proper finish sanding. The variable feed rate control of the conveyor belt adjusts the load on the machine; it can be infinitely adjusted for maximum operating performance. A faster feed rate allows faster sanding but fewer revolutions of the drums per inch of sanding. A slower feed rate provides more revolutions of the drum per inch of sanding to allow a greater depth of cut and smoother sanding.

The Intellisand control (See Fig. 13) continuously monitors the load on the drum motor and automatically regulates the speed of the conveyor motor to maintain the highest feed rate without overload. If the load on the drum motor increases, the Intellisand control will decrease the conveyor feed rate and will stop the conveyor under extreme conditions. If the load on the drum decreases, the Intellisand control will increase the feed rate but WILL NOT increase it faster than the manual setting on the switch dial.

For abrasive planing and thicknessing, the feed rate can be set at any speed after adjusting for the proper depth of cut. If the load on the drum motor approaches its limit, due to inconsistent stock, the feed rate will automatically slow down. As the load on the drum motor decreases, the feed rate will automatically increase to its original setting.

When finish sanding with grits finer than 80, the best finish will be achieved if the conveyor does not change speeds during operation. While the Intellisand control will slow the feed rate when the main motor reaches its limit, it is advisable to operate below the regulation point. When the red indicator light comes on, the Intellisand control has detected too great a depth of cut and/or too fast a feed rate. This change in conveyor speed may leave a detectable mark on finish surfaces. If a mark is visible, make adjustments by slowing conveyor and/or lessening the depth of cut and run the stock through again.

Begin experimenting with the feed rate set at about 40% to 50% of maximum. The best feed rate will depend on a number of factors, including type of stock, grit and depth of cut used, and whether the stock is feed directly in line with the conveyor bed or at an angle. If you observe a ripple effect on the stock, slow down the feed rate. If the finish is smooth and the machine is not overworking, you can experiment with using a faster feed rate.

Also try a faster feed rate if the stock you are working begins to show burn marks. With cherry, hard maple and some other hardwoods, using a shallower depth of cut and a faster feed rate will help minimize burn marks. Slightly angling the stock as it is fed into the machine may also help prevent burning the stock.

Because of the wide range of variables, it is important to experiment with your specific conditions and make adjustments to achieve the optimum feed rate. If problems occur, first check the depth of cut and/or adjust the feed rate. Refer to **Troubleshooting Your SUPERMAX** in this manual.

USING THE DEPTH GAUGE

The depth gauge measures the distance between the conveyor table and the sanding drum for thickness dimensioning. To calibrate the depth gauge, raise the conveyor table until the drum(s), wrapped with abrasive, touches the con-



Fig. 13. Intellisand Controller and depth gauge.

veyor table. Make sure the indicator is pointing at “zero”. If not, loosen the two screws at the bottom of the indicator and slide indicator until pointing at “zero”. Tighten the two screws of the indicator.

USING THE Electronic DEPTH GAUGE (EDG)/Digital Read Out (DRO)

The depth gauge has its own manual. The EDG can be calibrated by raising the conveyor until the drum(s) are touching the conveyor and zero the readout. Another calibration method is to sand a piece of wood, measuring the thickness of the wood and change the reading on the readout. See EDG manual for details on calibrating and operation.

USING THE DEPTH STOP

A depth stop is located on the column tube just above the tale support casting on the right (inboard) side. The depth stop casting has a locking knob located on one side of the casting. To operate the depth-stop: Determine desired thickness of sanded part by either referencing the depth gauge or sanding a part and measuring the thickness of the sanded part. At this sanding thickness, position the depth-stop along the column tube with the gauge resting on the table support casting and tighten the locking knob on the depth stop. This will give the desired thickness to the material and help prevent under-dimensioning.

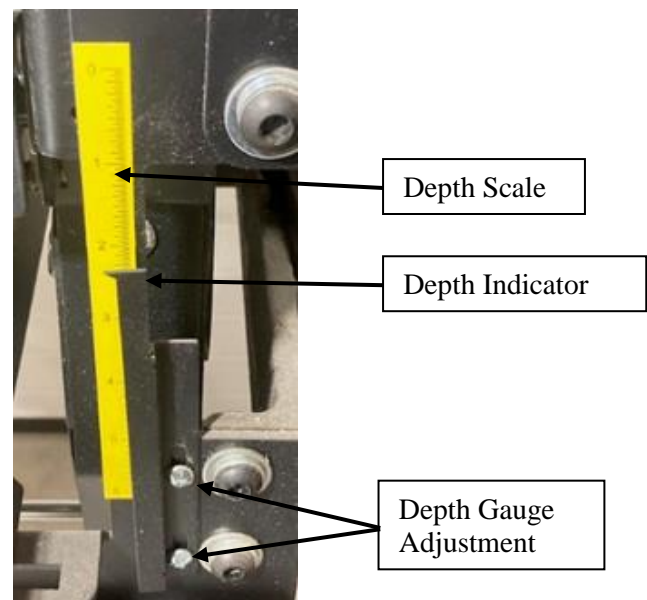

Fig. 14. Depth gauge components.

SELECTING DRUM ABRASIVES

It is important to select the proper grit of abrasives for the type of sanding being performed to achieve maximum sanding results. As with any sanding operation, first begin sanding with a coarser grit, depending on the roughness of the stock or the amount of stock to be removed. Then progressively work toward finer grits. The chart below shows the general uses for the various grits. Performax Products offers abrasives in the ten different grits shown.

Selecting Abrasive Grits. The amount of stock to be removed is a major consideration when choosing the grit grade to start with. Grits 24, 36, 50, and 60 are primarily designed for stock removal. Grits 24 and 36 will remove the most material in one pass, whether you are doing abrasive planing, cleaning up glued panels, or flattening stock. Grits from 100 through 220 are primarily finishing grits designed to remove the scratch pattern from the previous grit used. For best results, never skip more than one grit grade when progressing through a sanding sequence.

For fine work, such as furniture, try not to skip any grit grades during the sanding process. In general, premium quality abrasives such as genuine SuperMax abrasives will produce a better finish

with a less noticeable scratch pattern. **Caution:** Grits that are too fine can sometimes burnish the wood and leave a glossy surface which will not accept stains evenly. This will vary by type of wood. Oak, for example, is susceptible to burnishing because of its open pores.

Selecting Grit Combinations. The chart shown is a general guide to consult when selecting grits to use on dual drum machines and setting the rear drum. This chart is also provided under the dust cover on the SUPERMAX for quick reference. The first column suggests grits for the primary (front) drum of dual drum models, while the second column suggests a corresponding grit to use on the second (rear) drum. The third column suggests depth settings to try on the rear drum, depending on the grit used. The setting values are based on a “0” reading when the drum contacts the work piece but still can be rotated by hand.

Note that the grits and settings are starting suggestions only. Other combinations and settings are possible, depending on your particular circumstances. It is a good idea to keep records of the combinations you use and their results. Keeping these records handy will help you select the best combinations of grits for future work.

ABRASIVE SELECTION GUIDE

<u>GRIT</u>	<u>COMMON APPLICATION</u>
24 Grit	Abrasive planing, surfacing rough-sawn boards, maximum stock removal, glue removal.
36 Grit	Abrasive planing, surfacing rough-sawn boards, maximum stock removal, glue removal.
50 Grit	Surfacing and dimensioning boards, trueing warped boards.
60 Grit	Surfacing and dimensioning boards, trueing warped boards.
80 Grit	Light dimensioning, removal of planer ripples.
100 Grit	Light surfacing, removal of planer ripples.
120 Grit	Light surfacing, minimal stock removal.
150 Grit	Finish sanding, minimal stock removal.
180 Grit	Finish sanding only, not for stock removal.
220 Grit	Finish sanding only, not for stock removal.

TIPS FOR MAXIMUM PERFORMANCE

The versatility designed into the SUPERMAX drum sander allows it to be used for a wide-ranging variety of tasks that will boost the return on your investment. For example, its capabilities range from taking the place of a planer to thickness rough stock, all the way to speeding up fine sanding work often done with slower, dust-generating hand sanders.

Learning to use its multiple adjustments and controls will allow you to fine-tune the machine for maximum results, regardless of the job to be done. The best results come from experimenting with different abrasive combinations and machine adjustments to fit the job at hand. Following is a listing of useful tips which can help you improve performance of your sander.

Dust Collection. When connecting dust collectors, remember that straight pipe will not restrict airflow as much as flexible tubing. Also, Ys and elbows will restrict airflow less than Ts. When connecting to the ports of the 37x2, use a larger diameter pipe to the machine, and then split to 4" hoses connected to the ports. An alternative is to use separate 4" lines running to the ports; **do not** use only one 4" line and split it by the machine.

Multiple-Piece Sanding Runs. When abrasive planing (or thickness sanding) a run of similar pieces that you want to have the same thickness, it is best to determine the thickness of the thinnest piece and process all pieces to that same thickness. Be aware that the sander will remove cups and crowns in the work piece; consider this when measuring and processing stock to the same thickness.

Sanding Multiple Pieces. When sanding multiple pieces simultaneously, make sure to stagger (step) the pieces across the width of the conveyor belt. This provides better contact with the tension rollers. Try to only process multiple pieces of similar thickness. If there is a significant thickness difference, the thinner pieces can slip on the conveyor belt when they do not contact the tension rollers. Also note that pieces thicker than 3/4" should be longer than the minimum normally recommended to prevent tipping of the stock (see Specifications). Going to longer pieces is especially important when sanding boxes or other tall, short or light stock.

Edge Sanding. When edge sanding, the sander will mimic the opposite edge of the stock which is laying on the conveyor belt. Because of this, it is important for the stock edge to have been ripped or jointed at the proper angle to the face before the sanding process. When edge sanding stock that is less than 3/4" wide, or more than 2" high, it is good procedure to stack and clamp several pieces together to prevent them from slipping or tipping on the conveyor belt.

Sanding Imperfect Stock. When sanding stock with a cup or crown, place the crown up. This will stabilize the stock to help prevent tipping or rocking during sanding. (After the crown has been removed and the top is flat, turn the stock over and sand the opposite side.) To avoid personal injury, take special care when sanding stock that is twisted, bowed, or otherwise varies in thickness from end to end. If possible, support such stock as it is being sanded to keep it from slipping or tipping. Use extra roller stands, help from another person, or hand pressure on the stock, to minimize potentially hazardous situations.

Face Frames & Raised Panel Doors. It is very important to have the proper abrasive contact when doing this type of sanding. If the machine is set to take an excessive depth of cut, the result can be a gouge or dip as the drum goes from sanding the rails at full width to sanding just a few inches of width on the stiles. To prevent this, make sure that when using abrasives finer than 80 grit the drum is in contact with the wood but can still be spun by hand. If there is room, angling the stock on the conveyor belt can also help. Slowing the conveyor feed when coming to a rail in the stock can help prevent a dip or gouge. This allows the abrasive to work the wider width with less effort, and to achieve better consistency of the finished surface.

Stock Feeding Angle. Some pieces, because of their dimensions, will need to be fed into the machine at a 90° angle (perpendicular to the

drums). However, even a slight offset angle of the stock will provide for more effective stock removal. The optimum feeding angle for stock removal is about 60°. Angling the workpiece for stock removal provides other advantages, such as less loading of certain areas of the drums due to glue lines or mineral streaks in the stock, more even wear of abrasive strips, potentially faster feed rates, and lighter loads on the motor.

Note that to get the best final finish, however, the stock should be fed through the machine so it will be sanded in line with the grain of the wood on the final one or two passes.

Cleaning Abrasive Strips. Regularly clean the abrasive strips on the drums with commercially available cleaning sticks, following the manufacturer's directions. Cleaning sticks are available from your dealer. When cleaning, also brush the stick crumbs from the drum while it is still rotating and from the conveyor belt. **Important:** Wear eye protection, tight-fitting clothes and keep alert during this operation to avoid injury. Cloth-backed abrasives can be cleaned by soaking in paint thinner or mineral spirits for 20 minutes to 1 hour, then using a brush to remove any build-up or burns. Dry the abrasive strips completely before reuse. In some cases build-ups resulting from burns can be removed with Plexiglas held on edge

over a rotating drum. Have dust collection turned on when cleaning.

Stretching Abrasive Life. When sanding metal or solid surface, MDF, or particle board, ceramic and zirconium abrasive tend to last longer than aluminum oxide and allow a more uniform finish.

Abrasive life can also be increased by removing the abrasive wrap from the drum and reversing it. To do this, remove the wrap and use what was the trailing end as the starting end on the left (outboard) side of the drum.

Reversing the wrap will provide a fresh set of cutting edges on the drum.

Keeping The Machine Clean. For best results, make cleaning the machine a regular shop procedure. Allowing excess build-up of dust and debris can adversely affect performance through the loading of the abrasives, slippage on the conveyor table, and/or the accumulation of material inside the drums which can throw off the center of balance. Leave the dust collector on when cleaning dust from the drums. Also brush the conveyor belt after cleaning operations. If not cleaned, the conveyor belt could allow stock to slip during sanding operations.



Fig. 15. Offset stock feeding angle.

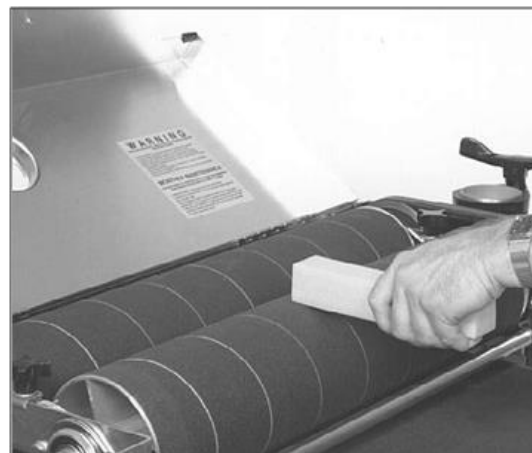

Fig. 16. Cleaning abrasive strips.

TROUBLESHOOTING

Any operating problems with the drum sander will likely occur most often during the period that you are becoming familiar with its components and their adjustments. If you are experiencing a problem affecting the machine's

sanding performance, check the following listings for potential causes and solutions; it may also pay to review the previous sections in this manual on setting up and operating your machine.

TROUBLESHOOTING GUIDE: MOTORS

Problem	Possible Cause	Solution
Motors do not start.	<ol style="list-style-type: none"> 1. Main power cord unplugged from receptacle. 2. Circuit fuse blown or circuit breaker tripped. 	<p>Plug in primary power cord.</p> <p>Replace fuse or reset breaker (after determining cause).</p>
Drum motor overloads.	<ol style="list-style-type: none"> 1. Inadequate circuit. 2. Machine overloaded. 	<p>Check electrical requirements.</p> <p>Use slower feed rate and/or reduce depth of cut.</p>
Conveyor motor oscillates.	<ol style="list-style-type: none"> 1. Motor not properly aligned. 2. Shaft collar worn. 3. Drive roller bent. 	<p>Loosen housing bolts, run motor, retighten bolts.</p> <p>Replace shaft collar.</p> <p>Replace drive roller.</p>
Drum motor or conveyor gear motor stalls.	<ol style="list-style-type: none"> 1. Excessive depth of cut. 	<p>Reduce depth of cut; reduce feed rate.</p>

TROUBLESHOOTING GUIDE: MACHINE

Problem	Possible Cause	Solution
Abrasive strip comes off drum.	1. Slack in abrasive strip on drum.	Remove slack in strip.
	2. Abrasive improperly installed.	Read section on abrasive installation.
Abrasive strip loose.	1. Strip caught on inside edge of slot or on inboard side of drum.	Readjust strip end in slot and/or trim abrasive edge.
	2. Strip not cut properly.	Recut and install abrasive strip.
Abrasive loads up prematurely.	1. Excessive depth of cut.	Reduce depth of cut.
	2. Excessive feed rate.	Use slower feed rate.
	3. Inadequate dust collection.	Increase air flow at dust ports.
	4. Inadequate abrasive.	Use open-coat abrasive.
	5. Stock fed at 90° angle to drum.	Angle stock to avoid resin line build-up.
Conveyor rollers run intermittently.	1. Shaft coupling loose.	Align shaft flats of gear motor and drive roller, and tighten shaft coupling setscrews.
Conveyor belt slips on drive roller.	1. Improper conveyor belt tension.	Adjust belt tension.
	2. Excessive depth of cut.	Reduce depth of cut; reduce feed rate.
Board slips on conveyor belt.	1. Excessive depth of cut.	Reduce depth of cut.
	2. Tension rollers too high.	Lower tension rollers.
	3. Excessive feed rate.	Reduce feed rate.
	4. Dirty or worn conveyor belt.	Clean or replace conveyor belt.

TROUBLESHOOTING GUIDE: MACHINE (Continued)

Problem	Possible Cause	Solution
Conveyor belt tracks to one side, or oscillates from side to side.	1. Belt out of adjustment.	Readjust belt.
	2. Drive or driven conveyor belt rollers misaligned.	Readjust.
	3. Conveyor table not flat and square.	Readjust by leveling with leg glides.
	4. Conveyor belt worn or defective.	Replace conveyor belt.
	5. Roller bushings elongated due to excessive wear.	Replace bushings.
Table height adjustment works improperly.	1. Improper adjustment of height control.	Readjust height control.
Drum drive belt slips.	1. Improper V-belt tension.	Increase drive belt tension.

TROUBLESHOOTING GUIDE: OPERATIONS

Problem	Possible Cause	Solution
Rippled sanded surface (non-uniform ripples).	1. Uneven feed rate.	<p>Check for these conditions and refer to previous section, Troubleshooting: Machine.</p> <ul style="list-style-type: none"> • See Selecting Intellisand Feed Rates. • Conveyor belt slipping on drive roller. • Board slipping on conveyor belt. • Conveyor gear motor stalling. • Excessive V-belt tension. • Set screw loose on shaft coupler between gear motor and conveyor, tighten. • Conveyor bushings dry; lubricate.
Rippled sanded surface (uniformly spaced ripples).	<p>1. Excessive feed rate.</p> <p>2. Excessive depth of cut.</p> <p>3. Sander vibration.</p>	<p>Reduce depth of cut or reduce feed rate</p> <p>Reduce depth of cut or reduce feed rate.</p> <p>Check for these conditions:</p> <ul style="list-style-type: none"> • Loose bolts or bearing and pulley set screws; retighten. • Dirty drum; clean inside. • Excessive V-belt tension; reduce tension. • Worn V-belt; replace. • Worn driven pulley, replace.

TROUBLESHOOTING GUIDE: OPERATIONS (Continued)		
Problem	Possible Cause	Solution
Sniping of wood (gouging near end of board).	<ol style="list-style-type: none"> 1. Tension rollers set too far down. 2. Stock not supported properly during infeed or outfeed. 3. Conveyor drive or driven rollers higher than conveyor bed. 	<p>Reset tension rollers.</p> <p>Support stock with roller stands, tables or benches.</p> <p>Readjust rollers.</p>
Burning of wood.	<ol style="list-style-type: none"> 1. Feed rate too slow. 2. Excessive depth of cut for grit used. 3. Excess build-up on abrasive strips. 4. Abrasive is too fine. 5. Abrasive strips overlapped. 6. Drum out of alignment. 	<p>Increase feed rate.</p> <p>Reduce depth of cut or increase grit coarseness.</p> <p>Reduce depth of cut; clean strips or replace.</p> <p>Replace with abrasive of coarser grit.</p> <p>Rewrap strip without overlap.</p> <p>Realign drum.</p>
Gouging of wood.	<ol style="list-style-type: none"> 1. Conveyor belt is too loose. 2. Excessive depth of cut. 3. Wood slipping on conveyor due to lack of contact. 4. Abrasive is too fine. 	<p>Adjust belt tension.</p> <p>Reduce depth of cut.</p> <p>Use alternate feeding procedure.</p> <p>Replace with coarser grit.</p>
Unsanded ridge along length of piece (abrasive appears clean).	<ol style="list-style-type: none"> 1. Grit has been removed from backing. 	<p>Avoid this area of drum, or change abrasive wraps.</p>

SERVICING

The basic adjustment procedures for your machine are covered under Setting Up Your Sander. Review that section first. If following the general instructions does not solve a specific problem or result in smooth operation, also check Troubleshooting Your SUPERMAX. Below are suggested procedures to follow when more thorough readjustment or replacement is necessary.

ADJUSTING HEIGHT CONTROLS

Height adjustment problems may be the result of not loosening the set screws in the table support castings before attempting operation. If the set screws were not loosened as instructed, do so now before proceeding further. Also make sure all moving parts of the height adjusting mechanism are well lubricated, including the miter gears, column tubes, and threaded height adjusting screws.

When troubleshooting the height adjustment mechanism, first check the conveyor table for level. Then test the height adjustment mechanism (See Fig. 17). If it does not operate

easily, further adjustments may be necessary, as outlined below. Following these steps should result in smooth operation.

Readjustment Procedure

1. Loosen the set screws located at the front of the table support castings (Fig. 17).
2. Lubricate thoroughly by applying penetrating lubricant to the table support castings where they contact the column tubes, and to all contact points of adjusting screws and cross bar (Fig. 18). Also apply oil or grease to the miter gears.
3. If the height adjustment feels stiff, check for misalignment of adjusting screw supports and the drum support castings which could cause binding on the adjusting screw rods (Fig. 17). These castings can be adjusted by loosening the set screws which secure them to the column tubes. Realign the adjusting screw supports by loosening the two set screws that hold them to the column tubes and rotate to the proper position.
4. The adjusting screw supports located immediately below the height adjustment handle and the

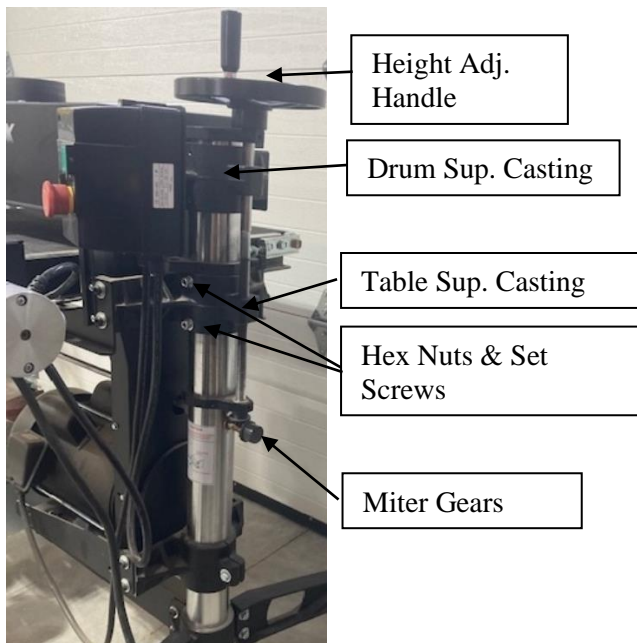

Fig. 17. Table support casting set screws.

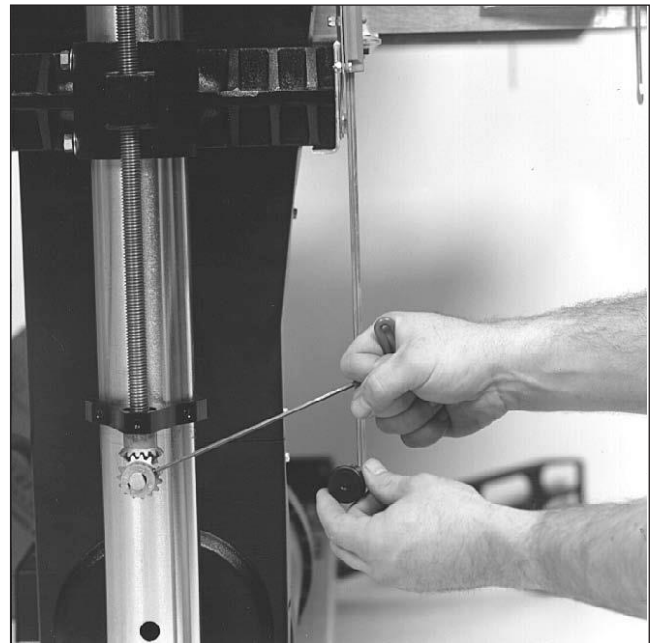

Fig. 18. Adjusting miter gears for proper mesh.

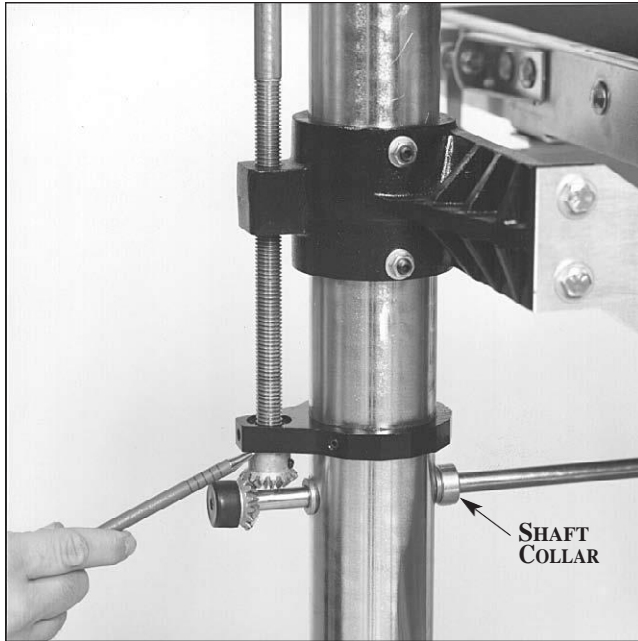

Fig. 19. Miter gear below adjusting screw support.

left (outboard) drum supporting casting (Fig. 17) must both be set at the proper height along the column tubes so the height adjusting screws provide for proper miter gear alignment. Before adjusting these parts, tighten one set screw in the table support castings (Fig. 17) to hold the height adjusting screw in position during adjustment.

Also check to see that the column tubes are centered inside the bore of the table support castings (Fig. 17). If not, loosen the casting bolts and tighten the set screws at the front of table support casting to center the tube. Retighten the bolts and loosen the set screws.

5. If the height adjustment mechanism feels rough, check the miter gear (Fig. 18) alignment. The miter gears can be adjusted on their shafts by loosening the set screws on the gears. Check and adjust so that the gear mesh is not too tight or too loose, and that the gear teeth align with the opposing gear. Note that the shaft collars located on the cross bar (Fig. 19) should be adjusted to control the lateral movement of the cross bar to maintain accurate miter gear alignment and mesh.

The mesh of the miter gears should be smooth and even. If not, adjust the gears for good mesh (Fig. 18). Measure the space between the miter gear and the adjusting screw support that holds the height adjusting screw in place (Fig. 19). The

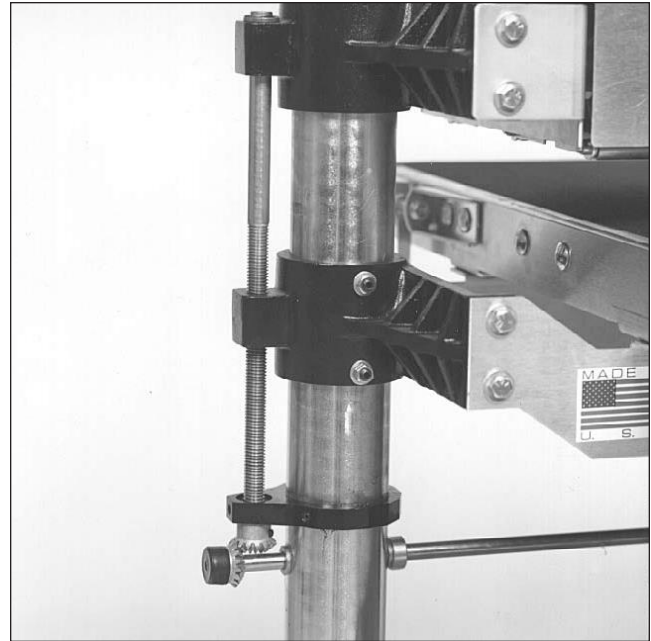

Fig. 20. Height controls on outboard side.

distance should be $1/32$ " or less. If there is excessive space, move the adjusting screw support to the proper distance above the miter gear and retighten. Loosen the set screws in the table support castings (Fig. 17) and test for smooth operation.

6. Next, check the position of the height adjusting screw rods. First raise the conveyor table. Then check the E-clip and washer at the top of the height adjusting screw on the left (outboard) side, and under the height adjustment handle on the right (inboard) side of the machine. On both sides, the washer and E-clip (or washer only) should be snug on the casting just below the washer. If there is a space between the washer and the casting, tighten one set screw in each of the table support castings. If one height adjusting screw is loose, remove the miter gear from the cross bar on that side. Turn down the threaded height adjusting screw rod until it is snug with the washer. Make sure both sides are snug on top. Reinstall the miter gear and tighten. Loosen the set screws in the table support castings and test for smooth operation.

ADJUSTING TABLE SUPPORT CASTINGS

If the conveyor table does not raise and lower easily, measure the distance between the top of the base column support and the bottom of the table

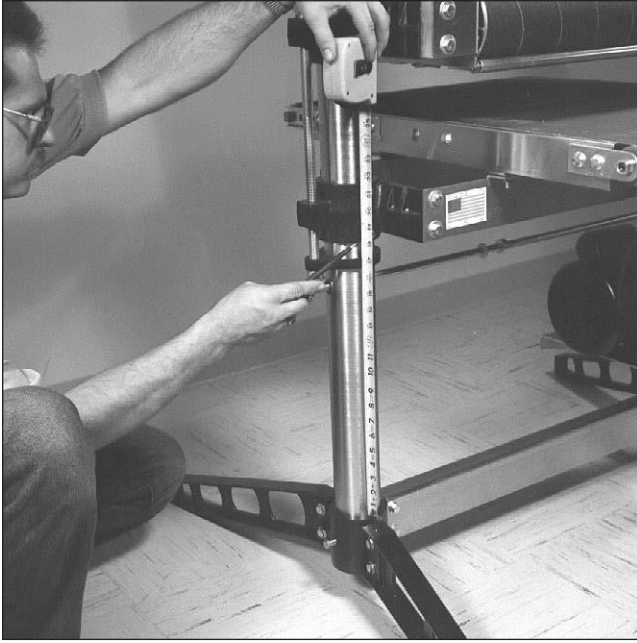

Fig. 21. Adjusting table support castings.

support casting (Fig. 21) on both the right (inboard) side and the left (outboard) side of the machine. Compare these measurements; they should be within 1/16". If not, disengage the miter gear on the right (inboard) side of the cross bar. Adjust the conveyor bed height using the height adjustment handle to get the same measurement on both sides. Then re-engage the miter gear on the cross bar.

If the conveyor table is still difficult to raise or lower, the table support castings may need to be recentered on the column tubes. To do this, loosen the bolts in each table support casting, adjust and tighten the set screws to hold the casting in position. Then tighten the hex head bolts and loosen the set screws.

ADJUSTING SANDING DRUMS

After any adjustments of the castings on the columns, check to make sure the sanding drums are in alignment. To begin realignment of the sanding drums, first remove the abrasive strip from the drum. Release the V-belt tension from the motor by loosening the pinch bolt of the motor support casting.

Loosen two screws in lower belt guard. Slide the motor mount up the column tube and retighten the pinch bolt. After the feed table has been leveled, loosen all four tension roller suspension bolts



Fig. 22. Comparing drum support casting heights.

(see Fig. 26). Raise the tension roller suspension assembly to its highest position so that the tension rollers are positioned higher than the bottom of sanding drum(s). Then retighten the four tension roller suspension bolts to hold the tension rollers in that position during drum alignment.

Primary Drum Alignment. Using a flat piece of wood or a steel rule as a thickness gauge, insert it between table and primary (front) drum and adjust the table height to gauge the thickness. Raise the table just so the drum can be barely turned by hand. Measure at both sides of the drum to check that the primary drum is parallel to the table. To adjust the primary drum alignment, loosen both set screws at the front of the right (inboard) drum support casting (Fig. 22) and raise or lower the casting on the column tube to correct drum alignment. Retighten the set screws and recheck the alignment. **Note:** Do not loosen the set screws of the left (outboard) drum casting as this will cause miter gear misalignment.

Achieving a very precise primary drum alignment can be accomplished by disengaging the right (inboard) miter gear (Fig. 23) from the height adjustment cross bar, and using the height adjustment handle to finely raise or lower the inboard side of the table to achieve parallel align-

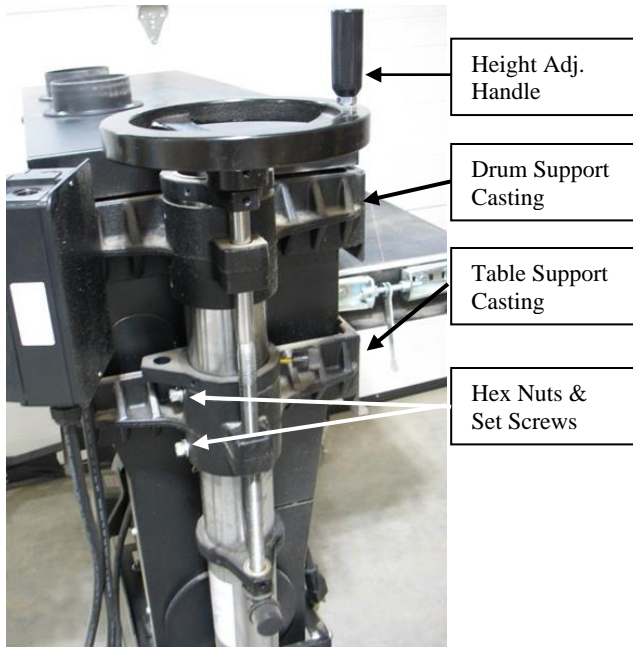

Fig. 23. Adjusting primary drum.

ment of the drum (see **Adjusting Table Level**). Note that if only fine adjustment of the primary drum alignment is required, these adjustment procedures can be used to correct alignment without relieving V-belt tension or adjusting tension rollers as described above.

The above procedure is all that is required to align the drum on a single drum SUPERMAX sander. If yours is a dual drum machine, follow the procedure below.

Secondary Drum Alignment. With the primary drum properly aligned, use the same thickness gauge and insert it between the secondary drum and the table from the back side of the machine. (Again, adjust the contact between the drum and guide so the drum can barely be turned by hand.) Measure at both sides of the drum to check that the secondary drum is parallel to the table. To adjust the secondary drum alignment, use the right and left drum adjustment knobs (Fig. 25) to raise or lower each side of the drum.

At this point both the primary and secondary drums will be aligned parallel to the table and both drums will be at the same height above the table. Set the secondary drum adjustment indicators by loosening the hex nut (Fig. 25), moving the scale so that the zero mark is directly under the needle, and retightening the hex nut. Zero the indicator for

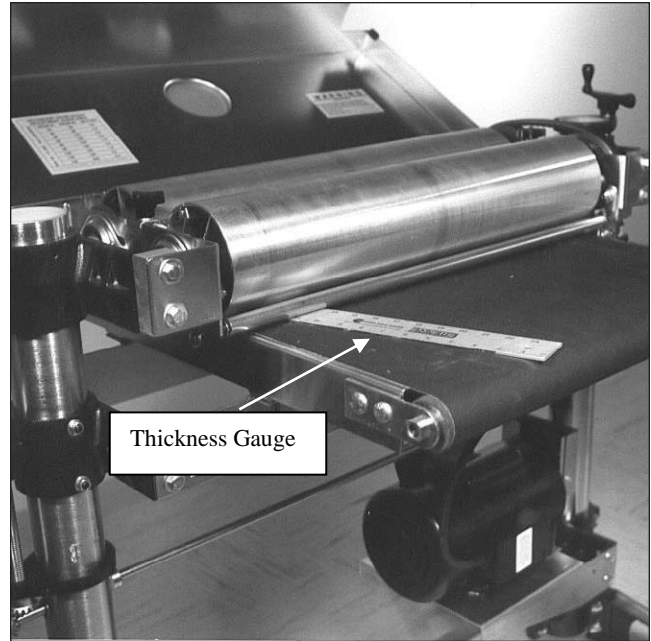

Fig. 24. Using thickness gauge during alignment.

other side of drum in the same manner.

Caution: Do not overtighten the hex nut of the indicator (Fig. 25). This can flare the brass bushing and render the indicator inoperable. Also, the secondary drum adjustment knobs should turn with a slight resistance to avoid any movement during operation.

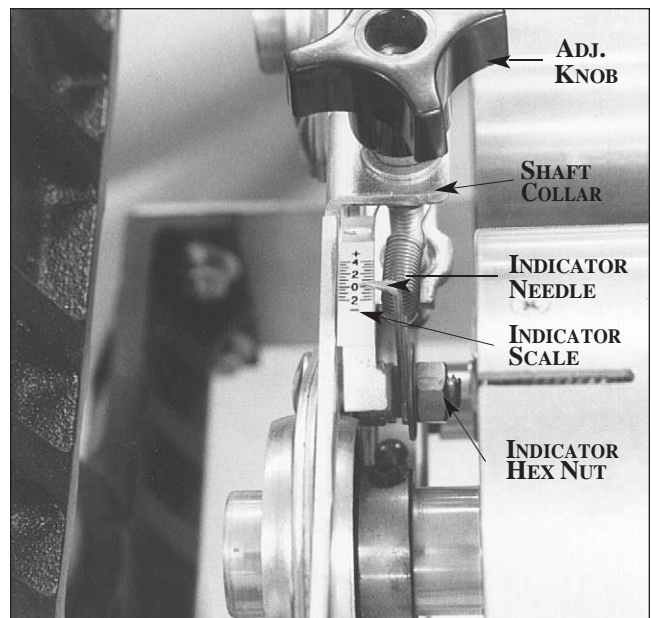

Fig. 25. Secondary drum adjustment indicator.

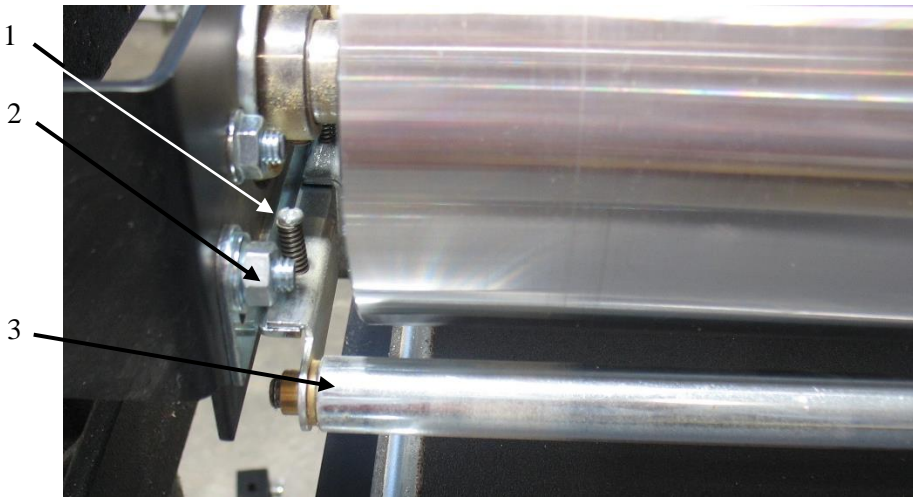

Fig. 26. Tension roller adjustment.

- 1. Spring Retaining Screws.**
- 2. Tension Roller Suspension Bolts.**
- 3. Tension Roller.**

Note: The nut of the rear bolt on the rear (secondary) drum bearing bracket should be backed off a quarter-turn from being fully tightened. This allows the lock washer under the rear bolt on the rear bracket to be depressed slightly, but not completely. After alignment is completed, lower the motor mount to re-establish V-belt tension. Tighten two screws in belt guard.

ADJUSTING TENSION ROLLERS

With the sanding drums properly aligned, raise the table to the bottom of the sanding drums. Loosen all four tension roller suspension bolts (see Fig. 26). Lower the table by one full turn of the height adjustment handle. At this position the tension roller assembly should be resting on the table with the drums suspended slightly above the table. Then retighten the tension roller suspension bolts.

Note: Too much tension roller pressure can cause snipe marks which are identified as a visible line running across the width of the board approximately 2 1/4" from the end of the board. If a snipe mark occurs on the trailing end of the board, adjust the infeed tension roller. Tension roller pres-

sure can be adjusted two ways, either by loosening the spring retaining screws (see 1, Fig. 26) or by raising the height of the tension rollers. To adjust the tension rollers to eliminate snipe marks, use this two-step procedure:

Step 1. With the sanding drums properly aligned, loosen all four tension roller suspension bolts. Raise the table to the bottom of the sanding drum(s). The tension rollers should be resting firmly on the conveyor bed. Tighten only the two rear (outfeed) tension roller suspension bolts.

Step 2. Lower the conveyor table by one full turn of the height adjustment handle. At this point, press down on the front (infeed) tension roller so it is resting on the table. Now tighten the front (infeed) tension roller suspension bolts. If there still is a snipe mark left on pieces being sanded, repeat Step 1 and Step 2, but in Step 2 lower the conveyor bed a half turn instead of a full turn.

Warning: Improperly adjusted tension rollers (i.e., those set too high, rendering them non-functional) could allow kick-back/slippage of pieces being sanded.

REPLACING CONVEYOR BELT

To replace the conveyor belt, the conveyor assembly must be removed from the machine. Lower the conveyor table to its lowest position with the height adjustment handle. Remove the bottom cover from control box, rotate shaft to access set screws in shaft coupler. **Important: Disconnect power to sander!** Loosen two set screws from shaft coupler, (@90°). Remove the four bolts holding the conveyor motor control box base bracket (Fig. 29). Remove conveyor motor control box and place on dust cover or separate stand. Loosen the conveyor take-up screws (Fig. 27 and Fig. 28) to relieve belt tension and slide the driven roller fully inward. Remove the four bolts that attach the conveyor assembly to the table mount brackets (see Fig. 28). Lift the conveyor and remove it from the machine by sliding the conveyor out, toward the front of the machine. Avoid tearing the belt on any edges underneath the conveyor bed during removal. Reverse the procedure for re-installation.

Note: If the conveyor belt continually tracks to one side of the machine, first try reversing the belt on the conveyor bed. If this doesn't remedy the problem, place a level on the conveyor bed to make sure the conveyor bed is not twisted. If squaring up the bed does not remedy the problem, proceed with the following steps:

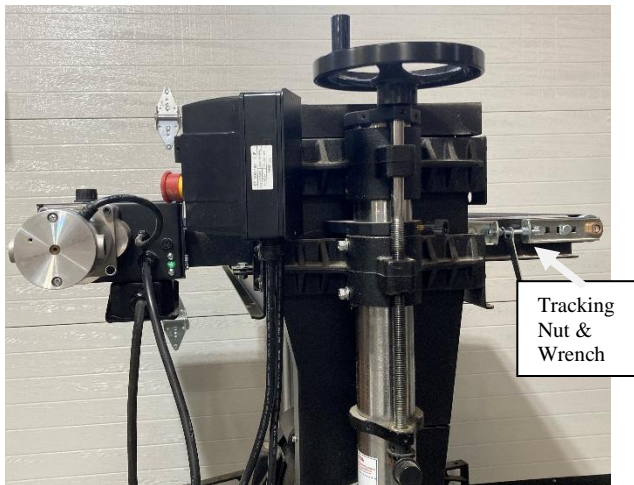

Fig. 27. Conveyor belt replacement

Step 1. Check the conveyor drive and driven roller to make sure they are parallel to the surface of the conveyor bed. To do this, first center the conveyor belt on the bed. Then lay a straight-edge on the exposed edge of the conveyor table on the left (out-board) side, extending it over the drive roller, then driven roller. Note the distance between the drive roller then driven roller and the straight-edge.

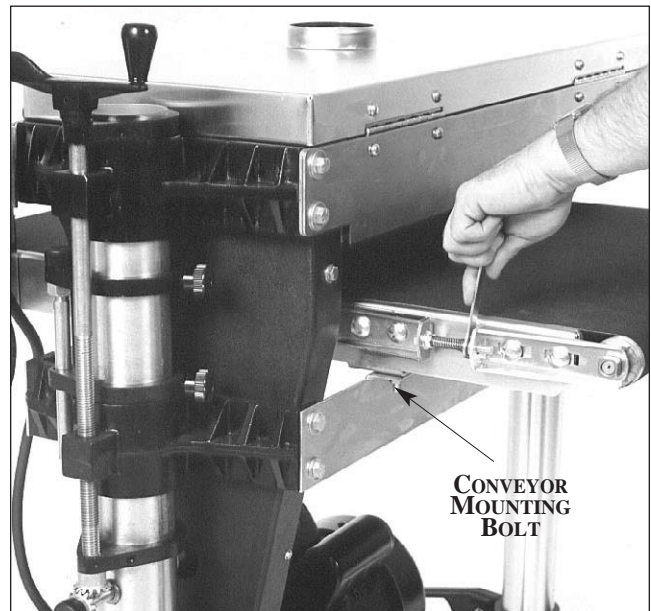

Fig. 28. Tensioning and tracking conveyor belt.

Step 2. Now repeat Step 1 on the right (inboard) side of the conveyor. Compare the measurements from side to side. If they are not equal, loosen one of the brackets that hold the drive or driven roller in place. Tip this bracket until the distance between the drive or driven roller and the straight-edge are equal from side to side, then tighten the bracket.

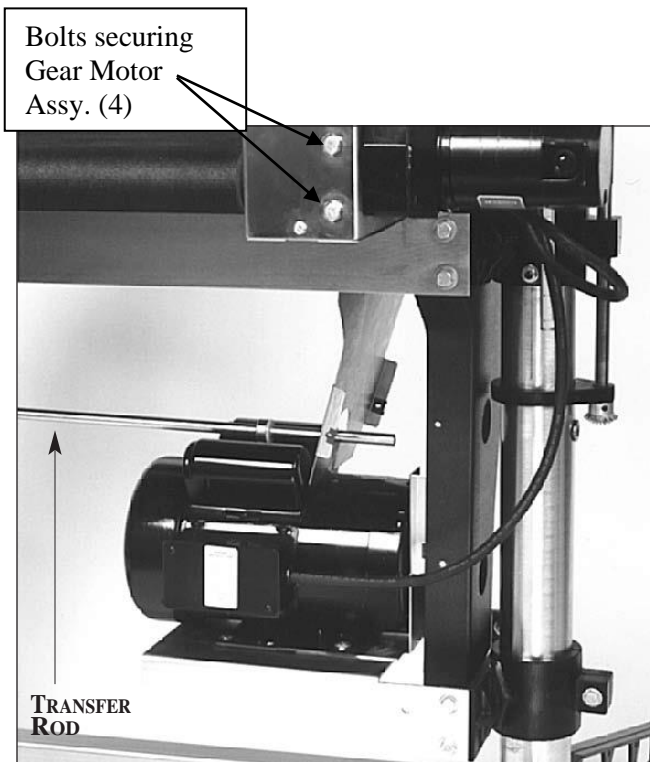

Fig. 29. Removing belt guard and transfer rod.

REPLACING V-BELT

To change the V-belt on the SUPERMAX, first unplug machine from the outlet.

V-Belt Removal

1. Remove the outer belt cover by removing the screws and bolts holding it in place. Pull the middle cover to the left. Take the V-belt off the pulley.
2. Loosen the pinch bolt of the motor support casting, raise the motor, and re-tighten pinch bolt.
3. Remove the miter gear from the right (inboard) side of the transfer rod. Loosen the shaft collar on the left (outboard) side of the rod and pull the rod back enough so the V-belt can be removed. Note the routing of the old V-belt; now remove the old V-belt and replace it with the new V-belt.



Fig. 30. Removing main motor V-belt drive.

Machine Reassembly

1. To reassemble the unit after replacing the V-belt, first place the transfer rod back through the machine. Tighten the shaft collar. Reinstall the miter gear on the transfer rod, making sure the set screw is centered on the flat of the rod.
2. Adjust the tension on the V-belt by sliding the motor down and then tightening the pinch bolt in the motor support casting. Adjust so the belt deflects about 1/2" between the pulleys when pressed. Excessive tension can increase motor load and decrease bearing life, while a loose belt can reduce operating efficiency and shorten belt life.
3. Reinstall the outer and middle belt guard using the screws and bolts.
4. Make sure that the pulleys are in alignment by holding a straightedge across their flat sides and adjusting to it. Also check that all bolts are tight before using the sander.



Fig. 31. Conveyor control box (Intellisand) and on/off switch.

REPLACING ELECTRICAL COMPONENTS

To replace either the variable-speed Intellisand control, the on-off switch, or the conveyor motor, use the following disassembly procedure (Fig. 31).

First disconnect the power supply to the

machine. Next, remove the bottom plate from the control box. Loosen the set screws in the shaft coupler, and remove the four bolts holding the conveyor motor assembly in place (Fig. 31). Remove the assembly from the machine and turn it upside down to disconnect the leads from the components to be removed.

To replace the Intellisand control: remove the knob by loosening the small screw and remove nut that was under knob. Turn housing over, and remove the nuts holding control board in place. Lift control board from housing. Install the new controller, referring to the correct electrical diagram and reverse the disassembly procedure.

To replace the on-off switch: remove the two screws holding cover in place. Disconnect wire leads from switch. Referring to the electrical diagram, reverse the disassembly procedure.

To replace the gear motor: disconnect the three wire leads. Disconnect the strain-relief protecting the wires passing through the sheet metal. Then remove the four set screws that hold the motor to the bracket. Remove the old motor and install the new motor. Referring to the correct electrical diagram, reverse the disassembly procedure.

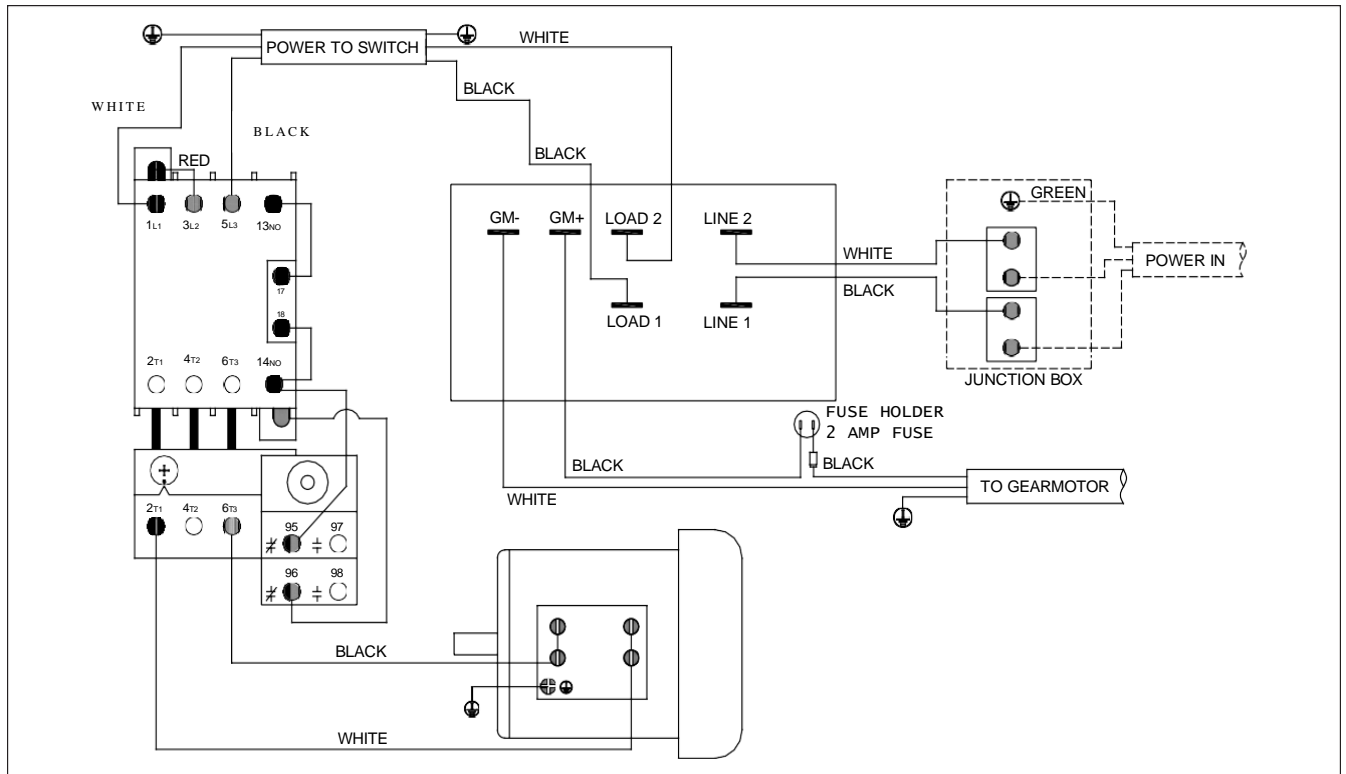

Wiring Diagram, 220 volt, single phase.

STAND ASSEMBLY PARTS LIST

Ref #	Description	Part #	Qty.
1	HEIGHT ADJUSTMENT HANDWHEEL	31-0027	1
2	SET SCREW, 1/4"-20X1/4"	480BS-113	11
3	OILITE WASHER, 5/8" I.D.	50-3080	1
4	CAP, PLASTIC COLUMN TUBE, 3"	80-4015	2
5	SUPPORT, ADJUSTING SCREW, W/BEARING	30-1112-0	3
6	SET SCREW, 1/4"-20X3/8"	PLAREVO1836-1119	9
7	SET SCREW, 5/16"-18X3/8"	10-2903	4
8	PLASTIC CAP, 1"	80-4013	2
9	SCREW, 3/16"-24x3/8"	913002-109	2
10	DEPTH GAUGE POINTER	40-1102	1
11	DEPTH GAUGE SCALE	40-1101	1
12	DRUM SUPPORT CASTING	30-5206	2
13	SUPPORT, ADJUSTING SCREW	30-1112	2
14	SUPPORT, OUTBOARD TABLE	30-5204	1
15	HEX NUT, 5/16"-18	12-0003	4
16	FLAT WASHER, 5/16"	11-0206	4
17	BRASS TIPPED SET SCREW, 5/16"-18X3/4"	10-9906	4
18	KNOB, LOCKING W/SET SCREW	81-3132W	2
19	SUPPORT, INBOARD TABLE	30-5205	1
20	BRACKET, TABLE MOUNT	40-0025	2
21	BUTTON HEAD SOCKET SCREW, 3/8"-16X1-1/4"	913002-121	16
22	FLAT WASHER, 3/8"	11-9103	25
23	FLANGE LOCK NUT, 3/8"-16	12-0209	24
24	INBOARD HEIGHT ADJ. SCREW	30-1212	1
25	MITER GEAR	20-1101	4
26	ROUND OILITE BUSHING, 1/2" I.D.	50-3107	4
27	COLUMN TUBE	30-1236	2
28	SET SCREW, 1/2"-13X1/2"	10-8905	2
29	SHAFT COLLAR, 1/2" I.D.	20-1103	2
30	TRANSFER ROD	30-3033-02	1
31	MOTOR MOUNT	40-0106	1

Ref #	Description	Part #	Qty.
32	MOTOR SUPPORT CASTING	30-5107	1
33	HEX CAP SCREW, 3/8"-16X1-1/2"	10-9207	9
34	LEG	30-1105	4
35	BASE, COLUMN	30-1101-1	2
36	LEVELING FEET	20-0655	4
37	HEX NUT, 3/8"-16	12-005	8
38	BASE SUPPORT BRACKET	40-0230	1
39	RETAINING RING, E12	20-0752	1
40	OUTBOARD HEIGHT ADJ. SCREW	30-1211	1
41	BEARING, R8ZZ	BB-R8ZZ	3
42	KNOB	913002-142	1
44	E-RING, E10	635DS-139	1
45	SPRING WASHER, 3/8"	480BS-111	28
46	NYLON WASHER, 10X16X2	91267-145	1

STAND ASSEMBLY

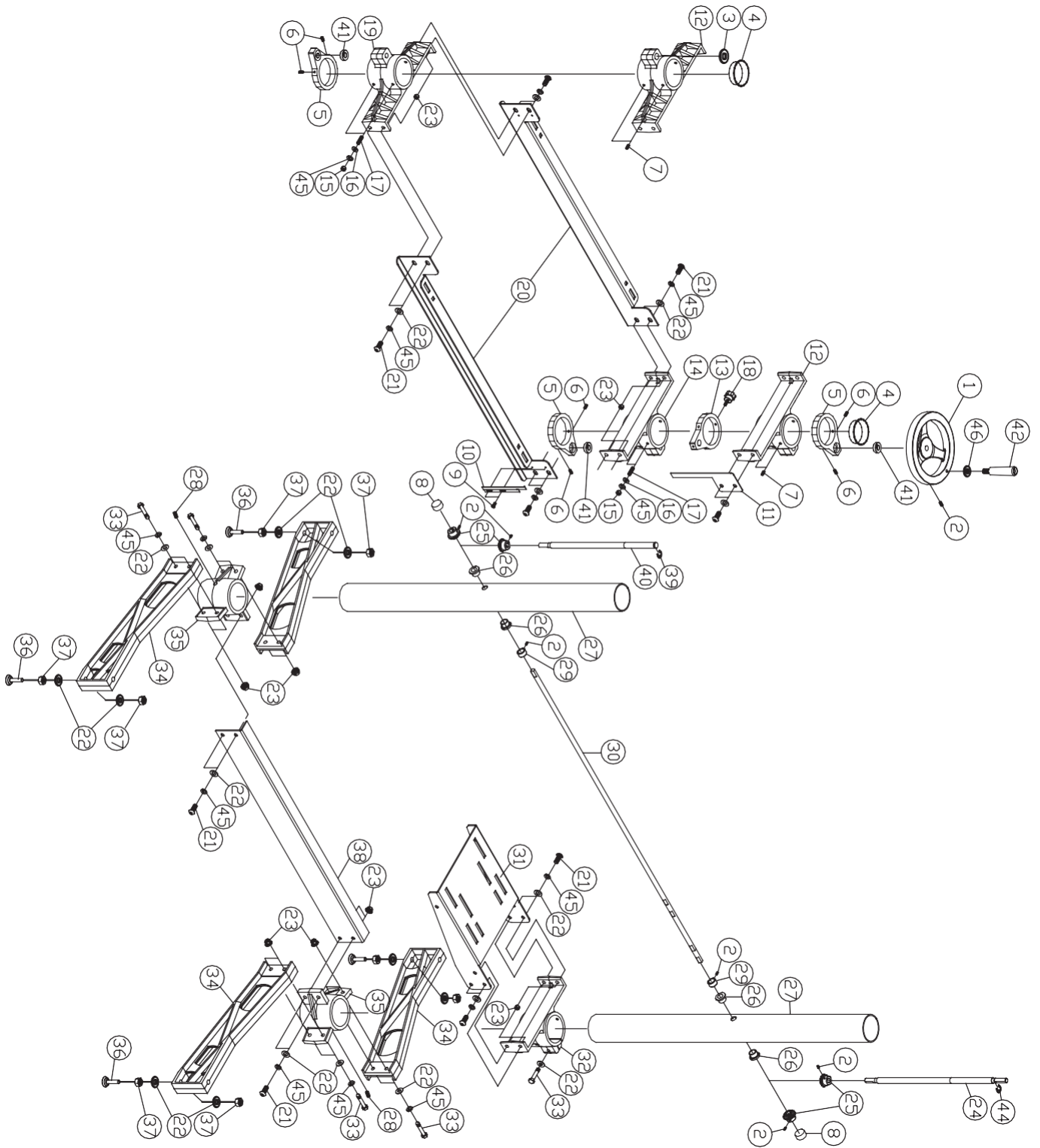

DUAL DRUM HEAD ASSEMBLY PARTS LIST

Ref #	Description	Part #	Qty.
1	DUST COVER	40-1525A	1
2	HANDLE, DUST COVER	80-2841	1
3	SCREW, 5/16"-18X5/8"	913002-203	2
4	SCREW, 1/4"-20X1/2"	10-3205	8
5	LOCK-INT. TOOTH WASHER, 1/4"	11-0504	8
6	DUST COVER MOUNT	40-0240	1
7	HINGE	40-0225	2
8	FLAT WASHER, 1/4"	11-0205	8
9	HEX NUT, 1/4"-20	12-0001	8
10	BUTTON HEAD SOCKET SCREW, 3/8"-16X1-1/4"	913002-121	8
11	FLAT WASHER, 3/8"	480BS-129	8
12	FLANGE LOCK NUT, 3/8"-16	12-0209	8
13	SET SCREW (BEARING), 1/4"-28UNFX1/4"	10-8602	8
14	CARRIAGE BOLT, 5/16"-18X1"	10-1204	6
15	HEX CAP SCREW, 5/16"-18X1-1/4"	10-9106	2
16	FLAT WASHER, 5/16"	11-0206	10
17	SPACER, 5/16" I.D.	30-1305	2
18	BEARING	50-3067	4
19	OUTBOARD DRUM MOUNT BRACKET	40-0519	1
20	HEX NUT, 5/16"-18	12-0003	6
21	SECONDARY DRUM ADJ. KNOB	80-3135	2
22	NYLON INSERT LOCK NUT, 5/16"-24UNF	635DS-249	2
23	OUTBOARD SECONDARY DRUM ADJ. BRACKET	40-0527	1
24	LOCK WASHER, 5/16"	11-0010	2
25	OUTBOARD SECONDARY DRUM INDICATOR	95-1659	1
26	BRASS SPACER	30-1303	2
27	SPRING WASHER, 3/8"	20-1165	2
28	EXTENSION SPRING	20-3210	2
29	KEY, 1/4"X1/4"X1"	20-0762	2
30	OUTBOARD INDICATOR NEEDLE	40-0531	1
31	OUTBOARD ABRASIVE FASTENER	21-1173	2
32	SCREW, #6-32X3/8"	10-3003	4
33	SANDING DRUM, 25"	30-1200	2
34	INBOARD ABRASIVE FASTENER	21-1172	2

Ref #	Description	Part #	Qty.
35	INBOARD INDICATOR NEEDLE	40-0530	1
36	INBOARD SECONDARY DRUM INDICATOR	95-1660	1
37	INBOARD SECONDARY DRUM ADJ. BRACKET	40-0526	1
38	SPECIAL BOLT	913002-238	1
39	SCREW, 1/4"-20X3/8"	635DS-135	12
40	INBOARD DRUM MOUNT BRACKET	40-0520	1
41	DUST PORT	635DS-210	3
42	SPACER, 1" I.D.	30-1304	1
43	IDLER PULLEY	50-1258A	1
44	SPRING WASHER, M3	480DS-134	4
45	BEARING, 6001ZZ	BB-6001ZZ	2
46	HEX NUT, 7/16"-14	913002-246	1
47	DRIVEN PULLEY	50-0502	2
48	SCREW, 5/16"-18X1/2"	913002-248	2
49	BELT GUARD COVER	80-1028A	1
50	PHILLIPS FILLISTER HEAD SCREW, #8-32X1"	10-3107	6
51	COMPRESSION SPRING	20-3268	6
52	CARRIAGE BOLT, 5/16"-18X3/4"	10-1203	4
53	FLAT WASHER, 3/16"	913002-253	2
54	TENSION ROLLER BASE BRACKET	40-0306	2
55	TENSION ROLLER SUSPENSION BRACKET, RIGHT	40-0302	3
56	TENSION ROLLER SUSPENSION BRACKET, LEFT	40-0303	3
57	OILITE BUSHING, 5/16" I.D.	50-3105	6
58	TENSION ROLLER	30-1205	3
59	MIDDLE INNER BELT GUARD	40-1028A	1
60	NYLON INSERT LOCK NUT, M3X0.5	480DS-138	4
61	SLOTTED HEX HEAD SCREW, #10-24X3/8"	10-3803	2
62	FLANGE LOCK NUT, 5/16"-18	12-0207	8
63	PULLEY, SET SCREW, 5/16"-18X3/8"	10-8903	4
64	HEX CAP SCREW, 3/16"-24X1/2"	913002-264	2
65	HEX NUT, 3/16"-24	913002-265	2
66	SPRING WASHER, 3/8"	480BS-111	8
67	BUMPER, DUST COVE	80-1035	2

DUAL DRUM HEAD ASSEMBLY

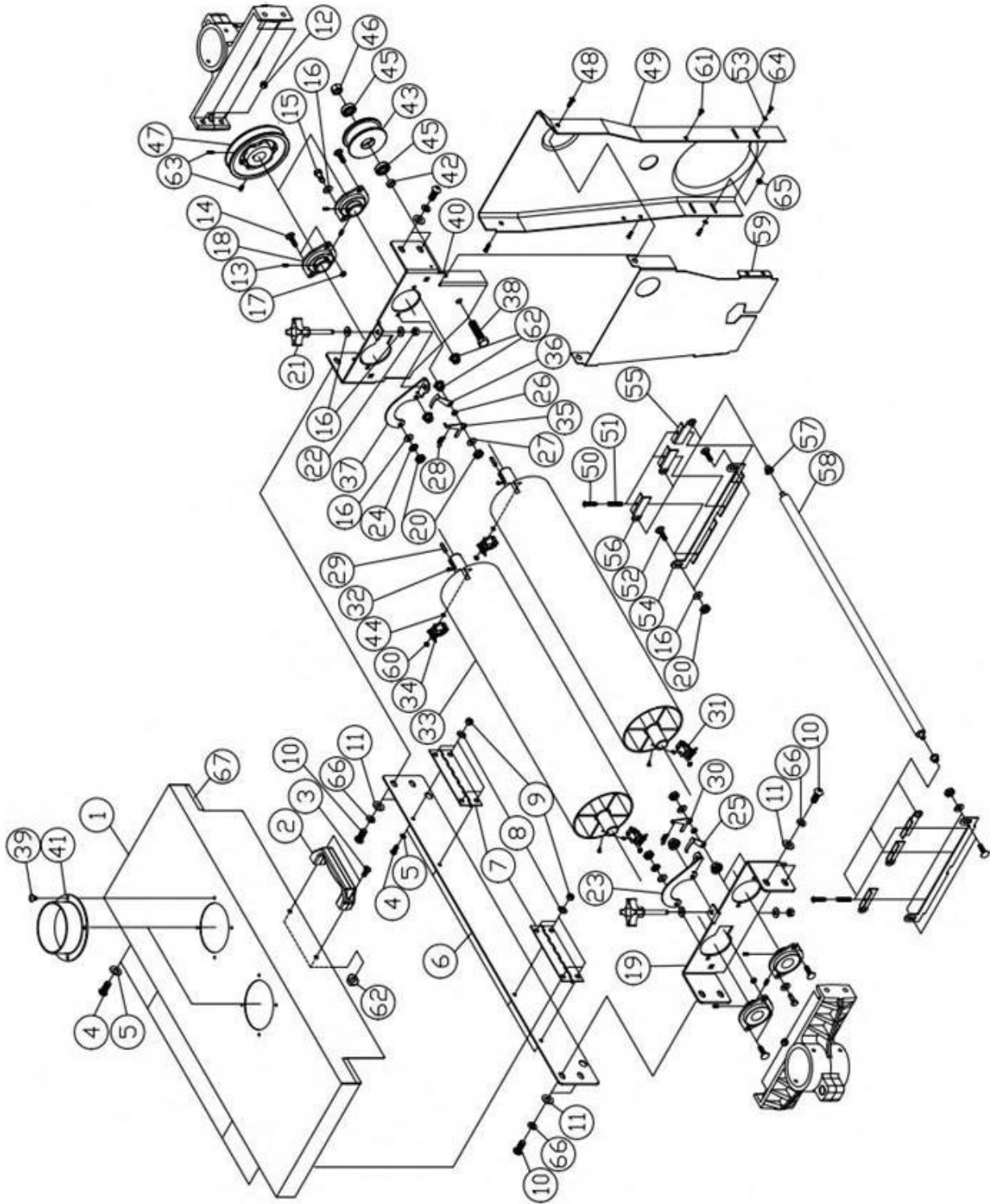

CONVEYOR & MOTOR PARTS LIST

Ref #	Description	Part #	Qty.
1	DRIVEN ROLLER	30-3103	1
2	SQUARE OILITE BUSHING, 1/2" I.D.	50-3109	4
3	TAKE UP-SLIDE BRACKET	635DS-328	2
4	LOCK-INT. TOOTH WASHER, 5/16"	635DS-336	4
5	HEX NUT, 5/16"-18	480BS-245	8
6	WRENCH	635DS-333	2
7	FLAT WASHER, 5/16"	11-0206	6
8	TAKE UP-BASE BRACKET	635DS-335	2
9	HEX CAP SCREW, 3/8"-16X1"	10-0205	16
10	HEX CAP SCREW, 5/16"-18X3"	635DS-337	2
11	NYLON INSERT LOCK NUT, 3/8"-16	12-8005	4
12	SPRING WASHER, 3/8"	20-1165	4
13	SIDE RAIL, RIGHT	40-4144	1
14	ROLLER SUPPORT BRACKET	635DS-338	1
15	DRIVEN ROLLER	30-3106	1
16	HEX CAP SCREW, 3/8"-16X3/4"	480BS-177	4
17	FLANGE LOCK NUT, 3/8"-16	12-0209	16
18	CONVEYOR BED	40-4101	1
19	SIDE RAIL, LEFT	40-4143	1
20	BOTTOM COVER	40-4116A	1
21	HEX CAP SCREW, 5/8"-11X1"	913002-321	1
22	SLOTTED HEX HEAD SCREW, #10-24X3/8"	10-3803	2
23	BOTTOM COVER	40-4146	1
24	SPEED ADJUSTMANT LABLE	480BS-208	1
25	SWITCH BRACKET	40-0124A	1
26	MAGNETIC SWITCH, 5HP, 1Ph	72-5400-1	1
27	FUSE HOLDER	72-6202-A	1
28	SCREW, M4X0.7X12	913002-328	2
29	STRAIN RELIEF, PG-13.5	PG-13.5	2
30	CORD SET, SINGLE PHASE	913002-354	1
31	PHILLIPS PAN HEAD SCREW, 5/32"-32X1/2"	10-3902	2
32	KNOB	72-1270-1	1

Ref #	Description	Part #	Qty.
33	STRAIN RELIEF, 6P-4	PLAREVO1216-190	1
34	FLAT WASHER, 3/8"X20X2t	11-0104	22
35	DC GEAR MOTOR, 180VDC	913003-303	1
36	MAIN CORD SET, SINGLE PHASE, (NOT INCLUDED)	913002-336A	
37	HEX CAP SCREW, 5/16"-18X1/2"	10-9101	4
38	CONTROL HOUSING	40-5013A	1
39	INTELLISAND CONTROLLER, 220 VOLT, SINGLE PHASE	72-2280	1
40	FLAT WASHER, M6	635DS-343	4
41	HEX NUT, M6X1.0	635DS-344	4
42	PLASTIC SUPPORT POST	635DS-345	2
43	SET SCREW, 5/16"-18X3/8"	10-8902	2
44	COUPLING (CONVEYOR)	30-3102	1
45	CARRIAGE BOLT, 5/16"-18X1"	10-1204	4
46	MOTOR, 5HP, 1Ph	70-0507	1
47	HEX NUT, #10-32UNF	480BS-216	2
48	SPRING WASHER, 5/16"	480BS-167	4
49	LOWER INNER BELT GUARD	40-1000A	1
50	LOCK WASHER, M6	635DS-342	4
51	DRIVE PULLEY	50-0450	1
52	KEY, 1/4"X1/4"X1"	20-0762	1
53	SET SCREW, 5/16"-18X3/8"	10-8903	2
54	STRAIN RELIEF, PG-13.5	PG-13.5-2	2
55	SOCKET HEAD CAP SCREW, M6X1.0X80	93267-2-409	4
56	V-BELT	50-2023	1
57	FLAT WASHER, 5/16" I.D. THIN	72-1270-3	1
58	JAM NUT, 5/16"-32UNEF	72-1270-4	1
59	CONVEYOR BELT	60-0324	1
60	FILLER BELT PLATE	40-1010	1
61	HEX CAP SCREW, 1/4"-20X3/8"	913002-361	2
62	FLAT WASHER, 1/4"	480BS-145	2
63	SCREW, #10-32UNFX1/2"	480BS-214	2
64	HEX NUT, 5/8"-11	913002-364	1

Ref #	Description	Part #	Qty.
65	LOCK-EXT. TOOTH WASHER, M5	635DS-350	3
66	STRAIN RELIEF, PG-21	PG-21	1
67	JUNCTION BOX	913003-354	1
68	RUBBER BUSHING, D25	PLAREVO1216-205	1
69	SCREW, M4X0.7X6	913003-356	4
70	SCREW, M6X1.0X8	913003-357	4
71	SCREW, M5X0.8X8	913003-361	1
72	CONNECTORS FOR JUNCTION BOXES (NOT SHOW)	913003-362	2(1Ph)

CONVEYOR & MOTOR

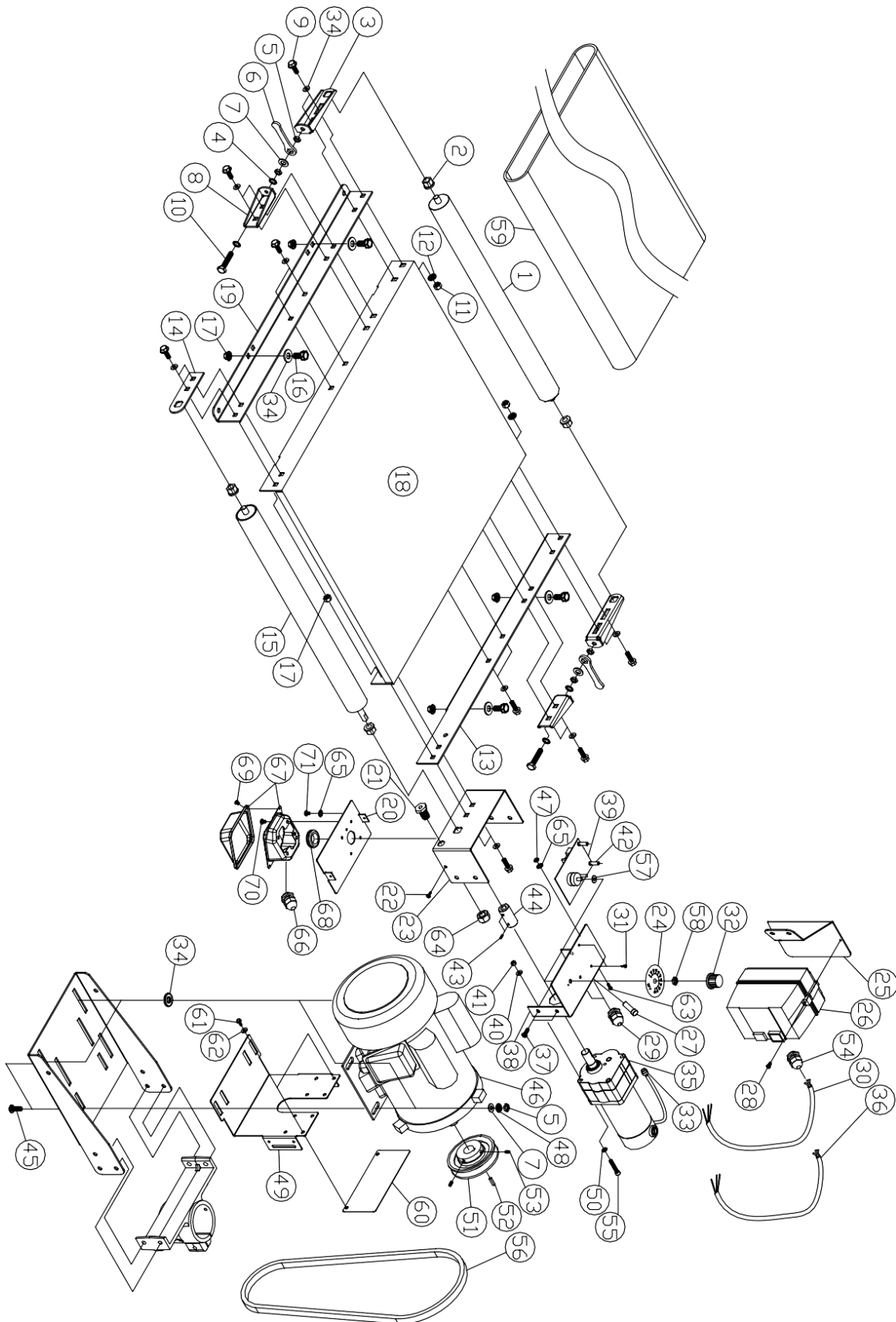

SPECIFICATIONS

SUPERMAX 25x2

Dimensions:	Height: 50"; Width: 48"; Depth 42"
Dust Hood:	Two 4" vacuum ports
Drums:	Two 5" x 25", Extruded aluminum, precision machined and balanced.
Bearings:	1" sealed, permanently lubricated, flanged ball bearings.
Abrasive Strips:	Tapered aluminum oxide, ceramic or zirconium cloth-backed abrasive wraps recommended. Fasteners accept any grit. No felt, hook & loop, or adhesive necessary. One wrap included.
Conveyor Bed:	Steel conveyor bed reinforced with steel cross sections.
Conveyor Motor:	Direct-drive DC motor. Infinitely variable from 0 to 15 feet per minute with Intellisand.
Conveyor Belt:	100-grit abrasive conveyor belt included.
Drive Motor:	5 HP; TEFC; 1 PH, 1,740 RPM; 208-230 volts; 60 HZ.
Minimum Stock Length:	3-1/2"
Height Adjustment:	3/32" per turn; Depth Gauge included.
Stock Thickness Capacity:	6"
Shipping Weight:	475 lbs.
Dust Collection:	1,000 CFM minimum & mandatory.

WARRANTY & REGISTRATION

THANK YOU!

Welcome to the Laguna Tools® group of discriminating woodworkers. We understand that you have a choice of where to purchase your machines and appreciate the confidence you have in the Laguna Tools® brand.

Through hands-on experience, Laguna Tools® is constantly working hard to make innovative, precision products. Products that inspire you to create works of art, are a joy to operate, and encourage your best work.

Laguna Tools®
Imagination, Innovation, and Invention at Work

WARRANTY & REGISTRATION

Every product sold is warranted to be free of manufacturers' defective workmanship, parts, and materials. For any questions about this product, the intended use or what it was designed for, customer service, or replacement parts, please contact our customer service department:

Laguna Tools® Customer Service
744 Refuge Way, Grand Prairie, Texas 75050, USA
1-800-234-1976
customerservice@lagunatools.com
www.lagunatools.com/why/customer-service/
8AM to 5PM PST, Monday through Friday

For warranty claims or to report damage upon receiving – please reach out to our warranty department:

Laguna Tools® Warranty Service
744 Refuge Way, Grand Prairie, Texas 75050, USA
1-800-332-4049
customerservice@lagunatools.com
www.lagunatools.com/policies/warranty/
8AM to 5PM PST, Monday through Friday

REGISTRATION

To prevent voiding this warranty, all products sold must be registered within thirty (30) days of receiving the product. Registering the product will enable the original purchaser to receive notifications about important product changes, receive customer service, and be able to file a warranty claim against defective workmanship, parts, or materials.

WHO IS COVERED

The applicable warranty covers only the initial purchaser of the product from the date of receiving the product. To file such claims, the original purchaser must present the original receipt as proof of purchase.

WHAT IS COVERED

The warranty covers any defects in the workmanship of all parts and materials that make up the machine unless otherwise specified. Any part, determined by Laguna Tools®, to have a defect will be repaired or replaced (and shipped), without charge. The defective item/part must be returned to Laguna Tools® with the complaint and proof of purchase in the original packaging that it was received in. In the event the item/part is determined to be not covered by this warranty, the customer will be responsible for the cost to replace the item/part and all related shipping charges.



WARRANTY LIMITATIONS

This limited warranty does not apply to natural disasters, acts of terrorism, normal wear and tear, product failure due to lack of maintenance or cleaning, damage caused by accident, neglect, or lack-of inadequate dust collection. The warranty may be voided against proof of misuse/abuse, damage caused where repair or alterations have been made or attempted by others, using the product for purposes other than those described as intended use (unless with consent by Laguna Tools®), modification to the product, or use with an accessory that was not designed for the product. It is the responsibility of the user to understand basic woodworking machinery settings and procedures and to properly maintain the equipment in accordance with the standards provided in this manual.

LENGTH OF WARRANTY

All new machines and optional accessories sold through an authorized dealer carry a two-year warranty effective the date of receiving the product. Machines sold for either commercial or industrial use have a one-year warranty. Wearable parts like throat plates, bandsaw guides, etc., have a ninety-day warranty.

Table A-1 Warranty Lengths

2 Year – New Machines Sold Through an Authorized Dealer
2 Year – Accessories Sold as Machine Options (excluding blades)
1 Year – Machines Sold for Commercial or Industrial Use
1 Year – Blades and Accessories outside of Machine Options
90 Days – Wearable Parts

Aside from being free of defects upon receiving, consumable parts, like cutters and abrasives, are not covered by this warranty unless otherwise stated by Laguna Tools®. These parts are designed to be used at the expense of the operator and are available for replacement or inventory purchase. The determination of a consumable part will be made on a case-by-case basis by Laguna Tools®.

SHIPPING DAMAGE

Laguna Tools® is not responsible for damage or loss caused by a freight company or other circumstances not in the direct control of Laguna Tools®. All shipping-related claims for loss or damage goods must be made to Laguna Tools within twenty-four hours of delivery.

HOW TO RECEIVE SUPPORT

To file a warranty-claim please contact the warranty department at 1-800-234-1976. To receive customer service or technical support please contact the customer service department at 1-800-332-4049. Parts, under warranty, are shipped at the expense of Laguna Tools® either by common carrier, FedEx ground services or similar method. Technical support to install replacement parts is primarily provided by phone, fax, email, or the Laguna Tools Customer Support Website.

LAGUNA

46 CONSIGNES DE SECURITE

1. MAINTENEZ TOUS LES PROTECTEURS en place et bon état de marche.
2. RETIREZ LES CLÉS ET OUTILS. Prenez pour habitude de
3. MAINTENIR VOTRE LIEU DE TRAVAIL PROPRE. Un endroit de travail mal entretenu est source d'accidents.
4. NE JAMAIS UTILISER DANS UN ENVIRONNEMENT DANGEREUX. N'utilisez jamais d'outils électriques dans les endroits humides; ne les exposez jamais à la pluie. Gardez le lieu de travail bien éclairé.
5. ÉLOIGNEZ LES ENFANTS et les visiteurs de l'endroit de travail lorsque la machine est en marche
6. EMPECHEZ LES ENFANTS D'UTILISER VOS OUTILS à l'aide de cadenas, d'interrupteurs électriques principaux et d'interrupteurs à clés.
7. -
ritaire si vous utilisez un outil pour effectuer ce pour quoi il a été conçu.
8. UTILISEZ LE BON OUTIL DE TRAVAIL. Ne forcez pas un pas été conçu.
9. UTILISEZ UNE RALLONGE ÉLECTRIQUE ADÉQUATE. Assurez-vous que la rallonge est en bon état et que son ampérage est adapté à la machine. Une rallonge sous-calibrée entraîne une chute de tension, causant perte de puissance et surchauffe. Le tableau A (voir page suivante) indique l'ampérage adéquat en fonction de la longueur du câble et de l'ampérage nominal indiqué sur la plaque signalétique de la machine. En cas de doute, utilisez un câble d'ampérage immédiatement supérieur.
10. PORTEZ DES VÊTEMENTS APPROPRIÉS. Ne pas porter de vêtements amples, de gants, de bracelets, de colliers et autres bijoux pouvant être happés par les parties mobiles de la machines. Portez des chaussures antidérapantes et rassemblez et couvrez les cheveux longs pour évitez que ceux-ci se prennent dans les parties mobiles de la machine.
11. PORTEZ TOUJOURS DES LUNETTES DE SÉCURITÉ. Portez toujours un masque de protection du visage ou respiratoire si la poussière est abondante. Les lunettes de vue ne sont pas des lunettes de sécurité et ne sont pas conçues pour résister aux impacts.
12. TRAVAIL SÉCURITAIRE. Utilisez des serres ou un étau pour maintenir la pièce en place lorsque c'est pratique. Plus sécuritaire, cela vous permet aussi de garder les mains libres pour manier un outil s'il y a lieu.
13. ÉVITEZ DE TRAVAILLER dans une position inconfortable ou instable. Gardez les deux pieds au sol en tout temps.
14. ENTRETENIR VOS OUTILS AVEC SOINS. Pour une meilleure performance et plus de sécurité, veillez à la propreté -
tion et le changement d'accessoires, suivez toujours les instructions fournies.
15. DÉBRANCHEZ TOUJOURS LA PONCEUSE avant de changer des accessoires comme les lames, forets, couteaux ou autres.
16. REDUIRE LE RISQUE DE DÉMARRAGE NON INTENTIONNEL. Assurez-vous que l'interrupteur est en position "OFF" avant de brancher la machine à une source électrique.
17. UTILISEZ SEULEMENT LES ACCESSOIRES RECOMMANDÉS. Consultez votre manuel les accessoires recommandés. L'utilisation de pièces et d'accessoires non recommandés augmente les risques de blessures.
18. NE MONTEZ JAMAIS SUR LA PONCEUSE. Vous risquez de subir de graves blessures si celle-ci bascule ou est mise en marche par mégarde.
19. INSPECTEZ BIEN LES PIÈCES ENDOMMAGÉES avant utilisation. Les protecteurs et pièces endommagés de-
des pièces en mouvement, les obstacles, bris, montures et points d'attache affectant l'opération sécuritaire de la machine. Un protecteur ou une pièce endommagée devrait être immédiatement remplacé.
20. DIRECTION DE L'ALIMENTATION. Passez la pièce de travail dans la ponceuse contre le sens de rotation du tambour.
21. NE LAISSEZ JAMAIS LA MACHINE EN FONCTION SANS SURVEILLANCE. METTEZ-LA HORS TENSION. Attendez qu'elle soit complètement arrêtée avant de quitter l'endroit de travail.

Certaines particules issues des opérations de ponçage, sciage, meulage, perçage ou d'autres procédés de fabrication contiennent des composés chimiques connus pour être à l'origine de cancers, de malformations congénitales et de troubles de la santé reproductive. Ces composés chimiques peuvent être:

- Le **plomb** contenu dans certaines peintures à base de plomb.
- La **silice cristalline** contenue dans les briques, le ciment et les matériaux de maçonnerie.
- L'**arsenic** et le **chrome** issus du traitement chimique des planches de bois.

Les risques encourus dépendent de la fréquence d'exposition à ces composés chimiques. Pour réduire l'exposition à ces com-

les masques respiratoires ou antipoussières spécialement conçus pour empêcher l'inhalation de micro-particules.

ACCESSORY & SUPPLY CHECKLIST

ITEM #	DESCRIPTION	QTY.
OPTIONS		
98-0130	CASTER SET: Heavy duty, roll & swivel lock. (Set of 4)	
ABRASIVES		
<p>Resin bond, non-adhesive abrasive cloth strips.</p> <ul style="list-style-type: none"> • Pre-Marked, 60 grit and finer covers 25" drum 12 times • Pre-Marked, 36 grit covers 25" drum 9 times • Pre-Cut, grit includes 3 wraps for 25" drums 		
Pre-Cut 25"	Pre-Marked	Size and Description
60-5024		24 GRIT: Surface rough sawn boards, stock & glue removal
60-5036	60-9036	36 GRIT: Surface rough sawn boards, stock & glue removal.
60-5060	60-9060	60 GRIT: Surfacing and dimensioning boards, trueing warped boards.
60-5080	60-9080	80 GRIT: Surfacing, light dimensioning, remove planer ripples.
60-5100	60-9100	100 GRIT: Light surfacing, remove planer ripples.
60-5120	60-9120	120 GRIT: Light surfacing, minimal stock removal.
60-5150	60-9150	150 GRIT: Finish sanding, minimal stock removal.
60-5180	60-9180	180 GRIT: Finish sanding, not for stock removal.
60-5220	60-9220	220 GRIT: Finish sanding, not for stock removal.
60-5000	n/a	Assortment: 1 strip each of 36, 80, 120 grit.
60-0505	ABRASIVE CLEANING STICK	
CONVEYOR BELTS		
100 grit abrasive with reinforced backing.		
60-0324	36" Power Feed Bed with 2" diameter Drive Roller.	

CAUTION: IMPORTANT SAFETY INFORMATION

FOR SAFE SANDING OPERATION, FOLLOW THESE GUIDELINES:

BECOME FAMILIAR WITH THE PROPER OPERATIONAL PROCEDURES FOR USING THIS MACHINE.

ALWAYS BE SAFETY CONSCIOUS WHEN OPERATING THE MACHINE.

ALWAYS WEAR EYE PROTECTION WHILE OPERATING THE SANDER.

ALWAYS FEED STOCK AGAINST THE ROTATION OF THE DRUM(S).

NEVER PLACE HANDS UNDER THE DRUM(S) OR DUST COVER.

NEVER OPERATE SANDER WITHOUT ITS DUST COVER OR DRUM AND BELT GUARDING IN PLACE.

KEEP HANDS AND CLOTHING AWAY FROM OPERATING DRUM(S), BELT AND PULLEYS.

ALWAYS MAINTAIN CONTROL OF STOCK TO AVOID KICKBACK; KNOW HOW TO PREVENT IT.

ALWAYS DISCONNECT ELECTRICAL POWER BEFORE PERFORMING ANY SERVICING OR ADJUSTMENT OF THE MACHINE.

DO NOT MODIFY THIS MACHINE: MODIFICATIONS ARE DONE AT THE OWNER'S RISK AND ALSO WILL VOID THE MANUFACTURER'S WARRANTY.

FOR CUSTOMER SERVICE AND QUESTIONS ABOUT THE OPERATION OR MAINTENANCE OF THIS MACHINE, PLEASE CALL YOUR AUTHORIZED LAGUNA TOOLS DEALERSHIP.