



SuperMax
Tools

OWNER'S MANUAL



19-38 DRUM SANDER

© 03/2017 SuperMax Tools Pat. 9,132,521



P. 888.454.3401
F. 651.454.3465

SuperMaxTools.com
sales@SuperMaxTools.com



CONGRATULATIONS

SuperMax Tools takes pride in our products and stands behind them with continuing service and support for our customers. Your SuperMax Tools sander was designed with several features that will bring a new dimension of productivity to your shop. Our goal at SuperMax Tools is to develop machines that provide you with maximum performance, maximum economy and maximum utility. Your 19-38 drum sander has features that will give you better results in less time in the years ahead. This sander is designed to be tailored to every project and features ultra-precise control for any sanding project.

This sander is covered with a warranty and your distributor can answer any questions you may have. Additionally, we will always be here to offer support, service information, and product supplies and services. Before using your sander for the first time learn how to use it. This manual covers unpacking step-by-step, sander set up and fine-tuning the controls. Safety information is also provided to make sure your process is hassle free. If you have any questions this manual will provide answers and you can also refer to our website or customer service for any updates or further details.

MODEL IDENTIFICATION

Your 19-38 drum sander is one of a family of machines from SuperMax Tools designed to help you achieve results comparable to industrial-size sanders at a fraction of the cost. For future reference, find the model, stock and serial numbers on the back of machine base and write them in below.

Model: _____

Date Purchased: _____

Stock Number: _____

Distributor: _____

Serial Number: _____

IMPORTANT: KEEP THIS MANUAL HANDY

Please read this manual first. It was designed to help you get the most from your 19-38 drum sander. Before unpacking or using the machine, familiarize yourself with its components, features, and basic adjustments by reviewing the following pages. You will find it an invaluable aid in setting up, operating and servicing your machine. If, after reviewing this manual, you still have a problem you can't solve, please call your SuperMax Tools distributor.

WARNING: SAFETY FIRST

When maintaining and operating this machine, always put safety first. For your own safety, read and understand this owner's manual before operating this machine. Always heed and follow all normal safety precautions, including the following:

- a. Always wear eye protection while operating sander.
- b. Always feed boards against the drum rotation.
- c. Tighten all locks before operating.
- d. Keep hands and clothing away from operating drum.
- e. Do not operate sander with dust cover opened.
- f. Do not operate sander without dust collector connected to the dust cover.
- g. Always maintain control of boards to avoid kickback (know how to prevent it).
- h. Always disconnect power before servicing or adjusting.



WARNING: FOR YOUR OWN SAFETY READ THIS INSTRUCTION MANUAL BEFORE OPERATING THE SANDER.

TABLE OF CONTENTS

SAFETY RULES	4
GROUNDING INSTRUCTIONS	5
SPECIFICATIONS.....	6
WARRANTY	6
ABOUT THE SUPERMAX TOOLS DRUM SANDER	7
UNPACKING YOUR DRUM SANDER.....	7
SETTING UP YOUR SUPERMAX TOOLS DRUM SANDER	11
Checking drum alignment.....	11
Connecting Dust Collectors	12
Power and Electrical Safety	12
ABRASIVE SELECTION GUIDE	12
Wrapping Abrasives	13
Proper Abrasive Wrap Position	14
Abrasive Wrap Tension Adjustment	14
Maximizing Abrasive Longevity	14
OPERATING YOUR DRUM SANDER	15
Drum Depth of Cut	15
Conveyor and Speed Rate.....	16
Stock Feeding Operation.....	16
Stock Feeding Maximum Performance.....	16
Tension Roller Pressure.....	17
Tension Roller Contact Adjustment.....	17
Conveyor Belt Tension.....	18
Conveyor Belt Tracking.....	18
MAINTENANCE	18
Monthly Maintenance.....	18
Replacing Conveyor Belts	18
Cleaning the Machine.....	19
SUPPLY CHECKLIST	19
TROUBLESHOOTING YOUR SUPERMAX TOOLS DRUM SANDER.....	20
WIRING DIAGRAM	22
PARTS LIST AND DIAGRAMS.....	23-27

SAFETY RULES

1. **KEEP GUARDS IN PLACE** and in working order.
2. **REMOVE ADJUSTING KEYS AND WRENCHES.** Form habit of checking to see that keys and adjusting wrenches are removed from tool before turning it on.
3. **KEEP WORK AREA CLEAN.** Cluttered areas and benches invite accidents.
4. **DON'T USE IN DANGEROUS ENVIRONMENT.** Don't use power tools in damp or wet locations, or expose them to rain. Keep work area well lighted.
5. **KEEP CHILDREN AWAY.** All visitors should be kept safe distance from work area.
6. **MAKE WORKSHOP CHILD PROOF** with padlocks, master switches, or by removing starter keys.
7. **DON'T FORCE TOOL.** It will do the job better and safer at the rate for which it was designed.
8. **USE RIGHT TOOL.** Don't force tool or attachment to do a job for which it was not designed.
9. **USE PROPER EXTENSION CORD.** Make sure your extension cord is in good condition. When using an extension cord, be sure to use one heavy enough to carry the current your product will draw. An undersized cord will cause a drop in line voltage resulting in loss of power and overheating. Table A (on the next page) shows the correct size to use depending on cord length and nameplate ampere rating. If in doubt, use the next heavier gage. The smaller the gage number, the heavier the cord.
10. **WEAR PROPER APPAREL.** Do not wear loose clothing, gloves, neckties, rings, bracelets, or other jewelry which may get caught in moving parts. Nonslip footwear is recommended. Wear protective hair covering to contain long hair.
11. **ALWAYS USE SAFETY GLASSES.** Also use face or dust mask if cutting operation is dusty. Everyday eyeglasses only have impact resistant lenses, they are NOT safety glasses.
12. **SECURE WORK.** Use clamps or a vise to hold work when practical. It's safer than using your hand and it frees both hands to operate tool.
13. **DON'T OVERREACH.** Keep proper footing and balance at all times.
14. **MAINTAIN TOOLS WITH CARE.** Keep tools sharp and clean for best and safest performance. Follow instructions for lubricating and changing accessories.
15. **DISCONNECT TOOLS** before servicing; when changing accessories, such as blades, bits, cutters, and the like.
16. **REDUCE THE RISK OF UNINTENTIONAL STABBING.** Make sure switch is in off position before plugging in.
17. **USE RECOMMENDED ACCESSORIES.** Consult the owner's manual for recommended accessories. The use of improper accessories may cause risk of injury to persons.
18. **NEVER STAND ON TOOL.** Serious injury could occur if the tool is tipped or if the cutting tool is unintentionally contacted.
19. **CHECK DAMAGED PARTS.** Before further use of the tool, a guard or other part that is damaged should be carefully checked to determine that it will operate properly and perform its intended function - check for alignment of moving parts, binding of moving parts, breakage of parts, mounting, and any other conditions that may affect its operation. A guard or other part that is damaged should be properly repaired or replaced.
20. **DIRECTION OF FEED.** Feed work into a blade or cutter against the direction of rotation of the blade or cutter only.
21. **NEVER LEAVE TOOL RUNNING UNATTENDED. TURN POWER OFF.** Don't leave tool until it comes to a complete stop.

Some dust created by power sanding, sawing, grinding, drilling and other construction activities contain chemicals known to cause cancer, birth defects or other reproductive harm. Some examples of these chemicals are:

- **Lead** from lead based paint.
- **Crystalline silica** from bricks, cement, and other masonry products.
- **Arsenic** and **chromium** from chemically treated lumber.

Your risk of exposure varies, depending on how often you do this type of work. To reduce your exposure to these chemicals, work in a well-ventilated area and work with approved safety equipment, such as face or dust masks that are specifically designed to filter out microscopic particles.

TABLE A - MINIMUM GAUGE FOR CORD

AMPERAGE RATING		VOLTS	TOTAL LENGTH OF CORD (IN FEET)			
-	-	120	25	50	100	150
-	-	240	50	100	200	300
MORE THAN	NOT MORE THAN	MINIMUM GAUGE FOR CORD				
0	6	-	18	16	16	14
6	10	-	18	16	14	12
10	12	-	16	16	14	12
12	16	-	14	12	Not recommended	

GROUNDING INSTRUCTIONS

1. All grounded, cord-connected tools:

In the event of a malfunction or breakdown, grounding provides a path of least resistance for electric current to reduce the risk of electric shock. This tool is equipped with an electric cord having an equipment-grounding conductor and a grounding plug. The plug must be plugged into a matching outlet that is properly installed and grounded in accordance with all local codes and ordinances.

- Do not modify the plug provided - if it will not fit the outlet, have the proper outlet installed by a qualified electrician.
- Improper connection of the equipment-grounding conductor can result in a risk of electric shock. The conductor with insulation having an outer surface that is green with or without yellow stripes is the equipment-grounding conductor. If repair or replacement of the electric cord or plug is necessary, DO NOT CONNECT the equipment-grounding conductor to a live terminal.
- Check with a qualified electrician or service personnel if the grounding instructions are not completely understood, or if in doubt as to whether the tool is properly grounded.
- Use only 3-wire extension cords that have 3-prong grounding plugs and 3 pole receptacles that accept the tool's plug.
- Repair or replace damaged or worn cord immediately.

2. Grounded, cord-connected tools intended for use on a supply circuit having a nominal rating less than 150 V:

- This tool is intended for use on a circuit that has an outlet that looks like the one illustrated in sketch **A** in Fig. 1. The tool has a grounding plug that looks like the plug illustrated in sketch **A** in Fig. 1. A temporary adapter, which looks like the adapter illustrated in sketch **B** and **C**, may be used to connect this plug to a 2 pole receptacle as shown in sketch **B** if a properly grounded outlet is not available. The temporary adapter should be used only until a properly grounded outlet can be installed by a qualified electrician. **This adapter is not permitted in Canada.** The green-colored rigid ear, lug, and the like, extending from the adapter must be connected to a permanent ground such as a properly grounded outlet box.

3. Grounded, cord-connected tools intended for use on a supply circuit having a nominal rating between 150 – 250 V, inclusive:

- This tool is intended for use on a circuit that has an outlet that looks like the one illustrated in sketch **D**. The tool has a grounding plug that looks like the plug illustrated in sketch **D**. Make sure the tool is connected to an outlet having the same configuration as the plug. No adapter is available or should

be used with this tool. If the tool must be reconnected for use on a different type of electric circuit, the reconnection should be made by qualified service personnel; and after reconnection, the tool should comply with all local codes and ordinances.

Fig. 1: Grounding Methods

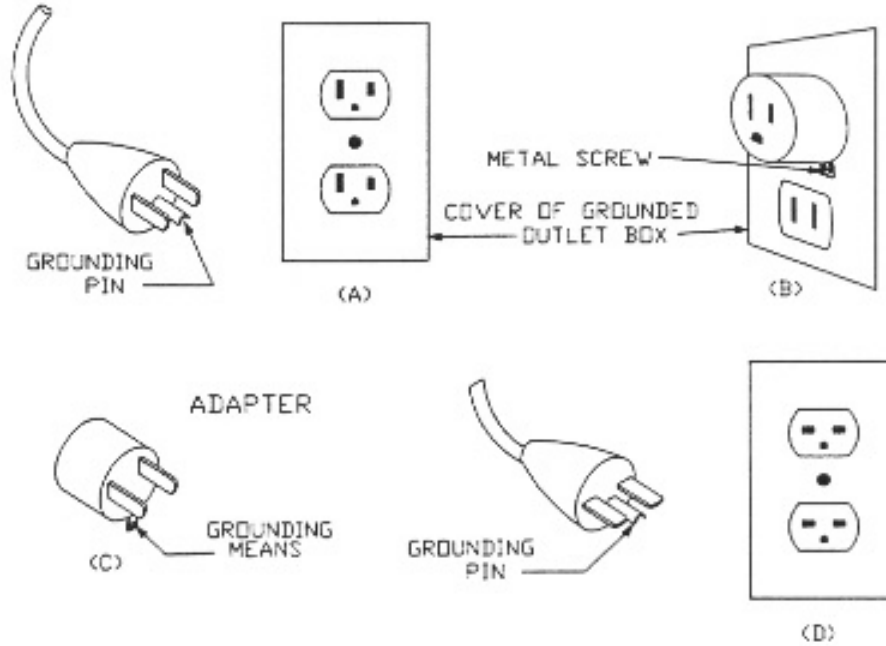

SPECIFICATIONS

Maximum Width	38" (2 passes)
Minimum Length	2-1/4"
Maximum Thickness	4"
Minimum Thickness	1/32"
Dimensions	36" x 42" x 24" (without stand)
Drum diameter	5" diameter - 1740 rpm.
Dust port diameter	4"
Height Adjustment	1/16" per revolution (depth scale included)
Conveyor Motor	Direct drive D.C. motor; Infinitely variable 0 - 10 ft/min
Drive Motor (TEFC)	1-3/4 HP - Continuous-duty
Power Requirements	110 V, 1 Ph, 20 A
Shipping Weight (3 boxes)	286 lbs (weight varies on how equipped)

2 YEAR WARRANTY

Limited warranty. We will provide all replacement parts which are found to be defective in materials or workmanship. Manufacturers' warranties on conveyor belts. Register the warranty for your new machine by filling out and mailing in the warranty registration card supplied in the package with each new machine.

NOTE: You can also register online using our fast and easy warranty form by visiting our website at www.SuperMaxTools.com

ABOUT THE SUPERMAX TOOLS DRUM SANDER

This manual is designed to help familiarize you with your SuperMax Tools drum sander, and to help you take advantage of its exclusive features. By understanding its major components, and how they work together, you will be able to get the most from your investment.

The SuperMax Tools drum sander is basically made up of:

1. Height adjustment handle of the drum.
2. Shroud.
3. Depth scale.
4. Knob to start feed conveyor and selects feed rate.
5. Starts and stops the motors.
6. Conveyor table.
7. Tension roller contact adjustment.
8. Drum carriage.



UNPACKING YOUR SUPERMAX TOOLS DRUM SANDER

Your 19-38 drum sander has been shipped mostly assembled from the factory. If any damage has occurred as a result of shipment, notify the transportation company as soon as possible and ask them to make an immediate inspection. Ask for a damage or loss report. Also notify your distributor of any loss or damage during shipment. See enclosed Warranty Statement.

NOTE: Before setting up make sure that the space is adequate for your new equipment. We also recommend that there is more than one person available for lifting and initial set up procedures.



TO AVOID PROBLEMS AND POTENTIAL DAMAGE TO THE MACHINE, PLEASE READ THROUGH THE UNPACKING INSTRUCTIONS BELOW BEFORE PROCEEDING TO SET UP THE MACHINE IN YOUR SHOP.



Assemble the SuperMax Tools 19-38 drum sander Open Stand #71938-OP or alternatively, if you have chosen to use your own bench prepare the existing bench for the sander attachment.

NOTE: See Open Stand #71938-OP manual included in the Open Stand shipping box for stand set-up and directions.



Open box 1 that contains the main sanding unit. Remove the cardboard liner. Open the plastic bag enclosing the sanding unit.

NOTE: There will be a small container of hardware included with your sander. This container will include everything you need to set up your sander (see above).



Cut each corner of BOX 1 to fold sides flat, providing access to sanding unit.

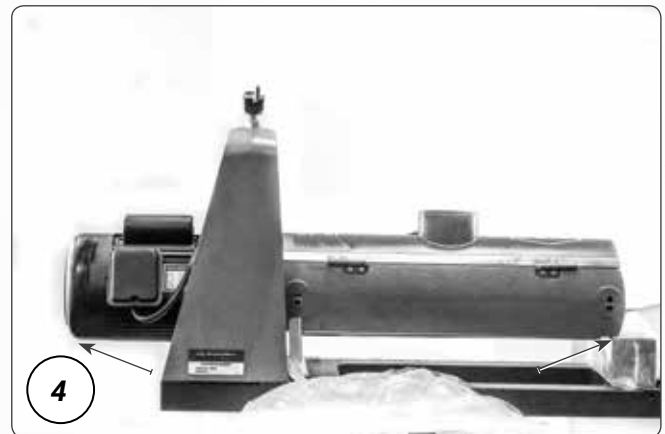

With one or two helpers, place the sanding unit on stand or bench (lift points marked).

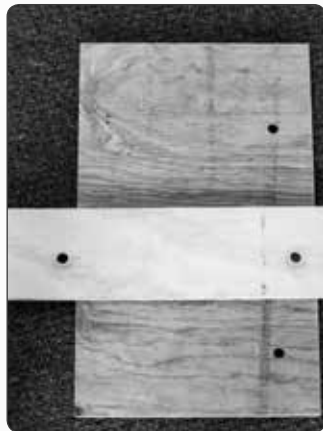

Remove the two wooden packing plates from bottom of the sanding unit using the enclosed wrench and keep wrench for future adjustments.



NOTE: These bolts that you just removed from the packing plates will work as your bolts for attaching the sander or as extra bolts for future replacement.



6
Install knob to height adjustment handle. First, finger tighten nut to knob. Thread stud from knob into hand wheel and tighten nut against hand wheel.



7
Turn the handle and raise sanding head to higher position to remove packing block from under carriage arm.



8
To prepare the unit for the installation of the conveyor belt, first remove the 2 bolts on the outboard (left) side of the conveyor belt.

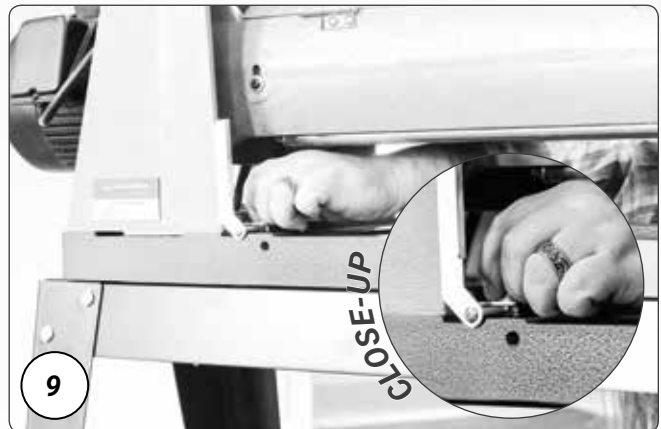

9
Next remove the 2 bolts on the inboard (right) side of the conveyor belt.



NOTE: Leave the silver plate, which is near the fast lever and under the motor, in place when removing bolts.

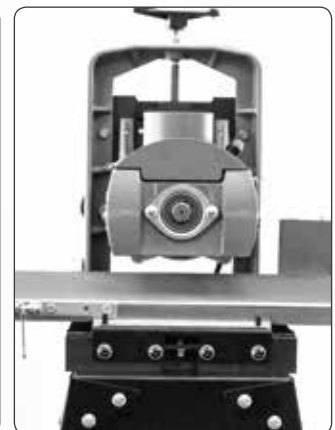

10
Open box 2 and remove conveyor from packaging and place on sanding unit. The conveyor motor should be nearest to the main motor and depth gauge.



NOTE: The fast lever should be in the upright position for installation of the sanding unit. The fast lever raises the inboard (right) side of conveyor up. Do not ever tighten the bolts all the way down. The fast lever should always be able to be moved back and forth between and up/down position. The bolts should be tightened, but not so tight that the fast lever doesn't move. The lever should be able to move from the down to up position easily.

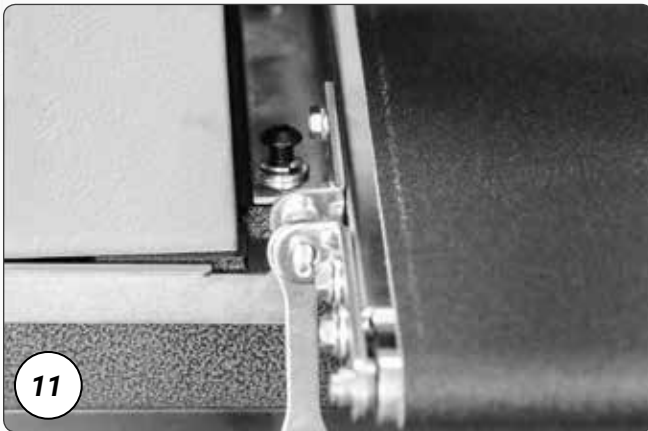

11
Install lock washer and flat washer onto two socket heads (or hex head bolts) and install into flange of conveyor bed on inboard (right) (motor side). Keep support plate in place on inboard (right) side and make sure the fast lever is positioned up.

12
Install two lock washers and two flat washers on the studs on outboard (left) side of the conveyor belt, then tighten all nuts and bolts with wrench.

NOTE: Do not completely tighten bolts with fast lever. See note above.



13
Plug the short power cord that is attached to the motor into the outlet on the control box. This cord will provide switched power for the motor when the machine is plugged into the power source.

14
Check your power supply to make sure that it is adequate (110 V, 20 A required) but do not plug the machine into the power supply until it is fully set-up.

SETTING UP YOUR DRUM SANDER

Your SuperMax Tools 19-38 sander should now be in place and ready for the final set-up. The sander was adjusted and aligned at the factory. However simple alignment checks will ensure that everything is in perfect order. Problems can be avoided if these essential checks and set-up procedures are performed prior to operation.

CHECKING DRUM ALIGNMENT

Checking the alignment before using the sanding drum is necessary to make sure that the drum is parallel.



1 Remove the abrasive on the drum. Removing the abrasive is necessary to make sure that the adjustment is as accurate as possible and the texture on the abrasive will make the adjustment imprecise.



2 Locate the height adjustment handle for raising and lowering the sanding head.

NOTE: The height adjustment handle controls the drum height. Turning the handle raises or lowers the sanding head. One revolution of the handle raises or lowers the head by 1/16 of an inch.

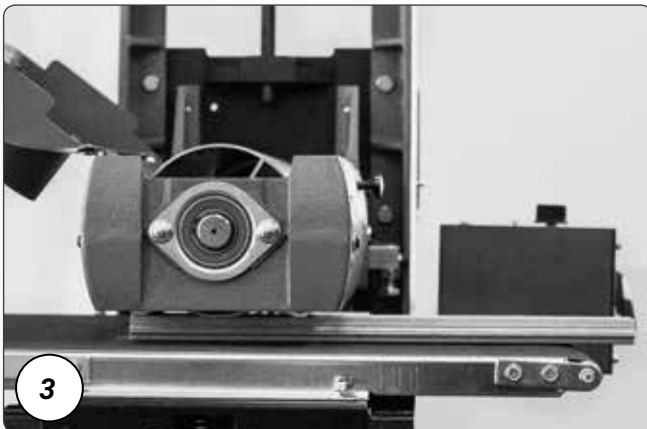

3 Use a flat, uniform piece of wood as a thickness gauge. Insert it between the conveyor belt and the drum on the inboard (right) side of the machine.

The tension rollers are set just below the drum enough so that items cannot pass easily underneath. Use the height adjustment handle as necessary to ensure that the piece of wood makes contact with the drum



4 After you place the piece of wood between the conveyor belt and the drum, rotate the height adjustment handle up one full turn. After the height has been adjusted the wood piece may be removed.

NOTE: You have to repeat these steps on the outboard (left) side of the machine using the same procedure. As you check look to make sure that the drum is parallel. A simple visual check that the drum is parallel is sufficient.

If the drum is not parallel, loosen the 4 socket head screws **A** (these screws are along the outboard (left) side of the conveyor belt) and raise or lower the conveyor with the adjustment nut **B** to achieve parallel alignment. Then tighten the four socket head screws.

To achieve parallel alignment on the inboard (right) side of the machine, repeat steps 3 and 4, then adjust the alignment if needed by loosening the 4 socket head screws located along the outboard (left) side of the conveyor and turning the height adjustment nut of the conveyor.

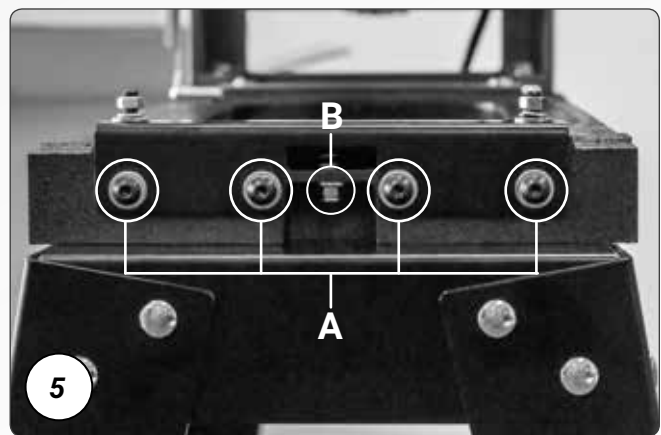

CONNECTING DUST COLLECTORS

Dust collection is necessary for the SuperMax Tools 19-38 drum sander. The sander comes equipped with a 4" diameter dust exhaust port at the top of the cover. Check to make sure that the minimum dust requirements are sufficient.

To attach to your collection system, install 4" hose from your collector. The minimum recommended dust collector capacities is 600 cfm. For best results, follow the recommendations of the manufacturer of your dust collection equipment.

When connecting dust collectors straight pipe is preferred because it is the least restrictive for airflow. If straight pipe is not possible Y's and elbows are preferred because they are less restrictive to airflow than T's.

NOTE: Some applications will require more dust collection than the recommended minimum.

POWER AND ELECTRICAL SAFETY

The SuperMax Tools 19-38 drum sander requires 110 V, single-phase 20 A service. After the dust collection system is in place and the drum alignment is checked your machine should be ready to be powered up and operated.



SAFETY NOTE: DO NOT REWIRE THE SUPERMAX TOOLS 19-38 DRUM SANDER TO 220 VOLT. ALWAYS DISCONNECT ELECTRICAL POWER BEFORE DOING ANY SERVICING OR ADJUSTING OF THE MACHINE.

ABRASIVE SELECTION GUIDE

GRIT COMMON APPLICATION

24 Grit	Abrasive planing, surfacing rough-sawn boards, maximum stock or glue removal
36 Grit	Abrasive planing, surfacing rough-sawn boards, maximum stock or glue removal
50 Grit	Surfacing and dimensioning boards, trueing warped boards
60 Grit	Surfacing and dimensioning boards, trueing warped boards
80 Grit	Light dimensioning, removal of planer ripples
100 Grit	Light surfacing, removal of planer ripples
120 Grit	Light surfacing, minimal stock removal
150 Grit	Finish sanding, minimal stock removal
180 Grit	Finish sanding only, not for stock removal
220 Grit	Finish sanding only, not for stock removal

INSTALLING AND WRAPPING ABRASIVES

Accurate attachment of the abrasive strip to the drum is critical to achieving the top performance from your SuperMax Tools 19-38 drum sander.

WRAPPING ABRASIVES

Abrasive strips do not have to be pre-measured. The end of the roll is first tapered and attached to the outboard (left) side of the drum. Then the strip is wrapped around the drum, and the second taper is made for attachment to the inboard (right) side of the drum. To attach a strip to the drum, follow the procedure below.

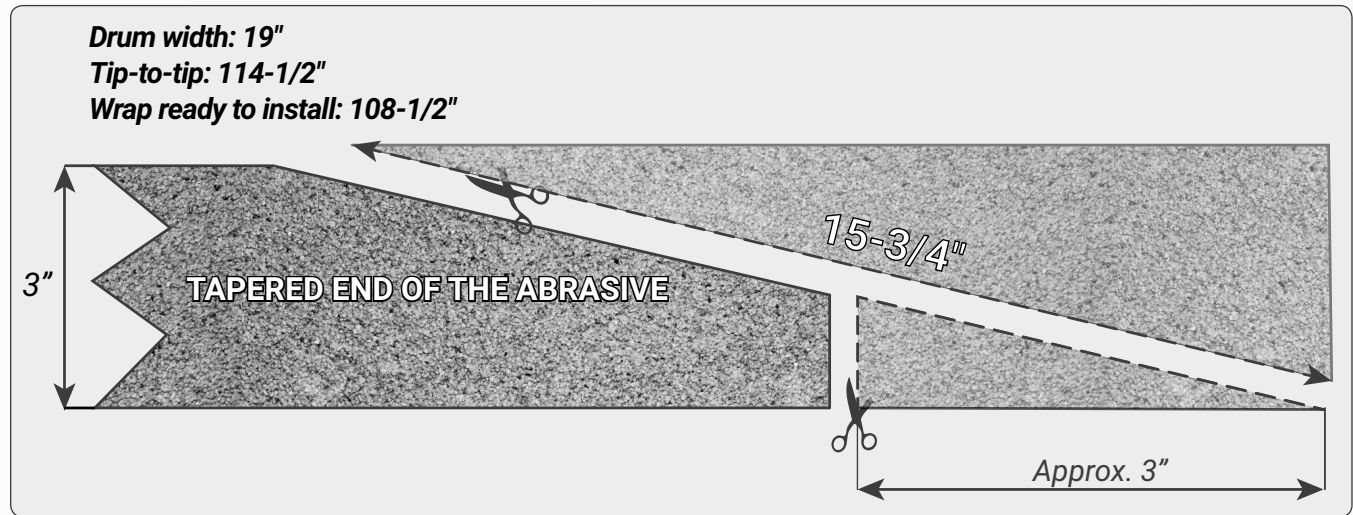

NOTE: Pre-cut wraps have been factory tapered to the specific width of your drum. If you are cutting your own abrasive, use the wrap that came on the drum as a template or the template below (abrasive side up).



1
Mark and cut a taper at one end of the roll as shown above. Because the tapered end should use most of the left (outboard) slot width, its end must be trimmed. Start on the left (outboard) side of the drum.

Pinch or squeeze the clip lever on the left (outboard) side of the drum. Insert the tapered end through the slot and into the fastener so that it uses most of the width of the slot. Release the clip lever to securely hold the wrap end in the fastener.



2
Wind the wrap around the drum, being careful not to overlap the windings. The tapered cut of the wrap end should follow the edge of the drum.

Continue to wrap the abrasive in a spiral fashion by rotating the drum with your left hand and guiding the wrap with your right hand. Successive windings of the wrap should be flush with previous windings without any overlap.



Pinch or squeeze the clip lever to open the clip, and pull the take-up lever to the top. Insert the tapered end through the slot in the inboard (right) end of the drum.



The take-up fastener is designed to automatically take up any slack caused by stretching of the abrasive wrap. The abrasive wrap may stretch enough in use to allow the take-up lever to reach its lowest position so it no longer is able to maintain tension on the wrap.

If this occurs, it will be necessary to reset the take-up lever by raising it, pushing the wrap end into the slot, and then releasing the clip lever.

NOTE: Take notice that for detail only the drum was removed to show the inboard (right) take-up fastener.

PROPER ABRASIVE WRAP POSITION

Position the abrasive wrap in the slot with sufficient room between the inside of the slot and the tapered end of the wrap to allow it to be pulled into the drum as needed (see opposite picture). If enough space is not left between the wrap and the inside of the slot the take-up fastener will not operate properly.

ABRASIVE WRAP TENSION ADJUSTMENT

The abrasive wrap may stretch enough in use to allow the take-up lever to reach its lowest position. If this occurs then tension is not longer maintained on the abrasive wrap. To fix this reset the take-up lever by raising it, pushing the abrasive wrap into the slot and then releasing the clip lever.



MAXIMIZING ABRASIVE LONGEVITY

A sandpaper cleaning stick may be used to remove deposits and help extend the life of the abrasive.

1. To use the cleaning stick, operate the sanding drum with the dust cover open and dust collection on.
2. Hold the cleaning stick against the rotating drum and move it along the drum surface.
3. Use a shop brush to remove any cleaning stick remnants from the drums before resuming sanding operations.



FOR YOUR OWN SAFETY ALWAYS WEAR EYE PROTECTION WHILE PERFORMING ABRASIVE CLEANING AND TAKE ALL PRECAUTIONS TO AVOID ANY CONTACT WITH HANDS OR CLOTHING ON THE UNCOVERED.

OPERATING THE 19-38 DRUM SANDER

Your sander will be able to perform an infinite variety of sanding projects all designed to your specifications. With some time and experimentation the proper setting and technique for each job will become apparent.

DRUM DEPTH OF CUT

Determining the depth of cut is the most important operating procedure decision. It may take some experimentation to determine the proper depth of cut. The crucial variables to keep in mind are abrasive grit, type of wood, project type, and conveyor feed rate. We recommend practicing on a scrap of wood prior to sanding a project.

• Depth Scale Operation

The depth scale (see opposite picture) measures the distance between the conveyor table and the bottom of the sanding drum. The sanding head must be parallel to the conveyor bed surface.

1. To calibrate the depth scale, loosen the two screws holding the scale. Lower the drum (with abrasive installed) until the drum touches the conveyor belt.
2. Slide the scale to align with the pointer at the "0" mark. Tighten the two screws holding the scale.

An optional DRO (digital read out) for depth is available (see opposite picture). This offers the most precise reading of sanded thickness and allows for accurate repeatability of a thickness. Great when making parts that must be an exact thickness or when matching a thickness.

1. To operate, turn ON and select standard inch "in" or metric millimeter "mm".
2. Lower drum, with abrasive installed, until it touches the conveyor belt. Press "zero" button to calibrate.

• Using Thickness Gauge

Another method to set depth of cut is to use the thickness gauge attached to the inboard (right) side of the sander (see opposite picture). The gauge must be adjusted to the same height as the abrasive in use.

1. Place a flat piece of scrap stock under the drum with the abrasive in place. Lower the drum until the abrasive lightly touches the scrap piece of stock.
2. Without changing the height, place the scrap stock under the thickness gauge. Adjust the bottom of the gauge by loosening the large nut and rotating the gauge up or down until it lightly touches the scrap piece of stock.
3. Tighten the large nut. Now the stock can be placed under the thickness gauge and the drum lowered until the gauge lightly touches the stock to be sanded. By using this method the stock does not need to be carried under the drum to set depth of cut.

A good rule of thumb when sanding is to place the stock under the drum and lower the sanding head until the stock is in contact with the drum but the drum can still be rotated by hand. Normally as the depth of cut is adjusted the handle will be rotated no more than a third of a turn at any time. INTELLISAND will help with this process.

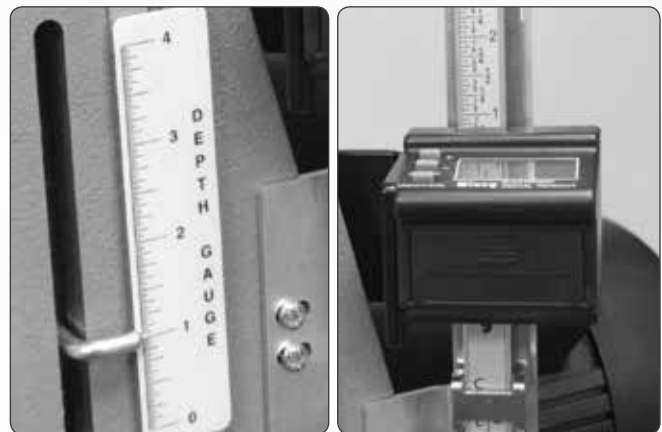

CONVEYOR AND SPEED RATE

After the depth of cut has been determined, selecting the proper feed rate is essential. For finish sanding the best finish is usually achieved with a slow to moderate feed rate. This allows for the most revolutions of the drum per inch of sanding. Faster feed rates can be used as long as the machine is not over-stressed.

When finish sanding with grits finer than 80, the best finish can usually be obtained if INTELLISAND does not engage. If INTELLISAND does slow the conveyor when finish sanding, it is best to make another sanding pass without changing the thickness setting and sand again.

NOTE: INTELLISAND will automatically adjust the conveyor feed rate if an excess load is detected. This prevents excessive gouging, reduces the risk of burning and protects the machine from overload or stalling. The red light by the adjustment knob will come on when INTELLISAND is operating. When the load is decreased, INTELLISAND will automatically increase the feed rate to the pre-selected speed.

STOCK FEEDING OPERATION

To feed stock through the sander rest the stock and hold the stock to be sanded on the conveyor table. Allow the conveyor to carry the stock into the drum. Once the stock is halfway through, reposition yourself to the outfeed side of the machine to receive and control the stock as it exits the unit.

STOCK FEEDING MAXIMUM PERFORMANCE

The built-in versatility of the SuperMax Tools 19-38 drum sander allows it to be used for a wide range of tasks. Learning to use the multiple controls to make adjustments will allow you to fine tune the machine for maximum results no matter what the job. The best results come from experimenting with different machine adjustments to best fit the job at hand.

- **Sanding stock wider than the drum**

When dealing with stock that is wider than the drum the fast lever will be very useful (see opposite picture). Wide stock may require extra space between the drum and conveyor along the outboard (left) edge. The extra space will help prevent an overlap line or ridge from developing along the sanded part where it extends beyond the sanding drum.

Adjusting the fast lever approximately half-way between the full upright and full downright position allows for easy alteration of the drum position in relationship to the conveyor without changing the initial drum alignment. It is a good idea to test a scrap piece of stock prior to sanding. If a line or ridge is still visible after adjusting the fast lever additional adjustments can be made to the drum alignment. After sanding stock wider than the drum the fast lever should be adjusted back to the original position. The fast lever should be put into the up position.



Adjusting the fast lever approximately half-way between the full upright and full downright position allows for easy alteration of the drum position in relationship to the conveyor without changing the initial drum alignment. It is a good idea to test a scrap piece of stock prior to sanding. If a line or ridge is still visible after adjusting the fast lever additional adjustments can be made to the drum alignment. After sanding stock wider than the drum the fast lever should be adjusted back to the original position. The fast lever should be put into the up position.

NOTE: The fast lever raises the inboard (right) side of the table .003. Never tighten the bolts all the way down. The fast lever should always be able to be moved back and forth between an up/down position. The bolts should be tightened, but not so tight that the fast lever doesn't move.

- **Sanding multiple pieces simultaneously**

When sanding multiple pieces at once, make sure to stagger or step the pieces across the width of the conveyor belt. This position provides better contact with the tension rollers. It is best to only process multiple pieces that are all of a similar thickness. If there is a thickness difference the thinner pieces may not come in contact with the tension rollers and may slip on the conveyor belt.

- **Sanding Imperfect or Tall Stock**

To avoid bodily injury take special care when sanding stock that is twisted, bowed or otherwise varied in thickness from end to end. If possible support such stock as it is being sanded to keep it from slipping or tipping. Use extra roller stand, assistance from another person, or hand pressure on the stock to minimize potentially hazardous situations. When sanding high or tall stock special attention is necessary to prevent tipping or slippage. Extra care may be needed as the stock exits the machine.

- **Stock Feeding Position and Angle**

Positioning the stock at an angle will allow the most effective stock removal and least loading on the abrasives. Feeding stock straight through yields the widest sanding capacity and least noticeable scratch pattern. Some pieces because of their dimensions will need to be fed into the sander at a 90-degree angle, which will be perpendicular to the drum. However, even a slight offset angle of the stock can provide for more effective sanding. Final pass sanding should be done following the grain pattern.

TENSION ROLLER PRESSURE

The tension roller pressure is factory set and should be adequate. However, the pressure of each roller can be adjusted as needed.

To increase the tension turn the tension adjusting screw clockwise 1/4 revolution at a time. To decrease tension turn the adjusting screw counter-clockwise 1/4 revolution at a time (see opposite picture).

NOTE: Too little pressure can result in slippage of stock on conveyor belt or kick-back. Too much tension can cause snipe when drum sanding.



TENSION ROLLER CONTACT ADJUSTMENT

The tension rollers are factory set for the most versatile use.

1. If necessary, to adjust tension roller contact, loosen the four socket head screws holding the tension roller brackets (two per side; front and back – shown in opposite picture).
2. Have abrasive wrapped on drum.
3. With machine unplugged, lower sanding drum until it rests on conveyor belt.
4. Raise drum 2 to 3 revolutions.
5. Tighten the four socket head screws (two per side; front and back).
6. Raise drum up, off of the conveyor belt.
7. Set drum for proper sanding height and process stock.



CONVEYOR BELT TENSION

Insufficient belt tension will cause slippage of conveyor belt on the drive roller during sanding operation. The conveyor belt is too loose if it can be stopped by hand pressure applied directly to the top of the conveyor belt. Excessive belt tension can result in bent rollers, premature wearing of the bronze bushings or conveyor belt

To adjust the tension of the conveyor belt, first adjust the take-up screw nut on both sides of the conveyor to obtain approximately equal tension on both sides of the belt when taut (see opposite picture).

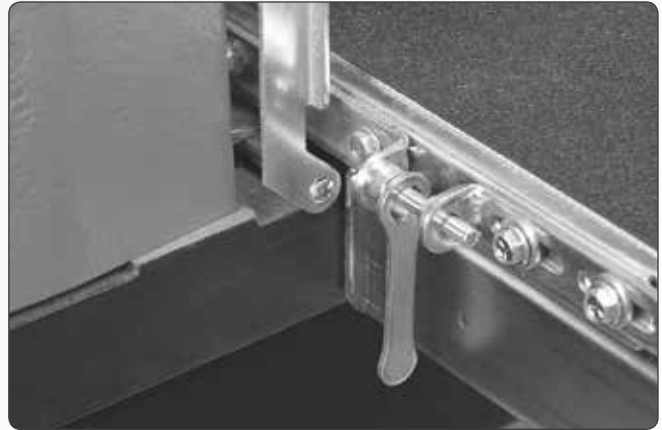

CONVEYOR BELT TRACKING

Belt tracking adjustments are made while the conveyor belt is running. After the proper belt tension is obtained turn the conveyor unit on and set it at the fastest speed setting. Watch for a tendency of the conveyor belt to drift to one side of the conveyor. To adjust the belt tracking, tighten the take-up screw nut on the side the belt is drifting toward, and loosen the take-up screw nut on the opposite side. Adjusting the take-up screw nuts on either side of the conveyor allows belt-tracking adjustments to be made without affecting belt tension. Note: Adjust the take-up screw nuts only 1/4 turn at a time. Then allow time for the belt to react to the adjustments before proceeding further. Avoid over-adjustments.

MAINTENANCE

MONTHLY MAINTENANCE CHECKLIST

- **Lubricate conveyor bushings and check for wear.**
- **Lubricate with a dry lubricant spray all of the moving parts, such as threaded rods and washers.**
- **Clean dust from conveyor belt.**
- **Check all set screws for tightness.**
- **Clean drum and abrasives if necessary.**

REPLACING CONVEYOR BELTS

To replace the conveyor belt, the conveyor assembly must be removed from the machine.

1. Raise the drum carriage to its highest position using the height adjustment handle.
2. Turn off power source to machine. Unplug main drive motor from receptacle (in gear motor assembly).
3. Loosen the conveyor take-up screws to relieve belt tension and slide the drive roller fully inward.
4. Remove the two Allen head bolts on the inboard (right) side that attach the conveyor assembly to the base.
5. Remove the two nuts and washers from outboard (left) side (see opposite picture).
6. Lift the conveyor and remove it from the sander. Set conveyor on motor side. Avoid tearing the belt on any edges underneath the conveyor bed during removal. Reverse the procedure for re-installation. Re-install the conveyor bed to sander.



TROUBLESHOOTING YOUR SUPERMAX TOOLS DRUM SANDER

Any operating problems with the drum sander will likely occur most often during the period that you are becoming familiar with its components and their adjustments. If you are experiencing a problem affecting the machine's performance, check the following listings for potential causes and solutions; it may also pay to review the previous sections in this manual on setting up and operating your machine.

TROUBLESHOOTING GUIDE: MOTORS

PROBLEM	POSSIBLE CAUSE	SOLUTION
MOTOR DOES NOT START	Main power cord unplugged from receptacle	Plug in primary power cord
	Drum motor cord unplugged from receptacle near power-feed motor.	Plug in drum motor cord at receptacle on machine if so equipped (Fig 5)
	Circuit fuse blown or circuit breaker tripped	Replace fuse or retrip breaker (after determining cause)
BRUSH MOTOR OVERLOADS	Inadequate circuit	Check electrical requirements
	Machine overloaded	Use slower feed rate; reduce depth of cut
CONVEYOR MOTOR OSCILLATES	Motor not properly aligned	Loosen housing bolts, run motor, retighten bolts.
	Shaft collar or bushing worn	Replace shaft collar or bushing
	Drive roller bent	Replace drive roller
DRUM MOTOR OR CONVEYOR GEAR MOTOR STALLS	Excessive depth of cut	Reduce depth of cut; reduce feed rate

TROUBLESHOOTING GUIDE: CONVEYOR

PROBLEM	POSSIBLE CAUSE	SOLUTION
CONVEYOR DRIVE ROLLERS RUN INTERMITTENTLY	Shaft coupling loose	Align shaft flats of gear motor and drive roller; tighten shaft coupling set screws
CONVEYOR BELT SLIPS ON DRIVE ROLLER	Improper conveyor belt tension	Adjust belt tension
	Excessive depth of cut	Reduce depth of cut reduce feed rate

PROBLEM	POSSIBLE CAUSE	SOLUTION
STOCK SLIPS ON CONVEYOR BELT CAUSING GOUGING	Excessive depth of cut	Reduce depth of cut
	Tension rollers too high	Lower tension rollers
	Excessive feed rate	Reduce feed rate
	Dirty or worn conveyor belt	Clean or replace conveyor belt
CONVEYOR MOTOR STALLS	Belt out of adjustment	Readjust belt
	Roller bushings elongated due to excessive wear	Replace bushings

TROUBLESHOOTING GUIDE: MACHINE

PROBLEM	POSSIBLE CAUSE	SOLUTION
DRUM HEIGHT ADJUSTMENT WORKS IMPROPERLY	Improper adjustment of height control	Readjust height control
KNOCKING SOUND WHILE RUNNING	Bearing worn	Replace bearing Contact distributor
SNIPING OF WOOD (GOUGING NEAR END OF BOARD)	Inadequate support of stock	Use roller stands to support stock
	Conveyor drive or driven rollers higher than conveyor bed	Readjust rollers
	Excessive tension roller pressure	Adjust rollers
BURNING OF WOOD OR MELTING OF FINISH	Feed rate too slow	Increase feed rate
	Excessive depth of cut	Reduce depth of cut
CONVEYOR MOTOR STALLS	Conveyor belt is too loose	Adjust belt tension
	Excessive depth of cut	Reduce depth of cut
	Wood slipping on conveyor due to lack of contact	Use alternate feeding procedure

19-38 - WIRING DIAGRAM

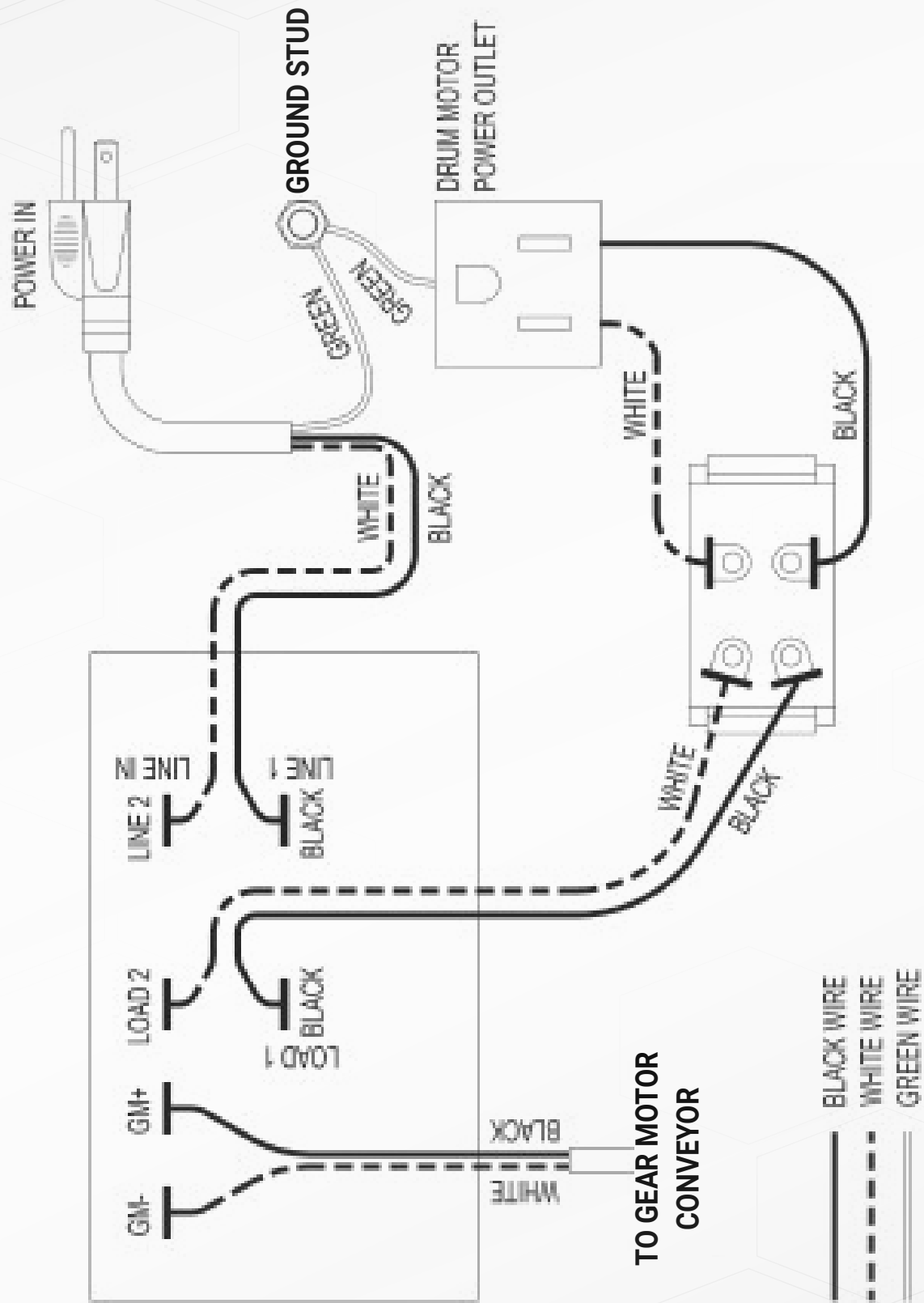

19-38 - PARTS LIST - HEAD ASSEMBLY

#	PART NO.	DESCRIPTION	SIZE	QTY
1	480DS-101	MOTOR		1
	480DS-101	MOTOR FAN COVER		1
2	480BS-134	STRAIN RELIEF, MOTOR	7N-2	1
3	480DS-103	MAIN CORD, MOTOR TO CONTROL BOX		1
4	480BS-104	KEY	3/16" SQ X 3/4"	2
5	480BS-105	NYLON INSERT LOCK NUT	5/16" - 24	4
6	480BS-106	FLAT WASHER	5/16"	9
7	480BS-107	OILITE WASHER		8
8	480BS-108	MOTOR PLATE		1
9	480BS-109	SET SCREW	#8-32 X 1/4"	1
10	480BS-110	HEX CAP SCREW	5/16" - 18X1-1/4"	6
11	480BS-111	LOCK WASHER	3/8"	4
12	480BS-112	SOCKET HEAD CAP SCREW	3/8" - 16X1-1/2"	4
13	480BS-113	SET SCREW	1/4"-20X1/4"	5
14	480BS-114	COUPLING		2
15	480BS-115	COUPLING SPIDER		1
16	480BS-116	DEPTH SCALE PLATE		1
17	480BS-117	SCREW, PHIL PAN HEAD	M4X0.7X6	14
18	480BS-118	LABEL, DEPTH SCALE (INCH)		1
19	480BS-119	DEPTH SCALE POINTER		1
20	480BS-120	KNOB		1
21	480BS-121	HEIGHT ADJUSTMENT HANDLE		1
22	480BS-122	NYLON INSERT LOCK NUT	5/8"-11	1
23	480BS-123	HEIGHT ADJUSTMENT SCREW		1
24	480BS-124	E-RING	E12	1
25	480BS-125	THRUST BEARING	51103	1
26	480BS-126	SHROUD		1
27	480BS-127	STUD		4
28	480BS-128	HEX CAP SCREW	3/8"-16X1-1/4"	4
29	480BS-129	FLAT WASHER	3/8"	8
30	480BS-130	HINGE		2
31	480DS-131	DUST COVER		1
32	480BS-132	HANDLE		1
33	480BS-133	PAN HEAD MACHINE SCREW	#8X1/2"	2
34	480DS-134	LOCK WASHER	M3	2
35	480BS-135	DUST COVER LATCH		1
36	480DS-136	PHILLIPS FLAT HEAD SCREW	M3X0.5X10	2
37	480DS-137	SANDING DRUM		1
38	480DS-138	NYLON INSERT LOCK NUT	M3X0.5	2
39	480DS-139	INBOARD (RIGHT) ABRASIVE FASTENER		1
40	480DS-140	OUTBOARD (LEFT) ABRASIVE FASTENER		1
41	480DS-141	CARRIAGE BOLT	5/16"-18X1	4
42	480DS-142	BEARING	6205ZZ	2
43	480DS-143	C-RING	S25	2
44	480DS-144	DRUM CARRIAGE		1
45	480BS-145	FLAT WASHER	1/4"	5

19-38 - PARTS LIST - HEAD ASSEMBLY

#	PART NO.	DESCRIPTION	SIZE	QTY
46	480BS-146	ROUND SOCKET HEAD CAP SCREW	1/4"-20X1"	4
47	480BS-147	FLAT WASHER	5/16"	4
48	480DS-148	BEARING SEAT		2
49	480BS-149	HEX CAP SCREW WITH WASHER	#10-24X3/8"	2
50	480BS-150	DUST COVER CATCH		1
51	480BS-151	STUD		1
52	480BS-152	SPRING		1
53	480BS-153	TENSION ROLLER		2
54	480BS-154	BUSHING, OILITE		4
55	480BS-155	TENSION ROLLER BRACKET, INNER LEFT		1
56	480BS-156	SCREW	#8-32X1"	4
57	480BS-157	SPRING, TENSION ROLLER		4
58	480BS-158	TENSION ROLLER BRACKET, INNER RIGHT		1
59	480BS-159	PAD, BRACKET-TENSION ROLLER		2
60	480BS-160	BRACKET		2
61	480BS-161	PLATE		1
62	480BS-162	BASE		1
63	480BS-163	ADJUSTING LEVER (FAST)		1
64	480BS-164	ADJUSTING ROD		1
65	480BS-165	HEIGHT ADJUSTING PLATE		1
66	480BS-166	ROUND SOCKET HEAD CAP SCREW	5/16"-18X1/2"	4
67	480BS-167	LOCK WASHER	5/16"	5
68	480BS-168	SPRING		3
69	480BS-169	NYLON INSERT LOCK NUT	1/4"-20	1
70	480DS-170	SOCKET HEAD CAP SCREW	M8X1.25X40	1
71	480DS-171	HEX NUT WITH WASHER	5/16"-18	4
72	480DS-172	BLOCK, MEASURING DEVICE		1
73	480DS-173	HEX NUT	M12X1.75	1
74	480DS-174	STOP BOLT		1
75	480DS-175	SCREW	M3X0.5X6	2
76	480DS-176	LOWER FIXED PLATE, DRO		1
77	480BS-177	HEX CAP SCREW	3/8"-16X3/4"	4
78	480DS-178	HEX NUT	M4X0.7	1
79	480BS-179	TENSION ROLLER BRACKET, RIGHT		1
80	480BS-180	TENSION ROLLER BRACKET, LEFT		1
81	480BS-181	E-RING	E5	1
82	480DS-182	UPPER FIXED PLATE, DRO		1
83	480DS-183	BATTERY COVER		1
84	480DS-184	LABEL		1
85	480BS-185	HEIGHT DIRECTION LABEL		1
86	480BS-186	MAINTENANCE LABEL		1
87	480BS-187	WARNING LABEL		1
88	480DS-188	BATTERY		1
89	480DS-189	DIGITAL READOUT ASSEMBLY (OPTIONAL)		1
90	635DS-280	FASTENER TOOL (OPTIONAL)		1

19-38 - PARTS LIST - CONVEYOR AND MOTOR

#	PART NO.	DESCRIPTION	SIZE	QTY
1	480BS-201	GEAR MOTOR	90 VDC	1
2	480DS-202	STRAIN RELIEF, POWER CORD	6P3-4	1
3	480DS-203	POWER CORD		1
4	480BS-204	FLAT WASHER	5/16"	4
5	480BS-205	SOCKET HEAD CAP SCREW	#10-32X1/2"	4
6	480BS-206	TRACKER KIT (OPTIONAL)		2
7	480BS-207	KNOB		1
8	480BS-208	SPEED ADJUSTMENT LABEL		1
9	480BS-209	WIRING GUARD		1
10	480DS-210	CONTROLLER		1
11	480DS-211	CONTROL HOUSING BRACKET		1
12	480BS-212	PAN HEAD SELF-TAPPING SCREW	5/32"X1/2"	2
13	480DS-213	RECEPTACLE, MAIN CORD		1
14	480BS-214	SCREW	#10-32X1/2"	1
15	480BS-215	WASHER, LOCK-INT. TOOTH	#10	2
16	480BS-216	HEX NUT	#10-32	2
17	480BS-217	SCREW, HEX HEAD SLOTTED	#10-32X3/8"	5
18	480BS-218	SCREW, PHIL PAN HEAD	#6-32X1/2"	2
19	480BS-219	SWITCH ON/OFF		1
20	480BS-220	COUPLER, SHAFT		1
21	480BS-113	SET SCREW	1/4"-20X1/4"	2
22	480BS-222	BRACKET, BASE-CONTROLLER		1
23	480BS-223	COVER, BASE-CONTROL HOUSING		1
24	480BS-224	HEX CAP SCREW	1/4"-20X3/4"	12
25	480BS-225	WASHER, WAVE	1/4"	4
26	480BS-145	FLAT WASHER	1/4"	4
27	480BS-227	BRACKET, TAKE UP-SLIDE		2
28	480BS-154	BUSHING, OILITE		4
29	480BS-229	ROLLER, DRIVEN		1
30	480BS-230	WRENCH		2
31	480BS-231	HEX NUT	1/4"-20	2
32	480BS-232	WASHER, LOCK-INT. TOOTH	1/4"	2
33	480BS-233	SCREW, ROUND HEAD-SLOTTED	1/4"-20X1-3/4"	2
34	480BS-234	BRACKET, TAKE UP-BASE		2
35	480BS-167	LOCK WASHER	5/16"	4
36	480BS-236	ROLLER, DRIVE		1
37	480BS-237	BRACKET, SUPPORT-DRIVE ROLLER		1
38	480BS-238	BED, CONVEYOR		1
39	480BS-239	SOCKET HEAD CAP SCREW	5/16"-18X3/4"	2
40	480DS-240	BELT CONVEYOR, ABRASIVE (NOT SHOWN)		1
41	480BS-204	FLAT WASHER	5/16"	1
42	480BS-242	HEX NUT	5/16"-24	1
43	480BS-243	SLOTTED SET SCREW	#8-36X5/16"	1
44	480BS-244	STRAIN RELIEF, GEAR MOTOR	6N-4	1
45	480BS-245	HEX NUT	5/16"-18	2

19-38 - CONVEYOR AND MOTOR

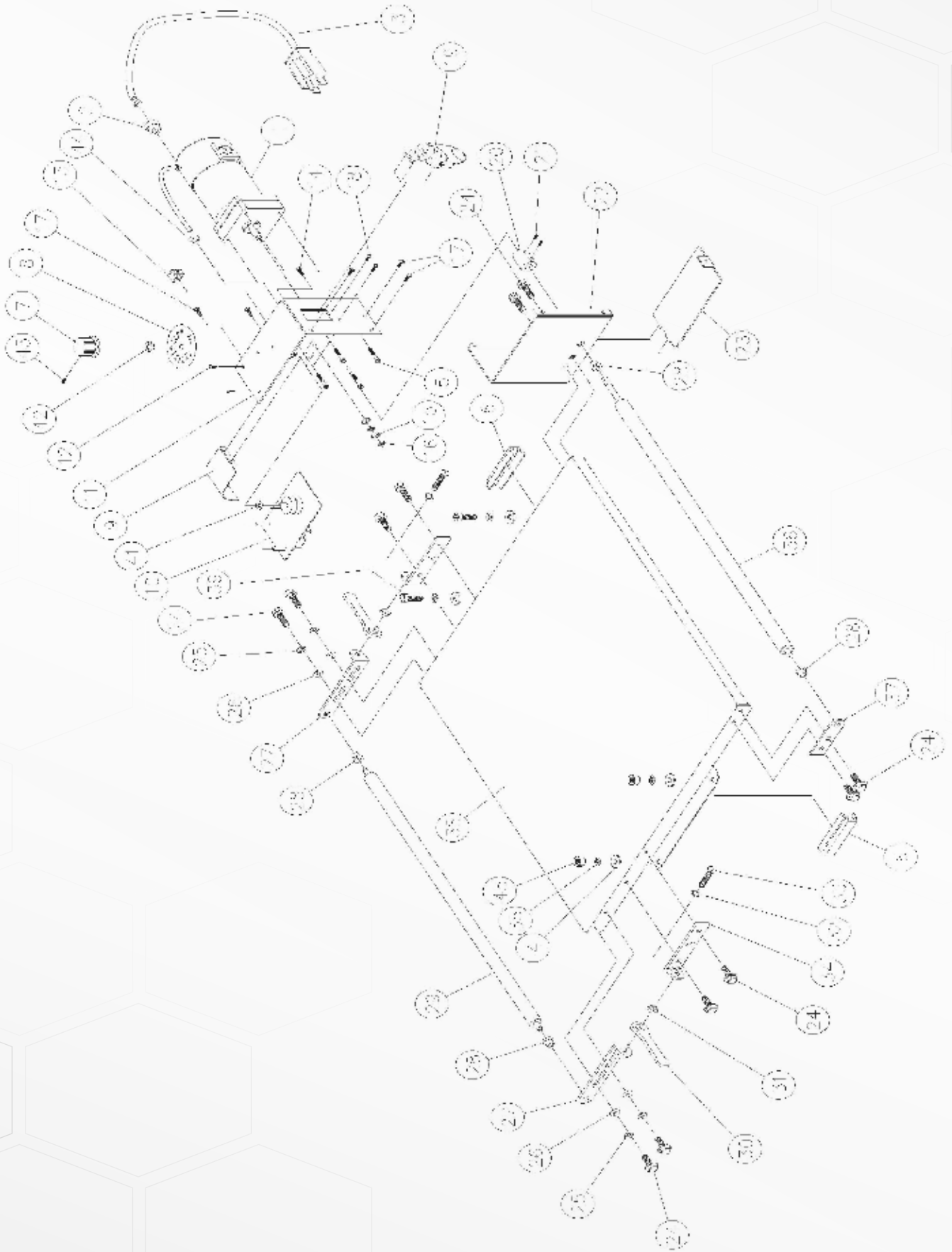



SuperMax
Tools

SuperMaxTools.com - sales@SuperMaxTools.com

P. 1-888.454.3401 - F. 1-651.454.3465

