

# 2023 FY250C

**VIPER**  
LIFT TRUCKS



## STANDARD FEATURES

- 5,000lb Base Capacity
- 3 Stage Mast
- Full Free Lift
- 84" Lowered Mast Height
- 189" Max Raised Fork Height
- Premium Traction Cushion tires
- EPA Tier 4 Final Kubota 2.5L LPG Engine
- Engine Features 4cyl 61 HP @1600 RPM and 126 ft/lb TQ @1800 RPM
- Backup Alarm
- Rear View Mirrors
- LED Front and Rear Lights
- Integrated LED Turn Signals
- Tilt Steering Column
- Twin USB Power Ports for Electric personal or Business Devices
- Digital Systems Monitor Display
- Rubber Floor mat
- Load Backrest
- 3 Way Hydraulics Plumbed to Carriage
- 12mo/2000hr Manufacturer Warranty







# 2023

# FY250

## SPECIFICATIONS

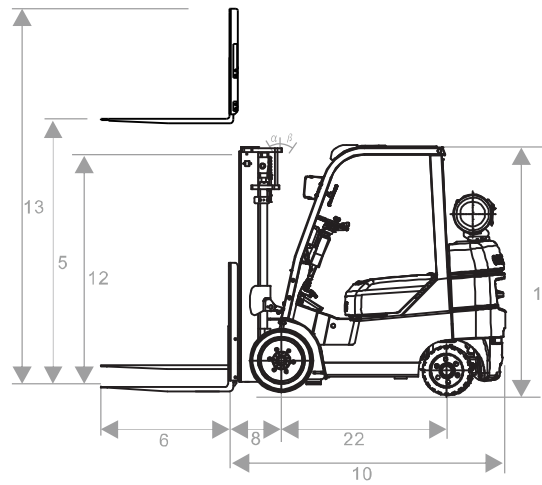
POWER TYPE	LPG	<b>LPG (OPTIONAL DUAL FUEL)</b>
BASE CAPACITY	<b>5000 LBS</b>	
CAPACITY 24" LC @189"	<b>3900 LBS</b>	
SERVICE WEIGHT	<b>9041 LBS</b>	
TIRE SIZE (FRONT)	<b>21x7x15</b>	
TIRE SIZE (REAR)	<b>16.25x6x11.25</b>	
WHEELBASE	<b>55.1"</b>	
MAST TILT ANGLE (F/R)	<b>6/12</b>	
LIFT HEIGHT (3 STAGE)	<b>189"</b>	
LOWERED HEIGHT	<b>84"</b>	
FREE LIFT	<b>73"</b>	
LENGTH (LESS FORKS)	<b>95"</b>	
WIDTH	<b>45"</b>	
HEIGHT TO OVERHEAD GUARD	<b>82"</b>	
TURNING RADIUS	<b>83"</b>	
GROUND CLEARANCE	<b>3.14"</b>	
MAX GRADABILITY	<b>20%</b>	
TRANSMISSION	<b>AUTO</b>	
TRANSMISSION SPEEDS	<b>1 FWD / 1 RVS</b>	



 RASA: Right-Angle Stack Aisle  
 a: Safety Clearance  
 b: Length of Loading  
 v: Turning radius (inside)

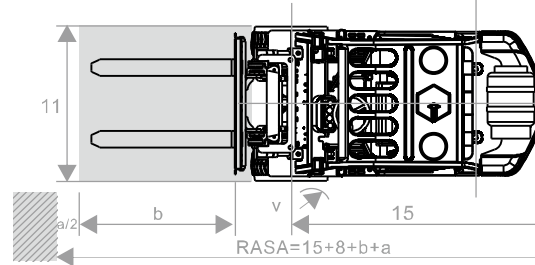

Engine model may vary



**VIPER**  
LIFT TRUCKS

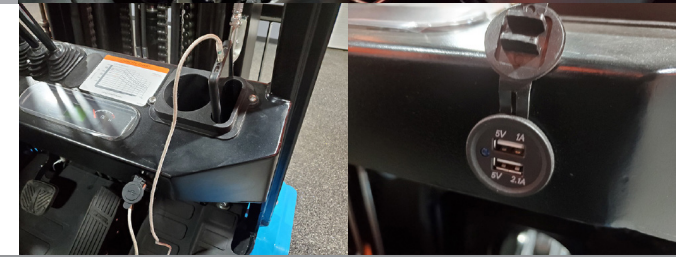

# 2023

# FY250

## PICK YOUR COLOR!

**ORANGE**



**RED**

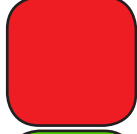

**GREEN**

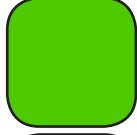

**ACID GREEN**



**SKY BLUE**



**ROYAL BLUE**



**SILVER**



**FROST GREY**

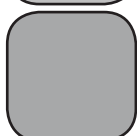

## FACTORY INSTALLED OPTIONS\*

DUAL FUEL ENGINE

SIDE SHIFTER

SIDE SHIFT FORK POSITIONER

FULL SUSPENSION SEAT

CAB W/HEAT, WIPERS, LED LIGHTS

AIR CONDITIONING

DUAL AIR FILTER (N/A W/ CAB)

VERTICAL EXHAUST

FIRE EXTINGUISHER

STROBE LIGHT

REAR WORK LIGHT

4TH VALVE, LEVER AND HOSEING

REAR HORN HANDLE/BUTTON

EATON STEERING



**EXTENDED WARRANTIES AVAILABLE  
INQUIRE WITH YOUR REPRESENTATIVE  
FOR FURTHER DETAILS**

**VIPER**  
LIFT TRUCKS

WWW.VIPERLIFTTRUCKS.COM





VIPER

VIPER  
LIFT TRUCKS

25

VIPER  
LIFT TRUCKS  
GENUINE PARTS

VIPER  
LIFT TRUCKS

GENUINE PARTS

VIPER  
LIFT TRUCKS

GENUINE PARTS

VIPER  
LIFT TRUCKS

GENUINE PARTS

OIL FILTER