

BUCKETLESS HANDLE BWMS-16 Instruction Sheet

Included:

1. Handle Assembly
2. Dispensing Bottle
3. Instruction Sheet
4. Frame (Velcro®)
5. Chemical Identification Labels Sheet

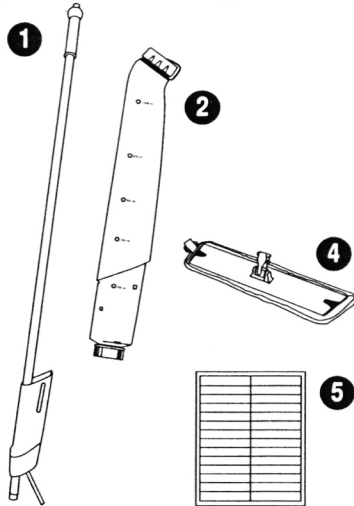
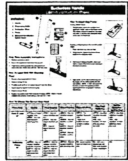

First Time Assembly Instructions:

1. Remove contents of carton
2. Assure all components listed above are present
3. Place threaded collar on handle
4. Insert handle stem into yoke and align holes
5. Insert locking ring
6. Tighten threaded collar

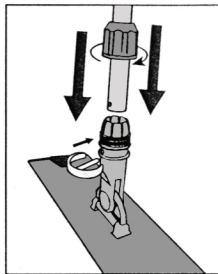

How To Load Unit With Cleaning Fluid:

1. Remove dispensing bottle from holster
2. Remove gray fill cap
3. Fill bottle to 32 oz fill line (or desired amount if less than 32 oz)
4. Assure cleaning solution is diluted properly
5. Replace gray fill cap
6. Replace dispensing bottle firmly yet gently to holster. **NOTE:** Bottle is not fully engaged and properly seated until you hear and feel a "click".

How To Attach Mop Frame:

If using Velcro® frame:

1. Carefully place correct size and type of head against the Velcro® strips on the bottom of frame. This is best achieved by laying the mop head face down on the floor then placing the frame evenly upon the mop head.

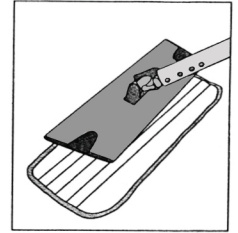

If using a collapsing frame with pocket mops:

1. Place mop frame face down on floor.
2. Using your foot, depress the frame release button on the collapsing frame
3. With frame in collapsed position, place each "end" or "wing" of the frame at each opening of the mop head pockets.

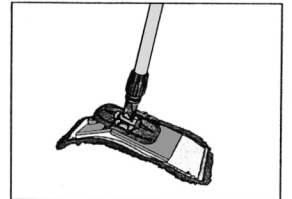
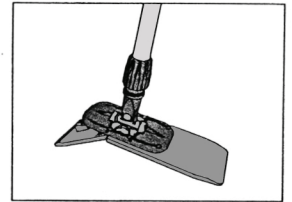

4. Apply gentle, but firm downward pressure to the handle until the frame extends into both mop pockets. **NOTE:** A "click" will signify that the frame is locked into operating position, assuming both ends are properly inserted to mop pockets.

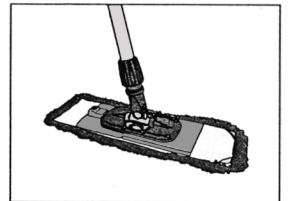

How To Chose The Correct Mop Head

| Frame Style | Dusting | Damp Mopping | Deeper Cleaning | Floor Finish Application | Staining Application Concrete Floor |
|-------------------------------------|--|--|---|--|--|
| Hook & Loop 18" | MFD185G-F - Microfiber dry dust mop with fringe green with hook and loop backing | MFM185B-CF - blue microfiber wet pad SLM185 - Spun loop microfiber wet mop SIM185 - white Antimicrobial microfiber wet pad MFSP185 - Power Scrub microfiber pad | MFSP185 - Power Scrub microfiber pad orange MFPM185 - Pleated microfiber pad blue SLM185 - Spun loop microfiber wet mop | MAP185 - Microfiber finish pad white and blue striped with hook and loop backing | MAP185 - Microfiber finish pad white and blue striped with hook and loop backing |
| Collapsing Frame 16" | N/A | SLM185PKT - Spun loop microfiber wet mop with pocket backing | SLM185PKT - Spun loop microfiber wet mop with pocket backing | N/A | N/A |

How To Operate

1. Assure the correct cleaning solution is properly loaded into dispensing bottle and that dispensing bottle is correctly loaded into the holster. **NOTE:** Consult your MSDS Right to Know Center before using chemicals. Affix the corresponding Chemical Identification Label to the dispensing bottle. (Be sure to consult full label copy and MSDS prior to use.)
2. Assure proper mop head has been chosen and that it is correctly attached to a properly installed frame. (see chart)
3. Be sure to have your room prepared by removing all furnishings, posting a Wet Floor sign, and properly dust mopping the floor to be cleaned.
4. Use proper PPE's (Personal Protective Equipment).
5. Choose a spot in the room that is furthest from the door you will be exiting. With frame and mop head on the floor, depress the orange valve button once to turn the solution flow valve on until enough fluid is discharged to provide an initial "wetting" of your mop head. **Push button again to turn the solution flow valve off. Flow will stop when button is pressed a second time. Operation is similar to a ball point pen.**
NOTE: The click-on, click-off feature is designed to reduce user fatigue when a constant flow of fluid is desired.
6. Frame the area you wish to clean, return to the starting point and work your way toward the intended exit door working the frame in a figure 8 motion, being certain to effectively overlap each pass to ensure an even clean.
7. Reapply fluid to the floor and subsequently to the mop head by depressing the orange valve button as needed.
8. Return unit to storage area. See How To Clean, Maintain and Store After Use instructions below.

How To Clean, Maintain and Store After Use

1. Remove mop head and place in laundry bag (if launderable) or in trash if disposable.
2. Remove dispensing bottle from holster by pulling upward firmly, yet gently.
3. Dispensing bottle is sealed and may be stored in dedicated storage area.
NOTE: Always read and follow chemical label instructions.
4. If dispensing bottle is empty, rinse out dispensing bottle by removing both top (orange) and bottom caps and allow clean water to flow. Most chemistries call for a triple rinse.
5. Bring handle to water source and with gray valve button locked "on" rinse water through the holster/valve assembly.
6. Using a clean, dry microfiber towel, wipe down the entire unit.
7. If dispensing bottle is clean and empty, replace to holster. **NOTE:** We recommend purchasing extra dispensing bottles to allow for more efficient cleaning programs and multiple cleaning chemical changes.
8. Store handle on wall via our Tool Holder or the integrated handle hook. **NOTE:** Do not hang unit by bottle tether. Bottle may become disengaged and cause damage to unit.
9. Extra dispensing bottles may be stored by hanging them by their integrated storage hook onto a properly anchored edge / shelf / lip.

Trouble Shooting Guide

| Symptom | Solution |
|--|---|
| Frame falls off handle | Ensure swivel connector tabs on mop frame have "clicked" into the receiving holes on the handle. |
| Valve will not dispense | Confirm that dispensing bottle is firmly "clicked" into holster. Is dispensing bottle filled with chemistry? Is orange valve button fully depressed? Is dispensing tube kinked or clogged? |
| Valve will not turn off | Ensure that orange valve button is not in locked-on position. |
| Dispensing bottle will not properly seat or "click" into place | Is there any debris inside holster? Is dispensing bottle button cap installed? Is dispensing bottle button cap tight? Is dispensing bottle in holster backward? |
| Frame does not swivel 360° | Is swivel locked engaged? Is frame properly mounted to handle? |

Replacement Parts

| | |
|-----------------|-----------------------------|
| BWMS-VK | Valve Kit |
| BWMS-T | Tether without Cap |
| BWMS-TC | Tether and Large Bottle Cap |
| BWMS-CV | Bottom Bottle Cap Valve |
| BWMS-BTC | Bottle with Tether and Caps |

