

Rope Swing Owner's Manual



www.ravesports.com

Table of Contents

Introduction	2
Safety Rules and information	3
Inflation valve operation.....	6
Assembling your Rope Swing	7
Attachments for Rope Swing.....	12
Assembling your Free Standing Rope Swing.....	13
Using your Rope Swing.....	18
Securing your Rope Swing.....	19
Cleaning, storage and repairs	20
Limited one year warranty	21

Contents of the Rope Swing (2 boxes):

- 1 Inflatable base tube w/ 4 frame post pads
- 1 Inflatable platform
- 1 Platform Bridge for Rope Swing to AJ25 (#02606 Sold separate)
- 4 Platform mounting pins with retaining rings
- 11 Steel frame pieces
- 28 Bolts
- 2 M6 hex wrenches
- 1 Rope swing
- 1 Repair kit

Date Purchased: _____

Purchased from: _____

Serial Number: _____

(Serial # is located next to the inflation valve on the tube.)

Copyright ©

All rights reserved. No part of this publication may be reproduced or transmitted in any form or by any means, electronic or mechanical, including photocopy, recording, or any information storage and retrieval system, without permission in writing from the publisher. Requests should be mailed to RAVE Sports, 3325 Labore Rd., St. Paul, MN 55110.

Introduction

Thank you for purchasing a RAVE Sports ® Rope Swing. This Owner's Manual is presented to enhance your enjoyment of the sport and is intended to alert you to some of the potentially dangerous conditions that can arise in all water sports. It also contains important safety instructions and information about how to assemble, use and care for your product.

Please take a few minutes to read this manual before assembling and using the product. Although the product is simple to use, this manual contains important safety information that you and all users must understand to safely enjoy the Rope Swing.

Make sure that everyone who uses the product also receives proper education and supervision and understands the safety instructions and warnings presented in this manual. Be sure to save this manual for future reference.

IMPORTANT: When using Rope Swing...

...As an "attachment" it can connect to:

AJ 150 - #00150

AJ 200 - #00200

Bongo 15 - #02012

Bongo 20 - #020 20

AJ 25 – **Note: Order Platform Bridge #02606 in order to connect**

...With:

Activity Island - #02412 – **Need both Boarding Platform(# 02416) & Access Ramp(#02413)**

...As a free standing unit:

Needs both Boarding Platform - # 02416 & Access Ramp - # 02413

Do not install or use in any other manner than its designed use.

If you have any questions regarding this product, please call RAVE Sports at 1-800-659-0790. Please have your serial number available.

W A R N I N G

**UNSAFE USE OF THE ROPE SWING
CAN RESULT IN PERSONAL INJURY OR
DEATH.**

To reduce the risk of injury, read and follow all instructions and warnings in this manual. Do not use this product unless you understand and accept the risk of injury involved with this activity.

Safety Rules and Information

- Read and understand all of the information contained in this owner's manual before assembling and using your product.
- Make sure that everyone who uses the product is provided with and understands these safety rules and information.
- The Rope Swing is designed to be used only while secured to approved RAVE devices in large bodies of water with depths of at least 10 feet of water. Do not use or allow anyone else to use the product on land or any other hard surface or in swimming pools.
- Choose a location for your product that is most protected from wind, of sufficient water depth, and free of obstructions.

- Always anchor the unit securely before it is used.
- Always make sure the Rope Swing is attached securely to the base unit (Aqua Jump, Bongo or Activity Island with Access Ramp) before using.
- Do not attach to docks, piers or any other object not specifically designed for use with the Rope Swing.
- Always wear a U.S. Coast Guard approved Type III (PFD) vest when using the Rope Swing.
- Never use the product after sunset, before dawn, or any other time in poor lighting conditions.
- Never use the product in rough surface water conditions, during storms, or when there is lightning. If an unexpected storm arises while using the product, seek shelter on shore. Do not stay on the product.
- Never use the product under the influence of alcohol or drugs.
- Always stay under control while using the product.
- Allow only one person on the Rope Swing at a time.
- To avoid the possibility of a collision, make sure the swing path and landing area is clear of obstructions and other swimmers before each use.
- Do not attempt to swing in a standing position. Swing in a seated position only and release at the furthest point away from the platform.
- To avoid contact with the metal frame, swing straight out and release immediately at the furthest point away from the structure. Do not swing back and forth.

- Do not climb or stand on rope or rope swing structure. Stand on swing entrance platform only.
- Never swim or play under or around the Rope Swing while others are using the product.
- Do not use without the safety pads in place.
- Never use the product while tired or fatigued. Use extreme caution while swimming between the shore and the product. Do not attempt to swim this distance if you are tired or fatigued.
- Always inspect the areas around and under the product before each use to ensure the water is deep enough and free of all rocks, logs, sand bars, and underwater obstructions and that the product is a safe distance from above water hard objects. Ask about local water conditions before using the product in unfamiliar water.
- Inspect your product for any worn, defective, or missing parts. Do not use if there are any signs of damage, wear or deterioration.
- Do not attempt flips, somersaults or other acrobatic maneuvers on the product. Always enter the water feet first.
- Not recommended for children under the age of six.
- Use the Rope Swing only under mature, knowledgeable adult supervision.
- Always exercise caution and common sense while using the Rope Swing. Reckless behavior may result in serious injury.
- When not in use, secure the product against unauthorized or unsupervised use.

Liability

While every attempt is made to embody the highest degree of protection in all equipment, we cannot guarantee freedom from injury. The user assumes all risk of injury due to use. All merchandise is sold on this condition, which no representative of the company can waiver or change.

Inflating any RAVE Waterpark Attachment

We highly recommend using the RAVE High Speed Inflator/Deflator. It will provide rapid inflation/deflation and will achieve optimum air pressure in your RAVE product. (Part # 01083 not included).

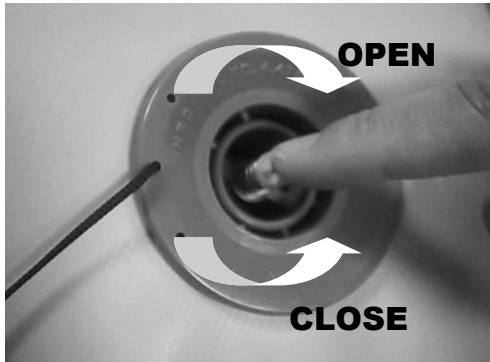

To lock open valve, depress stem and rotate $\frac{1}{4}$ turn clockwise. To close valve, depress stem and rotate $\frac{1}{4}$ turn counter-clockwise. The valve stem should be in the depressed position while inflating. Replace cap on valve after inflation to ensure air tight seal.

If you are using the RAVE Sports High Speed Inflator (P/N 01083), simply lock the adaptor onto the end of the inflation hose and insert into the valve body. Turn $\frac{1}{4}$ turn to lock in place.



NOTE: This inflation adaptor will automatically open the valve when inserted and will close the valve when removed. You do not need to manually open/close the valve when using this special adaptor.

IMPORTANT: A PROPERLY INFLATED TUBE WILL FEEL LIKE A FIRMLY INFLATED BASKETBALL.

To Deflate:

Rapid deflation can be achieved using the “deflate” side of the motor housing. Attach the hose to the deflate side of the motor housing and lock the valve adaptor into the valve. Turn on deflator and let run until all air is evacuated from the tube.



CAUTION

DO NOT USE AN AIR COMPRESSOR TO INFLATE THIS PRODUCT. USE OF AN AIR COMPRESSOR MAY CAUSE OVER-INFLATION, WHICH CAN DAMAGE OR RUPTURE SEAMS, THUS VOIDING THE WARRANTY.

IMPORTANT:

It is normal for the air pressure within air filled tubes to fluctuate depending on air and water temperatures. It may be necessary to increase or decrease the air pressure in your product accordingly. To avoid damage on extremely hot days it may be necessary to check and release the air pressure from your product throughout the day.

Connecting Rope Swing to a RAVE Aqua Jump or Bongo:

Assembly Instructions

Step 1: Unpack the contents.

Lay the inflatable base tube on a flat surface. Make sure there are no sharp objects under the product that might puncture the material.



Step 2: Attach inflatable platform to base tube

Orient the grey inflatable platform on top of the base tube so the non-slip tread area is towards the legs of the base tube.

Align all four platform connecting mounts so they fit together like the hinge of a door and insert pins into the mounts. Secure the pins in place with the retaining clips.

Tip: Place pin into mount so the tether line is coming straight out at you. This will orient the holes in the pin for easy clip insertion in the bottom of the pin. Insert clips onto pins, ensuring both ends of the clip are securely inserted into the holes on both sides of the pin.



Step 3: Inflation

See inflation and valve operation on p. 6.

Inflate base tube until very firm then inflate the platform until also firm.

Step 4: Assemble frame

Lay out frame components as shown.

Refer to diagram on next page and note final orientation of frame pieces.

Insert both pieces of section B into the ends of section A. Orient so the short legs are pointing upwards and angled slightly towards each other. Insert bolts and hand tighten only at this time.

Insert frame pieces C into the other end of section B. Insert bolts and hand tighten.

Insert frame pieces D into the other ends of C. Insert bolts and hand tighten. At this time, frame pieces A, B, C & D should all be laying flat on the ground.

Insert frame pieces E into the angled, short ends of section B. Insert bolts and hand tighten. Lastly, insert frame pieces F into the ends of section E. Insert bolts and hand tighten.

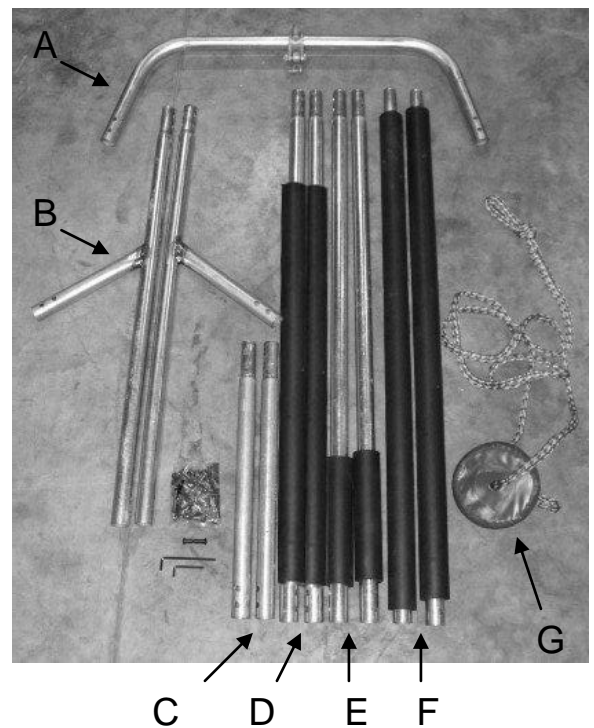

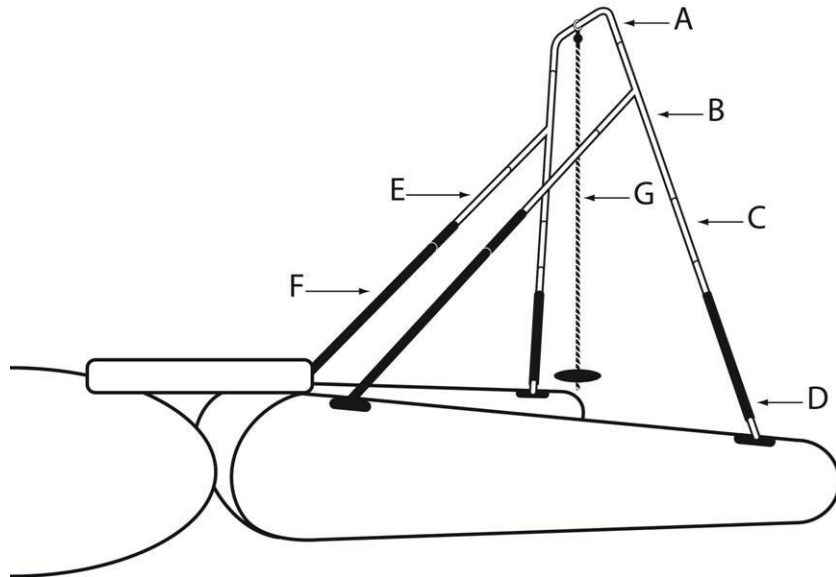

Illustration of frame pieces assembled.

While the frame is still lying on the ground, attach the rope assembly (G) to the pivot mount on the bottom of frame section A. Insert the bolt through the center of the nylon bearing. Attach lock washer and nut to end of bolt and tighten securely.



Tighten all frame bolts securely using the M6 hex wrenches provided.

Step 5: Carry tube to water

Remove protective caps from frame posts. Retain these caps for use later during deflation and off-season storage of the Rope Swing.

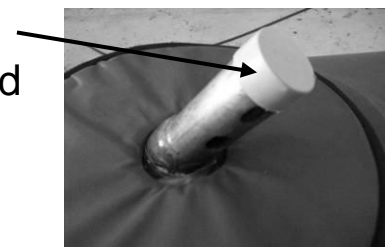

NOTE: Make sure the protective pad remains in place and covers the base plate of the frame posts.

Carry, DO NOT DRAG, base tube to the water's edge.

Step 6: Install frame onto base tube.

Using 3-4 people, tip up the frame and carry it to the inflated base tube utilizing one person on each leg of the swing frame.

First, insert the frame onto the frame posts nearest to the swing platform. Make sure the frame pipes are fully inserted down onto the posts.



Next, insert the remaining two ends of the frame onto the frame posts at the far ends of the base tube.

NOTE: If the frame is too difficult to push onto the outer posts, release some air in the base tube. This will allow the posts to move freely and align with the frame pipes.

Once the frame is installed onto the posts, insert all remaining bolts and tighten securely. Re-inflate the base tube, if necessary, until firm. Slide black foam sleeves down to completely cover the lower bolts and all exposed steel on the lower section of the frame.

Step 7: Connect Rope Swing to Aqua Jump or Bongo

Float the assembled Rope Swing out to the Aqua Jump water trampoline or Bongo.

Choose a side to mount the Rope Swing that provides adequate clearance to swing into the water that is 10 feet or deeper.

There are three straps coming off the underside of the Rope Swing platform. Feed the ends of these three straps underneath the spring cover pad on the water trampoline and to the inside of the Aqua Jump tube. On the Bongo, feed the straps through the openings in the jump surface lacing.



Take the single strap that is on the frame side of the Rope Swing tube, run it underneath the Aqua Jump tube and loosely connect it to the center buckle strap coming from the platform.

Take the two straps coming from the Aqua Jump or Bongo side of the Rope Swing tube, run them underneath the Aqua Jump or Bongo and loosely connect them to the outer two buckle straps coming from the platform.

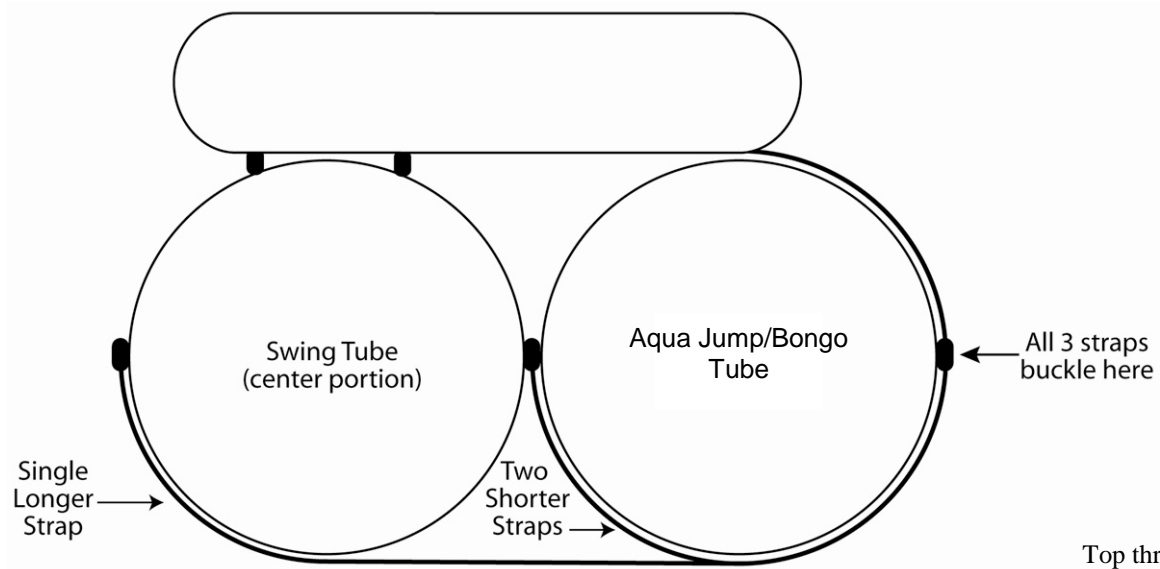
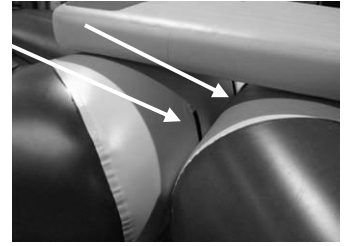

Tighten all three straps securely; making sure the Rope Swing tube is pulled tight against the Aqua Jump or Bongo tube.

Center strap comes from frame side of swing base tube.

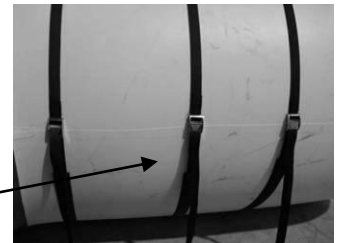

NOTE: Same connection method as shown above. To connect the Classic AJ25 to Rope Swing, one will need item# **02606 Platform Bridge for Rope Swing to AJ25 (SOLD SEPARATELY)**

HOW TO CONNECT ROPE SWING TO AJ25 INTERFACE

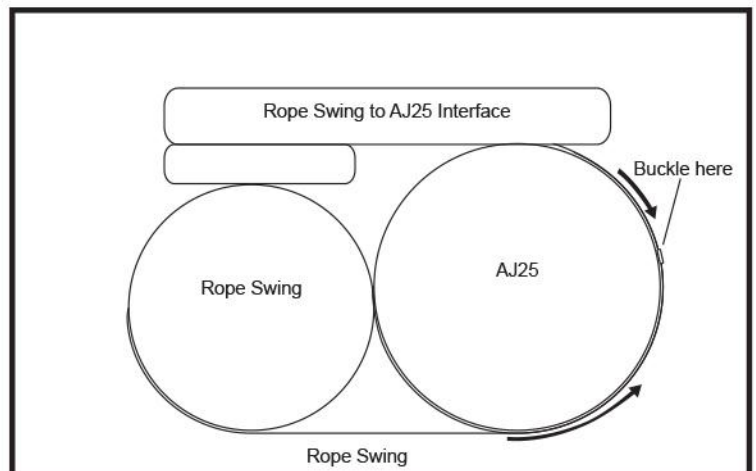

Anchoring:

An optional anchor attachment point is located below the equator on the Aqua Jump or Bongo side of the Rope Swing tube. Attach an anchor here for additional stability and to prevent the wind from swinging the product to an undesirable direction.

The Rope Swing is now ready for use!



How to Set Up a Free Standing Rope Swing

Two critical items are needed in order to use the Rope Swing as a free standing unit:

- **Boarding Platform-**
Item # 02416
Sold Separately



- **Access Ramp-**
Item # 02413
Sold Separately

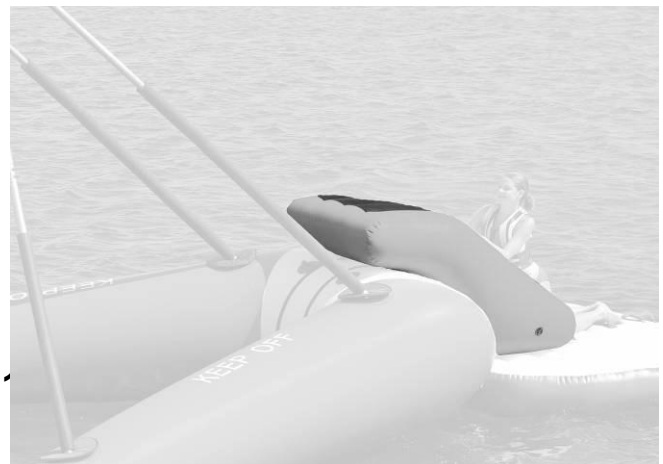

IMPORTANT: Do not attempt to use the Rope Swing as a free standing unit without these two devices being attached!

CONNECTING ACCESS RAMP TO BOARDING PLATFORM

IMPORTANT: FIRST FOLLOW STEPS 1-6 ON ROPE SWING ASSEMBLY (SKIP STEP 2 WHEN SETTING UP FREE STRANDING ROPE SWING AS THE GREY PLATFORM IS NOT USED IN THIS CONFIGURATION)



Step 1

Before inflating the Access Ramp and Boarding Platform, lay the inflatable on a flat surface. Make sure there are no sharp objects under the product that might puncture the material.

Step 2

Locate the valve and start inflating. See inflating and valve operation on page 6. Inflate both Access Ramp and Boarding Platform until they are firm like a basketball.

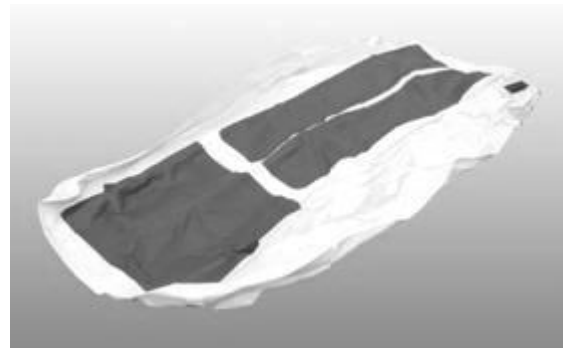

Step 3

Align the rings on the sloped end of the Access Ramp with the two rings on top of the Boarding Platform.

Step 4

Feed strap through the ring on the Boarding Platform in the direction of the Access Ramp, then pull upwards to the ring on the Access Ramp.



Step 5

Feed through the backside of the top ring. Pull strap downward and fasten to itself. **Important:** Ensure the strap is fastened across the entire length of the Velcro. Repeat for second strap.



Step 6

There are four straps on the lower portion of the Access Ramp.



Take the two outside straps and feed them upwards through the ring that is on the side of Boarding Platform. Then feed it through the ring at the starting point of the strap.

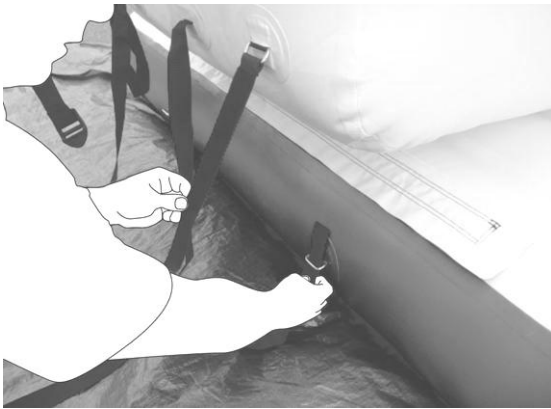

Step 7

Pull down on the strap and Velcro it down tight. Ensure the strap is fastened along the entire length of Velcro.



Step 8

Repeat the same steps 6-7 for the opposite strap. Once both straps are fastened, check and make sure both are secure.

Carry assembled Access Ramp and Boarding Platform to shallow water.

DO NOT DRAG!

How to Connect the Rope Swing to the Access Ramp and Boarding Platform

NOTE: There are three straps connected to the Rope Swing center tube section. These straps are not used when connecting the Rope Swing to the Activity Island. Roll up the straps and secure with a rubber band or similar device so they are not in the way when attaching to the Activity Island.



Step 1

While in shallow water, float the assembled Rope Swing next to the Boarding Platform with the Access Ramp already mounted.

Step 2

There are two buckle straps at the top of the Access Ramp. Run these over the top of the Rope Swing tube.

Feed the two long lower middle straps around the bottom side of the Rope Swing Tube and through the buckles on the upper straps. Pull tightly to secure the Access Ramp tightly to the Rope Swing tube.

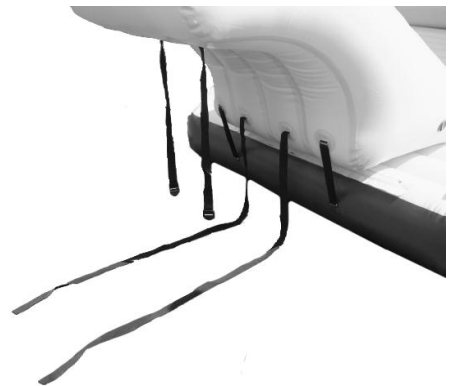

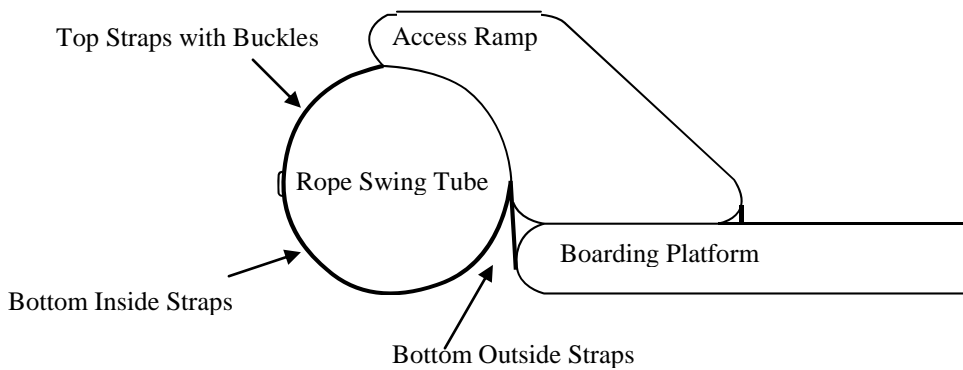

Ensure the Rope Swing, Access Ramp and Boarding Platform are securely fastened together.

Float out to desired position on the water. Ensure there is a least 10 feet of water depth where the Rope Swing is to be anchored and used.

Anchoring a Free Standing Rope Swing:

There are four anchor points available for the Free Standing Rope Swing. There are 3 points on the Rope Swing base tube and one on the Board Platform. Attach an anchor to these points for stability and to prevent the wind from swinging the product to an undesirable direction.

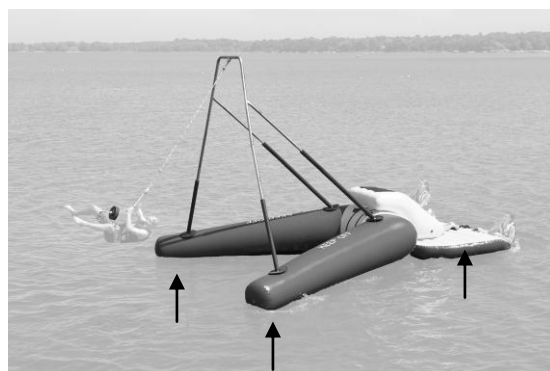

The Free Standing Rope Swing is now ready for use!

Using the Rope Swing:

The hook located on the lower front portion of the grey platform provides easy access to the rope during initial use.

Slowly and carefully walk out to the edge of the swing platform and unhook the rope from the front of the platform.

If the rope is not attached to the hook and is out of reach from the platform, have someone in the water swing it towards the person on the platform.



CAUTION! DO NOT WALK ALONG THE TOP OF THE BASE TUBE TO RETRIEVE THE ROPE AS THIS SURFACE MAY BE SLIPPERY.

CAUTION! Make sure the swing path is clear of other swimmers or other obstructions before attempting to swing.

Stand as close as possible to the platform edge and grab as high as possible onto the rope. Swing out using your arms and catch the seat between your legs so you are sitting on the disk while swinging.

Release from the Rope Swing at the furthest point out, landing feet first into the water.

After landing in the water, swim towards the rope and grab onto the bottom knot. Swing the rope up to the next person in line on the platform. Immediately swim out of the way so the next person can swing.

Securing the Rope Swing against unwanted use:

The Rope Swing can be easily locked to prevent unsupervised use. Use a light chain or short cable (not included) approximately 11" long and a weather-resistant padlock.

Feed the chain/cable through the small loop at the bottom of the rope and wrap it around the swing frame at the base. Insert the lock through the chain/cable to secure.



IMPORTANT: In order to prevent potential injury, remove lock assembly completely from the Rope Swing prior to using.

Cleaning and Storage

- When the inflatable product is not being used, store it in a covered, shaded area. This will help protect it against ultraviolet (UV) rays and extend the life of the product.
- Clean the inflatable completely with a mild soap and fresh water. **NEVER USE PETROLEUM BASED PRODUCTS OR SOLVENTS FOR CLEANING. NEVER USE A POWER WASHER SINCE THE HIGH PRESSURE WATER JET WILL DAMAGE THE TUBE BEYOND REPAIR.**
- Product should be completely dry and remain dry while stored.
- Ensure the protective caps are installed onto the frame posts. Roll the product loosely and place in a container, preferably one that rodents can't chew through.
- Disassemble entire frame and store separately from the tube.
- Secure against unauthorized or unsupervised use.
- Store in a cool, dry location. Do not store product directly on concrete surface. Place mothballs around stored inflatable to keep mice and insects away.

..... **Important**

Rodents like muskrats may be attracted to the PVC vinyl of your product. When your product is on the water, maintaining full air pressure during periods of non-use will discourage them from chewing the vinyl. Another way to ease the problem of nuisance rodents is to remove the temptation by taking the product out of the water at night. You can also make the whole area unattractive to rodents by changing the environment, making the area less hospitable for rodents. Removing any food source from the shoreline can also be a good deterrent. Check with your local DNR for additional guidance or possible restrictions.

Repairs

For large holes, tears or seam failures, contact RAVE Sports at 1-800-659-0790.

For minor holes or tears:

- Inflate the product and locate the leak by spraying the tube with mild soapy water.
- Determine the hole size and cut a patch 1-2 inches wider than the diameter of the hole. Make sure all corners of the patch are rounded.
- Deflate the product and clean the patch and area around the hole with rubbing alcohol. Let dry.
- **READ AND UNDERSTAND THE WARNINGS ON THE GLUE CONTAINER.**
- Apply glue to the patch and the area around the hole. Let the glue dry until it is tacky to the touch.
- Lay the product on a flat, hard surface and apply the patch. Working from the center to the outer edge, rub out any air bubbles between the patch and the product.
- Let patch dry for 24 hours before attempting to inflate the product.

Limited 1 Year Warranty

The Limited 1 Year Warranty set forth below is given by RAVE Sports, A Revel Match, LLC Company with respect to product(s) purchased and used in the United States and internationally.

RAVE Sports' product(s), when delivered to you in a new condition in original container, are warranted against defects in material or workmanship for a period of one (1) year from the date of original purchase when used in a non-commercial application. Product(s) used in a commercial application are warranted against defects or workmanship for a period of six (6) months from the date of original purchase. Defective product(s) returned to RAVE Sports or authorized service location and proven to be defective upon inspection, will be repaired or exchanged for new product(s) or part(s) where applicable. The warranty period for any replacement product shall begin upon shipment of the same, but shall in no event exceed the warranty period of the defective product.

When returning any product under this Limited 1 Year Warranty, you must first contact RAVE Sports to obtain a return authorization number. The product must be packaged in its original carton or similar packaging with a copy of the bill of sale (or invoice of purchase), together with a complete explanation of the problem. Shipping charges, if any, must be prepaid. Products covered by this Limited 1 Year Warranty will be returned to you without charge by RAVE Sports.

This Limited 1 Year Warranty covers all defects encountered in normal use of the product and does not apply in the following cases:

- a) Loss or damage due to abuse, mishandling, alteration, accident
- b) Failure to follow operating, maintenance, or storage instructions
- c) Service by a party other than RAVE Sports' authorized service personnel
- d) Any acts of God including storm, and animal damage
- e) The product has had its serial number(s) or dating altered or removed
- f) Normal wear and tear which includes sun damage and other normal weathering of the product

No implied warranty (or condition), including any implied warranty (or condition) of merchantability or fitness for a particular purpose, applies to the product after the applicable period of express warranty stated above, and no other express warranty or guaranty, except as mentioned above, given by any person, firm, or corporation with respect to the product shall bind RAVE Sports. (Some states or provinces do not allow limitations on how long an implied warranty lasts, so the above limitations may not apply to you).

RAVE Sports shall not be liable for loss of revenue or profit, failure to realize savings or other benefits, or for any other special, incidental or consequential damages caused by the use, misuse or inability to use the product regardless of the legal theory on which the claim is based, and even if RAVE Sports has been advised of the possibility of such damages. Nor shall recovery of any kind against RAVE Sports be greater in amount than the purchase price of the product sold by RAVE Sports and causing the alleged damage.

Without limiting the foregoing, you assume all risk and liability for loss, damage or injury to you and your property and to others and their property arising out of the use, misuse, or inability to use any product sold by RAVE Sports not caused directly by the negligence of RAVE Sports, (Some states or provinces do not allow the exclusion or limitation of incidental or consequential damages, so the above limitation may not apply to you). This Limited 1 Year Warranty shall not extend to anyone other than the original purchaser of any product, or the person for whom it was purchased as a gift.

This Limited 1 Year Warranty gives you specific legal rights, and you may have other rights which vary from state to state or province to province.



www.ravesports.com

RAVE Sports

A Revel Match, LLC Company

3325 Labore Road

Saint Paul, MN 55110

May 2014