

TRUBRITE™ WHITEBOARDS

Price Effective - January 1, 2022

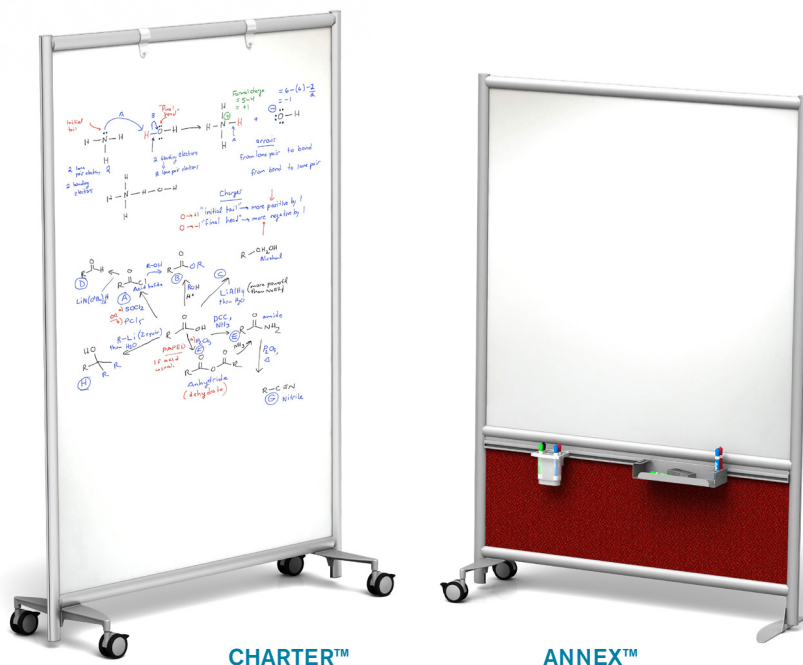

MOBILE DRY ERASE WHITEBOARD

Engineered to be lightweight, durable and mobile, our TruBrite Whiteboards are designed and built to share ideas. Our high-quality TruBrite dry-erase writing surface is non-ghosting, easy to clean and economical. TruBrite Whiteboards are available in 2 contemporary aluminum frame designs with mobile or free-standing foot options.

- Framework is constructed using aluminum extrusion
- All metal parts are anodized, or powder coated for an aesthetic and durable finish
- Our metal mobile feet have 3" locking casters
- Nesting frame design allows for easy space-saving storage
- TruBrite™ dry erase surface is non-ghosting and easy to clean
- Made in the USA

How to build your SKU:

Step 1:
Choose your Model

3SL

Step 2:
Choose your Width

49

Step 3:
Choose your Height

54

Step 4:
Choose your Frame Color

BK

Step 5:
Choose your Foot Option

4

Step 6:
Choose your Dry Erase Material

WB

Step 6:
Choose your Lower Core Material (Annex - 3SL only)

P103

(Annex - 3SL only)

TRUBRITE™ WHITEBOARDS

Model	Width	Height	Frame Color	Foot Options	Dry Erase Materials	Lower Core Materials (Annex - 3SL only)
2XM Charter™	30"	48"	AA Satin Aluminum	4 4 Wheel	WB TruBrite™ Whiteboard (Both Sides)	FRO Frosted Acrylic
3SL Annex™	37"	54"	BK Black	F Freestanding	WBF1_ TruBrite™ (Side 1)/ Fabric 1_ (Side 2)	A1_ Colored Frosted Acrylic
	42"	62"			WBF2_ TruBrite™ (Side 1)/ Fabric 2_ (Side 2)	WB TruBrite™ Whiteboard (Both Sides)
	49"	72"			F1_ Fabric 100 Series	
	61"				F2_ Fabric 200 Series	
	73"				WBF1_ TruBrite™ (Side 1)/ Fabric 1_ (Side 2)	WBF2_ TruBrite™ (Side 1)/ Fabric 2_ (Side 2)

TRUBRITE™ WHITEBOARDS - CHARTER™

Width	Height	Weight (lbs)	WB	FOOT OPTIONS
			TruBrite™ Whiteboard	4 Wheel or Freestanding
30"	48"	19	\$690	+\$200
30"	54"	20	\$725	+\$200
30"	62"	23	\$1,110	+\$200
30"	72"	25	\$1,165	+\$200
37"	48"	21	\$805	+\$200
37"	54"	23	\$835	+\$200
37"	62"	26	\$1,160	+\$200
37"	72"	29	\$1,215	+\$200
42"	48"	23	\$870	+\$200
42"	54"	25	\$900	+\$200
42"	62"	28	\$1,190	+\$200
42"	72"	31	\$1,255	+\$200
49"	48"	25	\$915	+\$200
49"	54"	28	\$950	+\$200
49"	62"	31	\$1,245	+\$200
49"	72"	35	\$1,305	+\$200



CHARTER™
(Model 2XM)
Full Panel Dual-Sided Dry Erase Board

Accessories Available for Charter Model (Sold Separately)	SKU	Price
-----------------------------------------------------------	-----	-------

Flip Chart Clip Set
(quantity 2)



FCC \$30

NOTE:

All pricing in USD

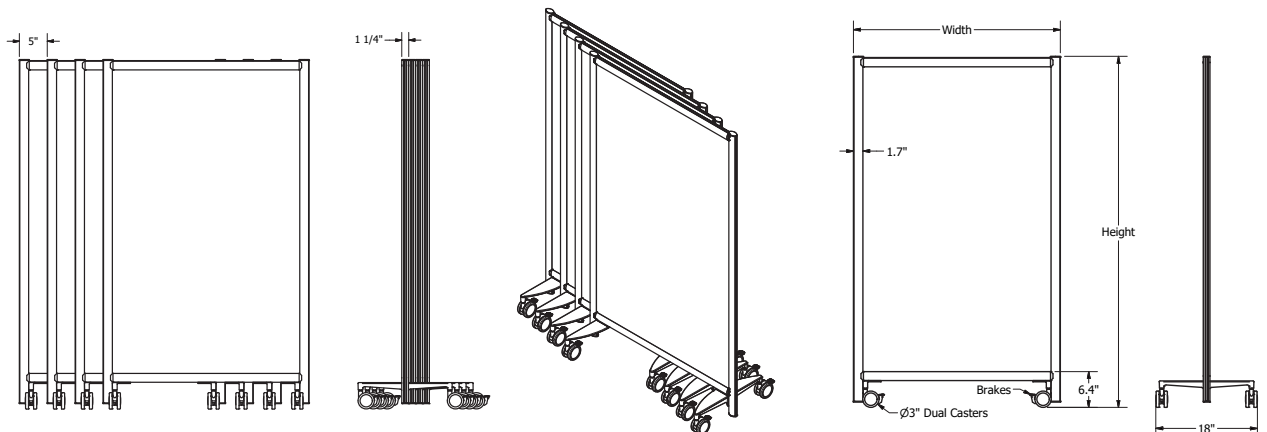

ANNEX™
 (Model 3SL)
 Dual-Sided Dry Erase
 Whiteboard and
 Lower Customized Panel with
 Slatwall Accessory Rail



UPPER CORE - TRUBRITE™ (BOTH SIDES)

LOWER CORES

**FOOT
OPTIONS**

Width	Height	Weight (lbs)	FRO	A1_	WB	F1_	F2_	WBF1_	WBF2_	P1_	L1_	4 Wheel or Freestanding
			Frosted Acrylic	Colored Frosted Acrylic	TruBrite™ Whiteboard	Fabric 100 Series	Fabric 200 Series	WB/Fabric 100 Series	WB/Fabric 200 Series	Echo-Scape™ 3/8" (9mm)	Laminate 100 Series	
37"	54"	26	\$970	\$1,035	\$965	\$995	\$1,025	\$995	\$1,025	\$925	\$1,045	+\$200
37"	62"	28	\$1,075	\$1,140	\$1,070	\$1,100	\$1,130	\$1,100	\$1,130	\$1,030	\$1,150	+\$200
37"	72"	31	\$1,135	\$1,200	\$1,130	\$1,160	\$1,190	\$1,160	\$1,190	\$1,090	\$1,210	+\$200
49"	54"	32	\$1,090	\$1,160	\$1,075	\$1,120	\$1,160	\$1,120	\$1,160	\$1,030	\$1,185	+\$200
49"	62"	35	\$1,240	\$1,310	\$1,225	\$1,270	\$1,310	\$1,270	\$1,310	\$1,180	\$1,335	+\$200
49"	72"	39	\$1,310	\$1,380	\$1,295	\$1,340	\$1,380	\$1,340	\$1,380	\$1,250	\$1,405	+\$200
61"	54"	37	\$1,575	\$1,720	\$1,580	\$1,580	\$1,635	\$1,580	\$1,635	\$1,505	\$1,660	+\$200
61"	62"	41	\$1,625	\$1,770	\$1,630	\$1,630	\$1,685	\$1,630	\$1,685	\$1,555	\$1,710	+\$200
61"	72"	46	\$1,695	\$1,840	\$1,700	\$1,700	\$1,755	\$1,700	\$1,755	\$1,625	\$1,780	+\$200
73"	54"	44	\$1,675	\$1,820	\$1,675	\$1,730	\$1,795	\$1,730	\$1,795	\$1,600	\$1,850	+\$200
73"	62"	49	\$1,730	\$1,875	\$1,730	\$1,785	\$1,850	\$1,785	\$1,850	\$1,655	\$1,905	+\$200
73"	72"	54	\$1,805	\$1,950	\$1,805	\$1,860	\$1,925	\$1,860	\$1,925	\$1,730	\$1,980	+\$200

UPPER CORE - TRUBRITE™ (SIDE 1) / FABRIC 1_ (SIDE 2)

LOWER CORES

**FOOT
OPTIONS**

Width	Height	Weight (lbs)	FRO	A1_	WB	F1_	F2_	WBF1_	WBF2_	P1_	L1_	4 Wheel or Freestanding
			Frosted Acrylic	Colored Frosted Acrylic	TruBrite™ Whiteboard	Fabric 100 Series	Fabric 200 Series	WB/Fabric 100 Series	WB/Fabric 200 Series	Echo-Scape™ 3/8" (9mm)	Laminate 100 Series	
37"	54"	26	\$1,065	\$1,130	\$1,060	\$1,090	\$1,120	\$1,090	\$1,120	\$1,020	\$1,140	+\$200
37"	62"	28	\$1,185	\$1,250	\$1,180	\$1,210	\$1,240	\$1,210	\$1,240	\$1,140	\$1,260	+\$200
37"	72"	31	\$1,250	\$1,315	\$1,245	\$1,275	\$1,305	\$1,275	\$1,305	\$1,205	\$1,325	+\$200
49"	54"	32	\$1,195	\$1,265	\$1,180	\$1,225	\$1,265	\$1,225	\$1,265	\$1,135	\$1,290	+\$200
49"	62"	35	\$1,360	\$1,430	\$1,345	\$1,390	\$1,430	\$1,390	\$1,430	\$1,300	\$1,455	+\$200
49"	72"	39	\$1,455	\$1,525	\$1,440	\$1,485	\$1,525	\$1,485	\$1,525	\$1,395	\$1,550	+\$200
61"	54"	37	\$1,725	\$1,870	\$1,730	\$1,730	\$1,785	\$1,730	\$1,785	\$1,655	\$1,810	+\$200
61"	62"	41	\$1,785	\$1,930	\$1,790	\$1,790	\$1,845	\$1,790	\$1,845	\$1,715	\$1,870	+\$200
61"	72"	46	\$1,865	\$2,010	\$1,870	\$1,870	\$1,925	\$1,870	\$1,925	\$1,795	\$1,950	+\$200
73"	54"	44	\$1,860	\$2,005	\$1,860	\$1,915	\$1,980	\$1,915	\$1,980	\$1,785	\$2,035	+\$200
73"	62"	49	\$1,925	\$2,070	\$1,925	\$1,980	\$2,045	\$1,980	\$2,045	\$1,850	\$2,100	+\$200
73"	72"	54	\$2,015	\$2,160	\$2,015	\$2,070	\$2,135	\$2,070	\$2,135	\$1,940	\$2,190	+\$200

TRUBRITE™ WHITEBOARDS - ANNEX™

			UPPER CORE - TRUBRITE™ (SIDE 1) / FABRIC 2_ (SIDE 2)									FOOT OPTIONS
			LOWER CORES									
Width	Height	Weight (lbs)	FRO	A1_	WB	F1_	F2_	WBF1_	WBF2_	P1_	L1_	
			Frosted Acrylic	Colored Frosted Acrylic	TruBrite™ Whiteboard	Fabric 100 Series	Fabric 200 Series	WB/Fabric 100 Series	WB/Fabric 200 Series	Echo- Scape™ 3/8" (9mm)	Laminate 100 Series	4 Wheel or Freestanding
37"	54"	26	\$1,125	\$1,190	\$1,120	\$1,150	\$1,180	\$1,150	\$1,180	\$1,080	\$1,200	+\$200
37"	62"	28	\$1,235	\$1,300	\$1,230	\$1,260	\$1,290	\$1,260	\$1,290	\$1,190	\$1,310	+\$200
37"	72"	31	\$1,300	\$1,365	\$1,295	\$1,325	\$1,355	\$1,325	\$1,355	\$1,255	\$1,375	+\$200
49"	54"	32	\$1,300	\$1,370	\$1,285	\$1,330	\$1,370	\$1,330	\$1,370	\$1,240	\$1,395	+\$200
49"	62"	35	\$1,450	\$1,520	\$1,435	\$1,480	\$1,520	\$1,480	\$1,520	\$1,390	\$1,545	+\$200
49"	72"	39	\$1,525	\$1,595	\$1,510	\$1,555	\$1,595	\$1,555	\$1,595	\$1,465	\$1,620	+\$200
61"	54"	37	\$1,805	\$1,950	\$1,810	\$1,810	\$1,865	\$1,810	\$1,865	\$1,735	\$1,890	+\$200
61"	62"	41	\$1,865	\$2,010	\$1,870	\$1,870	\$1,925	\$1,870	\$1,925	\$1,795	\$1,950	+\$200
61"	72"	46	\$1,950	\$2,095	\$1,955	\$1,955	\$2,010	\$1,955	\$2,010	\$1,880	\$2,035	+\$200
73"	54"	44	\$1,955	\$2,100	\$1,955	\$2,010	\$2,075	\$2,010	\$2,075	\$1,880	\$2,130	+\$200
73"	62"	49	\$2,025	\$2,170	\$2,025	\$2,080	\$2,145	\$2,080	\$2,145	\$1,950	\$2,200	+\$200
73"	72"	54	\$2,120	\$2,265	\$2,120	\$2,175	\$2,240	\$2,175	\$2,240	\$2,045	\$2,295	+\$200

Accessories Available for Annex Model (Sold Separately)

Flip Chart Clip Set
(quantity 2)



FCC

\$30

Pen Cup - Rail Series



S-PC

\$30

Marker Tray - Rail Series



S-WBTR

\$70

NOTE:

All pricing in USD

Uses Slatwall Accessories

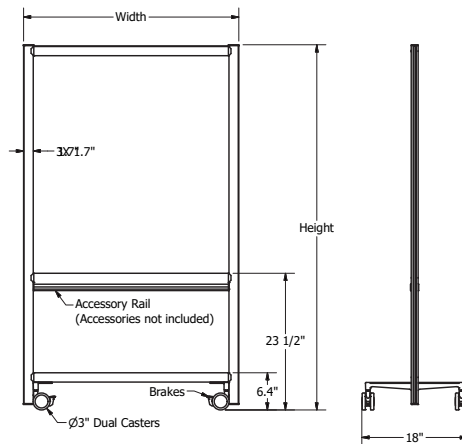

MATERIAL OPTIONS

ECHOSCAPE™ 3/8" (9MM)



Snow
P114



Oat
P116



Cocoa
P121



Sunflower
P111



Tangerine
P109



Ruby
P108



Aqua
P115



Pear
P103



Moss
P120



Spruce
P123



Sky
P117

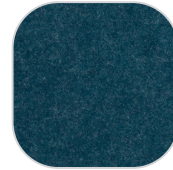

Denim
P118



Cobalt
P102



Midnight
P119

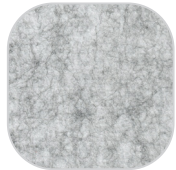

Iced Grey
P106



Ash
P100



Slate
P105



Charcoal
P101



Jet
P122

FABRICS 100 SERIES

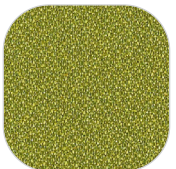

Gaia
F101

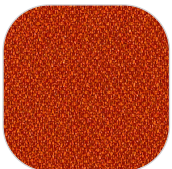

Mikan
F103

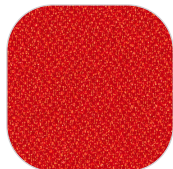

Poppy
F104

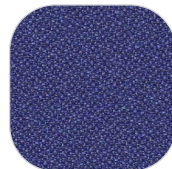

Euro
F102



Sapphire
F114



Sodalite
F108

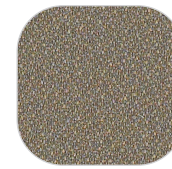

Arundel
F112

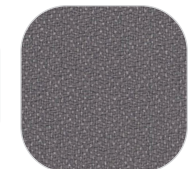

Iron
F121



Stately
F113



Steel
F120



Basalt
F122



Jet
F123

FABRICS 200 SERIES



Barley
F210



Sable
F211



Java
F212

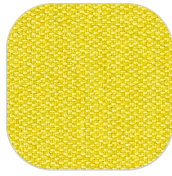

Lemongrass
F213

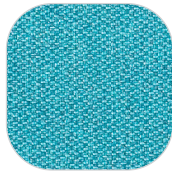

Rinse
F214

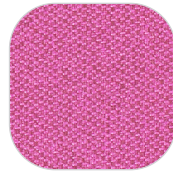

Radiant
F215

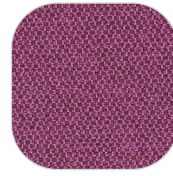

Tyrian
F216



Hyacinth
F217

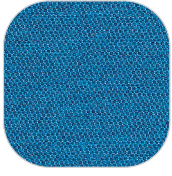

Capri
F218

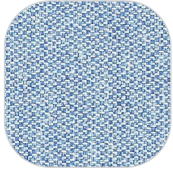

Aster
F219

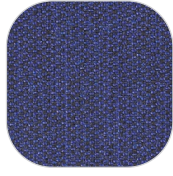

Beyond
F220



Stucco
F221



Aluminum
F222



Dove
F223

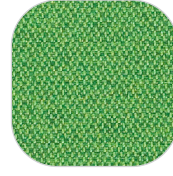

Links
F224



Atoll
F225

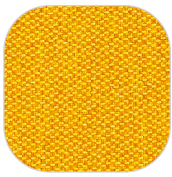

Maize
F226

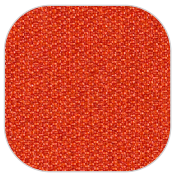

Papaya
F227

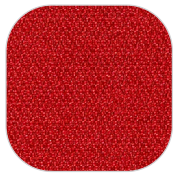

Macintosh
F228



Berry
F229



Gull
F230

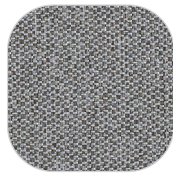

Pewter
F231

FROSTED ACRYLICS



Frosted Acrylic
FRO



Dark Blue
A10



Light Blue
A11



Lime Green
A12



Moss Green
A13



Yellow
A14



Orange
A15



Red
A16



Pink
A17

LAMINATES



Phantom Ecu
L100



Soft Gold Mesh
L101



Fusion Maple
L120



New Age Oak
L102



Huntington Maple
L118



Windswept Bronze
L103



Black Walnut
L104



Cafelle
L107



Grey Elm
L121



Bleached Legno
L105



Asian Night
L119



Smokey Brown Pear
L106



Blackened Legno
L108



Brite White
L109



Folkstone
L110

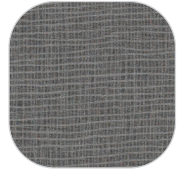

Citadel Warp
L111

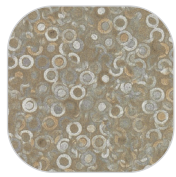

Beluga Beige
L112



White Drops
L113

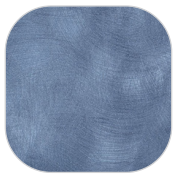

Woolamai Brush
L114



Blue Agave
L115



Hollyberry
L116



Clementine
L117



Antique Cognac Pine
L300



Recon Olive
L301



Repurposed Oak Plank
L302



Small Planked
L303



Mocha Olive
L304



Lost Pine
L305



Antique Barrel
L306



Reclaimed Oak Plank
L307

FRAMES



Satin Aluminum
AA



Black
BK