

# SWITCHIT™ DESK DIVIDER PANELS

Price Effective - September 19, 2022

## POP-OFF - TURN PANEL - POP-ON

SwitchIT™ acoustic desk panels can be mounted above the desk for a quiet, distraction free work zone, or instantaneously converted to an open workstation for collaborative work with our patented magnetic mounting system.

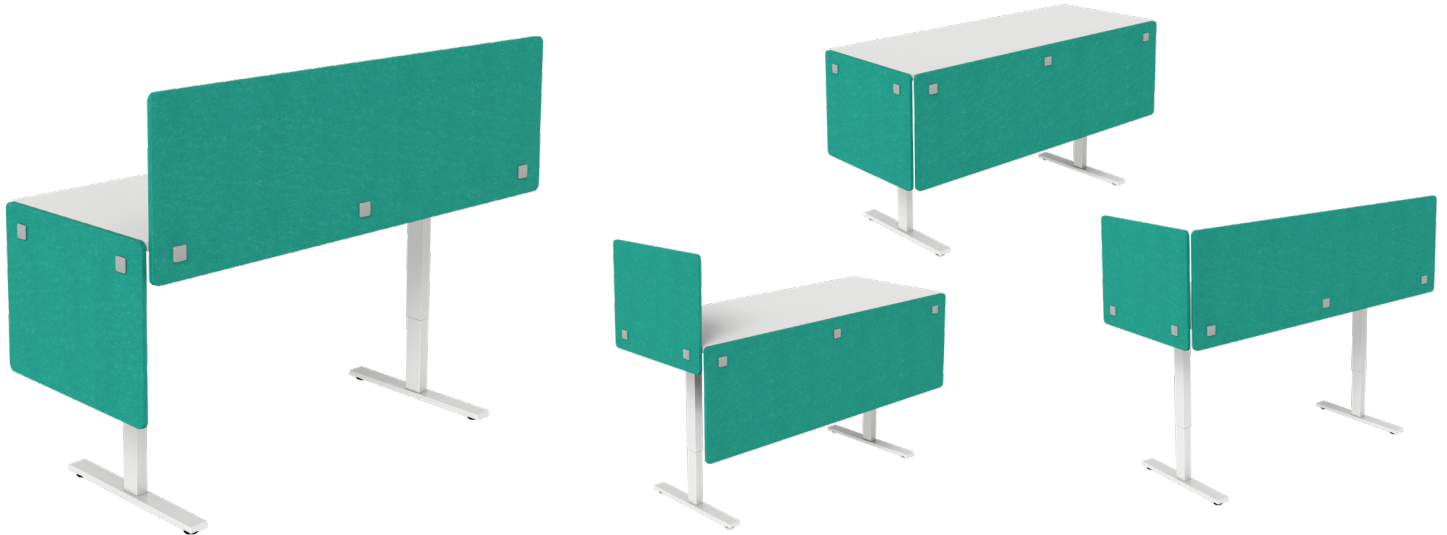

## IMMEDIATELY ADJUST YOUR WORKSPACE

- Instantly repurpose for a private or collaborative workspace - no tools needed
- Available in several widths
- Available in 2 heights:
  - 24" panel height - 18" Above 1.25" worksurface
    - 0" Switched height above worksurface
  - 30" panel height - 18" Above 1.25" worksurface
    - 6" Switched height above worksurface
- NRC rated acoustic EchoScape™ material available in 2 thicknesses
  - 3/4" (18mm), NRC rated up to 0.9 – available in 8 colors
- Patented magnet mount assembly merges with most furniture solutions
- Panels can be used on any worksurface thickness
- Magnet mounts are permanently mounted to bottom of worksurface and on panels for secure stability
- Panels can be mounted flush against the desk or with up to a 1" gap to allow for wire management
- EchoScape™ panels are lightweight, tackable, VOC-free, 100% recyclable
- Custom sizes and shapes available

### How to build your SKU:

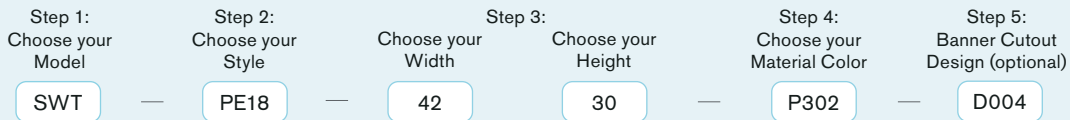

## SWITCHIT™ PANEL

Model	Style	Width	Height	Fixed and Switched Height above worksurface	Material Color	Banner Cutout Designs (optional)
SWT SwitchIT™ Panel	PE18 EchoScape™ 3/4" (18mm)	24"	24"	18" Above 1.25" worksurface, 0" Switched Height above worksurface	P300 Ash EchoScape™ 3/4" (18mm)	D002 Fizzy
		30"	30"	18" Above 1.25" worksurface, 6" Switched Height above worksurface	P301 Charcoal EchoScape™ 3/4" (18mm)	D004 Metro
		36"			P302 Cobalt EchoScape™ 3/4" (18mm)	D005 Dash
		42"			P303 Pear EchoScape™ 3/4" (18mm)	D008 Tribal
		48"			P304 Sandstone EchoScape™ 3/4" (18mm)	D016 Retro
		54"			P305 Slate EchoScape™ 3/4" (18mm)	D017 Strata
		60"			P306 Iced Grey EchoScape™ 3/4" (18mm)	D021 Maze
		66"			P316 Oat EchoScape™ 3/4" (18mm)	D022 Aztec
		72"				D023 Pinwheel

# SWITCHIT™ PANEL - INSTALLATION OPTIONS

## OPTION 1

24" Panel Height

18" Height above  
worksurface

0" Switched  
Height above  
worksurface

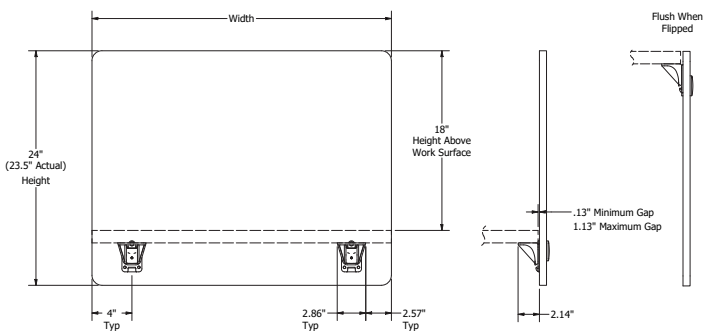

## OPTION 2

30" Panel Height

18" Height above  
worksurface

6" Switched  
Height above  
worksurface

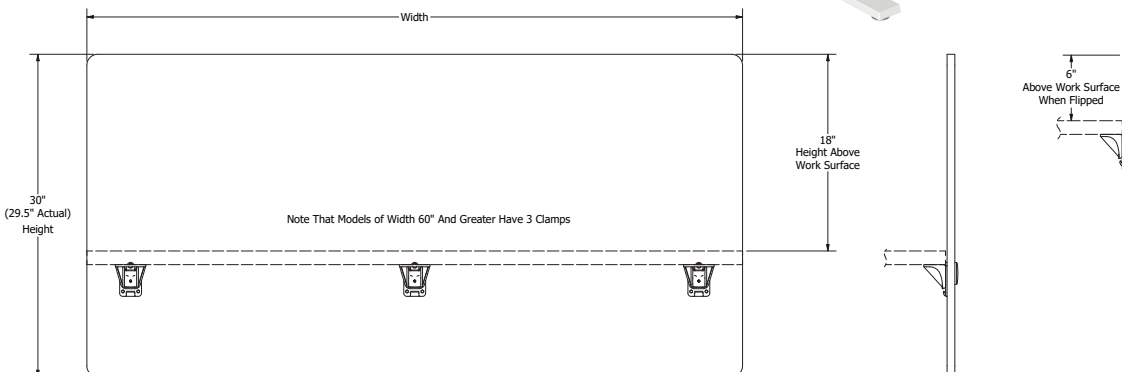

PANEL AND MOUNTING SET

Width	Height	SWT-PE18 3/4" (18mm) List Price	Banner Cutout Design (optional)	Number of Mounting Sets
24"	24"	\$258	+\$33	2
24"	30"	\$268	+\$33	2
30"	24"	\$268	+\$44	2
30"	30"	\$312	+\$44	2
36"	24"	\$312	+\$44	2
36"	30"	\$377	+\$44	2
42"	24"	\$377	+\$55	2
42"	30"	\$388	+\$55	2
48"	24"	\$388	+\$55	2
48"	30"	\$410	+\$55	2
54"	24"	\$410	+\$66	2
54"	30"	\$476	+\$66	2
60"	24"	\$446	+\$66	3
60"	30"	\$511	+\$66	3
66"	24"	\$610	+\$77	3
66"	30"	\$631	+\$77	3
72"	24"	\$626	+\$77	3
72"	30"	\$642	+\$77	3



## MOUNTING SYSTEM



### SWITCHIT™ MAGNETIC MOUNT MOUNTS TO WORKSURFACE

Patented Mounting System



### SWITCHIT™ MAGNETIC MOUNT MOUNTS TO PANEL

Patented Mounting System

## DESIGN CUTOUTS

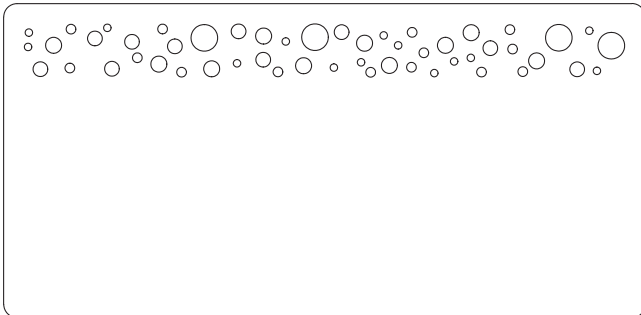

D002 - FIZZY

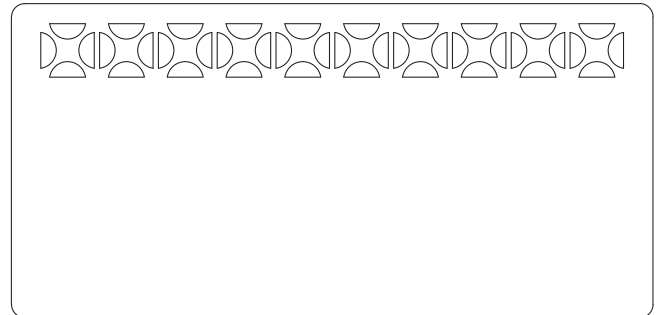

D004 - METRO

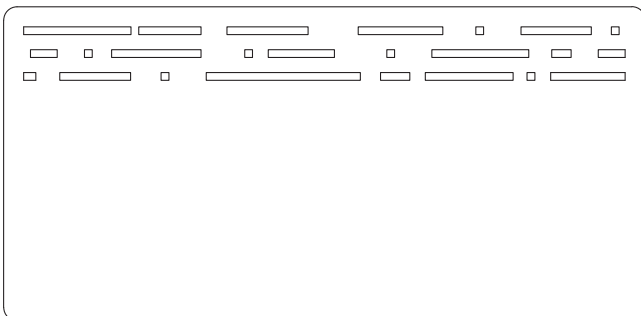

D005 - DASH

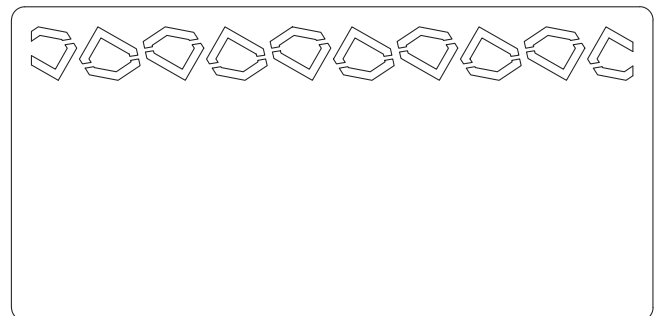

D008 - TRIBAL

# DESIGN CUTOUTS

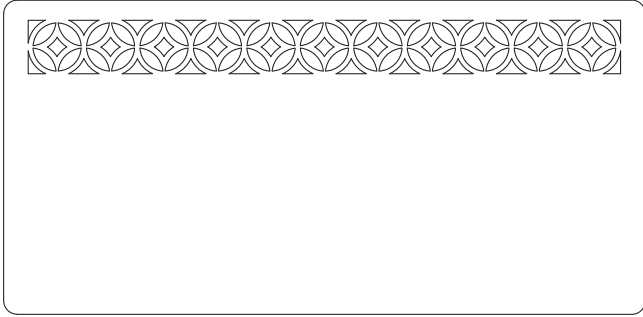

D016 - RETRO

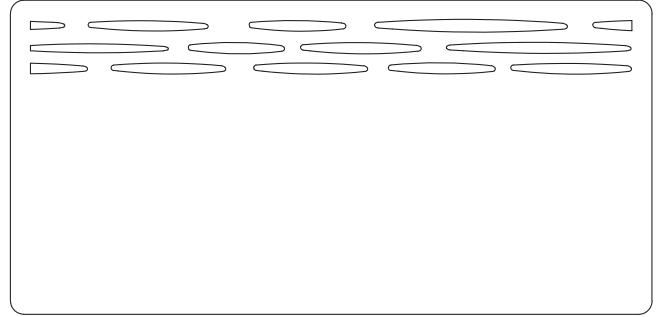

D017 - STRATA

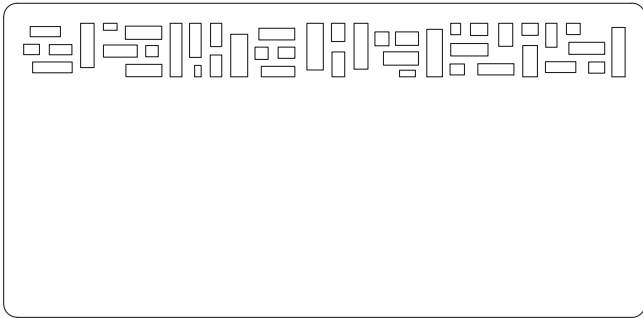

D021 - MAZE

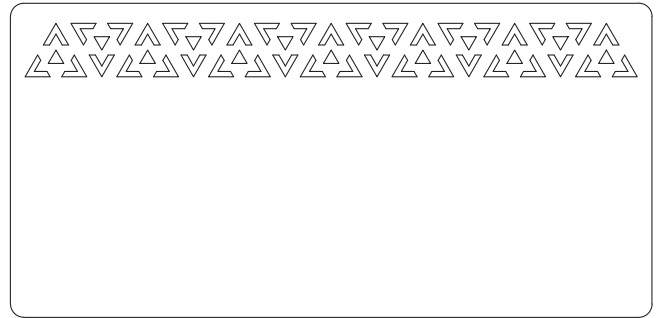

D022 - AZTEC

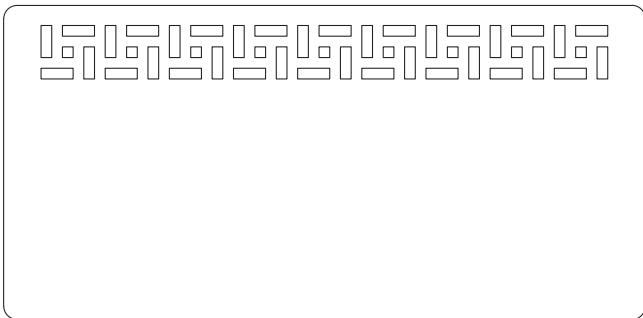

D023 - PINWHEEL

## MATERIAL OPTIONS

### ECHOSCAPE™ 3/4" (18MM)



Oat  
P316



Sandstone  
P304



Pear  
P303



New  
Spruce  
P323



New  
Denim  
P318



Cobalt  
P302

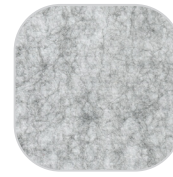

Iced Grey  
P306



Ash  
P300



Slate  
P305



Charcoal  
P301