

ECHODECO® BLADE CEILING TILES

Price Effective -September 19, 2022

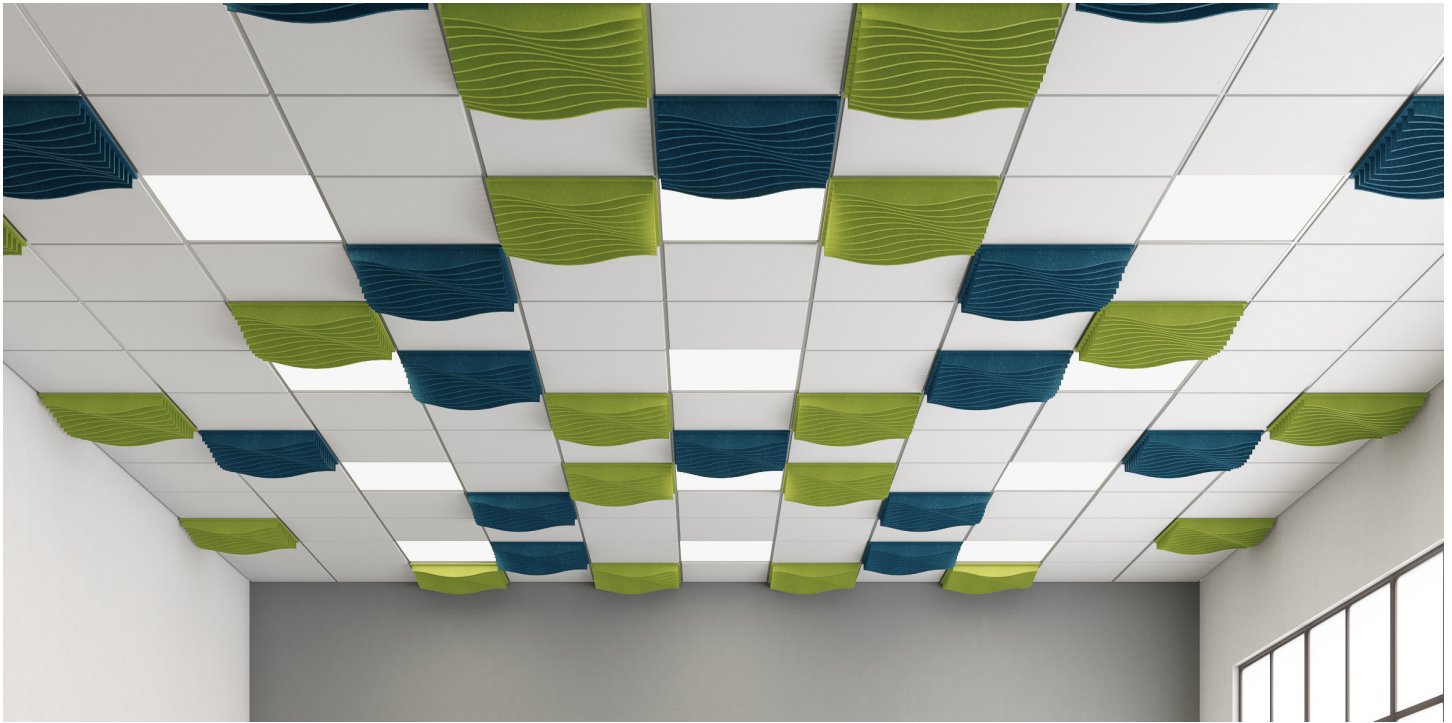

ACOUSTIC CEILING ART INSTANTLY

What does your space need most, acoustic comfort or an updated look? EchoDeco® Blade Ceiling Tiles deliver both; a high impact design while reducing annoying noise. EchoDeco Blade Ceiling three-dimensional tiles drop easily into your existing 2' x 2' ACT grid and cost-effectively transform your ceilings into interesting and artistic compositions that absorb noise.

Packed with an acoustic punch, each 2' x 2' tile contains 10 square feet of highly rated acoustic material that immediately get to work. 22 colors, 6 Blade designs, and options for 1 or 2 colors on each tile, EchoDeco Blade Ceiling Tiles deliver an effective and fast acoustic and decorative solution.

- Tile dimension: 23.75" square
- 6 three-dimensional design options
- EchoDeco Ceiling Tile thickness - 3/8" (9mm) with an NRC rating of 0.85.
- Custom designs available
- Easy installation
- Made in the USA

How to build your SKU:

Step 1: Choose your Model	Step 2: Choose your Design	Step 3: Choose your Color Option
EBCT-24	REC	P106
	OR	
EBCT-24	REC	TP106 + BP111
		<small>One Color Option</small> <small>Two Color Option</small> <small>Color One - Tile</small> <small>Color Two - Blades</small>

ECHODECO® BLADE CEILING TILES

Model	Fixed Size	Design	Color Options	
			One Color	Two Colors
EBCT-24 EchoDeco® Blade Ceiling Tiles	23.75"W x 23.75"H	REC Rectangle DIA Diagonal A1P Angle 1 Progressive A2P Angle 2 Progressive W1P Wave 1 Progressive W2P Wave 2 Progressive	P1_ EchoScape™ 3/8" (9mm)	TP1_ Tile Color + BP1_ Blade Color EchoScape™ 3/8" (9mm)

ECHODECO® BLADE CEILING TILES - QTY 1
MATERIAL THICKNESS 3/8" (9MM)

EBCT

Width	Height	Weight (lbs)	Tiles Qty 1 (one or two colors) List Price	Acoustic Material Square Footage
23.75"	23.75"	4	\$262	10 sq. ft.

COLOR OPTIONS

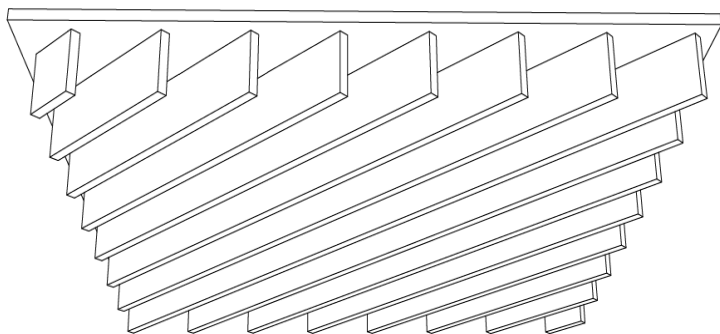

**ONE COLOR
OPTION**
P1__

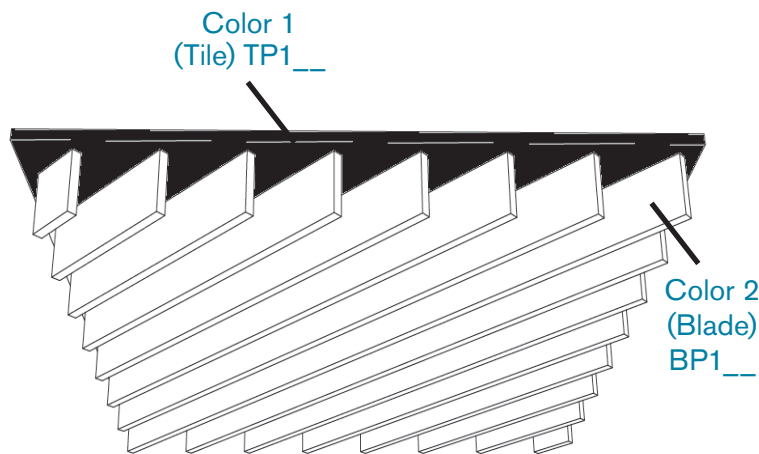

**TWO COLOR
OPTION**



REC - RECTANGLE IN P116 OAT & P121 COCOA

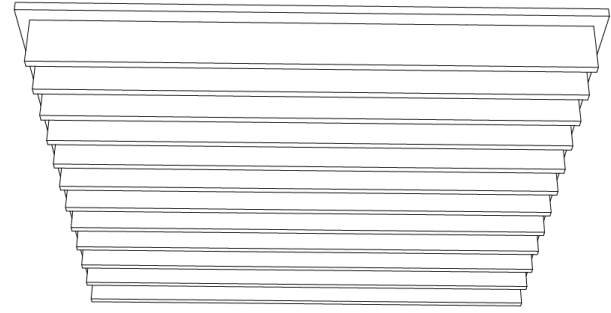

REC - RECTANGLE

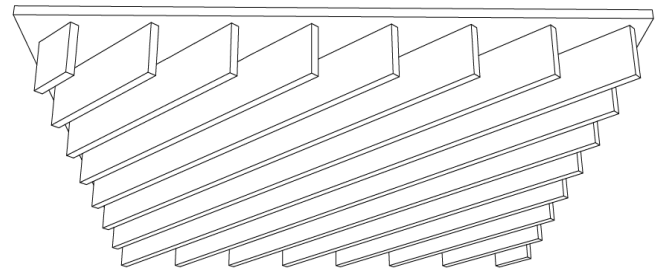
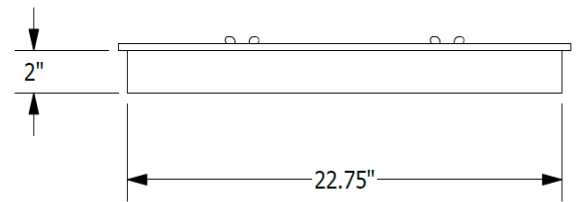

DIA - DIAGONAL

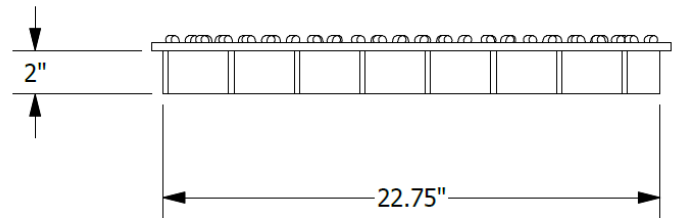

DIA - DIAGONAL IN TILE COLOR 1 TP122 JET & BLADE COLOR 2 BP117 SKY

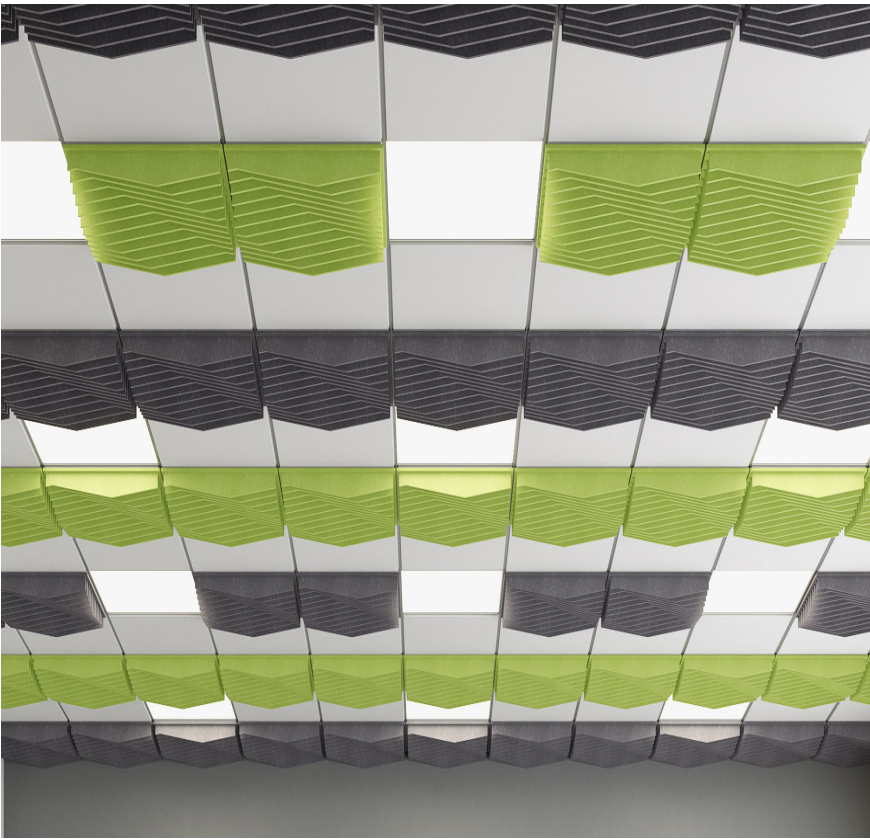

A1P - ANGLE 1 PROGRESSIVE IN P100 ASH & P103 PEAR

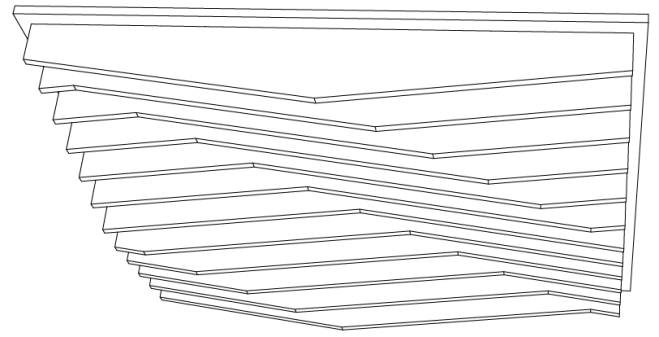

A1P - ANGLE 1 PROGRESSIVE

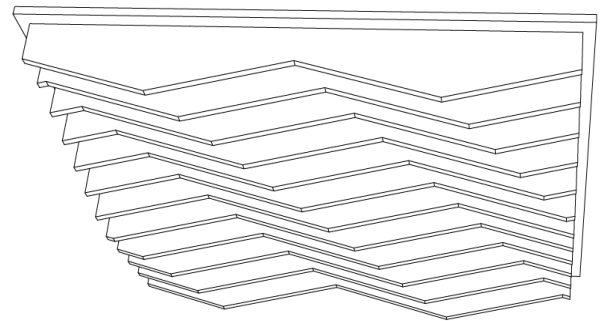
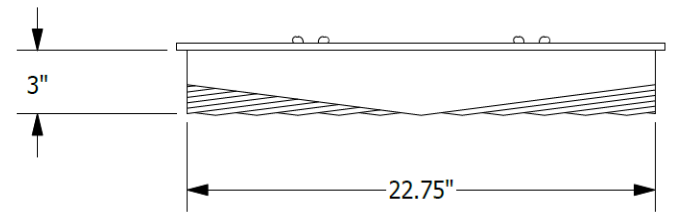

A2P - ANGLE 2 PROGRESSIVE

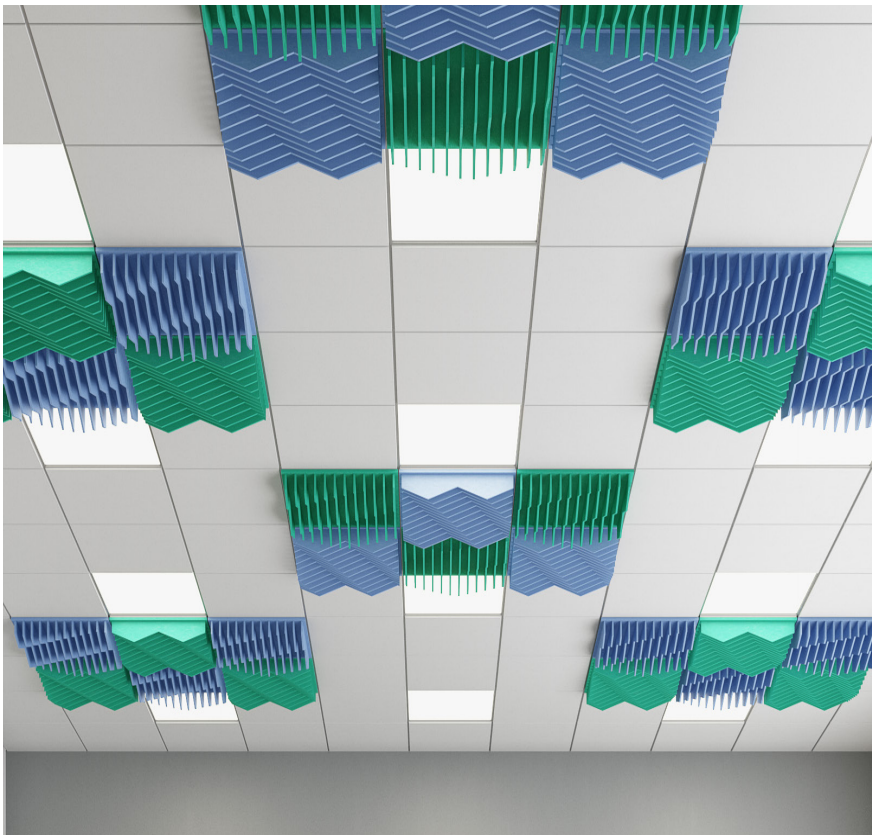
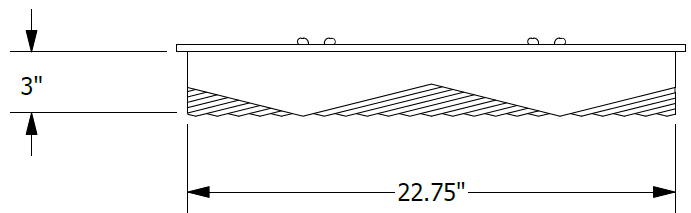

A2P - ANGLE 2 PROGRESSIVE IN P115 AQUA & P117 SKY

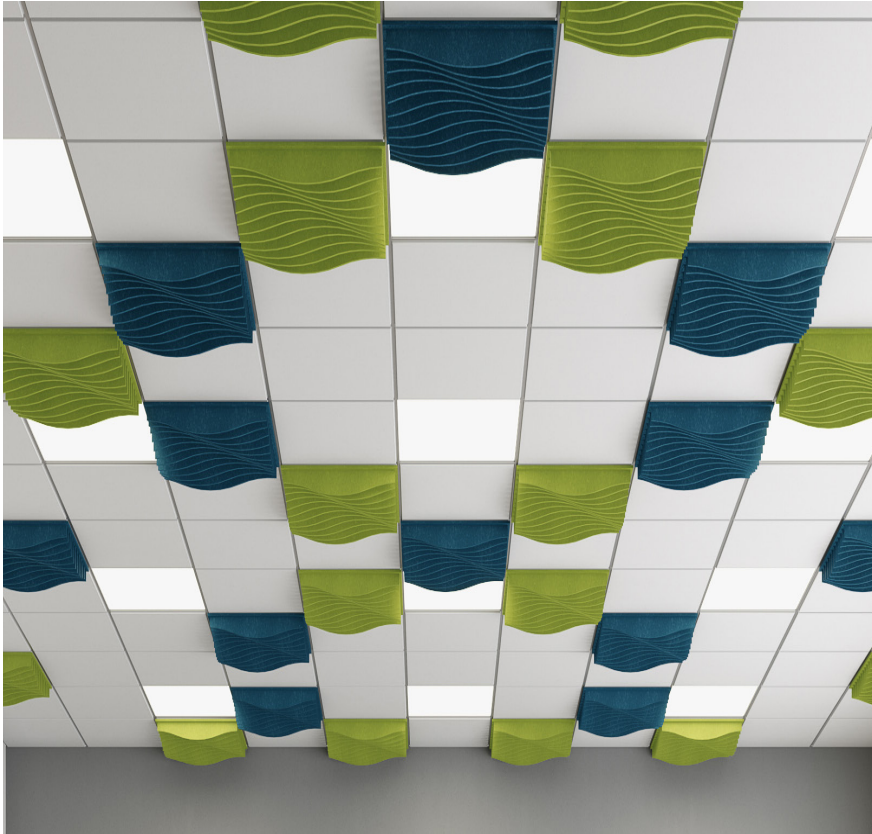

W1P - WAVE 1 PROGRESSIVE IN P118 DENIM & P120 MOSS

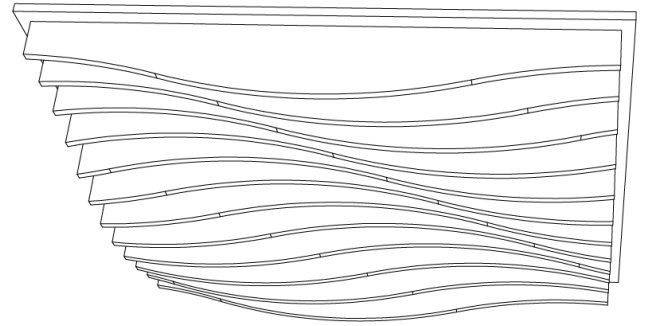

W1P - WAVE 1 PROGRESSIVE

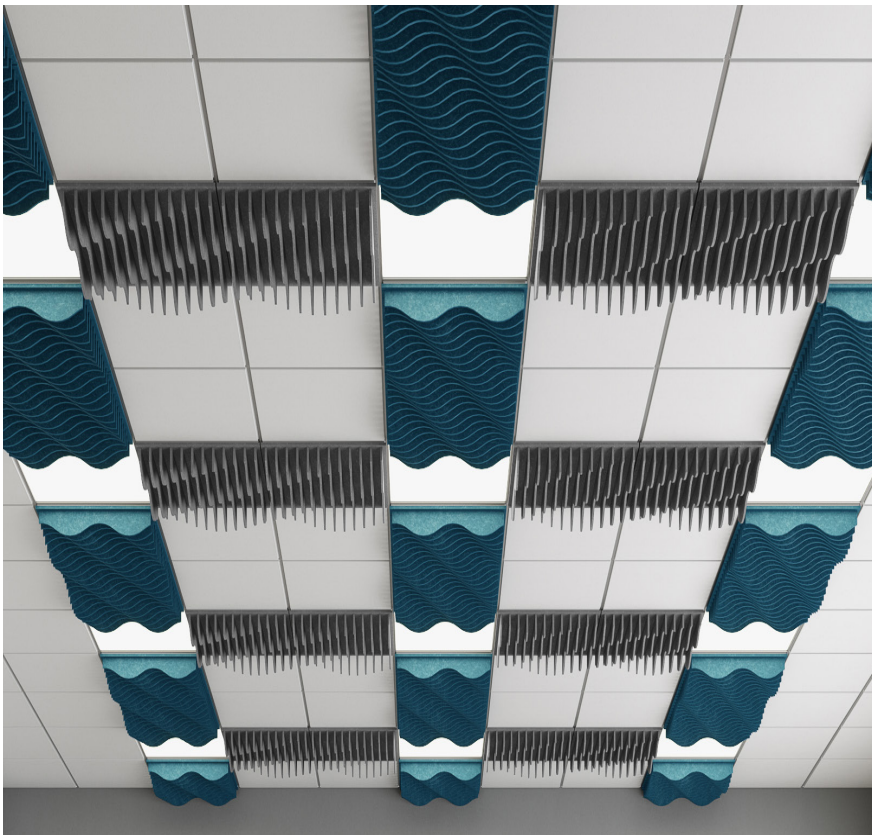
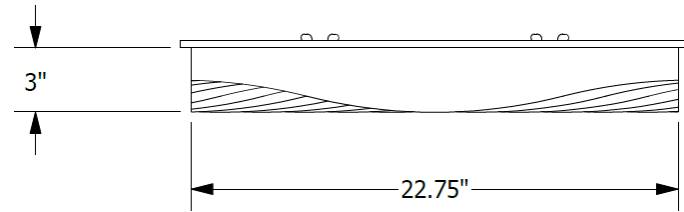

W2P - WAVE 2 PROGRESSIVE IN P100 ASH & P118 DENIM

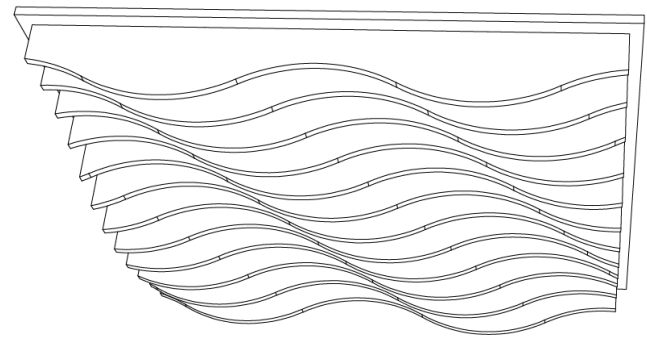

W2P - WAVE 2 PROGRESSIVE

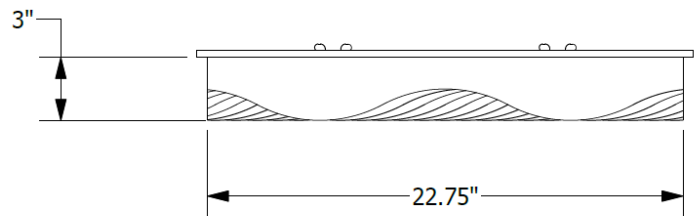

MATERIAL OPTIONS

ECHOSCAPE™ 3/8" (9MM)



Snow
P114



New
Canvas
P126

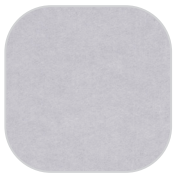

New
Overcast
P124



Oat
P116



Cocoa
P121



Sunflower
P111

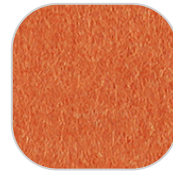

Tangerine
P109



Ruby
P108



Aqua
P115



Pear
P103



Moss
P120



Spruce
P123



Sky
P117

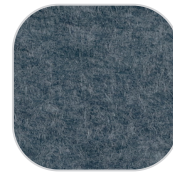

New
Blueprint
P125

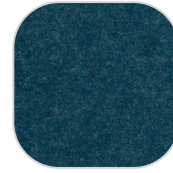

Denim
P118



Cobalt
P102



Midnight
P119



Iced Grey
P106



Ash
P100



Slate
P105



Charcoal
P101



Jet
P122