



SIGNATURE SERIES

2020/2021 Precision Profiles and Transitions





Since
1968

Established in 1968 and headquartered in Los Angeles, California, Emser Tile® is a leading designer, producer and marketer of the world's finest tile and natural stone. By offering unparalleled service and a vast selection of products, Emser Tile is a comprehensive source for interior and exterior products that include porcelain, ceramic, glass, decorative accents, metal, quarry, mosaics, natural and engineered stone, cut-to-size products, setting materials and custom manufactured products made to your specifications. Our nationwide service network includes state of the art distribution centers and local sales and service locations to combine a strong national presence with tailored, local service. Building upon 50 years of service, our dedication and commitment to our customers remains as strong as ever and are the core of our business and our culture.

Our services are tailored to customers' specific requirements. Emser Tile offers exclusive programs that help retailers, home builders, commercial builders, contractors, architects and designers exceed their customers' expectations and requirements while keeping projects on schedule and within budget.

Our global network brings the latest trends, technologies and innovations for ceramic and porcelain tile, glass, natural stone, decorative, mosaic and metal products. We continue to offer the most compelling and extensive portfolio of colors, finishes, patterns and textures, accompanied by a broad assortment of coordinating trim and accent pieces.

Our expansive capacity translates into vast selection of products and immediate distribution. With Emser Tile, customers have quick access to unique and first-to-market products. With our local sales and service locations and global network of factory alliances, Emser Tile has the infrastructure to logistically support any size project on a domestic or international level.



CUBELINE 23



42 ANTI-SKID STEP STRIP

EMSER SIGNATURE SERIES

8

TRIMS FOR WALL, FLOOR AND COUNTERTOP APPLICATIONS

EDGE PROTECTOR TRIM	12
QUARTER CIRCLE TILE TRIM	16
FLOOR ACCENT PROFILE	22
CUBELINE	23
DECOLINE	28
CORNER PRO	28
CORNER ANGLE	29
CORNER ANGLE PLUS	29
SILL PROFILE	30
F-PROFILE	30
NEW NEW YORK EDITION	32
NEW LUXURY LINE	38

STAIR PROFILES

ANTI-SKID STEP STRIP	42
HD ANTI-SKID STEP STRIP	43
CLASSIC STAIR NOSE	44
DECO STAIR NOSE PROFILE	45
STEPLINE	47

TRANSITION AND RENOVATION PROFILES

ADJUSTABLE TRANSITION PROFILE	50
SELF-ADHESIVE TRANSITION PROFILE	50
TTRANSITION PROFILE <i>Gap-Covering</i>	51
DRIVE	51
REDUCER TRIM	52
CARPET TRIM	52
SKIRTING	53
NEW COVE	54

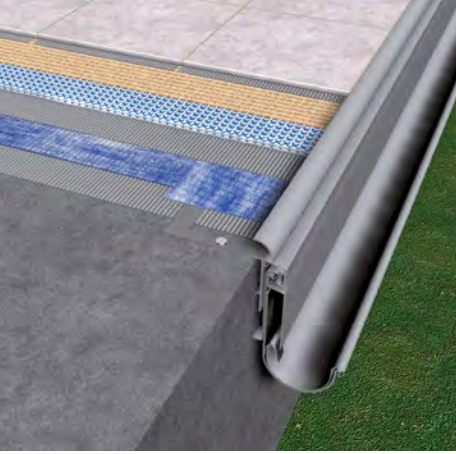

ULTRA-DRAIN 74



NEW COVE 54



68 AQUA-DECO

EXPANSION JOINTS AND SCREED ACCESSORIES

FLOOREX	58
HEAVY DUTY EXPANSION JOINT	59
SCREED EXPANSION JOINT	60
V-SCREED EXPANSION JOINT	60

AQUA PROFILES

AQUA-KEIL	64
AQUA-KEIL WALL	66
AQUA-DECO	68
AQUA GLASS	68
AQUA-KEIL GLASS	70

WATERPROOFING SYSTEMS

ULTRA-DRAIN	74
-------------	----

BALCONY AND TERRACE SYSTEMS

DE PROFILE	78
BALCONY-Gutter Quarter Circle Trim	79
BALCONY-Gutter Edge Protector	80
BALCONY-EDGE PROTECTOR PRO	82
BALCONY-EDGE PROTECTOR	84
BALCONY-EDGE PROTECTOR PLUS	85
BALCONY-GRAVEL DECK EDGE PRO	86
GRAVEL DECK EDGE	87
COVECOVER	88

Material surfaces	90
Common color/finish codes	94
Height conversion chart	94
Part number identification system	95
Freight and shipping charges	95





SHOWER + WALL
Marble | Bianco Gioia

FLOOR
Style II | Pure White

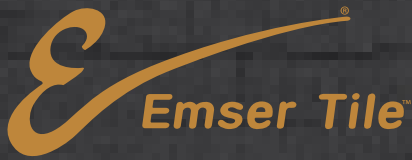

SIGNATURE SERIES

PREMIUM PROFILES AND TRANSITIONS





The Emser Tile® *Signature Series* is an expertly-curated collection of trims that contains bestselling tile transitions and profiles designed to meet and exceed the needs of the modern tile installer. During the careful selection of the shapes and finishes for the Emser Tile *Signature Series*, a tremendous emphasis was placed on satisfying commercial and residential market demands so that the perfect tile trim for every tile job would be easily within reach.

The Emser Tile *Signature Series* tile transitions and profiles are stocked at Emser locations nationwide. Additional styles, sizes, and finishes are readily available via special order.



SIGNATURE SERIES STOCKED ITEMS

EDGE PROTECTOR TRIM

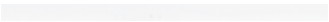
								
STAINLESS STEEL 8.0			ALUMINUM 8.0			ALUMINUM 8.0		
NATURAL			NATURAL			SATIN SILVER, ANODIZED		
Length: 8.0 feet			Length: 8.0 feet			Length: 8.0 feet		
Pack: 10 pcs.			Pack: 10 pcs.			Pack: 10 pcs.		
h/in.	Part no.	\$/pc.	h/in.	Part no.	\$/pc.	h/in.	Part no.	\$/pc.
3/8	ZBL300-280-10025-1	31.04	5/16	ZBL300-400-08025-1	8.57	5/16	ZBL300-410-08025-1	12.90
			3/8	ZBL300-400-10025-1	9.12	3/8	ZBL300-410-10025-1	13.80
			1/2	ZBL300-400-12525-1	9.57	1/2	ZBL300-410-12525-1	14.69
								
ALUMINUM 8.0			ALUMINUM 8.0			ALUMINUM 8.0		
SHINY SILVER, ANODIZED			TITANIUM BRONZE, ANODIZED			WHITE, POWDER-COATED		
Length: 8.0 feet			Length: 8.0 feet			Length: 8.0 feet		
Pack: 10 pcs.			Pack: 10 pcs.			Pack: 10 pcs.		
h/in.	Part no.	\$/pc.	h/in.	Part no.	\$/pc.	h/in.	Part no.	\$/pc.
5/16	ZBL300-430-08025	14.47	5/16	ZBL300-446-08025	16.03	5/16	300-450-08025-1	14.69
3/8	ZBL300-430-10025-1	16.69	3/8	ZBL300-446-10025-1	16.24	3/8	300-450-10025	16.03
1/2	ZBL300-430-12525	17.80	1/2	ZBL300-446-12525-1	16.86			



SIGNATURE SERIES STOCKED ITEMS

EDGE PROTECTOR TRIM

ALUMINUM 8.0		
OIL RUBBED BRONZE, ANODIZED		
Length: 8.0 feet		Pack: 10 pcs.
h/in.	Part no.	\$/pc.
3/8	ZBL300-449-10025	20.51

ALUMINUM 8.0		
MATT BLACK, ANODIZED		
Length: 8.0 feet		Pack: 10 pcs.
h/in.	Part no.	\$/pc.
3/8	ZBL300-416-10025	16.55

ALUMINUM 8.0		
SATIN GOLD, ANODIZED		
Length: 8.0 feet		Pack: 10 pcs.
h/in.	Part no.	\$/pc.
3/8	ZBL300-420-10025-1	14.24



Additional sizes and finishes of EDGE PROTECTOR TRIMS are available on page 12.

PVC 8.0		
WHITE		
Length: 8.0 feet		Pack: 10 pcs.
h/in.	Part no.	\$/pc.
3/8	ZBL300-501-1025	5.56

QUARTER CIRCLE TRIM

ALUMINUM 8.0		
SATIN SILVER, ANODIZED		
Length: 8.0 feet		Pack: 5 pcs.
h/in.	Part no.	\$/pc.
3/8	ZBL347-410-10025	19.02
1/2	ZBL347-410-12525-1	22.70

ALUMINUM 8.0		
TITANIUM BRONZE, ANODIZED		
Length: 8.0 feet		Pack: 5 pcs.
h/in.	Part no.	\$/pc.
3/8	ZBL347-446-10025	21.91
1/2	ZBL347-446-12525	24.82



Additional sizes and finishes of QUARTER CIRCLE TRIMS are available on page 16.

CUBELINE TRIM

ALUMINUM 8.0		
SATIN SILVER, ANODIZED		
Length: 8.0 feet		Pack: 5 pcs.
h/in.	Part no.	\$/pc.
3/8	ZBL740-410-11025	19.03



Additional sizes and finishes of CUBELINE TRIMS are available on page 23.

REDUCER TRIM

ALUMINUM 8.0		
SATIN SILVER, ANODIZED		
Length: 8.0 feet		Pack: 5 pcs.
h/in.	Part no.	\$/pc.
3/8	ZBL217-410-10025	16.91

CARPET TRIM

ALUMINUM 8.0		
SATIN SILVER, ANODIZED		
Length: 8.0 feet		Pack: 5 pcs.
h/in.	Part no.	\$/pc.
3/8	ZBL218-410-10025-1	16.24



Additional sizes and finishes of REDUCER TRIMS are available on page 54.



Additional sizes and finishes of CARPET TRIMS are available on page 54.



TRIMS

WALL, FLOOR
& COUNTERTOP
APPLICATIONS

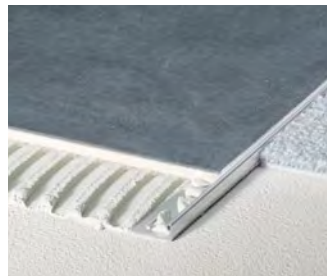

12 EDGE
PROTECTOR TRIM



23 CUBELINE



EDGE PROTECTOR TRIM

EDGE PROTECTOR TRIMS are designed to provide decorative protection for tile edges. Use EDGE PROTECTOR TRIMS where the tile edges are exposed to impact and where an attractive, professional finish is desired. Part numbers in **bold** indicate stocked Emser **Signature Series** item.

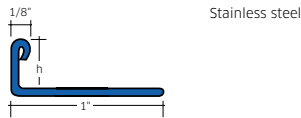
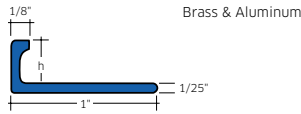

BRASS NATURAL 8.0

Length: 8.0 feet Pack: 10 pcs.

h/in.	Part no.	\$/pc.
1/8	ZBL300-300-03025	22.48
3/16	ZBL300-300-04525	25.14
1/4	ZBL300-300-06025-1	26.25
5/16	ZBL300-300-08025	28.93
3/8	ZBL300-300-10025	29.48
1/2	ZBL300-300-12525	30.61
13/32	ZBL300-300-15025	34.39
3/4	ZBL300-300-18525	35.94
7/8	ZBL300-300-22025	44.17
1	ZBL300-300-25025	45.62
1 1/16	ZBL300-300-30025	48.73

BRASS CHROME-PLATED 8.0

Length: 8.0 feet Pack: 1 pc.

h/in.	Part no.	\$/pc.
1/4	ZBL300-340-06025	68.99
3/16	ZBL300-340-08025	71.77
3/8	ZBL300-340-10025	72.33
7/16	ZBL300-340-11025	72.88
1/2	ZBL300-340-12525-1	73.44

STAINLESS STEEL NATURAL 8.0

Length: 8.0 feet Pack: 10 pcs.

h/in.	Part no.	\$/pc.
1/8	ZBL300-280-02025	22.25
3/16	ZBL300-280-03025	23.37
1/4	ZBL300-280-04525-1	27.82
5/16	ZBL300-280-06025-1	28.37
3/8	ZBL300-280-07025	29.30
1/2	ZBL300-280-08025-1	29.39
13/32	ZBL300-280-09025	30.71
3/8	ZBL300-280-10025-1	31.04
7/16	ZBL300-280-11025	31.55
1/2	ZBL300-280-12525-1	32.04
13/32	ZBL300-280-14025	37.06
19/32	ZBL300-280-15025	37.51
3/8	ZBL300-280-16025	38.00
3/4	ZBL300-280-18525	40.06
13/16	ZBL300-280-20025	41.59
7/8	ZBL300-280-22025-1	41.72
1	ZBL300-280-25025	42.98
1 1/16	ZBL300-280-30025	51.58

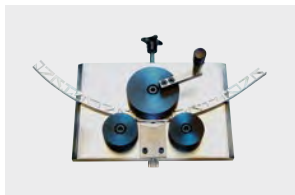

Expert tip:

The DA BENDER, a tool used at the jobsite to bend the BEND-EASE profiles, is featured on page 100. Brass, aluminum and stainless steel edge protectors are available in 8' length with an extra cut in the setting leg to facilitate bending. To order, add a »S« to the end of Part Number. (ex. ZBL300-300-10025S = 3/8" Edge Protector Brass Bendease). Profiles can take 1-2 weeks for delivery. The price for the »Bend-Ease« profiles is the standard price per piece plus \$ 6.48.

STAINLESS STEEL POLISHED 8.0

Length: 8.0 feet Pack: 10 pcs.

h/in.	Part no.	\$/pc.
1/8	ZBL300-286-03025	52.85
3/16	ZBL300-286-04525	57.30
1/4	ZBL300-286-06025	58.32
5/16	ZBL300-286-08025	59.75
3/8	ZBL300-286-10025-1	61.30
7/16	ZBL300-286-11025	62.83
1/2	ZBL300-286-12525	63.10
19/32	ZBL300-286-15025	67.32
3/4	ZBL300-286-18525	70.10
7/8	ZBL300-286-22025	72.33

STAINLESS STEEL BRUSHED 8.0

Length: 8.0 feet Pack: 10 pcs.

h/in.	Part no.	\$/pc.
1/4	ZBL300-280-06025B	34.04
3/16	ZBL300-280-07025B	35.08
1/8	ZBL300-280-08025B	35.33
13/32	ZBL300-280-09025B	37.42
3/8	ZBL300-280-10025B	38.28
7/16	ZBL300-280-11025B	38.50
1/2	ZBL300-280-12525B	39.24
17/32	ZBL300-280-14025B	39.45
19/32	ZBL300-280-15025B	39.77
3/8	ZBL300-280-16025B	40.49
3/4	ZBL300-280-18525B	41.74
19/16	ZBL300-280-20025B	42.89
7/8	ZBL300-280-22025B	43.38

STAINLESS STEEL ACID-RESISTANT (AISI 316) 8.0

Length: 8.0 feet Pack: 10 pcs.

h/in.	Part no.	\$/pc.
1/4	ZBL300-285-06025	43.85
3/16	ZBL300-285-08025	45.40
3/8	ZBL300-285-10025-1	47.19
1/2	ZBL300-285-12525	49.06
19/32	ZBL300-285-15025	51.03



ALUMINUM 8.0
NATURAL

Length: 8.0 feet Pack: 10 pcs.

h/in.	Part no.	\$/pc.
1/16	ZBL300-400-02025	6.91
1/8	ZBL300-400-03025	7.12
3/16	ZBL300-400-04525	7.57
1/4	ZBL300-400-06025-1	8.01
5/16	ZBL300-400-08025-1	8.57
3/8	ZBL300-400-10025-1	9.12
7/16	ZBL300-400-11025	9.30
1/2	ZBL300-400-12525-1	9.57
13/32	ZBL300-400-15025-1	10.01
3/4	ZBL300-400-18525-1	10.57
15/16	ZBL300-400-20025	11.45
1	ZBL300-400-22025	11.91
1	ZBL300-400-25025	12.90
1 1/16	ZBL300-400-30025	13.80

ALUMINUM 8.0
SATIN SILVER, BRUSHED ANODIZED

Length: 8.0 feet Pack: 10 pcs.

h/in.	Part no.	\$/pc.
1/16	ZBL300-410B-08025	30.19
3/16	ZBL300-410B-10025	30.61
7/16	ZBL300-410B-11025	31.06
1/2	ZBL300-410B-12525	31.69

ALUMINUM 8.0
SATIN SILVER, ANODIZED

Length: 8.0 feet Pack: 10 pcs.

h/in.	Part no.	\$/pc.
1/16	ZBL300-410-02025	10.81
1/8	ZBL300-410-03025	11.13
3/16	ZBL300-410-04525	11.36
1/4	ZBL300-410-06025	12.14
5/16	ZBL300-410-08025-1	12.90
3/8	ZBL300-410-10025-1	13.80
7/16	ZBL300-410-11025	14.24
1/2	ZBL300-410-12525-1	14.69
13/32	ZBL300-410-15025-1	15.24
3/4	ZBL300-410-18525-1	16.24
15/16	ZBL300-410-20025	17.18
1	ZBL300-410-22025	18.36
1	ZBL300-410-25025	19.36
1 1/16	ZBL300-410-30025	21.48

ALUMINUM 8.0
SHINY SILVER, ANODIZED

Length: 8.0 feet Pack: 10 pcs.

h/in.	Part no.	\$/pc.
1/4	ZBL300-430-06025-1	13.36
5/16	ZBL300-430-08025	14.47
3/8	ZBL300-430-10025-1	16.69
7/16	ZBL300-430-11025	17.08
1/2	ZBL300-430-12525	17.80
13/32	ZBL300-430-15025	18.22
3/4	ZBL300-430-18525	18.95

ALUMINUM 8.0
SATIN GOLD, ANODIZED

Length: 8.0 feet Pack: 10 pcs.

h/in.	Part no.	\$/pc.
3/16	ZBL300-420-04525	11.36
1/4	ZBL300-420-06025	12.14
5/16	ZBL300-420-08025	12.70
3/8	ZBL300-420-10025-1	14.24
1/2	ZBL300-420-12525	15.35
13/32	ZBL300-420-15025	16.03

ALUMINUM 8.0
SHINY GOLD, ANODIZED

Length: 8.0 feet Pack: 10 pcs.

h/in.	Part no.	\$/pc.
1/4	ZBL300-480-06025	13.13
5/16	ZBL300-480-08025	13.36
3/8	ZBL300-480-10025-1	15.03
1/2	ZBL300-480-12525	16.14

ALUMINUM 8.0
MATT BLACK, ANODIZED

Length: 8.0 feet Pack: 10 pcs.

h/in.	Part no.	\$/pc.
1/4	ZBL300-416-06025	15.76
5/16	ZBL300-416-08025	15.83
3/8	ZBL300-416-10025	16.55
7/16	ZBL300-416-11025	17.18
1/2	ZBL300-416-12525	17.49
13/32	ZBL300-416-15025	20.36
3/4	ZBL300-416-18525	21.92

ALUMINUM 8.0
BLACK, POWDER-COATED

Length: 8.0 feet Pack: 10 pcs.

h/in.	Part no.	\$/pc.
1/4	ZBL300-456-06025	13.91
5/16	ZBL300-456-08025	14.69
3/8	ZBL300-456-10025-1	16.03
1/2	ZBL300-456-12525-1	17.80
13/32	ZBL300-456-15025	18.80
3/4	ZBL300-456-18525	19.85

ALUMINUM 8.0
ROYAL CHAMPAGNE, ANODIZED

Length: 8.0 feet Pack: 10 pcs.

h/in.	Part no.	\$/pc.
5/16	ZBL300-470-08025	15.13
3/8	ZBL300-470-10025	15.66
7/16	ZBL300-470-11025	15.84
1/2	ZBL300-470-12525	16.52

ALUMINUM 8.0
TITANIUM BRONZE, ANODIZED

Length: 8.0 feet Pack: 10 pcs.

h/in.	Part no.	\$/pc.
1/4	ZBL300-446-06025	15.91
5/16	ZBL300-446-08025	16.03
3/8	ZBL300-446-10025-1	16.24
1/2	ZBL300-446-12525-1	16.86
13/32	ZBL300-446-15025	17.05
3/4	ZBL300-446-18525	17.55

ALUMINUM 8.0
WHITE, POWDER-COATED

Length: 8.0 feet Pack: 10 pcs.

h/in.	Part no.	\$/pc.
3/16	ZBL300-450-04525	13.69
1/4	ZBL300-450-06025	13.91
5/16	ZBL300-450-08025-1	14.69
3/8	ZBL300-450-10025	16.03
7/16	ZBL300-450-11025	16.92
1/2	ZBL300-450-12525-1	17.80
13/32	ZBL300-450-15025	19.48
3/4	ZBL300-450-18525	20.66

ALUMINUM 8.0
OIL RUBBED BRONZE, ANODIZED

Length: 8.0 feet Pack: 10 pcs.

h/in.	Part no.	\$/pc.
1/4	ZBL300-449-06025	19.81
5/16	ZBL300-449-08025	19.99
3/8	ZBL300-449-10025	20.51
7/16	ZBL300-449-11025	21.13
1/2	ZBL300-449-12525-1	21.65
13/32	ZBL300-449-15025	22.15
3/4	ZBL300-449-18525	22.88

ALUMINUM 8.0		
BRUSHED NICKEL, ANODIZED		
Length: 8.0 feet		Pack: 10 pcs.
h/in.	Part no.	\$/pc.
¼	ZBL300-420B-06025	18.51
⅙	ZBL300-420B-08025	18.74
⅜	ZBL300-420B-10025	18.90
⅚	ZBL300-420B-11025	18.95
½	ZBL300-420B-12525	19.57
⅞	ZBL300-420B-15025	19.95
¾	ZBL300-420B-18525	20.65

ALUMINUM 8.0		
MATTE BLACK, BRUSHED ANODIZED		
Length: 8.0 feet		Pack: 10 pcs.
h/in.	Part no.	\$/pc.
⅙	ZBL300-416B-08025	39.18
⅜	ZBL300-416B-10025	39.60
⅚	ZBL300-416B-11025	40.22
½	ZBL300-416B-12525	40.72

ALUMINUM 8.0		
SATIN GOLD, BRUSHED ANODIZED		
Length: 8.0 feet		Pack: 10 pcs.
h/in.	Part no.	\$/pc.
⅙	ZBL300-42GB-08025	31.40
⅜	ZBL300-42GB-10025	31.81
⅚	ZBL300-42GB-11025	32.27
½	ZBL300-42GB-12525	32.94

ALUMINUM 8.0		
TITANIUM BRONZE, BRUSHED ANODIZED		
Length: 8.0 feet		Pack: 10 pcs.
h/in.	Part no.	\$/pc.
⅙	ZBL300-446B-08025	39.18
⅜	ZBL300-446B-10025	39.60
⅚	ZBL300-446B-11025	40.22
½	ZBL300-446B-12525	40.72

ALUMINUM 8.0		
ROYAL CHAMPAGNE, BRUSHED ANODIZED		
Length: 8.0 feet		Pack: 10 pcs.
h/in.	Part no.	\$/pc.
⅙	ZBL300-470B-08025	31.40
⅜	ZBL300-470B-10025	31.81
⅚	ZBL300-470B-11025	32.27
½	ZBL300-470B-12525	32.94

ALUMINUM 8.0		
SAND TROPEZ, TEXTURED POWDER-COATED		
Length: 8.0 feet		Pack: 10 pcs.
h/in.	Part no.	\$/pc.
⅙	ZBL300-4571A-08025	34.39
⅜	ZBL300-4571A-10025	34.85
⅚	ZBL300-4571A-11025	35.02
½	ZBL300-4571A-12525	36.81

ALUMINUM 8.0		
STONE GRAY, TEXTURED POWDER-COATED		
Length: 8.0 feet		Pack: 10 pcs.
h/in.	Part no.	\$/pc.
⅙	ZBL300-4591A-08025	34.39
⅜	ZBL300-4591A-10025	34.85
⅚	ZBL300-4591A-11025	35.02
½	ZBL300-4591A-12525	36.81

ALUMINUM 8.0		
GRAPHITE, TEXTURED POWDER-COATED		
Length: 8.0 feet		Pack: 10 pcs.
h/in.	Part no.	\$/pc.
⅙	ZBL300-4561A-08025	34.39
⅜	ZBL300-4561A-10025	34.85
⅚	ZBL300-4561A-11025	35.02
½	ZBL300-4561A-12525	36.81

ALUMINUM 8.0		
OXIDE, TEXTURED POWDER-COATED		
Length: 8.0 feet		Pack: 10 pcs.
h/in.	Part no.	\$/pc.
⅙	ZBL300-4581A-08025	34.39
⅜	ZBL300-4581A-10025	34.85
⅚	ZBL300-4581A-11025	35.02
½	ZBL300-4581A-12525	36.81

NEW ALUMINUM 8.0		
SUGAR WHITE, TEXTURED POWDER-COATED		
Length: 8.0 feet		Pack: 5 pcs.
h/in.	Part no.	\$/pc.
⅙	ZBL300-4512A-08025	34.39
⅜	ZBL300-4512A-10025	34.85
½	ZBL300-4512A-12525	36.81

NEW ALUMINUM 8.0		
QUARTZ, TEXTURED POWDER-COATED		
Length: 8.0 feet		Pack: 5 pcs.
h/in.	Part no.	\$/pc.
⅙	ZBL300-4521A-08025	34.39
⅜	ZBL300-4521A-10025	34.85
½	ZBL300-4521A-12525	36.81

NEW ALUMINUM 8.0		
OYSTER WHITE, TEXTURED POWDER-COATED		
Length: 8.0 feet		Pack: 5 pcs.
h/in.	Part no.	\$/pc.
⅙	ZBL300-4511A-08025	34.39
⅜	ZBL300-4511A-10025	34.85
½	ZBL300-4511A-12525	36.81

NEW ALUMINUM 8.0		
INDUSTRIAL RUST, TEXTURED POWDER-COATED		
Length: 8.0 feet		Pack: 5 pcs.
h/in.	Part no.	\$/pc.
⅙	ZBL300-4583A-08025	34.39
⅜	ZBL300-4583A-10025	34.85
½	ZBL300-4583A-12525	36.81

NEW ALUMINUM 8.0		
COAL BLACK, TEXTURED POWDER-COATED		
Length: 8.0 feet		Pack: 5 pcs.
h/in.	Part no.	\$/pc.
⅙	ZBL300-4562A-08025	34.39
⅜	ZBL300-4562A-10025	34.85
½	ZBL300-4562A-12525	36.81

NEW ALUMINUM 8.0		
DARK CHOCOLATE, TEXTURED POWDER-COATED		
Length: 8.0 feet		Pack: 5 pcs.
h/in.	Part no.	\$/pc.
⅙	ZBL300-4582A-08025	34.39
⅜	ZBL300-4582A-10025	34.85
½	ZBL300-4582A-12525	36.81

EDGE PROTECTOR TRIM

EDGE PROTECTOR TRIMS (PVC) are designed to provide a decorative finish and protection to the outside corners of tiled surfaces. The PVC EDGE PROTECTOR TRIMS maintain excellent surface quality and are durable against most solvents, weather, and UV rays. Part numbers in **bold** indicate stocked Emser *Signature Series* items.



PVC **8.0**
WHITE

Length: 8.0 feet Pack: 10 pcs.

h/in.	Part no.	\$/pc.
¼	ZBL300-501-6025	5.24
⅜	ZBL300-501-8025	5.47
½	ZBL300-501-1025	5.56
⅞	ZBL300-501-11025	5.62
1	ZBL300-501-12525-1	5.89

PVC **8.0**
JASMINE

Length: 8.0 feet Pack: 10 pcs.

h/in.	Part no.	\$/pc.
¼	ZBL300-5011-6025	5.24
⅜	ZBL300-5011-8025-1	5.47
½	ZBL300-5011-1025	5.56
⅞	ZBL300-5011-11025	5.62
1	ZBL300-5011-12525-1	5.89

PVC **8.0**
SILVER GRAY

Length: 8.0 feet Pack: 10 pcs.

h/in.	Part no.	\$/pc.
¼	ZBL300-5092-6025	5.24
⅜	ZBL300-5092-8025-1	5.47
½	ZBL300-5092-1025	5.56
⅞	ZBL300-5092-11025	5.62
1	ZBL300-5092-12525	5.89

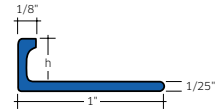

PVC

PVC **8.0**
MANHATTAN GRAY

Length: 8.0 feet Pack: 10 pcs.

h/in.	Part no.	\$/pc.
¼	ZBL300-5091-6025	5.24
⅜	ZBL300-5091-8025-1	5.47
½	ZBL300-5091-1025-1	5.56
⅞	ZBL300-5091-11025	5.62
1	ZBL300-5091-12525-1	5.89



Style II™ | Pure White



QUARTER CIRCLE TILE TRIM

QUARTER CIRCLE TILE TRIMS provide a decorative finish and edge protection for wall and countertop tiled edges. The brass and stainless steel QUARTER CIRCLE form a symmetrical, curved edge and can also be used as stair nose and transition trims.

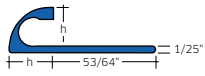

Brass

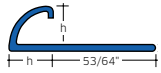

Stainless steel

QUARTER CIRCLE TILE TRIM

BRASS NATURAL 8.0

Length: 8.0 feet Pack: 5 pcs.

h/in.	Part no.	\$/pc.
¼	ZBL347-300-06025	50.29
⅜	ZBL347-300-08025	59.63
½	ZBL347-300-10025	70.10
⅝	ZBL347-300-12525	86.46
⅞	ZBL347-300-15025	106.37

QUARTER CIRCLE TILE TRIM, OUTER CORNERS

QUARTER CIRCLE TILE TRIM, INNER CORNERS

Expert tip:

When ordering the QUARTER CIRCLE TILE TRIM please do not forget the inner and outer corners!



BRASS CHROME-PLATED 8.0

Length: 8.0 feet Pack: 1 pc.

h/in.	Part no.	\$/pc.
¼	ZBL347-340-06025	83.00
⅜	ZBL347-340-08025	92.36
½	ZBL347-340-10025	102.82
⅝	ZBL347-340-12525	121.51
⅞	ZBL347-340-15025	141.42

BRASS LOOK CHROME-PLATED

Pack: 1 pc.

h/in.	Part no.	\$/pc.
¼	ZBL348-940-060	6.15
⅜	ZBL348-940-080	6.15
½	ZBL348-940-100	6.15
⅝	ZBL348-940-125	6.15

BRASS LOOK CHROME-PLATED

Pack: 1 pc.

h/in.	Part no.	\$/pc.
¼	ZBL349-940-060	6.15
⅜	ZBL349-940-080	6.15
½	ZBL349-940-100	6.15
⅝	ZBL349-940-125	6.15

STAINLESS STEEL NATURAL 8.0

Length: 8.0 feet Pack: 5 pcs.

h/in.	Part no.	\$/pc.
¼	ZBL347-280-06025	40.94
⅜	ZBL347-280-08025	46.40
½	ZBL347-280-10025	49.84
⅝	ZBL347-280-11025	50.77
⅞	ZBL347-280-12525	51.40
1	ZBL347-280-15025	64.30

STAINLESS STEEL NATURAL

Pack: 1 pc.

h/in.	Part no.	\$/pc.
¼	ZBL348-280-060	9.42
⅜	ZBL348-280-080	9.82
½	ZBL348-280-100	11.32
⅝	ZBL348-280-110	14.19
⅞	ZBL348-280-125	15.12
1	ZBL348-280-150	18.56

STAINLESS STEEL NATURAL

Pack: 1 pc.

h/in.	Part no.	\$/pc.
¼	ZBL349-280-060	10.10
⅜	ZBL349-280-080	10.10
½	ZBL349-280-100	10.10
⅝	ZBL349-280-110	10.10
⅞	ZBL349-280-125	10.10

STAINLESS STEEL LOOK NATURAL

Pack: 1 pc.

h/in.	Part no.	\$/pc.
¼	ZBL348-9280-060	6.15
⅜	ZBL348-9280-080	6.15
½	ZBL348-9280-100	6.15
⅝	ZBL348-9280-110	6.15
⅞	ZBL348-9280-125	6.15

STAINLESS STEEL LOOK NATURAL

Pack: 1 pc.

h/in.	Part no.	\$/pc.
¼	ZBL349-9280-060	6.15
⅜	ZBL349-9280-080	6.15
½	ZBL349-9280-100	6.15
⅝	ZBL349-9280-110	6.15
⅞	ZBL349-9280-125	6.15

QUARTER CIRCLE TILE TRIM

STAINLESS STEEL 8.0
BRUSHED

Length: 8.0 feet Pack: 5 pcs.

h/in.	Part no.	\$/pc.
¼	ZBL347-280-06025B	51.39
⅜	ZBL347-280-08025B	58.40
½	ZBL347-280-10025B-1	64.17
⅝	ZBL347-280-11025B	64.44
¾	ZBL347-280-12525B	64.80

QUARTER CIRCLE TILE
TRIM, OUTER CORNERSSTAINLESS STEEL
BRUSHED

Pack: 1 pc.

h/in.	Part no.	\$/pc.
¼	ZBL348-280B-060	12.08
⅜	ZBL348-280B-080	12.86
½	ZBL348-280B-100	13.59
⅝	ZBL348-280B-110	16.23
¾	ZBL348-280B-125	18.88

QUARTER CIRCLE TILE
TRIM, INNER CORNERSSTAINLESS STEEL
BRUSHED

Pack: 1 pc.

h/in.	Part no.	\$/pc.
¼	ZBL349-280B-060	11.10
⅜	ZBL349-280B-080	11.10
½	ZBL349-280B-100	11.10
⅝	ZBL349-280B-110	11.10
¾	ZBL349-280B-125	11.10

STAINLESS STEEL LOOK
BRUSHED

Pack: 1 pc.

h/in.	Part no.	\$/pc.
¼	ZBL348-928B-060	6.15
⅜	ZBL348-928B-080	6.15
½	ZBL348-928B-100	6.15
⅝	ZBL348-928B-110	6.15
¾	ZBL348-928B-125	6.15

STAINLESS STEEL LOOK
BRUSHED

Pack: 1 pc.

h/in.	Part no.	\$/pc.
¼	ZBL349-928B-060	6.15
⅜	ZBL349-928B-080	6.15
½	ZBL349-928B-100	6.15
⅝	ZBL349-928B-110	6.15
¾	ZBL349-928B-125	6.15

STAINLESS STEEL 8.0
POLISHED

Length: 8.0 feet Pack: 5 pcs.

h/in.	Part no.	\$/pc.
¼	ZBL347-286-06025	59.43
⅜	ZBL347-286-08025	65.20
½	ZBL347-286-10025	71.11
⅝	ZBL347-286-11025	73.46
¾	ZBL347-286-12525	76.89

STAINLESS STEEL
POLISHED

Pack: 1 pc.

h/in.	Part no.	\$/pc.
¼	ZBL348-286-060	12.08
⅜	ZBL348-286-080	12.86
½	ZBL348-286-100	13.59
⅝	ZBL348-286-110	16.23
¾	ZBL348-286-125	18.88

STAINLESS STEEL
POLISHED

Pack: 1 pc.

h/in.	Part no.	\$/pc.
¼	ZBL349-286-060	11.10
⅜	ZBL349-286-080	11.10
½	ZBL349-286-100	11.10
⅝	ZBL349-286-110	11.10
¾	ZBL349-286-125	11.10

STAINLESS STEEL LOOK
POLISHED

Pack: 1 pc.

h/in.	Part no.	\$/pc.
¼	ZBL348-9286-060	6.15
⅜	ZBL348-9286-080	6.15
½	ZBL348-9286-100	6.15
⅝	ZBL348-9286-110	6.15
¾	ZBL348-9286-125	6.15

STAINLESS STEEL LOOK
POLISHED

Pack: 1 pc.

h/in.	Part no.	\$/pc.
¼	ZBL349-9286-060	6.15
⅜	ZBL349-9286-080	6.15
½	ZBL349-9286-100	6.15
⅝	ZBL349-9286-110	6.15
¾	ZBL349-9286-125	6.15

QUARTER CIRCLE TILE TRIM, FLAT CAP

STAINLESS STEEL
NATURAL

Pack: 1 pc.

h/in.	Part no.	\$/pc.
¼	ZBL350-280-060	17.60
⅜	ZBL350-280-080	19.03
½	ZBL350-280-100	19.69
⅝	ZBL350-280-110	20.13
¾	ZBL350-280-125	20.45
⅞	ZBL350-280-150	21.24

STAINLESS STEEL
POLISHED

Pack: 1 pc.

h/in.	Part no.	\$/pc.
¼	ZBL350-286-060	23.63
⅜	ZBL350-286-080	25.06
½	ZBL350-286-100	25.71
⅝	ZBL350-286-110	26.15
¾	ZBL350-286-125	26.47

STAINLESS STEEL
BRUSHED

Pack: 1 pc.

h/in.	Part no.	\$/pc.
¼	ZBL350-280B-060	23.63
⅜	ZBL350-280B-080	25.06
½	ZBL350-280B-100	25.71
⅝	ZBL350-280B-110	26.15
¾	ZBL350-280B-125	26.47





QUARTER CIRCLE TILE TRIM

QUARTER CIRCLE TRIMS are made of high-quality aluminum or PVC and bring decorative finishes and edge protection to tiled edges. The vertical joint spacer of QUARTER CIRCLE TILE TRIM provides superior structural strength and easy tile alignment. The variety of finishes available allows for ease in color coordination and creating decorative designs. Part numbers in **bold** indicate stocked Emser **Signature Series** items.

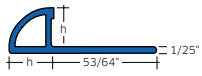

Aluminum

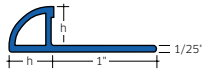

PVC

Advantages:

- > High quality
- > Structural support provided by an integrated vertical support piece under the curved profile (Extruded aluminum and PVC)
- > Superior weather resistance due to the durable baked-on plastic coating

Experts tip:

When ordering the QUARTER CIRCLE TILE TRIM please do not forget the inner and outer corners!



QUARTER CIRCLE TILE TRIM

ALUMINUM 8.0

SATIN SILVER, ANODIZED

Length: 8.0 feet Pack: 5 pcs.

h/in.	Part no.	\$/pc.
¼	ZBL347-410-06025	14.80
⅜	ZBL347-410-08025-1	16.92
½	ZBL347-410-10025-1	19.02
⅝	ZBL347-410-11025	20.16
¾	ZBL347-410-12525-1	22.70

QUARTER CIRCLE TILE TRIM, OUTER CORNERS

ALUMINUM SATIN SILVER, ANODIZED

Pack: 1 pc.

h/in.	Part no.	\$/pc.
¼	ZBL348-410AL-060	10.64
⅜	ZBL348-410AL-080	10.64
½	ZBL348-410AL-100	10.64
⅝	ZBL348-410AL-110	10.64
¾	ZBL348-410AL-125	10.64

QUARTER CIRCLE TILE TRIM, INNER CORNERS

ALUMINUM SATIN SILVER, ANODIZED

Pack: 1 pc.

h/in.	Part no.	\$/pc.
¼	ZBL349-410AL-060	14.31
⅜	ZBL349-410AL-080	14.31
½	ZBL349-410AL-100	14.31
⅝	ZBL349-410AL-110	14.31
¾	ZBL349-410AL-125	14.31

ALUMINUM LOOK SATIN SILVER

Pack: 1 pc.

h/in.	Part no.	\$/pc.
¼	ZBL348-410-060	6.15
⅜	ZBL348-410-080	6.15
½	ZBL348-410-100	6.15
⅝	ZBL348-410-110	6.15
¾	ZBL348-410-125	6.15

ALUMINUM LOOK SATIN SILVER

Pack: 1 pc.

h/in.	Part no.	\$/pc.
¼	ZBL349-410-060	6.15
⅜	ZBL349-410-080	6.15
½	ZBL349-410-100	6.15
⅝	ZBL349-410-110	6.15
¾	ZBL349-410-125	6.15

ALUMINUM 8.0

SHINY SILVER, ANODIZED

Length: 8.0 feet Pack: 5 pcs.

h/in.	Part no.	\$/pc.
¼	ZBL347-430-06025	17.49
⅜	ZBL347-430-08025	19.57
½	ZBL347-430-10025	22.07
⅝	ZBL347-430-11025	23.11
¾	ZBL347-430-12525-1	24.98

ALUMINUM LOOK SHINY SILVER

Pack: 1 pc.

h/in.	Part no.	\$/pc.
¼	ZBL348-930-060	6.15
⅜	ZBL348-930-080	6.15
½	ZBL348-930-100	6.15
⅝	ZBL348-930-110	6.15
¾	ZBL348-930-125-1	6.15

ALUMINUM LOOK SHINY SILVER

Pack: 1 pc.

h/in.	Part no.	\$/pc.
¼	ZBL349-930-060	6.15
⅜	ZBL349-930-080	6.15
½	ZBL349-930-100	6.15
⅝	ZBL349-930-110	6.15
¾	ZBL349-930-125-1	6.15

ALUMINUM 8.0

STAINLESS STEEL METALLIC, POWDER-COATED

Length: 8.0 feet Pack: 5 pcs.

h/in.	Part no.	\$/pc.
¼	ZBL347-4502-06025	16.35
⅜	ZBL347-4502-08025	18.52
½	ZBL347-4502-10025	20.75
⅝	ZBL347-4502-11025	21.64
¾	ZBL347-4502-12525	23.61

ALUMINUM LOOK STAINLESS STEEL METALLIC, POWDER-COATED

Pack: 1 pc.

h/in.	Part no.	\$/pc.
¼	ZBL348-9502-060	6.52
⅜	ZBL348-9502-080	6.52
½	ZBL348-9502-100	6.52
⅝	ZBL348-9502-110	6.52
¾	ZBL348-9502-125	6.52

ALUMINUM LOOK STAINLESS STEEL METALLIC, POWDER-COATED

Pack: 1 pc.

h/in.	Part no.	\$/pc.
¼	ZBL349-9502-060	6.52
⅜	ZBL349-9502-080	6.52
½	ZBL349-9502-100	6.52
⅝	ZBL349-9502-110	6.52
¾	ZBL349-9502-125	6.52

QUARTER CIRCLE TILE TRIM

ALUMINUM 8.0
SATIN GOLD, ANODIZED

Length: 8.0 feet Pack: 5 pcs.

h/in.	Part no.	\$/pc.
¼	ZBL347-420-06025	15.35
⅜	ZBL347-420-08025	17.48
½	ZBL347-420-10025	19.58
¾	ZBL347-420-12525	22.70

ALUMINUM 8.0
SHINY GOLD, ANODIZED

Length: 8.0 feet Pack: 5 pcs.

h/in.	Part no.	\$/pc.
¼	ZBL347-480-06025	17.25
⅜	ZBL347-480-08025	19.48
½	ZBL347-480-10025	21.69
¾	ZBL347-480-12525	25.04

ALUMINUM 8.0
JASMINE, POWDER-COATED

Length: 8.0 feet Pack: 5 pcs.

h/in.	Part no.	\$/pc.
¼	ZBL347-4501-06025	15.92
⅜	ZBL347-4501-08025-1	16.92
½	ZBL347-4501-10025	18.47
¾	ZBL347-4501-12525	20.13

ALUMINUM 8.0
WHITE, POWDER-COATED

Length: 8.0 feet Pack: 5 pcs.

h/in.	Part no.	\$/pc.
¼	ZBL347-450-06025	15.92
⅜	ZBL347-450-08025	16.92
½	ZBL347-450-10025	18.47
¾	ZBL347-450-11025	19.66
1	ZBL347-450-12525-1	20.13

ALUMINUM 8.0
MANHATTAN GRAY, POWDER-COATED

Length: 8.0 feet Pack: 5 pcs.

h/in.	Part no.	\$/pc.
¼	ZBL347-4591-06025	15.92
⅜	ZBL347-4591-08025	16.92
½	ZBL347-4591-10025	18.47
¾	ZBL347-4591-12525	20.13

ALUMINUM 8.0
GRAPHITE BLACK, POWDER-COATED

Length: 8.0 feet Pack: 5 pcs.

h/in.	Part no.	\$/pc.
¼	ZBL347-456-06025	15.92
⅜	ZBL347-456-08025-1	16.92
½	ZBL347-456-10025-1	18.47
¾	ZBL347-456-12525	20.13

QUARTER CIRCLE TILE
TRIM, OUTER CORNERS**ALUMINUM LOOK**
SATIN GOLD

Pack: 1 pc.

h/in.	Part no.	\$/pc.
¼	ZBL348-920-060	6.15
⅜	ZBL348-920-080	6.15
½	ZBL348-920-100	6.15
¾	ZBL348-920-125	6.15

ALUMINUM LOOK
SHINY GOLD

Pack: 1 pc.

h/in.	Part no.	\$/pc.
¼	ZBL348-980-060	6.15
⅜	ZBL348-980-080	6.15
½	ZBL348-980-100	6.15
¾	ZBL348-980-125	6.15

ALUMINUM LOOK
JASMINE, POWDER-COATED

Pack: 1 pc.

h/in.	Part no.	\$/pc.
¼	ZBL348-9501-060	6.15
⅜	ZBL348-9501-080	6.15
½	ZBL348-9501-100	6.15
¾	ZBL348-9501-125	6.15

ALUMINUM LOOK
WHITE, POWDER-COATED

Pack: 1 pc.

h/in.	Part no.	\$/pc.
¼	ZBL348-950-060	6.15
⅜	ZBL348-950-080	6.15
½	ZBL348-950-100	6.15
¾	ZBL348-950-110	6.15
1	ZBL348-950-125	6.15

ALUMINUM LOOK
MANHATTAN GRAY, POWDER-COATED

Pack: 1 pc.

h/in.	Part no.	\$/pc.
¼	ZBL348-9591-060	6.15
⅜	ZBL348-9591-080	6.15
½	ZBL348-9591-100	6.15
¾	ZBL348-9591-125	6.15

ALUMINUM LOOK
GRAPHITE BLACK, POWDER-COATED

Pack: 1 pc.

h/in.	Part no.	\$/pc.
¼	ZBL348-956-060	4.62
⅜	ZBL348-956-080	4.62
½	ZBL348-956-100	4.62
¾	ZBL348-956-125	4.62

QUARTER CIRCLE TILE
TRIM, INNER CORNERS**ALUMINUM LOOK**
SATIN GOLD

Pack: 1 pc.

h/in.	Part no.	\$/pc.
¼	ZBL349-920-060	6.15
⅜	ZBL349-920-080	6.15
½	ZBL349-920-100	6.15
¾	ZBL349-920-125	6.15

ALUMINUM LOOK
SHINY GOLD

Pack: 1 pc.

h/in.	Part no.	\$/pc.
¼	ZBL349-980-060	6.15
⅜	ZBL349-980-080	6.15
½	ZBL349-980-100	6.15
¾	ZBL349-980-125	6.15

ALUMINUM LOOK
JASMINE, POWDER-COATED

Pack: 1 pc.

h/in.	Part no.	\$/pc.
¼	ZBL349-9501-060	6.15
⅜	ZBL349-9501-080	6.15
½	ZBL349-9501-100	6.15
¾	ZBL349-9501-125	6.15

ALUMINUM LOOK
WHITE, POWDER-COATED

Pack: 1 pc.

h/in.	Part no.	\$/pc.
¼	ZBL349-950-060	6.15
⅜	ZBL349-950-080	6.15
½	ZBL349-950-100	6.15
¾	ZBL349-950-110	6.15
1	ZBL349-950-125	6.15

ALUMINUM LOOK
MANHATTAN GRAY, POWDER-COATED

Pack: 1 pc.

h/in.	Part no.	\$/pc.
¼	ZBL349-9591-060	6.15
⅜	ZBL349-9591-080	6.15
½	ZBL349-9591-100	6.15
¾	ZBL349-9591-125	6.15

ALUMINUM LOOK
GRAPHITE BLACK, POWDER-COATED

Pack: 1 pc.

h/in.	Part no.	\$/pc.
¼	ZBL349-956-060	4.62
⅜	ZBL349-956-080	4.62
½	ZBL349-956-100	4.62
¾	ZBL349-956-125	4.62

Experts tip:

When ordering the QUARTER CIRCLE TILE TRIM please do not forget the inner and outer corners!

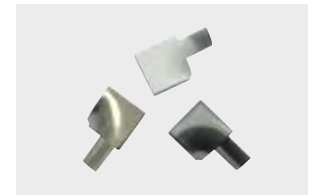

Experts tip:

When ordering the QUARTER CIRCLE TILE TRIM please do not forget the inner and outer corners!



QUARTER CIRCLE TILE TRIM

ALUMINUM 8.0
ROYAL CHAMPAGNE, ANODIZED

Length: 8.0 feet Pack: 5 pcs.

h/in.	Part no.	\$/pc.
¼	ZBL347-470-06025	17.23
⅜	ZBL347-470-08025	19.50
½	ZBL347-470-10025	21.91
⅝	ZBL347-470-11025	23.10
¾	ZBL347-470-12525	24.82

ALUMINUM 8.0
TITANIUM BRONZE, ANODIZED

Length: 8.0 feet Pack: 5 pcs.

h/in.	Part no.	\$/pc.
¼	ZBL347-446-06025	17.56
⅜	ZBL347-446-08025-1	19.50
½	ZBL347-446-10025	21.91
⅝	ZBL347-446-11025	23.10
¾	ZBL347-446-12525	24.82

ALUMINUM 8.0
OIL RUBBED BRONZE, ANODIZED

Length: 8.0 feet Pack: 5 pcs.

h/in.	Part no.	\$/pc.
⅜	ZBL347-449-08025	22.38
½	ZBL347-449-10025	23.01
⅝	ZBL347-449-11025	23.89
¾	ZBL347-449-12525	26.03

ALUMINUM 8.0
BRUSHED NICKEL, ANODIZED

Length: 8.0 feet Pack: 5 pcs.

h/in.	Part no.	\$/pc.
¼	ZBL347-420B-06025	20.52
⅜	ZBL347-420B-08025	21.97
½	ZBL347-420B-10025	24.12
⅝	ZBL347-420B-11025	24.62
¾	ZBL347-420B-12525	28.21

PVC 8.0
WHITE

Length: 8.0 feet Pack: 5 pcs.

h/in.	Part no.	\$/pc.
¼	ZBL347-501-06025-1	6.45
⅜	ZBL347-501-08025-1	6.67
½	ZBL347-501-10025-1	7.01
⅝	ZBL347-501-11025	7.44
¾	ZBL347-501-12525-1	8.60

QUARTER CIRCLE TILE TRIM, OUTER CORNERS

ALUMINUM LOOK 8.0
ROYAL CHAMPAGNE

Pack: 1 pc.

h/in.	Part no.	\$/pc.
¼	ZBL348-470-060	6.15
⅜	ZBL348-470-080	6.15
½	ZBL348-470-100	6.15
⅝	ZBL348-470-110	6.15
¾	ZBL348-470-125	6.15

ALUMINUM 8.0
TITANIUM BRONZE, ANODIZED

Pack: 1 pc.

h/in.	Part no.	\$/pc.
¼	ZBL348-446-060	10.30
⅜	ZBL348-446-080	10.30
½	ZBL348-446-100	10.30
⅝	ZBL348-446-110	10.30
¾	ZBL348-446-125	10.30

ALUMINUM 8.0
OIL RUBBED BRONZE, ANODIZED

Pack: 1 pc.

h/in.	Part no.	\$/pc.
⅜	ZBL348-449-080	11.76
½	ZBL348-449-100	11.76
⅝	ZBL348-449-110	11.76
¾	ZBL348-449-125	11.76

ALUMINUM LOOK 8.0
BRUSHED NICKEL

Pack: 1 pc.

h/in.	Part no.	\$/pc.
¼	ZBL348-420B-060	6.15
⅜	ZBL348-420B-080	6.15
½	ZBL348-420B-100	6.15
⅝	ZBL348-420B-110	6.15
¾	ZBL348-420B-125	6.15

PVC 8.0
WHITE

Pack: 1 pc.

h/in.	Part no.	\$/pc.
¼	ZBL348-501-060	2.15
⅜	ZBL348-501-080-1	2.15
½	ZBL348-501-100	2.15
⅝	ZBL348-501-110	2.15
¾	ZBL348-501-125-1	2.15

QUARTER CIRCLE TILE TRIM, INNER CORNERS

ALUMINUM LOOK 8.0
ROYAL CHAMPAGNE

Pack: 1 pc.

h/in.	Part no.	\$/pc.
¼	ZBL349-470-060	6.15
⅜	ZBL349-470-080	6.15
½	ZBL349-470-100	6.15
⅝	ZBL349-470-110	6.15
¾	ZBL349-470-125	6.15

ALUMINUM 8.0
TITANIUM BRONZE, ANODIZED

Pack: 1 pc.

h/in.	Part no.	\$/pc.
¼	ZBL349-446-060	10.30
⅜	ZBL349-446-080	10.30
½	ZBL349-446-100	10.30
⅝	ZBL349-446-110	10.30
¾	ZBL349-446-125	10.30

ALUMINUM 8.0
OIL RUBBED BRONZE, ANODIZED

Pack: 1 pc.

h/in.	Part no.	\$/pc.
⅜	ZBL349-449-080	11.76
½	ZBL349-449-100	11.76
⅝	ZBL349-449-110	11.76
¾	ZBL349-449-125	11.76

ALUMINUM LOOK 8.0
BRUSHED NICKEL

Pack: 1 pc.

h/in.	Part no.	\$/pc.
¼	ZBL349-420B-060	6.15
⅜	ZBL349-420B-080	6.15
½	ZBL349-420B-100	6.15
⅝	ZBL349-420B-110	6.15
¾	ZBL349-420B-125	6.15

PVC 8.0
WHITE

Pack: 1 pc.

h/in.	Part no.	\$/pc.
¼	ZBL349-501-060-1	2.15
⅜	ZBL349-501-080	2.15
½	ZBL349-501-100	2.15
⅝	ZBL349-501-110	2.15
¾	ZBL349-501-125-1	2.15

QUARTER CIRCLE TILE TRIM

PVC
JASMINE 8.0

Length: 8.0 feet Pack: 5 pcs.

h/in.	Part no.	\$/pc.
¼	ZBL347-5011-06025	6.45
⅜	ZBL347-5011-08025-1	6.67
½	ZBL347-5011-10025-1	7.01
⅝	ZBL347-5011-11025	7.44
¾	ZBL347-5011-12525-1	8.60

PVC
MANHATTAN GRAY 8.0

Length: 8.0 feet Pack: 5 pcs.

h/in.	Part no.	\$/pc.
¼	ZBL347-5091-06025	6.45
⅜	ZBL347-5091-08025	6.67
½	ZBL347-5091-10025	7.01
⅝	ZBL347-5091-11025	7.44
¾	ZBL347-5091-12525	8.60

PVC
SILVER GRAY 8.0

Length: 8.0 feet Pack: 5 pcs.

h/in.	Part no.	\$/pc.
¼	ZBL347-5092-06025	6.45
⅜	ZBL347-5092-08025	6.67
½	ZBL347-5092-10025	7.01
⅝	ZBL347-5092-11025	7.44

QUARTER CIRCLE TILE TRIM, OUTER CORNERS

PVC
JASMINE

Pack: 1 pc.

h/in.	Part no.	\$/pc.
¼	ZBL348-5011-060	2.15
⅜	ZBL348-5011-080	2.15
½	ZBL348-5011-100	2.15
⅝	ZBL348-5011-110	2.15
¾	ZBL348-5011-125	2.15

PVC
MANHATTAN GRAY

Pack: 1 pc.

h/in.	Part no.	\$/pc.
¼	ZBL348-5091-060	2.15
⅜	ZBL348-5091-080	2.15
½	ZBL348-5091-100	2.15
⅝	ZBL348-5091-110	2.15
¾	ZBL348-5091-125	2.15

PVC
SILVER GRAY

Pack: 1 pc.

h/in.	Part no.	\$/pc.
¼	ZBL348-5092-060	2.15
⅜	ZBL348-5092-080	2.15
½	ZBL348-5092-100	2.15
⅝	ZBL348-5092-110	2.15

QUARTER CIRCLE TILE TRIM, INNER CORNERS

PVC
JASMINE

Pack: 1 pc.

h/in.	Part no.	\$/pc.
¼	ZBL349-5011-060	2.15
⅜	ZBL349-5011-080	2.15
½	ZBL349-5011-100	2.15
⅝	ZBL349-5011-110	2.15
¾	ZBL349-5011-125-1	2.15

PVC
MANHATTAN GRAY

Pack: 1 pc.

h/in.	Part no.	\$/pc.
¼	ZBL349-5091-060	2.15
⅜	ZBL349-5091-080	2.15
½	ZBL349-5091-100	2.15
⅝	ZBL349-5091-110	2.15
¾	ZBL349-5091-125	2.15

PVC
SILVER GRAY

Pack: 1 pc.

h/in.	Part no.	\$/pc.
¼	ZBL349-5092-060	2.15
⅜	ZBL349-5092-080	2.15
½	ZBL349-5092-100	2.15
⅝	ZBL349-5092-110	2.15

Experts tip:

When ordering the QUARTER CIRCLE TILE TRIM please do not forget the inner and outer corners!





FLOOR ACCENT PROFILE

The FLOOR ACCENT PROFILES provide square outer corners and decorative accents for floor tiles and coves. Available in solid brass and in a variety of aluminum finishes (only the solid brass and natural aluminum should be used in floor applications), the FLOOR ACCENT PROFILES can also be used to form an attractive cove corner.

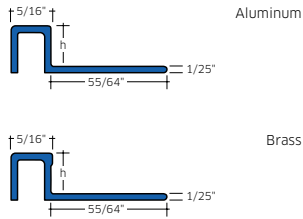

BRASS NATURAL 8.0

Length: 8.0 feet Pack: 5 pcs.

h/in.	Part no.	\$/pc.
1/32	ZBL304-300-09025	48.96
7/16	ZBL304-300-11025	52.85
1/2	ZBL304-300-12525-1	58.41
19/32	ZBL304-300-15025	63.42

BRASS CHROME-PLATED 8.0

Length: 8.0 feet Pack: 5 pcs.

h/in.	Part no.	\$/pc.
1/32	ZBL304-340-09025	126.85
7/16	ZBL304-340-11025	129.67
1/2	ZBL304-340-12525	136.94
19/32	ZBL304-340-15025	144.06

ALUMINUM NATURAL 8.0

Length: 8.0 feet Pack: 5 pcs.

h/in.	Part no.	\$/pc.
1/4	ZBL304-400-06025-1	16.14
5/16	ZBL304-400-08025	16.69
3/8	ZBL304-400-10025-1	17.25
1/2	ZBL304-400-12525	17.80
19/32	ZBL304-400-15025	18.91

ALUMINUM SATIN SILVER, ANODIZED 8.0

Length: 8.0 feet Pack: 5 pcs.

h/in.	Part no.	\$/pc.
1/4	ZBL304-410-06025	21.13
5/16	ZBL304-410-08025	22.81
3/8	ZBL304-410-10025-1	23.37
1/2	ZBL304-410-12525	25.60
19/32	ZBL304-410-15025	28.37

FLOOR ACCENT PROFILE (INNER AND OUTER CORNER)

BRASS CHROME-PLATED

Pack: 1 pc.

h/in.	Part no.	\$/pc.
1/32	ZBL652-340-090	25.03
7/16	ZBL652-340-110	25.64
1/2	ZBL652-340-125	30.15
19/32	ZBL652-340-150	31.91

CUBELINE

CUBELINE is a sleek tile edge protector that complements modern tile and stone designs. Unlike traditional edge protectors, this profile features a symmetrical cube shape. Several finishes are available which allow CUBELINE to provide decorative design and contrast. In addition to its decorative properties, CUBELINE also provides a durable protective edge for tile and stone applications. The chemical resistant stainless steel version even can be used as stairnose. Part numbers in **bold** indicate stocked Emser **Signature Series** items.

BRASS CHROME-PLATED

8.0

Length: 8.0 feet Pack: 5 pcs.

h/in.	Part no.	\$/pc.
3/16	ZBL740-340-04525	150.43
5/32	ZBL740-340-07025	157.25
1/8	ZBL740-340-09025	164.83
7/16	ZBL740-340-11025	170.95
1/2	ZBL740-340-12525	177.72
17/32	ZBL740-340-14025	197.35

STAINLESS STEEL NATURAL

8.0

Length: 8.0 feet Pack: 5 pcs.

h/in.	Part no.	\$/pc.
3/16	ZBL740-280-04525	41.18
5/32	ZBL740-280-07025	42.37
1/8	ZBL740-280-09025	44.01
3/8	ZBL740-280-10025	45.53
7/16	ZBL740-280-11025	46.11
1/2	ZBL740-280-12525	47.29
17/32	ZBL740-280-14025	50.37

STAINLESS STEEL POLISHED

8.0

Length: 8.0 feet Pack: 5 pcs.

h/in.	Part no.	\$/pc.
3/16	ZBL740-286-04525	58.23
5/32	ZBL740-286-07025	63.13
1/8	ZBL740-286-09025	67.64
3/8	ZBL740-286-10025	68.87
7/16	ZBL740-286-11025	72.35
1/2	ZBL740-286-12525	78.24
17/32	ZBL740-286-14025	85.21

STAINLESS STEEL BRUSHED

8.0

Length: 8.0 feet Pack: 5 pcs.

h/in.	Part no.	\$/pc.
3/16	ZBL740-280B-04525	56.83
5/32	ZBL740-280B-07025	61.51
1/8	ZBL740-280B-09025	66.85
3/8	ZBL740-280B-10025	68.87
7/16	ZBL740-280B-11025	71.79
1/2	ZBL740-280B-12525-1	76.50
17/32	ZBL740-280B-14025	83.56

STAINLESS STEEL CROSS BRUSHED

8.0

Length: 8.0 feet Pack: 5 pcs.

h/in.	Part no.	\$/pc.
5/32	ZBL740-280K-07025	61.51
1/8	ZBL740-280K-09025	66.85
7/16	ZBL740-280K-11025	71.79

ALUMINUM SATIN SILVER, ANODIZED

8.0

Length: 8.0 feet Pack: 5 pcs.

h/in.	Part no.	\$/pc.
3/16	ZBL740-410-04525	13.48
5/32	ZBL740-410-07025	16.07
1/8	ZBL740-410-09025	17.28
7/16	ZBL740-410-11025	19.03
1/2	ZBL740-410-12525	20.85
17/32	ZBL740-410-14025	22.46

ALUMINUM SHINY SILVER, ANODIZED

8.0

Length: 8.0 feet Pack: 5 pcs.

h/in.	Part no.	\$/pc.
3/16	ZBL740-430-04525	18.69
5/32	ZBL740-430-07025	21.08
1/8	ZBL740-430-09025	23.95
7/16	ZBL740-430-11025-1	26.41
1/2	ZBL740-430-12525-1	30.94
17/32	ZBL740-430-14025	31.63

ALUMINUM STAINLESS STEEL METALLIC, POWDER-COATED

8.0

Length: 8.0 feet Pack: 5 pcs.

h/in.	Part no.	\$/pc.
3/16	ZBL740-4502-04525	25.30
5/32	ZBL740-4502-07025	28.54
1/8	ZBL740-4502-09025	32.43
7/16	ZBL740-4502-11025	35.26
1/2	ZBL740-4502-12525	39.28
17/32	ZBL740-4502-14025	42.15

ALUMINUM TITANIUM BRONZE, ANODIZED

8.0

Length: 8.0 feet Pack: 5 pcs.

h/in.	Part no.	\$/pc.
3/16	ZBL740-446-04525	17.18
5/32	ZBL740-446-07025	17.91
1/8	ZBL740-446-09025-1	18.63
7/16	ZBL740-446-11025	19.15
1/2	ZBL740-446-12525	21.34
17/32	ZBL740-446-14025	22.95

ALUMINUM WHITE, POWDER-COATED

8.0

Length: 8.0 feet Pack: 5 pcs.

h/in.	Part no.	\$/pc.
3/16	ZBL740-450-04525	25.30
5/32	ZBL740-450-07025	28.54
1/8	ZBL740-450-09025	32.43
7/16	ZBL740-450-11025	35.26
1/2	ZBL740-450-12525	39.28
17/32	ZBL740-450-14025	42.15

ALUMINUM ROYAL CHAMPAGNE, ANODIZED

8.0

Length: 8.0 feet Pack: 5 pcs.

h/in.	Part no.	\$/pc.
3/16	ZBL740-470-04525	29.40
5/32	ZBL740-470-07025	32.92
1/8	ZBL740-470-09025-1	36.08
7/16	ZBL740-470-11025	39.24
1/2	ZBL740-470-12525	44.13
17/32	ZBL740-470-14025	47.84

ALUMINUM JASMINE, POWDER-COATED

8.0

Length: 8.0 feet Pack: 5 pcs.

h/in.	Part no.	\$/pc.
1/8	ZBL740-4501-09025	32.43
7/16	ZBL740-4501-11025	35.26
1/2	ZBL740-4501-12525	39.28

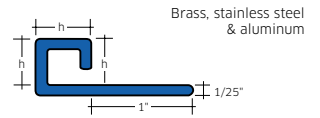



Expert tip:

When ordering the CUBELINE profile please do not forget the corners!



ALUMINUM 8.0		
SILVER, ANODIZED, CROSS BRUSHED		
Length: 8.0 feet		Pack: 5 pcs.
h/in.	Part no.	\$/pc.
3/16	ZBL740-430K-04525	44.10
1/2	ZBL740-430K-07025	45.74
11/32	ZBL740-430K-09025	47.38
7/16	ZBL740-430K-11025	53.12
1/2	ZBL740-430K-12525	56.00
17/32	ZBL740-430K-14025	58.66

ALUMINUM 8.0		
MATTE BLACK, ANODIZED		
Length: 8.0 feet		Pack: 5 pcs.
h/in.	Part no.	\$/pc.
1/2	ZBL740-416-07025	19.29
11/32	ZBL740-416-09025	20.74
7/16	ZBL740-416-11025	22.84
1/2	ZBL740-416-12525	25.03

ALUMINUM 8.0		
OIL RUBBED BRONZE, ANODIZED		
Length: 8.0 feet		Pack: 5 pcs.
h/in.	Part no.	\$/pc.
1/2	ZBL740-449-07025	20.82
11/32	ZBL740-449-09025	22.12
7/16	ZBL740-449-11025	23.11
1/2	ZBL740-449-12525	25.30

ALUMINUM 8.0		
BRUSHED NICKEL, ANODIZED		
Length: 8.0 feet		Pack: 5 pcs.
h/in.	Part no.	\$/pc.
1/2	ZBL740-420B-07025	22.85
11/32	ZBL740-420B-09025-1	24.98
7/16	ZBL740-420B-11025	27.07
1/2	ZBL740-420B-12525	31.02
17/32	ZBL740-420B-14025	33.98

ALUMINUM 8.0		
SATIN SILVER, BRUSHED ANODIZED		
Length: 8.0 feet		Pack: 5 pcs.
h/in.	Part no.	\$/pc.
3/16	ZBL740-410B-04525	34.19
1/2	ZBL740-410B-07025	35.85
11/32	ZBL740-410B-09025	38.02
7/16	ZBL740-410B-11025	39.43
1/2	ZBL740-410B-12525	40.93
17/32	ZBL740-410B-14025	41.76

ALUMINUM 8.0		
MATTE BLACK, BRUSHED ANODIZED		
Length: 8.0 feet		Pack: 5 pcs.
h/in.	Part no.	\$/pc.
3/16	ZBL740-416B-04525	41.47
1/2	ZBL740-416B-07025	43.06
11/32	ZBL740-416B-09025	45.05
7/16	ZBL740-416B-11025	46.43
1/2	ZBL740-416B-12525	47.80
17/32	ZBL740-416B-14025	48.55

ALUMINUM 8.0		
SATIN GOLD, ANODIZED		
Length: 8.0 feet		Pack: 5 pcs.
h/in.	Part no.	\$/pc.
3/16	ZBL740-420-04525	21.40
1/2	ZBL740-420-07025	23.07
11/32	ZBL740-420-09025	25.23
7/16	ZBL740-420-11025	26.65
1/2	ZBL740-420-12525	28.15
17/32	ZBL740-420-14025	28.98

ALUMINUM 8.0		
SATIN GOLD, BRUSHED ANODIZED		
Length: 8.0 feet		Pack: 5 pcs.
h/in.	Part no.	\$/pc.
3/16	ZBL740-42GB-04525	35.60
1/2	ZBL740-42GB-07025	37.27
11/32	ZBL740-42GB-09025	39.43
7/16	ZBL740-42GB-11025	40.89
1/2	ZBL740-42GB-12525	42.35
17/32	ZBL740-42GB-14025	43.18

ALUMINUM 8.0		
TITANIUM BRONZE, BRUSHED ANODIZED		
Length: 8.0 feet		Pack: 5 pcs.
h/in.	Part no.	\$/pc.
3/16	ZBL740-446B-04525	41.47
1/2	ZBL740-446B-07025	43.06
11/32	ZBL740-446B-09025	45.05
7/16	ZBL740-446B-11025	46.43
1/2	ZBL740-446B-12525	47.80
17/32	ZBL740-446B-14025	48.55

ALUMINUM 8.0		
ROYAL CHAMPAGNE, BRUSHED ANODIZED		
Length: 8.0 feet		Pack: 5 pcs.
h/in.	Part no.	\$/pc.
3/16	ZBL740-470B-04525	35.60
1/2	ZBL740-470B-07025	37.27
11/32	ZBL740-470B-09025	39.43
7/16	ZBL740-470B-11025	40.89
1/2	ZBL740-470B-12525	42.35
17/32	ZBL740-470B-14025	43.18

ALUMINUM 8.0		
SAND TROPEZ, TEXTURED POWDER-COATED		
Length: 8.0 feet		Pack: 5 pcs.
h/in.	Part no.	\$/pc.
11/32	ZBL740-4571A-09025	33.73
7/16	ZBL740-4571A-11025	35.39
1/2	ZBL740-4571A-12525	36.23

ALUMINUM 8.0		
STONE GRAY, TEXTURED POWDER-COATED		
Length: 8.0 feet		Pack: 5 pcs.
h/in.	Part no.	\$/pc.
11/32	ZBL740-4591A-09025	33.73
7/16	ZBL740-4591A-11025	35.39
1/2	ZBL740-4591A-12525	36.23

ALUMINUM 8.0		
GRAPHITE, TEXTURED POWDER-COATED		
Length: 8.0 feet		Pack: 5 pcs.
h/in.	Part no.	\$/pc.
11/32	ZBL740-4561A-09025	33.73
7/16	ZBL740-4561A-11025	35.39
1/2	ZBL740-4561A-12525	36.23

ALUMINUM 8.0		
OXIDE, TEXTURED POWDER-COATED		
Length: 8.0 feet		Pack: 5 pcs.
h/in.	Part no.	\$/pc.
11/32	ZBL740-4581A-09025	33.73
7/16	ZBL740-4581A-11025	35.39
1/2	ZBL740-4581A-12525	36.23

ALUMINUM 8.0		
SUGAR WHITE, TEXTURED POWDER-COATED		
Length: 8.0 feet		Pack: 5 pcs.
h/in.	Part no.	\$/pc.
11/32	ZBL740-4512A-09025	33.73
7/16	ZBL740-4512A-11025	35.39
1/2	ZBL740-4512A-12525	36.23

ALUMINUM 8.0		
QUARTZ, TEXTURED POWDER-COATED		
Length: 8.0 feet		Pack: 5 pcs.
h/in.	Part no.	\$/pc.
1/32	ZBL740-4521A-09025	33.73
7/16	ZBL740-4521A-11025	35.39
1/2	ZBL740-4521A-12525	36.23

ALUMINUM 8.0		
OYSTER WHITE, TEXTURED POWDER-COATED		
Length: 8.0 feet		Pack: 5 pcs.
h/in.	Part no.	\$/pc.
1/32	ZBL740-4511A-09025	33.73
7/16	ZBL740-4511A-11025	35.39
1/2	ZBL740-4511A-12525	36.23

ALUMINUM 8.0		
INDUSTRIAL RUST, TEXTURED POWDER-COATED		
Length: 8.0 feet		Pack: 5 pcs.
h/in.	Part no.	\$/pc.
1/32	ZBL740-4583A-09025	33.73
7/16	ZBL740-4583A-11025	35.39
1/2	ZBL740-4583A-12525	36.23



Experts tip:
When ordering the CUBELINE profile please do not forget the corners!

ALUMINUM 8.0		
COAL BLACK, TEXTURED POWDER-COATED		
Length: 8.0 feet		Pack: 5 pcs.
h/in.	Part no.	\$/pc.
1/32	ZBL740-4562A-09025	33.73
7/16	ZBL740-4562A-11025	35.39
1/2	ZBL740-4562A-12525	36.23

ALUMINUM 8.0		
DARK CHOCOLATE, TEXTURED POWDER-COATED		
Length: 8.0 feet		Pack: 5 pcs.
h/in.	Part no.	\$/pc.
1/32	ZBL740-4582A-09025	33.73
7/16	ZBL740-4582A-11025	35.39
1/2	ZBL740-4582A-12525	36.23



CUBELINE, corner piece (inner and outer corner)

BRASS 8.0		
CHROME-PLATED		
Pack: 1 pc.		
h/in.	Part no.	\$/pc.
3/16	ZBL741-340-045	16.64
5/32	ZBL741-340-070	17.61
1/32	ZBL741-340-090	19.57
7/16	ZBL741-340-110	22.19
1/2	ZBL741-340-125	22.78
17/32	ZBL741-340-140	25.02

STAINLESS STEEL 8.0		
NATURAL		
Pack: 1 pc.		
h/in.	Part no.	\$/pc.
3/16	ZBL741-280-045	28.67
5/32	ZBL741-280-070	30.37
1/32	ZBL741-280-090	33.74
3/8	ZBL741-280-100	36.27
7/16	ZBL741-280-110	38.27
1/2	ZBL741-280-125	39.28
17/32	ZBL741-280-140	43.12

STAINLESS STEEL 8.0		
BRUSHED		
Pack: 1 pc.		
h/in.	Part no.	\$/pc.
3/16	ZBL741-280B-045	36.13
5/32	ZBL741-280B-070	38.25
1/32	ZBL741-280B-090	42.50
3/8	ZBL741-280B-100	44.69
7/16	ZBL741-280B-110	45.91
1/2	ZBL741-280B-125	47.83
17/32	ZBL741-280B-140	53.04

STAINLESS STEEL 8.0		
POLISHED		
Pack: 1 pc.		
h/in.	Part no.	\$/pc.
3/16	ZBL741-286-045	36.13
5/32	ZBL741-286-070	38.25
1/32	ZBL741-286-090	42.50
3/8	ZBL741-286-100	44.27
7/16	ZBL741-286-110	45.91
1/2	ZBL741-286-125	47.04
17/32	ZBL741-286-140	53.36

STAINLESS STEEL 8.0		
CROSS BRUSHED		
Pack: 1 pc.		
h/in.	Part no.	\$/pc.
5/32	ZBL741-280K-070	38.25
17/32	ZBL741-280K-090	42.50
7/16	ZBL741-280K-110	45.91

ALUMINUM 8.0		
SATIN SILVER		
Pack: 1 pc.		
h/in.	Part no.	\$/pc.
3/16	ZBL741-410AL-045	16.86
5/32	ZBL741-410AL-070	16.86
1/32	ZBL741-410AL-090	16.86
7/16	ZBL741-410AL-110	16.86
1/2	ZBL741-410AL-125	16.86
17/32	ZBL741-410AL-140	16.86

ALUMINUM LOOK 8.0		
SATIN SILVER		
Pack: 1 pc.		
h/in.	Part no.	\$/pc.
3/16	ZBL741-410-045	7.63
5/32	ZBL741-410-070	7.63
17/32	ZBL741-410-090-1	7.63
7/16	ZBL741-410-110	7.63
1/2	ZBL741-410-125	7.63
17/32	ZBL741-410-140	7.63

ALUMINUM LOOK 8.0		
SHINY SILVER		
Pack: 1 pc.		
h/in.	Part no.	\$/pc.
3/16	ZBL741-430-045	9.12
5/32	ZBL741-430-070	9.12
17/32	ZBL741-430-090	9.12
7/16	ZBL741-430-110	9.12
1/2	ZBL741-430-125-1	9.12
17/32	ZBL741-430-140	9.12

ALUMINUM LOOK 8.0		
STAINLESS STEEL METALLIC, POWDER-COATED		
Pack: 1 pc.		
h/in.	Part no.	\$/pc.
3/16	ZBL741-4502-045	7.63
5/32	ZBL741-4502-070	7.63
17/32	ZBL741-4502-090	7.63
7/16	ZBL741-4502-110	7.63
1/2	ZBL741-4502-125	7.63
17/32	ZBL741-4502-140	7.63



Expert tip:

When ordering the CUBELINE profile please do not forget the inner and outer corners!



ALUMINUM
SILVER, ANODIZED, CROSS BRUSHED

Pack: 1 pc.

h/in.	Part no.	\$/pc.
3/16	ZBL741-430K-045	15.39
5/32	ZBL741-430K-070	15.39
11/32	ZBL741-430K-090	15.39
7/16	ZBL741-430K-110	15.39
1/2	ZBL741-430K-125	15.39
17/32	ZBL741-430K-140	15.39

ALUMINUM
MATTE BLACK, ANODIZED

Pack: 1 pc.

h/in.	Part no.	\$/pc.
5/32	ZBL741-416-070	12.51
11/32	ZBL741-416-090	12.51
7/16	ZBL741-416-110	12.51
1/2	ZBL741-416-125	12.51

ALUMINUM
OIL RUBBED BRONZE, ANODIZED

Pack: 1 pc.

h/in.	Part no.	\$/pc.
5/32	ZBL741-449-070	18.37
11/32	ZBL741-449-090	18.37
7/16	ZBL741-449-110	18.37
1/2	ZBL741-449-125	18.37

STAINLESS STEEL LOOK
BRUSHED

Pack: 1 pc.

h/in.	Part no.	\$/pc.
3/16	ZBL741-928B-045	5.37
5/32	ZBL741-928B-070	5.37
11/32	ZBL741-928B-090	5.37
3/8	ZBL741-928B-100	5.37
7/16	ZBL741-928B-110	5.37
1/2	ZBL741-928B-125	5.37
17/32	ZBL741-928B-140	5.37

ALUMINUM
MATTE BLACK, BRUSHED ANODIZED

Pack: 1 pc.

h/in.	Part no.	\$/pc.
3/16	ZBL741-416B-045	17.03
5/32	ZBL741-416B-070	17.03
11/32	ZBL741-416B-090	17.03
7/16	ZBL741-416B-110	17.03
1/2	ZBL741-416B-125	17.03
17/32	ZBL741-416B-140	17.03

ALUMINUM LOOK
JASMINE, POWDER-COATED

Pack: 1 pc.

h/in.	Part no.	\$/pc.
5/32	ZBL741-4501-090	9.12
7/16	ZBL741-4501-110	9.12
1/2	ZBL741-4501-125	9.12

ALUMINUM LOOK
ROYAL CHAMPAGNE, POWDER-COATED

Pack: 1 pc.

h/in.	Part no.	\$/pc.
3/16	ZBL741-470-045	9.62
5/32	ZBL741-470-070	9.62
11/32	ZBL741-470-090	9.62
7/16	ZBL741-470-110	9.62
1/2	ZBL741-470-125	9.62
17/32	ZBL741-470-140	9.62

ALUMINUM LOOK
BRUSHED NICKEL, ANODIZED

Pack: 1 pc.

h/in.	Part no.	\$/pc.
5/32	ZBL741-420B-070	11.97
11/32	ZBL741-420B-090	11.97
7/16	ZBL741-420B-110	11.97
1/2	ZBL741-420B-125	11.97
17/32	ZBL741-420B-140	11.97

STAINLESS STEEL LOOK
POLISHED

Pack: 1 pc.

h/in.	Part no.	\$/pc.
3/16	ZBL741-9286-045	5.37
5/32	ZBL741-9286-070	5.37
11/32	ZBL741-9286-090	5.37
3/8	ZBL741-9286-100	5.37
7/16	ZBL741-9286-110	5.37
1/2	ZBL741-9286-125	5.37
17/32	ZBL741-9286-140	5.37

ALUMINUM
SATIN GOLD, ANODIZED

Pack: 1 pc.

h/in.	Part no.	\$/pc.
3/16	ZBL741-420-045	15.41
5/32	ZBL741-420-070	15.41
11/32	ZBL741-420-090	15.41
7/16	ZBL741-420-110	15.41
1/2	ZBL741-420-125	15.41
17/32	ZBL741-420-140	15.41

ALUMINUM LOOK
WHITE, POWDER-COATED

Pack: 1 pc.

h/in.	Part no.	\$/pc.
3/16	ZBL741-450-045	9.12
5/32	ZBL741-450-070	9.12
11/32	ZBL741-450-090	9.12
7/16	ZBL741-450-110	9.12
1/2	ZBL741-450-125	9.12
17/32	ZBL741-450-140	9.12

ALUMINUM
TITANIUM BRONZE, ANODIZED

Pack: 1 pc.

h/in.	Part no.	\$/pc.
3/16	ZBL741-446-045	11.92
5/32	ZBL741-446-070	11.92
11/32	ZBL741-446-090-1	11.92
7/16	ZBL741-446-110	11.92
1/2	ZBL741-446-125	11.92
17/32	ZBL741-446-140	11.92

STAINLESS STEEL LOOK
NATURAL

Pack: 1 pc.

h/in.	Part no.	\$/pc.
3/16	ZBL741-9280-045	3.82
5/32	ZBL741-9280-070	3.82
11/32	ZBL741-9280-090	3.82
3/8	ZBL741-9280-100	3.82
7/16	ZBL741-9280-110	3.82
1/2	ZBL741-9280-125	3.82
17/32	ZBL741-9280-140	3.82

ALUMINUM
SATIN SILVER, BRUSHED ANODIZED

Pack: 1 pc.

h/in.	Part no.	\$/pc.
3/16	ZBL741-410B-045	17.03
5/32	ZBL741-410B-070	17.03
11/32	ZBL741-410B-090	17.03
7/16	ZBL741-410B-110	17.03
1/2	ZBL741-410B-125	17.03
17/32	ZBL741-410B-140	17.03

ALUMINUM
SATIN GOLD, BRUSHED ANODIZED

Pack: 1 pc.

h/in.	Part no.	\$/pc.
3/16	ZBL741-42GB-045	17.03
5/32	ZBL741-42GB-070	17.03
11/32	ZBL741-42GB-090	17.03
7/16	ZBL741-42GB-110	17.03
1/2	ZBL741-42GB-125	17.03
17/32	ZBL741-42GB-140	17.03

ALUMINUM
 TITANIUM BRONZE,
 BRUSHED ANODIZED

Pack: 1 pc.

h/in.	Part no.	\$/pc.
3/16	ZBL741-446B-045	17.03
5/32	ZBL741-446B-070	17.03
1/8	ZBL741-446B-090	17.03
7/16	ZBL741-446B-110	17.03
1/2	ZBL741-446B-125	17.03
17/32	ZBL741-446B-140	17.03

ALUMINUM
 ROYAL CHAMPAGNE,
 BRUSHED ANODIZED

Pack: 1 pc.

h/in.	Part no.	\$/pc.
3/16	ZBL741-470B-045	17.03
5/32	ZBL741-470B-070	17.03
1/8	ZBL741-470B-090	17.03
7/16	ZBL741-470B-110	17.03
1/2	ZBL741-470B-125	17.03
17/32	ZBL741-470B-140	17.03

ALUMINUM LOOK
 SAND TROPEZ, TEXTURED
 POWDER-COATED

Pack: 1 pc.

h/in.	Part no.	\$/pc.
1/8	ZBL741-9571A-090	5.00
7/16	ZBL741-9571A-110	5.00
1/2	ZBL741-9571A-125	5.00

**Expert tip:**

When ordering the CUBELINE profile please do not forget the inner and outer corners!

ALUMINUM LOOK
 STONE GRAY, TEXTURED
 POWDER-COATED

Pack: 1 pc.

h/in.	Part no.	\$/pc.
1/8	ZBL741-9591A-090	5.00
7/16	ZBL741-9591A-110	5.00
1/2	ZBL741-9591A-125	5.00

ALUMINUM LOOK
 GRAPHITE, TEXTURED
 POWDER-COATED

Pack: 1 pc.

h/in.	Part no.	\$/pc.
1/8	ZBL741-9561A-090	5.00
7/16	ZBL741-9561A-110	5.00
1/2	ZBL741-9561A-125	5.00

ALUMINUM LOOK
 OXIDE, TEXTURED
 POWDER-COATED

Pack: 1 pc.

h/in.	Part no.	\$/pc.
1/8	ZBL741-9581A-090	5.00
7/16	ZBL741-9581A-110	5.00
1/2	ZBL741-9581A-125	5.00

ALUMINUM LOOK
 SUGAR WHITE, TEXTURED
 POWDER-COATED

Pack: 1 pc.

h/in.	Part no.	\$/pc.
1/8	ZBL741-9512A-090	5.00
7/16	ZBL741-9512A-110	5.00
1/2	ZBL741-9512A-125	5.00

ALUMINUM LOOK
 QUARTZ, TEXTURED
 POWDER-COATED

Pack: 1 pc.

h/in.	Part no.	\$/pc.
1/8	ZBL741-9521A-090	5.00
7/16	ZBL741-9521A-110	5.00
1/2	ZBL741-9521A-125	5.00

ALUMINUM LOOK
 OYSTER WHITE, TEXTURED
 POWDER-COATED

Pack: 1 pc.

h/in.	Part no.	\$/pc.
1/8	ZBL741-9511A-090	5.00
7/16	ZBL741-9511A-110	5.00
1/2	ZBL741-9511A-125	5.00

ALUMINUM LOOK
 INDUSTRIAL RUST, TEXTURED
 POWDER-COATED

Pack: 1 pc.

h/in.	Part no.	\$/pc.
1/8	ZBL741-9583A-090	5.00
7/16	ZBL741-9583A-110	5.00
1/2	ZBL741-9583A-125	5.00

ALUMINUM LOOK
 COAL BLACK, TEXTURED
 POWDER-COATED

Pack: 1 pc.

h/in.	Part no.	\$/pc.
1/8	ZBL741-9562A-090	5.00
7/16	ZBL741-9562A-110	5.00
1/2	ZBL741-9562A-125	5.00

ALUMINUM LOOK
 DARK CHOCOLATE, TEXTURED
 POWDER-COATED

Pack: 1 pc.

h/in.	Part no.	\$/pc.
1/8	ZBL741-9582A-090	5.00
7/16	ZBL741-9582A-110	5.00
1/2	ZBL741-9582A-125	5.00



DECOLINE

DECOLINE is a profile that provides decorative borders for tiled walls. DECOLINE can be combined with the corresponding finish in the QUARTER CIRCLE TILE TRIM for corners for a coordinated and professional installation. The DECOLINE made from stainless steel is durable enough to be used as accents in floor tile installation.

Brass & Aluminum

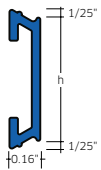

Stainless steel

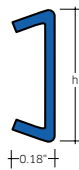

Advantages:

One size fits tile as thin as 3/16" - suitable for mosaic tiles

BRASS CHROME-PLATED 8.0		
Length: 8.0 feet		Pack: 2 pcs.
h/in.	Part no.	\$/pc.
1	ZBL622-340-25250	136.94

STAINLESS STEEL BRUSHED 8.0		
Length: 8.0 feet		Pack: 2 pcs.
h/in.	Part no.	\$/pc.
1	ZBL622-280B-25250	121.79

ALUMINUM SATIN GOLD, ANODIZED 8.0		
Length: 8.0 feet		Pack: 2 pcs.
h/in.	Part no.	\$/pc.
1	ZBL622-420-25250	43.17

ALUMINUM SHINY GOLD, ANODIZED 8.0		
Length: 8.0 feet		Pack: 2 pcs.
h/in.	Part no.	\$/pc.
1	ZBL622-480-25250	64.89

ALUMINUM SATIN SILVER, ANODIZED 8.0		
Length: 8.0 feet		Pack: 2 pcs.
h/in.	Part no.	\$/pc.
1	ZBL622-410-25250-1	43.17

ALUMINUM SHINY SILVER, ANODIZED 8.0		
Length: 8.0 feet		Pack: 2 pcs.
h/in.	Part no.	\$/pc.
1	ZBL622-430-25250	64.89



CORNER PRO

The CORNER PRO is designed where tiled wall corners need to be protected from mechanical impact in industrial and professional environments. The profile creates a strong edge with a clean and decorative finish for outside wall corners.

Stainless steel

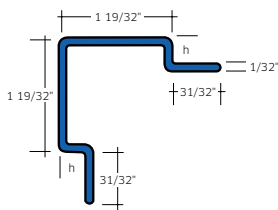

STAINLESS STEEL BRUSHED 8.0		
Length: 8.0 feet		Pack: 1 pc.
h/in.	Part no.	\$/pc.
5/16	ZBL197-280-08025	162.26
3/8	ZBL197-280-10025	162.26

STAINLESS STEEL BRUSHED 6.7		
Length: 6.7 feet		Pack: 1 pc.
h/in.	Part no.	\$/pc.
5/16	ZBL197-280-0802	143.99
3/8	ZBL197-280-1002	143.99

STAINLESS STEEL BRUSHED 4.11		
Length: 4.11 feet		Pack: 1 pc.
h/in.	Part no.	\$/pc.
5/16	ZBL197-280-08015	133.46
3/8	ZBL197-280-10015	133.46

CORNER ANGLE

The CORNER ANGLES are designed where tiled wall corners need to be protected from mechanical impact in industrial and professional environments. The stainless steel profile creates a strong edge with a clean and decorative finish for outside wall corners. The double-backed glue strips allow CORNER ANGLE profiles to adhere directly to the wall tile for easy installation.

STAINLESS STEEL 8.0 BRUSHED, WITH GLUE STRIP

Length: 8.0 feet Pack: 1 pc.

h/in.	Part no.	\$/pc.
1 $\frac{3}{16}$ × 1 $\frac{3}{16}$	ZBL364-280-03025-1	89.58
1 $\frac{3}{8}$ × 1 $\frac{3}{8}$	ZBL364-280-04025	112.81
2 $\frac{3}{25}$ × 2 $\frac{3}{25}$	ZBL364-280-06025	136.03

STAINLESS STEEL 6.7 BRUSHED, WITH GLUE STRIP

Length: 6.7 feet Pack: 1 pc.

h/in.	Part no.	\$/pc.
1 $\frac{3}{16}$ × 1 $\frac{3}{16}$	ZBL364-280-0302	83.67
1 $\frac{3}{8}$ × 1 $\frac{3}{8}$	ZBL364-280-0402	102.34
2 $\frac{3}{25}$ × 2 $\frac{3}{25}$	ZBL364-280-0602	124.88

STAINLESS STEEL 4.11 BRUSHED, WITH GLUE STRIP

Length: 4.11 feet Pack: 1 pc.

h/in.	Part no.	\$/pc.
1 $\frac{3}{16}$ × 1 $\frac{3}{16}$	ZBL364-280-03015	59.92
1 $\frac{3}{8}$ × 1 $\frac{3}{8}$	ZBL364-280-04015	80.43
2 $\frac{3}{25}$ × 2 $\frac{3}{25}$	ZBL364-280-06015	88.36

STAINLESS STEEL 8.0 BRUSHED, WITHOUT GLUE STRIP

Length: 8.0 feet Pack: 1 pc.

h/in.	Part no.	\$/pc.
1 $\frac{3}{16}$ × 1 $\frac{3}{16}$	ZBL448-280-03025	86.66
1 $\frac{3}{8}$ × 1 $\frac{3}{8}$	ZBL448-280-04025	109.51
2 $\frac{3}{25}$ × 2 $\frac{3}{25}$	ZBL448-280-06025	132.31

STAINLESS STEEL 6.7 BRUSHED, WITHOUT GLUE STRIP

Length: 6.7 feet Pack: 1 pc.

h/in.	Part no.	\$/pc.
1 $\frac{3}{16}$ × 1 $\frac{3}{16}$	ZBL448-280-0302	72.99
1 $\frac{3}{8}$ × 1 $\frac{3}{8}$	ZBL448-280-0402	94.90
2 $\frac{3}{25}$ × 2 $\frac{3}{25}$	ZBL448-280-0602	115.78

STAINLESS STEEL 4.11 BRUSHED, WITHOUT GLUE STRIP

Length: 4.11 feet Pack: 1 pc.

h/in.	Part no.	\$/pc.
1 $\frac{3}{16}$ × 1 $\frac{3}{16}$	ZBL448-280-03015	52.01
1 $\frac{3}{8}$ × 1 $\frac{3}{8}$	ZBL448-280-04015	74.90
2 $\frac{3}{25}$ × 2 $\frac{3}{25}$	ZBL448-280-06015	82.38

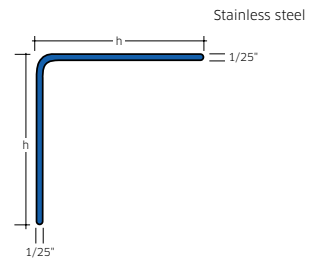

CORNER ANGLE PLUS

The CORNER ANGLE PLUS is designed where tiled wall corners need to be protected from mechanical impact in industrial and professional environments. The stainless steel profile creates a strong edge with a clean and decorative finish for outside wall corners.

STAINLESS STEEL 8.0 BRUSHED, WITHOUT GLUE STRIP

Length: 8.0 feet Pack: 1 pc.

h/in.	Part no.	\$/pc.
1 $\frac{3}{16}$ × 1 $\frac{3}{16}$	ZBL451-280-03025	133.33
1 $\frac{3}{8}$ × 1 $\frac{3}{8}$	ZBL451-280-04025	162.97

STAINLESS STEEL 6.7 BRUSHED, WITHOUT GLUE STRIP

Length: 6.7 feet Pack: 1 pc.

h/in.	Part no.	\$/pc.
1 $\frac{3}{16}$ × 1 $\frac{3}{16}$	ZBL451-280-03020	104.00
1 $\frac{3}{8}$ × 1 $\frac{3}{8}$	ZBL451-280-04020	132.00

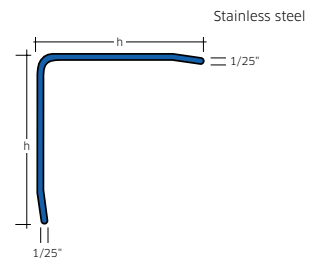

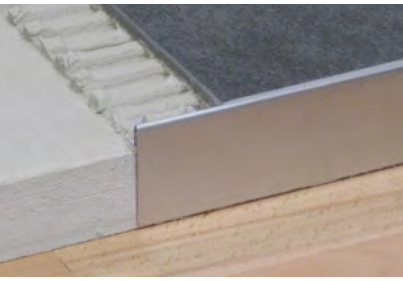

SILL PROFILE

The SILL PROFILE of stainless steel is specifically designed to cover the tiled edge of stairs and countertops where there is a buildup of exposed substrate and underlayment. The brushed exposed face of the profile creates a visually attractive finish while providing long lasting low maintenance protection for the tile edge.

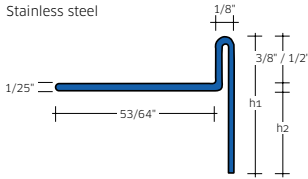

STAINLESS STEEL 10.0 BRUSHED

Inner height: 3/8 inch; length: 10 feet Pack: 1 pc.

h1/in.	h2/in.	Part no.	\$/pc.
5/64	3/8	ZBL757-280B-10213	142.44
1	19/32	ZBL757-280B-10263	146.01
1 3/16	3/4	ZBL757-280B-10313	149.56
1 1/2	1 3/8	ZBL757-280B-10463	162.03

STAINLESS STEEL 3.3 BRUSHED

Inner height: 3/8 inch; length: 3.3 feet Pack: 1 pc.

h1/in.	h2/in.	Part no.	\$/pc.
5/64	3/8	ZBL757-280B-10211	61.11
1	19/32	ZBL757-280B-10261	61.45
1 3/16	3/4	ZBL757-280B-10311	63.01
1 1/2	1 3/8	ZBL757-280B-10461	67.81

STAINLESS STEEL 10.0 BRUSHED

Inner height: 1/2 inch; length: 10 feet Pack: 1 pc.

h1/in.	h2/in.	Part no.	\$/pc.
3/10	3/8	ZBL757-280B-12233	146.01
1 1/10	19/32	ZBL757-280B-12283	149.56
1 3/10	3/4	ZBL757-280B-12333	154.92
1 3/10	1 3/8	ZBL757-280B-12483	165.56

STAINLESS STEEL 3.3 BRUSHED

Inner height: 1/2 inch; length: 3.3 feet Pack: 1 pc.

h1/in.	h2/in.	Part no.	\$/pc.
3/10	3/8	ZBL757-280B-12231	61.49
1 1/10	19/32	ZBL757-280B-12281	63.01
1 3/10	3/4	ZBL757-280B-12331	64.80
1 3/10	1 3/8	ZBL757-280B-12481	69.21



F-PROFILE

F-PROFILE is an aluminum tile trim that creates a 1/2" wide channel that can be used for the decorative purposes of creating a shadow gap. This unique trim can also be used for supporting glass walls, and is available in different heights to work with your tile selection.



ALUMINUM 8.0 SATIN SILVER, ANODIZED

Length: 8.0 feet Pack: 1 pc.

h/in.	Part no.	\$/pc.
3/32	ZBL292-410-07025	28.21
11/32	ZBL292-410-09025	28.63
3/16	ZBL292-410-11025	29.47





Network™ | Taupe



NEW YORK EDITION

The tried-and-trusted design, plus daring new trend-setting colours and surface textures are compelling features of the NEW YORK series of profiles. As they combine perfectly with the latest tiling trends, the profile series is precisely the right choice for those who prefer design-oriented styles. In addition to the proven tile edge protection and the new color schemes, the high-quality surface textures offer a new tactile experience.

The brushed version of the edge protector trim of the NEW YORK EDITION is available in Satin Gold, Satin Silver, Titanium Bronze, Royal Champagne and Matte Black. The profile is also available with Stone Gray, Oxide, Sand Tropez and Graphite textured finishes. The design-oriented profile line CUBELINE offers a Satin Silver anodized, cross-brushed version, as well as versions in Sugar White, Oyster White, Quartz, Industrial Rust, Dark Chocolate and Coal Black.

No matter whether you prefer classic, modern or avant-garde, with this unique profile design: ***You will be thrilled with the NEW YORK EDITION and its proven design and daring, trend-setting colors.***



NEW YORK EDITION

EDGE PROTECTOR TRIM

ALUMINUM 8.0		
SATIN GOLD, BRUSHED ANODIZED		
Length: 8.0 feet		Pack: 10 pcs.
h/in.	Part no.	\$/pc.
5/16	ZBL300-42GB-08025	31.40
3/8	ZBL300-42GB-10025	31.81
7/16	ZBL300-42GB-11025	32.27
1/2	ZBL300-42GB-12525	32.94

ALUMINUM 8.0		
SATIN SILVER, BRUSHED ANODIZED		
Length: 8.0 feet		Pack: 10 pcs.
h/in.	Part no.	\$/pc.
5/16	ZBL300-410B-08025	30.19
3/8	ZBL300-410B-10025	30.61
7/16	ZBL300-410B-11025	31.06
1/2	ZBL300-410B-12525	31.69

ALUMINUM 8.0		
TITANIUM BRONZE, BRUSHED ANODIZED		
Length: 8.0 feet		Pack: 10 pcs.
h/in.	Part no.	\$/pc.
5/16	ZBL300-446B-08025	39.18
3/8	ZBL300-446B-10025	39.60
7/16	ZBL300-446B-11025	40.22
1/2	ZBL300-446B-12525	40.72

ALUMINUM 8.0		
ROYAL CHAMPAGNE, BRUSHED ANODIZED		
Length: 8.0 feet		Pack: 10 pcs.
h/in.	Part no.	\$/pc.
5/16	ZBL300-470B-08025	31.40
3/8	ZBL300-470B-10025	31.81
7/16	ZBL300-470B-11025	32.27
1/2	ZBL300-470B-12525	32.94

ALUMINUM 8.0		
STONE GRAY, TEXTURED POWDER-COATED		
Length: 8.0 feet		Pack: 10 pcs.
h/in.	Part no.	\$/pc.
5/16	ZBL300-4591A-08025	34.39
3/8	ZBL300-4591A-10025	34.85
7/16	ZBL300-4591A-11025	35.02
1/2	ZBL300-4591A-12525	36.81

ALUMINUM 8.0		
OXIDE, TEXTURED POWDER-COATED		
Length: 8.0 feet		Pack: 10 pcs.
h/in.	Part no.	\$/pc.
5/16	ZBL300-4581A-08025	34.39
3/8	ZBL300-4581A-10025	34.85
7/16	ZBL300-4581A-11025	35.02
1/2	ZBL300-4581A-12525	36.81

ALUMINUM 8.0		
SAND TROPEZ, TEXTURED POWDER-COATED		
Length: 8.0 feet		Pack: 10 pcs.
h/in.	Part no.	\$/pc.
5/16	ZBL300-4571A-08025	34.39
3/8	ZBL300-4571A-10025	34.85
7/16	ZBL300-4571A-11025	35.02
1/2	ZBL300-4571A-12525	36.81

ALUMINUM 8.0		
GRAPHITE, TEXTURED POWDER-COATED		
Length: 8.0 feet		Pack: 10 pcs.
h/in.	Part no.	\$/pc.
5/16	ZBL300-4561A-08025	34.39
3/8	ZBL300-4561A-10025	34.85
7/16	ZBL300-4561A-11025	35.02
1/2	ZBL300-4561A-12525	36.81

ALUMINUM 8.0		
MATTE BLACK, BRUSHED ANODIZED		
Length: 8.0 feet		Pack: 10 pcs.
h/in.	Part no.	\$/pc.
5/16	ZBL300-416B-08025	39.18
3/8	ZBL300-416B-10025	39.60
7/16	ZBL300-416B-11025	40.22
1/2	ZBL300-416B-12525	40.72

NEW ALUMINUM 8.0		
SUGAR WHITE, TEXTURED POWDER-COATED		
Length: 8.0 feet		Pack: 5 pcs.
h/in.	Part no.	\$/pc.
5/16	ZBL300-4512A-08025	34.39
3/8	ZBL300-4512A-10025	34.85
1/2	ZBL300-4512A-12525	36.81

NEW ALUMINUM 8.0		
QUARTZ, TEXTURED POWDER-COATED		
Length: 8.0 feet		Pack: 5 pcs.
h/in.	Part no.	\$/pc.
5/16	ZBL300-4521A-08025	34.39
3/8	ZBL300-4521A-10025	34.85
1/2	ZBL300-4521A-12525	36.81

NEW ALUMINUM 8.0		
OYSTER WHITE, TEXTURED POWDER-COATED		
Length: 8.0 feet		Pack: 5 pcs.
h/in.	Part no.	\$/pc.
5/16	ZBL300-4511A-08025	34.39
3/8	ZBL300-4511A-10025	34.85
1/2	ZBL300-4511A-12525	36.81

NEW ALUMINUM 8.0		
INDUSTRIAL RUST, TEXTURED POWDER-COATED		
Length: 8.0 feet		Pack: 5 pcs.
h/in.	Part no.	\$/pc.
5/16	ZBL300-4583A-08025	34.39
3/8	ZBL300-4583A-10025	34.85
1/2	ZBL300-4583A-12525	36.81

NEW ALUMINUM 8.0		
COAL BLACK, TEXTURED POWDER-COATED		
Length: 8.0 feet		Pack: 5 pcs.
h/in.	Part no.	\$/pc.
5/16	ZBL300-4562A-08025	34.39
3/8	ZBL300-4562A-10025	34.85
1/2	ZBL300-4562A-12525	36.81

NEW ALUMINUM 8.0		
DARK CHOCOLATE, TEXTURED POWDER-COATED		
Length: 8.0 feet		Pack: 5 pcs.
h/in.	Part no.	\$/pc.
5/16	ZBL300-4582A-08025	34.39
3/8	ZBL300-4582A-10025	34.85
1/2	ZBL300-4582A-12525	36.81

CUBELINE

ALUMINUM 8.0		
SATIN GOLD, BRUSHED ANODIZED		
Length: 8.0 feet		Pack: 5 pcs.
h/in.	Part no.	\$/pc.
3/16	ZBL740-42GB-04525	35.60
5/32	ZBL740-42GB-07025	37.27
1/8	ZBL740-42GB-09025	39.43
7/16	ZBL740-42GB-11025	40.89
1/2	ZBL740-42GB-12525	42.35
5/8	ZBL740-42GB-14025	43.18

ALUMINUM 8.0		
SATIN SILVER, BRUSHED ANODIZED		
Length: 8.0 feet		Pack: 5 pcs.
h/in.	Part no.	\$/pc.
3/16	ZBL740-410B-04525	34.19
5/32	ZBL740-410B-07025	35.85
1/8	ZBL740-410B-09025	38.02
7/16	ZBL740-410B-11025	39.43
1/2	ZBL740-410B-12525	40.93
5/8	ZBL740-410B-14025	41.76

ALUMINUM 8.0		
TITANIUM BRONZE, BRUSHED ANODIZED		
Length: 8.0 feet		Pack: 5 pcs.
h/in.	Part no.	\$/pc.
3/16	ZBL740-446B-04525	41.47
5/32	ZBL740-446B-07025	43.06
1/8	ZBL740-446B-09025	45.05
7/16	ZBL740-446B-11025	46.43
1/2	ZBL740-446B-12525	47.80
5/8	ZBL740-446B-14025	48.55

ALUMINUM 8.0		
ROYAL CHAMPAGNE, BRUSHED ANODIZED		
Length: 8.0 feet		Pack: 5 pcs.
h/in.	Part no.	\$/pc.
3/16	ZBL740-470B-04525	35.60
5/32	ZBL740-470B-07025	37.27
1/8	ZBL740-470B-09025	39.43
7/16	ZBL740-470B-11025	40.89
1/2	ZBL740-470B-12525	42.35
5/8	ZBL740-470B-14025	43.18

ALUMINUM 8.0		
STONE GRAY, TEXTURED POWDER-COATED		
Length: 8.0 feet		Pack: 5 pcs.
h/in.	Part no.	\$/pc.
1/32	ZBL740-4591A-09025	33.73
3/16	ZBL740-4591A-11025	35.39
1/2	ZBL740-4591A-12525	36.23

ALUMINUM 8.0		
OXIDE, TEXTURED POWDER-COATED		
Length: 8.0 feet		Pack: 5 pcs.
h/in.	Part no.	\$/pc.
1/32	ZBL740-4581A-09025	33.73
3/16	ZBL740-4581A-11025	35.39
1/2	ZBL740-4581A-12525	36.23

ALUMINUM 8.0		
SAND TROPEZ, TEXTURED POWDER-COATED		
Length: 8.0 feet		Pack: 5 pcs.
h/in.	Part no.	\$/pc.
1/32	ZBL740-4571A-09025	33.73
3/16	ZBL740-4571A-11025	35.39
1/2	ZBL740-4571A-12525	36.23

ALUMINUM 8.0		
GRAPHITE, TEXTURED POWDER-COATED		
Length: 8.0 feet		Pack: 5 pcs.
h/in.	Part no.	\$/pc.
1/32	ZBL740-4561A-09025	33.73
3/16	ZBL740-4561A-11025	35.39
1/2	ZBL740-4561A-12525	36.23

ALUMINUM 8.0		
MATTE BLACK, BRUSHED ANODIZED		
Length: 8.0 feet		Pack: 5 pcs.
h/in.	Part no.	\$/pc.
3/16	ZBL740-416B-04525	41.47
5/32	ZBL740-416B-07025	43.06
1/8	ZBL740-416B-09025	45.05
7/16	ZBL740-416B-11025	46.43
1/2	ZBL740-416B-12525	47.80
5/8	ZBL740-416B-14025	48.55

ALUMINUM 8.0		
SUGAR WHITE, TEXTURED POWDER-COATED		
Length: 8.0 feet		Pack: 5 pcs.
h/in.	Part no.	\$/pc.
1/32	ZBL740-4512A-09025	33.73
3/16	ZBL740-4512A-11025	35.39
1/2	ZBL740-4512A-12525	36.23

ALUMINUM 8.0		
QUARTZ, TEXTURED POWDER-COATED		
Length: 8.0 feet		Pack: 5 pcs.
h/in.	Part no.	\$/pc.
1/32	ZBL740-4521A-09025	33.73
3/16	ZBL740-4521A-11025	35.39
1/2	ZBL740-4521A-12525	36.23

ALUMINUM 8.0		
OYSTER WHITE, TEXTURED POWDER-COATED		
Length: 8.0 feet		Pack: 5 pcs.
h/in.	Part no.	\$/pc.
1/32	ZBL740-4511A-09025	33.73
3/16	ZBL740-4511A-11025	35.39
1/2	ZBL740-4511A-12525	36.23





ALUMINUM 8.0
INDUSTRIAL RUST, TEXTURED
POWDER-COATED

Length: 8.0 feet Pack: 5 pcs.

h/in.	Part no.	\$/pc.
1/32	ZBL740-4583A-09025	33.73
7/16	ZBL740-4583A-11025	35.39
1/2	ZBL740-4583A-12525	36.23

ALUMINUM 8.0
COAL BLACK, TEXTURED
POWDER-COATED

Length: 8.0 feet Pack: 5 pcs.

h/in.	Part no.	\$/pc.
1/32	ZBL740-4562A-09025	33.73
7/16	ZBL740-4562A-11025	35.39
1/2	ZBL740-4562A-12525	36.23

ALUMINUM 8.0
DARK CHOCOLATE, TEXTURED
POWDER-COATED

Length: 8.0 feet Pack: 5 pcs.

h/in.	Part no.	\$/pc.
1/32	ZBL740-4582A-09025	33.73
7/16	ZBL740-4582A-11025	35.39
1/2	ZBL740-4582A-12525	36.23

CUBELINE, CORNER PIECE (INNER AND OUTER CORNER)

ALUMINUM
SATIN GOLD, BRUSHED ANODIZED

Pack: 1 pc.

h/in.	Part no.	\$/pc.
3/16	ZBL741-42GB-045	17.03
5/32	ZBL741-42GB-070	17.03
11/32	ZBL741-42GB-090	17.03
7/16	ZBL741-42GB-110	17.03
1/2	ZBL741-42GB-125	17.03
17/32	ZBL741-42GB-140	17.03

ALUMINUM
SATIN SILVER, BRUSHED ANODIZED

Pack: 1 pc.

h/in.	Part no.	\$/pc.
3/16	ZBLZBL741-410B-045	17.03
5/32	ZBLZBL741-410B-070	17.03
11/32	ZBLZBL741-410B-090	17.03
7/16	ZBLZBL741-410B-110	17.03
1/2	ZBLZBL741-410B-125	17.03
17/32	ZBLZBL741-410B-140	17.03

ALUMINUM
TITANIUM BRONZE,
BRUSHED ANODIZED

Pack: 1 pc.

h/in.	Part no.	\$/pc.
3/16	ZBL741-446B-045	17.03
5/32	ZBL741-446B-070	17.03
11/32	ZBL741-446B-090	17.03
7/16	ZBL741-446B-110	17.03
1/2	ZBL741-446B-125	17.03
17/32	ZBL741-446B-140	17.03

ALUMINUM
ROYAL CHAMPAGNE,
BRUSHED ANODIZED

Pack: 1 pc.

h/in.	Part no.	\$/pc.
3/16	ZBL741-470B-045	17.03
5/32	ZBL741-470B-070	17.03
11/32	ZBL741-470B-090	17.03
7/16	ZBL741-470B-110	17.03
1/2	ZBL741-470B-125	17.03
17/32	ZBL741-470B-140	17.03

ALUMINUM LOOK
STONE GRAY, TEXTURED
POWDER-COATED

Pack: 1 pc.

h/in.	Part no.	\$/pc.
1/32	ZBL741-9591A-090	5.00
7/16	ZBL741-9591A-110	5.00
1/2	ZBL741-9591A-125	5.00

ALUMINUM LOOK
OXIDE, TEXTURED
POWDER-COATED

Pack: 1 pc.

h/in.	Part no.	\$/pc.
1/32	ZBL741-9581A-090	5.00
7/16	ZBL741-9581A-110	5.00
1/2	ZBL741-9581A-125	5.00

ALUMINUM LOOK
SAND TROPEZ, TEXTURED
POWDER-COATED

Pack: 1 pc.

h/in.	Part no.	\$/pc.
1/32	ZBL741-9571A-090	5.00
7/16	ZBL741-9571A-110	5.00
1/2	ZBL741-9571A-125	5.00

ALUMINUM LOOK
GRAPHITE, TEXTURED
POWDER-COATED

Pack: 1 pc.

h/in.	Part no.	\$/pc.
1/32	ZBL741-9561A-090	5.00
7/16	ZBL741-9561A-110	5.00
1/2	ZBL741-9561A-125	5.00

ALUMINUM
MATTE BLACK, BRUSHED ANODIZED

Pack: 1 pc.

h/in.	Part no.	\$/pc.
3/16	ZBL741-416B-045	17.03
5/32	ZBL741-416B-070	17.03
11/32	ZBL741-416B-090	17.03
7/16	ZBL741-416B-110	17.03
1/2	ZBL741-416B-125	17.03
17/32	ZBL741-416B-140	17.03

ALUMINUM LOOK
SUGAR WHITE, TEXTURED
POWDER-COATED

Pack: 1 pc.

h/in.	Part no.	\$/pc.
1/32	ZBL741-9512A-090	5.00
7/16	ZBL741-9512A-110	5.00
1/2	ZBL741-9512A-125	5.00

ALUMINUM LOOK
QUARTZ, TEXTURED
POWDER-COATED

Pack: 1 pc.

h/in.	Part no.	\$/pc.
1/32	ZBL741-9521A-090	5.00
7/16	ZBL741-9521A-110	5.00
1/2	ZBL741-9521A-125	5.00

ALUMINUM LOOK
OYSTER WHITE, TEXTURED
POWDER-COATED

Pack: 1 pc.

h/in.	Part no.	\$/pc.
1/32	ZBL741-9511A-090	5.00
7/16	ZBL741-9511A-110	5.00
1/2	ZBL741-9511A-125	5.00

ALUMINUM LOOK
INDUSTRIAL RUST, TEXTURED
POWDER-COATED

Pack: 1 pc.

h/in.	Part no.	\$/pc.
1/32	ZBL741-9583A-090	5.00
7/16	ZBL741-9583A-110	5.00
1/2	ZBL741-9583A-125	5.00

ALUMINUM LOOK
COAL BLACK, TEXTURED
POWDER-COATED

Pack: 1 pc.

h/in.	Part no.	\$/pc.
1/32	ZBL741-9562A-090	5.00
7/16	ZBL741-9562A-110	5.00
1/2	ZBL741-9562A-125	5.00

ALUMINUM LOOK
DARK CHOCOLATE, TEXTURED
POWDER-COATED

Pack: 1 pc.

h/in.	Part no.	\$/pc.
1/32	ZBL741-9582A-090	5.00
7/16	ZBL741-9582A-110	5.00
1/2	ZBL741-9582A-125	5.00







LUXURY LINE

LUXURY CLASS TILING ACCESSORIES

LUXURY LINE is a byword for elegance and exclusiveness. With this range of particularly enhanced products, high-class aesthetics that satisfy even the most exacting demands go hand in hand with elegant luxury. The profiles are available in 18 carat rose gold, 24 carat gold as well as black platinum effect to set stylish statements in modern architecture. Thanks to the exclusive nature of these products, they lend individuality to the design of your room and in combination with current trends in tiles, they represent an accomplished symbiosis. With a luxury class of tiling accessories, we are able to fulfill the highest standards of quality.



STAIR PROFILES



42 ANTI-SKID STEP STRIP



45 DECO STAIR NOSE PROFILE



ANTI-SKID STEP STRIP

The ANTI-SKID STEP STRIP is the ideal stair edging for stairways exposed to high traffic and wet conditions. An ANTI-SKID STEP STRIP PVC insert is fitted into an aluminum base to form a durable, safe, and attractive stair nose.

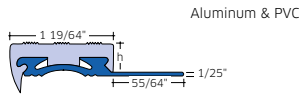

ALUMINUM 8.0			ALUMINUM 4.11			ALUMINUM 8.0		
INCL. PVC INSERT, GRAY			INCL. PVC INSERT, GRAY			INCL. PVC INSERT, BEIGE		
Length: 8.0 feet			Length: 4.11 feet			Length: 8.0 feet		
Pack: 1 pc.			Pack: 1 pc.			Pack: 1 pc.		
h/in.	Part no.	\$/pc.	h/in.	Part no.	\$/pc.	h/in.	Part no.	\$/pc.
1/32	ZBL458-509-09025-1	64.53	1/32	ZBL458-509-0915	35.13	1/32	ZBL458-508S-09025	64.53
7/16	ZBL458-509-11025	66.76	7/16	ZBL458-509-1115	39.02	7/16	ZBL458-508S-11025	66.76

ALUMINUM 4.11			ALUMINUM 8.0			ALUMINUM 4.11		
INCL. PVC INSERT, BEIGE			INCL. PVC INSERT, GRAPHITE BLACK			INCL. PVC INSERT, GRAPHITE BLACK		
Length: 4.11 feet			Length: 8.0 feet			Length: 4.11 feet		
Pack: 1 pc.			Pack: 1 pc.			Pack: 1 pc.		
h/in.	Part no.	\$/pc.	h/in.	Part no.	\$/pc.	h/in.	Part no.	\$/pc.
1/32	ZBL458-508S-0915	35.13	1/32	ZBL458-506-09025	64.53	1/32	ZBL458-506-0915	35.13
7/16	ZBL458-508S-1115	39.02	7/16	ZBL458-506-11025-1	66.76	7/16	ZBL458-506-1115	39.02

ANTI-SKID STEP STRIP (INSERT REPLACEMENT)

PVC 8.0			PVC 8.0			PVC 8.0		
GRAY			BEIGE			GRAPHITE BLACK		
Length: 8.0 feet			Length: 8.0 feet			Length: 8.0 feet		
Pack: 1 pc.			Pack: 1 pc.			Pack: 1 pc.		
h/in.	Part no.	\$/pc.	h/in.	Part no.	\$/pc.	h/in.	Part no.	\$/pc.
1/32	ZBL459-509-09025	23.92	1/32	ZBL459-508S-09025	23.92	1/32	ZBL459-506-09025	23.92
7/16	ZBL459-509-11025	36.72	7/16	ZBL459-508S-11025	36.72	7/16	ZBL459-506-11025	36.72

ANTI-SKID STEP STRIP (SIDE COVER)

PVC			PVC			PVC		
GRAY			BEIGE			GRAPHITE BLACK		
Pack: 2 pcs.			Pack: 2 pcs.			Pack: 2 pcs.		
h/in.	Part no.	\$/pack	h/in.	Part no.	\$/pack	h/in.	Part no.	\$/pack
1/32	ZBL456-509-090	1.78	1/32	ZBL456-508S-090	1.78	1/32	ZBL456-506-090	1.78
7/16	ZBL456-509-110	1.78	7/16	ZBL456-508S-110	1.78	7/16	ZBL456-506-110	1.78

HD ANTI-SKID STEP STRIP

The HD ANTI-SKID STEP STRIP is engineered to provide protection and skid resistance for tiled steps in commercial applications exposed to heavy foot traffic. The HD ANTI-SKID STEP STRIP combines the strength and durability of extruded aluminum at the edge of the step where impact and wear is the severest. The inserts are available in 3 colors and are easily visible at the step edge to alert sight-impaired pedestrians.



ALUMINUM 8.0		
INCL. PVC INSERT, GRAY		
Length: 8.0 feet		Pack: 1 pc.
h/in.	Part no.	\$/pc.
5/16	ZBL441-419-08025	59.86
3/8	ZBL441-419-10025	66.44

ALUMINUM 4.0		
INCL. PVC INSERT, GRAY		
Length: 4.11 feet		Pack: 1 pc.
h/in.	Part no.	\$/pc.
5/16	ZBL441-419-080125	32.92
3/8	ZBL441-419-100125	36.54

ALUMINUM 8.0		
INCL. PVC INSERT, BROWN		
Length: 8.0 feet		Pack: 1 pc.
h/in.	Part no.	\$/pc.
5/16	ZBL441-418-08025	59.86
3/8	ZBL441-418-10025	66.44

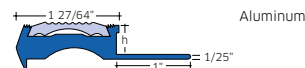

ALUMINUM 4.0		
INCL. PVC INSERT, BROWN		
Length: 4.11 feet		Pack: 1 pc.
h/in.	Part no.	\$/pc.
5/16	ZBL441-418-080125	32.92
3/8	ZBL441-418-100125	36.54

ALUMINUM 8.0		
INCL. PVC INSERT, GRAPHITE BLACK		
Length: 8.0 feet		Pack: 1 pc.
h/in.	Part no.	\$/pc.
5/16	ZBL441-416-08025	59.86
3/8	ZBL441-416-10025	66.44

ALUMINUM 4.0		
INCL. PVC INSERT, GRAPHITE BLACK		
Length: 4.11 feet		Pack: 1 pc.
h/in.	Part no.	\$/pc.
5/16	ZBL441-416-080125	32.92
3/8	ZBL441-416-100125	36.54

ALUMINUM 8.0		
WITHOUT INSERT		
Length: 8.0 feet		Pack: 2 pcs.
h/in.	Part no.	\$/pc.
5/16	ZBL442-410-080	50.63
3/8	ZBL442-410-100	57.08

HD STAIR INSERT (ONLY INSERT)

PVC 8.0		
GRAY		
Length: 8.0 feet		Pack: 1 pc.
Part no.	\$/pc.	
ZBL443-509-1	8.91	

PVC 8.0		
BROWN		
Length: 8.0 feet		Pack: 1 pc.
Part no.	\$/pc.	
ZBL443-508-1	8.91	

PVC 8.0		
GRAPHITE BLACK		
Length: 8.0 feet		Pack: 1 pc.
Part no.	\$/pc.	
ZBL443-506-1	8.91	

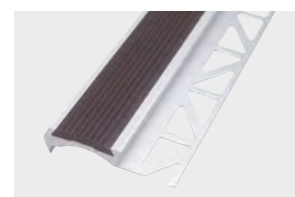

HD STAIR INSERT (SIDE COVER)

METAL		
BLACK, POWDER-COATED		
		Pack: 5 pairs
h/in.	Part no.	\$/pack
5/16, 3/8	ZBL563-166	16.69





CLASSIC STAIR NOSE

The CLASSIC STAIR NOSE is a decorative stair nosing profile specifically to trim stairs and countertop tile installations. This classic shape adds an attractive accent, increases visibility, and provides excellent protection against high impact. Available in chrome-plated brass, stainless steel, and aluminum, the CLASSIC STAIR NOSE is compatible with a wide range of design motifs.

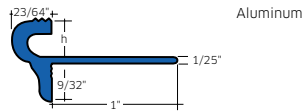
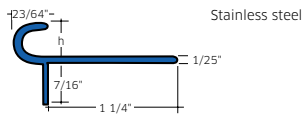
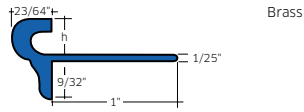

BRASS CHROME-PLATED 8.0

Length: 8.0 feet Pack: 1 pc.

h/in.	Part no.	\$/pc.
1/16	460-340-08025	131.85
3/16	460-340-10025	153.00
1/2	460-340-12525	181.94
13/32	460-340-15025	226.44

BRASS CHROME-PLATED 4.0

Length: 4.0 feet Pack: 1 pc.

h/in.	Part no.	\$/pc.
1/16	460-340-080125	73.83
3/16	460-340-100125	85.68
1/2	460-340-125125	101.88
13/32	460-340-150125	124.55

STAINLESS STEEL NATURAL 8.0

Length: 8.0 feet Pack: 2 pcs.

h/in.	Part no.	\$/pc.
1/32	460-280-09025	109.77
1/16	460-280-11025	116.45

STAINLESS STEEL BRUSHED 8.0

Length: 8.0 feet Pack: 2 pcs.

h/in.	Part no.	\$/pc.
1/32	460-280B-09025	121.79
1/16	460-280B-11025	129.44

ALUMINUM SATIN SILVER, ANODIZED 8.0

Length: 8.0 feet Pack: 2 pcs.

h/in.	Part no.	\$/pc.
1/16	460-410-08025	29.48
3/16	460-410-10025	31.44
1/2	460-410-12525	33.37

ALUMINUM SATIN SILVER, ANODIZED 4.11

Length: 4.11 feet Pack: 2 pcs.

h/in.	Part no.	\$/pc.
1/16	460-410-08015	22.19
3/16	460-410-10015	25.91
1/2	460-410-12515	27.42

ALUMINUM SATIN SILVER, ANODIZED 4.0

Length: 4.0 feet Pack: 2 pcs.

h/in.	Part no.	\$/pc.
1/16	460-410-080125	16.39
3/16	460-410-100125	17.45
1/2	460-410-125125	18.55

DECO STAIR NOSE PROFILE

The DECO STAIR NOSE PROFILE combines decorative, contemporary design with the strength and beauty of stainless steel. This trim accents and protects stair edges and countertops for increased durability and visibility.



STAINLESS STEEL 8.0 BRUSHED

Length: 8.0 feet Pack: 2 pcs.

h/in.	Part no.	\$/pc.
5/16	462-280-8025	70.77
3/8	462-280-1025	77.56
1/2	462-280-12525	81.78

STAINLESS STEEL 4.0 BRUSHED

Length: 4.0 feet Pack: 2 pcs.

h/in.	Part no.	\$/pc.
5/16	462-280-8125	37.51
3/8	462-280-1125	41.11
1/2	462-280-125125	43.35

STAINLESS STEEL 8.0 POLISHED

Length: 8.0 feet Pack: 2 pcs.

h/in.	Part no.	\$/pc.
5/16	462-286-8025	89.24
3/8	462-286-1025	96.02
1/2	462-286-12525	104.59

STAINLESS STEEL 4.0 POLISHED

Length: 4.0 feet Pack: 2 pcs.

h/in.	Part no.	\$/pc.
5/16	462-286-8125	47.29
3/8	462-286-1125	50.88
1/2	462-286-125125	55.43

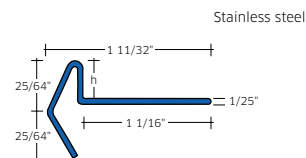



STEPLINE

STEPLINE is a high-quality profile made for protecting stair edges. The anti-slip tread is integrated into the stainless steel surface for increased safety and durability. STEPLINE can be used on step treads in combination with ceramics and natural stone fixed according to the thin bed method. This profile is especially effective in commercial applications and high traffic areas.



STAINLESS STEEL 8.0 NATURAL

Length: 8.0 feet Pack: 1 pc.

h/in.	Part no.	\$/pc.
1/32	ZBL841-280-090250	67.47
7/16	ZBL841-280-110250	68.21
17/32	ZBL841-280-135250	69.15

STAINLESS STEEL 4.11 NATURAL

Length: 4.11 feet Pack: 1 pc.

h/in.	Part no.	\$/pc.
1/32	ZBL841-280-090150	44.52
7/16	ZBL841-280-110150	45.05
17/32	ZBL841-280-135150	45.89

STAINLESS STEEL 4.0 NATURAL

Length: 4.0 feet Pack: 1 pc.

h/in.	Part no.	\$/pc.
1/32	ZBL841-280-090125	37.10
7/16	ZBL841-280-110125-1	37.52
17/32	ZBL841-280-135125	38.05

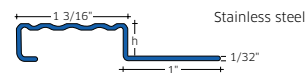

STEPLINE, COVER CAP

STAINLESS STEEL NATURAL

Pack: 1 pc.

h/in.	Part no.	\$/pc.
1/32 / 7/16 / 17/32	ZBL842-280	5.35

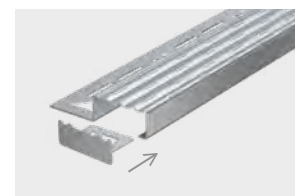



TRANSITION & RENOVATION PROFILES



50 ADJUSTABLE TRANSITION
PROFILE



51 DRIVE

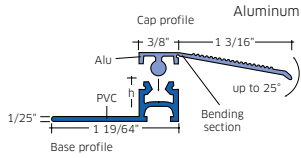

ADJUSTABLE TRANSITION PROFILE

Due to an innovative design, the ADJUSTABLE TRANSITION PROFILE can be used for transition from ceramic tile to any floor surface with a height difference of up to 1/2". The ADJUSTABLE TRANSITION PROFILE is comprised of a rigid PVC base which is color coded to designate the corresponding tile height, and an aluminum cap profile which is inserted into the base after the adjoining floor surface has been installed. The aluminum transition arm is then pressed down to rest on the adjacent floor surface.

ALUMINUM 8.0

SATIN SILVER, ANODIZED

Length: 8.0 feet Pack: 1 pc.

h/in.	Part no.	\$/pc.
1/4	ZBL423-980-060-1	42.18
3/16	ZBL423-980-080	42.94
3/8	ZBL423-980-100-1	43.85
1/2	ZBL423-980-125	44.73

ALUMINUM 4.0

SATIN SILVER, ANODIZED

Length: 4.0 feet Pack: 1 pc.

h/in.	Part no.	\$/pc.
1/4	ZBL423-980-060125	30.40
3/16	ZBL423-980-080125	30.88
3/8	ZBL423-980-100125	31.40
1/2	ZBL423-980-125125	32.13

ALUMINUM 8.0

BRONZE, ANODIZED

Length: 8.0 feet Pack: 1 pc.

h/in.	Part no.	\$/pc.
1/4	ZBL423-950-060	54.76
3/16	ZBL423-950-080	56.19
3/8	ZBL423-950-100-1	57.30
1/2	ZBL423-950-125-1	58.19

ALUMINUM 4.0

BRONZE, ANODIZED

Length: 4.0 feet Pack: 1 pc.

h/in.	Part no.	\$/pc.
1/4	ZBL423-950-060125	34.68
3/16	ZBL423-950-080125	35.32
3/8	ZBL423-950-100125-1	35.97
1/2	ZBL423-950-125125	36.53



SELF-ADHESIVE TRANSITION PROFILE

The SELF-ADHESIVE TRANSITION PROFILE is easy to apply and adheres to many different surface types including ceramic, wood, vinyl and commercial grade carpet. Because the SELF-ADHESIVE TRANSITION PROFILE goes in after both adjoining surfaces are installed, it is ideal for renovations where the ceramic tile is already in place.

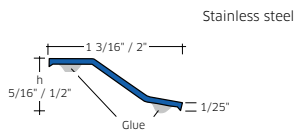

STAINLESS STEEL 8.8

NATURAL

Length: 8.8 feet Pack: 10 pcs.

w/in.	Part no.	\$/pc.
1 3/16	ZBL434-280-030	52.30
2	ZBL434-280-050	71.21

T-TRANSITION PROFILE (JOINT COVER)

The T-TRANSITION PROFILE is available in aluminum, brass, chrome-plated brass, or stainless steel for attractive, decorative transitions.



BRASS NATURAL		
Length: 8.0 feet		Pack: 1 pc.
w/in.	Part no.	\$/pc.
1/32	ZBL449-300-1425	18.36
1/8	ZBL449-300-2025	31.16

BRASS CHROME-PLATED		
Length: 8.0 feet		Pack: 1 pc.
w/in.	Part no.	\$/pc.
1/32	ZBL449-340-1425	45.62
1/8	ZBL449-340-2025	52.85

STAINLESS STEEL BRUSHED		
Length: 8.0 feet		Pack: 1 pc.
w/in.	Part no.	\$/pc.
1/32	ZBL449-280B-1425	34.14
1	ZBL449-280B-2525	38.93

ALUMINUM NATURAL		
Length: 8.0 feet		Pack: 1 pc.
w/in.	Part no.	\$/pc.
1/32	ZBL449-400-1425	6.23
1/8	ZBL449-400-2025-1	7.57

ALUMINUM SATIN SILVER, ANODIZED		
Length: 8.0 feet		Pack: 1 pc.
w/in.	Part no.	\$/pc.
1/32	ZBL449-410-1425	9.80
1/8	ZBL449-410-2025	13.06

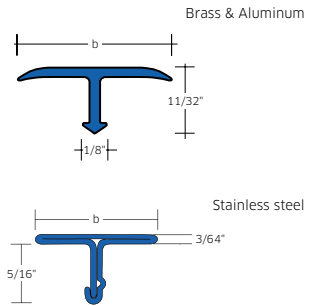

DRIVE

DRIVE is a transition and renovation profile for transitions exposed to small wheel and roll-on traffic. Ideal for connections from tile to concrete or PVC floorings that require a gradual slope to reduce mechanical stress and eliminate trip hazards.



ALUMINUM SATIN SILVER, ANODIZED		
Length: 8.0 feet		Pack: 1 pc.
w/in.	Part no.	\$/pc.
3/8	ZBL580-410-10025-1	40.17
1/2	ZBL580-410-12525-1	41.89
19/32	ZBL580-410-15025-1	52.03

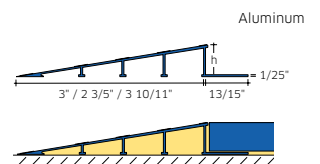

Important note:
This profile is ADA compliant.



REDUCER TRIM

The REDUCER TRIM is designed to transition from ceramic tile and stone to flooring at lower elevations. The REDUCER TRIM provides a gradual slope to eliminate trip hazards and is available in brass, stainless steel and aluminum finishes. The REDUCER TRIM is appropriate for a wide range of applications from residential to heavy-load commercial.

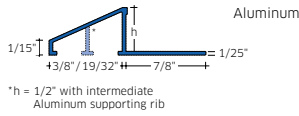
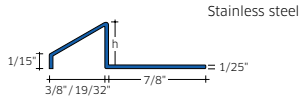

STAINLESS STEEL 8.0		
BRUSHED		
Length: 8.0 feet		Pack: 5 pcs.
h/in.	Part no.	\$/pc.
1/32	ZBL217-280B-09025	60.63
7/16	ZBL217-280B-11025	70.15
1/2	ZBL217-280B-12525	73.62

ALUMINUM 8.0		
SATIN SILVER, ANODIZED		
Length: 8.0 feet		Pack: 5 pcs.
h/in.	Part no.	\$/pc.
1/16	ZBL217-410-08025-1	15.73
3/16	ZBL217-410-10025	16.91
1/2	ZBL217-410-12525	22.58

ALUMINUM 8.0		
TITANIUM BRONZE, ANODIZED		
Length: 8.0 feet		Pack: 5 pcs.
h/in.	Part no.	\$/pc.
1/16	ZBL217-446-08025	19.46
3/16	ZBL217-446-10025	20.78
1/2	ZBL217-446-12525	21.42

ALUMINUM 8.0		
ROYAL CHAMPAGNE, ANODIZED		
Length: 8.0 feet		Pack: 5 pcs.
h/in.	Part no.	\$/pc.
1/16	ZBL217-470-08025	19.46
3/16	ZBL217-470-10025	20.78
1/2	ZBL217-470-12525	21.42



CARPET TRIM

The CARPET TRIM is an ideal transition from hard tile to lower flooring, especially carpet. The sloped nose of the profile covers the edge of the carpet to prevent carpet fraying while protecting the tile edge. The CARPET TRIM is available in aluminum, brass and stainless steel with strength suitable for both residential and commercial applications.

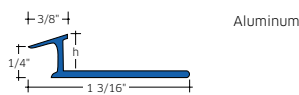
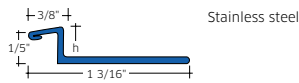

STAINLESS STEEL 8.0		
BRUSHED		
Length: 8.0 feet		Pack: 5 pcs.
h/in.	Part no.	\$/pc.
1/16	ZBL4831-280-08025	94.50
3/16	ZBL4831-280-10025	100.01

ALUMINUM 8.0		
SATIN SILVER, ANODIZED		
Length: 8.0 feet		Pack: 5 pcs.
h/in.	Part no.	\$/pc.
1/16	ZBL218-410-08025-1	14.24
3/16	ZBL218-410-10025-1	16.24
1/2	ZBL218-410-12525-1	19.10

ALUMINUM 8.0		
TITANIUM BRONZE, ANODIZED		
Length: 8.0 feet		Pack: 5 pcs.
h/in.	Part no.	\$/pc.
1/16	ZBL218-446-08025	19.23
3/16	ZBL218-446-10025	20.09
1/2	ZBL218-446-12525	20.73

ALUMINUM 8.0		
ROYAL CHAMPAGNE, ANODIZED		
Length: 8.0 feet		Pack: 5 pcs.
h/in.	Part no.	\$/pc.
1/16	ZBL218-470-08025	19.23
3/16	ZBL218-470-10025	20.09
1/2	ZBL218-470-12525	20.73

SKIRTING

The SKIRTING is an anodized aluminum cove profile that is designed to provide attractive interior wall protection. The aluminum profile is available in two different finishes with inner and outer corners for both sizes.

ALUMINUM		
SATIN SILVER, ANODIZED		
Length: 8.0 feet		Pack: 1 pc.
h/in.	Part no.	\$/pc.
2 ³ / ₈	ZBL221-410-060	59.78

ALUMINUM		
WHITE, POWDER-COATED		
Length: 8.0 feet		Pack: 1 pc.
h/in.	Part no.	\$/pc.
2 ³ / ₈	ZBL221-450-060	95.99

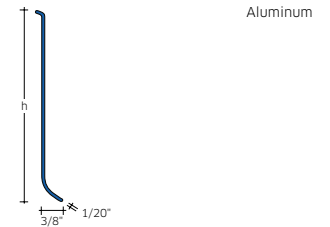

SKIRTING, INNER CORNERS, OUTER DIMENSION 1 3/16"

ALUMINUM		
SATIN SILVER, ANODIZED		
Pack: 2 pcs.		
h/in.	Part no.	\$/pc.
2 ³ / ₈	ZBL222-410-060	39.79

ALUMINUM		
WHITE, POWDER-COATED		
Pack: 2 pcs.		
h/in.	Part no.	\$/pc.
2 ³ / ₈	ZBL222-450-060	50.73



SKIRTING, OUTER CORNERS, OUTER DIMENSION 1 3/16"

ALUMINUM		
SATIN SILVER, ANODIZED		
Pack: 2 pcs.		
h/in.	Part no.	\$/pc.
2 ³ / ₈	ZBL223-410-060	39.79

ALUMINUM		
WHITE, POWDER-COATED		
Pack: 2 pcs.		
h/in.	Part no.	\$/pc.
2 ³ / ₈	ZBL223-450-060	50.73





COVE

The stainless steel and new aluminum cove profile COVE is designed to solve transition problems between inside wall-to-floor tiled corners. The cove-shaped profile makes cleaning simple, repels water, and provides an attractive and smooth finish between 90° tiled surfaces. Perfect for commercial and residential installations, COVE is constructed with high-grade anodized aluminum and stainless steel.

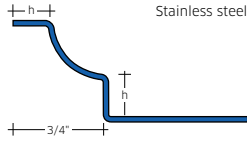

STAINLESS STEEL 8.0 NATURAL

Length: 8.0 feet Pack: 1 pc.

h/in.	Part no.	\$/pc.
1/2	ZBL424-280-12525	75.56

STAINLESS STEEL 8.0 BRUSHED

Length: 8.0 feet Pack: 1 pc.

h/in.	Part no.	\$/pc.
1/2	ZBL424-280B-12525	85.88

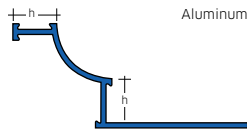

NEW ALUMINUM 8.0 SATIN SILVER, ANODIZED

Length: 8.0 feet Pack: 1 pc.

h/in.	Part no.	\$/pc.
5/16	ZBL424-410-08025	19.92
3/8	ZBL424-410-10025	20.45
1/2	ZBL424-410-12525	20.85

NEW ALUMINUM 8.0 BRUSHED NICKEL, ANODIZED

Length: 8.0 feet Pack: 1 pc.

h/in.	Part no.	\$/pc.
5/16	ZBL424-420B-08025	38.90
3/8	ZBL424-420B-10025	39.25
1/2	ZBL424-420B-12525	39.98

NEW ALUMINUM 8.0 TITANIUM BRONZE

Length: 8.0 feet Pack: 5 pcs.

h/in.	Part no.	\$/pc.
5/16	ZBL424-446-08025	22.91
3/8	ZBL424-446-10025	23.52
1/2	ZBL424-446-12525	23.98

COVE INNER CORNER



Important note:

One size of the COVE outside/inside corners and end caps fits all COVE profiles.

STAINLESS STEEL NATURAL

Pack: 2 pcs.

h/in.	Part no.	\$/pc.
1/2	ZBL426-280-125	7.29

STAINLESS STEEL BRUSHED

Pack: 2 pcs.

h/in.	Part no.	\$/pc.
1/2	ZBL426-280B-125	9.47

NEW ALUMINUM SATIN SILVER, ANODIZED

Pack: 2 pcs.

h/in.	Part no.	\$/pc.
1/2	ZBL426-410	7.90

NEW ALUMINUM BRUSHED NICKEL

Pack: 2 pcs.

h/in.	Part no.	\$/pc.
1/2	ZBL426-420B	9.95

NEW ALUMINUM TITANIUM BRONZE

Pack: 2 pcs.

h/in.	Part no.	\$/pc.
1/2	ZBL426-446	7.90

COVE OUTER CORNER

STAINLESS STEEL
NATURAL

Pack: 2 pcs.

h/in.	Part no.	\$/pc.
½	ZBL425-280-125	7.29

STAINLESS STEEL
BRUSHED

Pack: 2 pcs.

h/in.	Part no.	\$/pc.
½	ZBL425-280B-125	9.47

NEW
ALUMINUM
SATIN SILVER, ANODIZED

Pack: 2 pcs.

h/in.	Part no.	\$/pc.
½	ZBL425-410	7.90

NEW
ALUMINUM
BRUSHED NICKEL

Pack: 2 pcs.

h/in.	Part no.	\$/pc.
½	ZBL425-420B	9.95

NEW
ALUMINUM
TITANIUM BRONZE

Pack: 2 pcs.

h/in.	Part no.	\$/pc.
½	ZBL425-446	7.90



Important note:

One size of the COVE outside/inside corners and end caps fits all COVE profiles.

COVE END CAP

NEW
ALUMINUM
SATIN SILVER, ANODIZED

Pack: 2 pcs.

h/in.	Part no.	\$/pc.
½	ZBL427-410	29.83

NEW
ALUMINUM
BRUSHED NICKEL

Pack: 2 pcs.

h/in.	Part no.	\$/pc.
½	ZBL427-420B	29.83

NEW
ALUMINUM
TITANIUM BRONZE

Pack: 2 pcs.

h/in.	Part no.	\$/pc.
½	ZBL427-446	29.83



Important note:

One size of the COVE outside/inside corners and end caps fits all COVE profiles.



EXPANSION JOINTS & SCREED ACCESSORIES



59 HEAVY DUTY
EXPANSION JOINT



60 V-SCREED
EXPANSION JOINT



FLOOREX

FLOOREX is an expansion joint that provides tile edge protection while absorbing movement. The vertical legs of the FLOOREX consist of a durable hard PVC while the upper and lower expansion zones are made with low-gloss PVC in colors that match grout joints for coordinated installations.

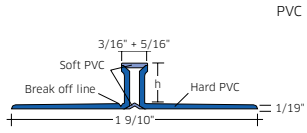

PVC

PVC **8.0**
LIGHT GRAY

Joint width: $\frac{3}{16}$ inch
 Length: 8.0 feet Pack: 1 pc.

h/in.	Part no.	\$/pc.
$\frac{1}{32}$	ZBL315-509-09025	15.57
$\frac{1}{16}$	ZBL315-509-11025	16.36
$\frac{1}{2}$	ZBL315-509-12525	17.18

PVC **8.0**
MEDIUM GRAY

Joint width: $\frac{3}{16}$ inch
 Length: 8.0 feet Pack: 1 pc.

h/in.	Part no.	\$/pc.
$\frac{1}{32}$	ZBL315-5095-09025	15.57
$\frac{1}{16}$	ZBL315-5095-11025	16.36
$\frac{1}{2}$	ZBL315-5095-12525	17.18

PVC **8.0**
SAND GRAY

Joint width: $\frac{3}{16}$ inch
 Length: 8.0 feet Pack: 1 pc.

h/in.	Part no.	\$/pc.
$\frac{1}{32}$	ZBL315-5093-09025	15.57
$\frac{1}{16}$	ZBL315-5093-11025	16.36
$\frac{1}{2}$	ZBL315-5093-12525	17.18

PVC **8.0**
ANTHRACITE

Joint width: $\frac{3}{16}$ inch
 Length: 8.0 feet Pack: 1 pc.

h/in.	Part no.	\$/pc.
$\frac{1}{32}$	ZBL315-5099-09025-1	15.57
$\frac{1}{16}$	ZBL315-5099-11025	16.36
$\frac{1}{2}$	ZBL315-5099-12525	17.18

PVC **8.0**
BAHAMA BEIGE

Joint width: $\frac{3}{16}$ inch
 Length: 8.0 feet Pack: 1 pc.

h/in.	Part no.	\$/pc.
$\frac{1}{32}$	ZBL315-5071-09025	15.57
$\frac{1}{16}$	ZBL315-5071-11025	16.36
$\frac{1}{2}$	ZBL315-5071-12525	17.18

HEAVY DUTY EXPANSION JOINT

The HEAVY DUTY EXPANSION JOINT is constructed with aluminum or stainless steel edges and is filled with a colored silicone. This silicone movement zone is available in multiple colors to coordinate with grout color and helps to absorb movement caused by shrinkage, structure settling, substrate expansion and contraction, and vibration.



STAINLESS STEEL 8.0 GRAY SILICONE		
Length: 8.0 feet		Pack: 1 pc.
h/in.	Part no.	\$/pc.
1/4	ZBL355-280-06025	83.31
3/16	ZBL355-280-08025	89.58
3/8	ZBL355-280-10025	94.57
1/2	ZBL355-280-12525	100.14
5/8	ZBL355-280-15025	106.82
3/4	ZBL355-280-18525	109.14
7/8	ZBL355-280-22025	111.26
1	ZBL355-280-25025	120.17
1 3/16	ZBL355-280-30025	122.40

STAINLESS STEEL 8.0 GRANITE GRAY SILICONE		
Length: 8.0 feet		Pack: 1 pc.
h/in.	Part no.	\$/pc.
1/4	ZBL355-2894-06025	83.31
3/16	ZBL355-2894-08025	89.58
3/8	ZBL355-2894-10025	94.57
1/2	ZBL355-2894-12525	100.14
5/8	ZBL355-2894-15025	106.82
3/4	ZBL355-2894-18525	109.14
7/8	ZBL355-2894-22025	111.26
1	ZBL355-2894-25025	120.17
1 3/16	ZBL355-2894-30025	122.40

STAINLESS STEEL 8.0 BLACK SILICONE		
Length: 8.0 feet		Pack: 1 pc.
h/in.	Part no.	\$/pc.
1/4	ZBL355-286-06025	83.31
3/16	ZBL355-286-08025	89.58
3/8	ZBL355-286-10025	94.57
1/2	ZBL355-286-12525	100.14
5/8	ZBL355-286-15025	106.82
3/4	ZBL355-286-18525	109.14
7/8	ZBL355-286-22025	111.26
1	ZBL355-286-25025	120.17
1 3/16	ZBL355-286-30025	122.40

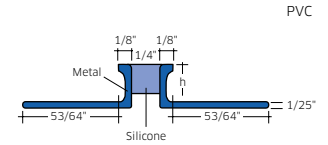

ALUMINUM 8.0 GRAY SILICONE		
Length: 8.0 feet		Pack: 1 pc.
h/in.	Part no.	\$/pc.
1/4	ZBL355-409-06025	33.74
3/16	ZBL355-409-08025	36.27
3/8	ZBL355-409-10025	37.93
1/2	ZBL355-409-12525	39.61
5/8	ZBL355-409-15025	41.62
3/4	ZBL355-409-18525	42.39
7/8	ZBL355-409-22025	43.95
1	ZBL355-409-25025	44.61
1 3/16	ZBL355-409-30025	45.75

ALUMINUM 8.0 GRANITE GRAY SILICONE		
Length: 8.0 feet		Pack: 1 pc.
h/in.	Part no.	\$/pc.
1/4	ZBL355-4094-06025	33.74
3/16	ZBL355-4094-08025	36.27
3/8	ZBL355-4094-10025	37.93
1/2	ZBL355-4094-12525	39.61
5/8	ZBL355-4094-15025	41.62
3/4	ZBL355-4094-18525	42.39
7/8	ZBL355-4094-22025	43.95
1	ZBL355-4094-25025	44.61
1 3/16	ZBL355-4094-30025	45.75

ALUMINUM 8.0 BLACK SILICONE		
Length: 8.0 feet		Pack: 1 pc.
h/in.	Part no.	\$/pc.
1/4	ZBL355-406-06025	33.74
3/16	ZBL355-406-08025	36.27
3/8	ZBL355-406-10025	37.93
1/2	ZBL355-406-12525	39.61
5/8	ZBL355-406-15025	41.62
3/4	ZBL355-406-18525	42.39
7/8	ZBL355-406-22025	43.95
1	ZBL355-406-25025	44.61
1 3/16	ZBL355-406-30025	45.75

Advantages:

- > Expansion joint for ceramic tiles
- > Specially developed to absorb heavy traffic loads
- > Optimal suitability for industrial use
- > Excellent resistance to grease, oil and cleaning chemicals
- > Available in aluminum or stainless steel

Important note:

Heavy Duty Expansion Joints are made to order. Lead times and freight charges will vary depending on the item and quantity ordered. Please contact your sales representative for details regarding variables when ordering this product.

SILICONE COLORS





SCREED EXPANSION JOINT

The SCREED EXPANSION JOINT is a profile manufactured with hard and soft coextruded PVC. This profile protects tile edges and absorbs any movement from expansion and contraction in medium to thick slabs. The SCREED EXPANSION JOINT is used with screeds where there may be compression, shear, and tensile strengths. The soft PVC between the two hard PVC sides forms the expansion zone.

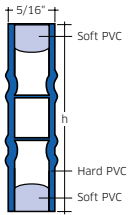

PVC

PVC **8.0**
GRAY

Length: 8.0 feet Pack: 10 pcs.

h/in.	Part no.	\$/pc.
1 3/16	ZBL392-509-03025	15.57
1 3/8	ZBL392-509-04025	19.48
2	ZBL392-509-05025	32.27
2 3/8	ZBL392-509-06025	35.38



V-SCREED EXPANSION JOINT

The V-SCREED EXPANSION JOINT is a profile made of hard and soft coextruded PVC and is used where movement joints are needed in tiles, bricks, or pavers installed in a thick mortar bed. The V-SCREED EXPANSION Joint absorbs stresses caused by system movements and the hard PVC edges protect the tile edges from wear and tear. These movement joints can also be pounded into a sawcut after installation (i.e. when renovating older buildings).

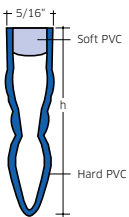

PVC

PVC **8.0**
GRAY

Length: 8.0 feet Pack: 10 pcs.

h/in.	Part no.	\$/pc.
1 3/16	ZBL584-509-03025	10.80
1 3/8	ZBL584-509-04025	13.13
2	ZBL584-509-05025	21.59
2 3/8	ZBL584-509-06025	35.16





AQUA PROFILES



64 AQUA-KEIL

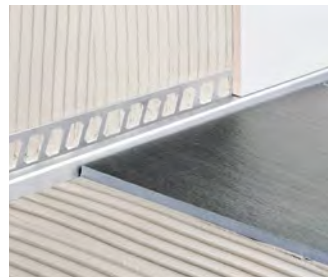

66 AQUA-KEIL WALL



68 AQUA-GLASS



AQUA-KEIL

AQUA-KEIL is the perfect solution for transition from a sloped tiled shower floor to a level adjacent floor where a glass partition or wall is needed. It is particularly useful for showers with a constant pitch down to a linear drain. Left and right versions are available.

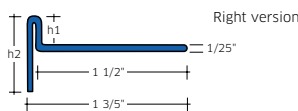
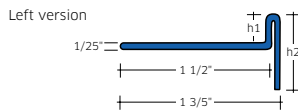

Advantages:

- > Easy to install; profile is pre-sloped (2%)
- > Eliminates odd angled cuts of wall tile at base of shower wall
- > Facilitates cleaning and shower maintenance
- > Provides a sleek seamless contemporary finish to wall/floor connections

Attention:

It is very important that the AQUA-KEIL does not damage the waterproofing material. Different slopes can be created by using different heights of tiles. (Image 1)

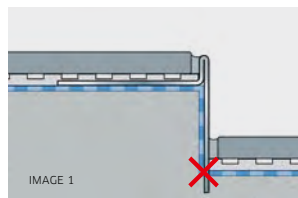

LEFT VERSION STAINLESS STEEL, BRUSHED

6.7

Length: 6.7 feet Pack: 1 pc.

h1/in.	h2/in.	Part no.	\$/pc.
3/8	1 3/8	ZBL844-280B-100-L	308.44
7/16	1 3/8	ZBL844-280B-110-L	309.72
1/2	1 3/8	ZBL844-280B-125-L	311.72

RIGHT VERSION STAINLESS STEEL, BRUSHED

6.7

Length: 6.7 feet Pack: 1 pc.

h1/in.	h2/in.	Part no.	\$/pc.
3/8	1 3/8	ZBL844-280B-100-R	308.44
7/16	1 3/8	ZBL844-280B-110-R	309.72
1/2	1 3/8	ZBL844-280B-125-R	311.72

LEFT VERSION STAINLESS STEEL, BRUSHED

4.10

Length: 4.10 feet Pack: 1 pc.

h1/in.	h2/in.	Part no.	\$/pc.
5/16	1 1/2	ZBL755-280B-080-L	185.47
3/8	1 1/2	ZBL755-280B-100-L	186.92
7/16	1 1/2	ZBL755-280B-110-L	188.09
1/2	1 1/2	ZBL755-280B-125-L	188.39

RIGHT VERSION STAINLESS STEEL, BRUSHED

4.10

Length: 4.10 feet Pack: 1 pc.

h1/in.	h2/in.	Part no.	\$/pc.
5/16	1 1/2	ZBL755-280B-080-R	185.47
3/8	1 1/2	ZBL755-280B-100-R	186.92
7/16	1 1/2	ZBL755-280B-110-R	188.09
1/2	1 1/2	ZBL755-280B-125-R	188.39

LEFT VERSION STAINLESS STEEL, BRUSHED

3.215

Length: 3.215 feet Pack: 1 pc.

h1/in.	h2/in.	Part no.	\$/pc.
5/16	1 5/16	ZBL754-280B-080-L	118.81
3/8	1 5/16	ZBL754-280B-100-L	120.28
7/16	1 5/16	ZBL754-280B-110-L	121.02
1/2	1 5/16	ZBL754-280B-125-L	121.72

RIGHT VERSION STAINLESS STEEL, BRUSHED

3.215

Length: 3.215 feet Pack: 1 pc.

h1/in.	h2/in.	Part no.	\$/pc.
5/16	1 5/16	ZBL754-280B-080-R	118.81
3/8	1 5/16	ZBL754-280B-100-R	120.28
7/16	1 5/16	ZBL754-280B-110-R	121.02
1/2	1 5/16	ZBL754-280B-125-R	121.72

LEFT VERSION STAINLESS STEEL, CHROME-PLATED

6.7

Length: 6.7 feet Pack: 1 pc.

h1/in.	h2/in.	Part no.	\$/pc.
3/8	1 3/8	ZBL844-2840-100-L	364.68
7/16	1 3/8	ZBL844-2840-110-L	366.73
1/2	1 3/8	ZBL844-2840-125-L	368.78

RIGHT VERSION STAINLESS STEEL, CHROME-PLATED

6.7

Length: 6.7 feet Pack: 1 pc.

h1/in.	h2/in.	Part no.	\$/pc.
3/8	1 3/8	ZBL844-2840-100-R	364.68
7/16	1 3/8	ZBL844-2840-110-R	366.73
1/2	1 3/8	ZBL844-2840-125-R	368.78



Cabin™ | Zion

LEFT VERSION

STAINLESS STEEL, CHROME-PLATED

4.10

Length: 4.10 feet

Pack: 1 pc.

h1/in.	h2/in.	Part no.	\$/pc.
5/16	1 1/32	ZBL755-2840-080-L	221.72
3/8	1 1/32	ZBL755-2840-100-L	223.77
7/16	1 1/32	ZBL755-2840-110-L	225.21
1/2	1 1/32	ZBL755-2840-125-L	226.85

RIGHT VERSION

STAINLESS STEEL, CHROME-PLATED

4.10

Length: 4.10 feet

Pack: 1 pc.

h1/in.	h2/in.	Part no.	\$/pc.
5/16	1 1/32	ZBL755-2840-080-R	221.72
3/8	1 1/32	ZBL755-2840-100-R	223.77
7/16	1 1/32	ZBL755-2840-110-R	225.21
1/2	1 1/32	ZBL755-2840-125-R	226.85

LEFT VERSION

STAINLESS STEEL, CHROME-PLATED

3.215

Length: 3.215 feet

Pack: 1 pc.

h1/in.	h2/in.	Part no.	\$/pc.
5/16	1 1/16	ZBL754-2840-080-L	139.88
3/8	1 1/16	ZBL754-2840-100-L	142.35
7/16	1 1/16	ZBL754-2840-110-L	143.37
1/2	1 1/16	ZBL754-2840-125-L	144.40

RIGHT VERSION

STAINLESS STEEL, CHROME-PLATED

3.215

Length: 3.215 feet

Pack: 1 pc.

h1/in.	h2/in.	Part no.	\$/pc.
5/16	1 1/16	ZBL754-2840-080-R	139.88
3/8	1 1/16	ZBL754-2840-100-R	142.35
7/16	1 1/16	ZBL754-2840-110-R	143.37
1/2	1 1/16	ZBL754-2840-125-R	144.40

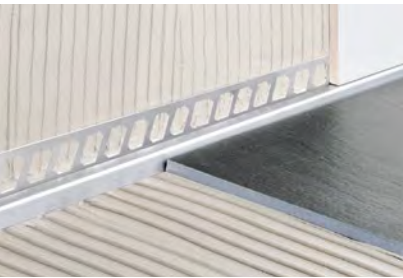

AQUA-KEIL WALL

AQUA-KEIL WALL, the sloped (2%) edge profile constructed from easy to maintain stainless steel, provides the perfect solution to connect straight cut tiled shower walls to sloped shower floors where linear drains are installed.

Left version

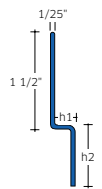

Right version

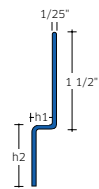

LEFT VERSION

STAINLESS STEEL, BRUSHED

Length: 6.7 feet

6.7

Pack: 1 pc.

h1/in.	h2/in.	Part no.	\$/pc.
3/16	1 3/8	840-280B-080-L	237.54
3/8	1 3/8	840-280B-100-L	242.58
7/16	1 3/8	840-280B-110-L	245.31
1/2	1 3/8	840-280B-125-L	247.64

RIGHT VERSION

STAINLESS STEEL, BRUSHED

Length: 6.7 feet

6.7

Pack: 1 pc.

h1/in.	h2/in.	Part no.	\$/pc.
3/16	1 3/8	840-280B-080-R	237.54
3/8	1 3/8	840-280B-100-R	242.58
7/16	1 3/8	840-280B-110-R	245.31
1/2	1 3/8	840-280B-125-R	247.64

Advantages:

- > Easy to install - slope of 2% included
- > Other slopes can be realized by using different heights of tiles
- > Oblique cuts of tiles are not necessary
- > Versions for left and right transition are available

LEFT VERSION

STAINLESS STEEL, BRUSHED

Length: 4.10 feet

4.10

Pack: 1 pc.

h1/in.	h2/in.	Part no.	\$/pc.
3/16	1 1/2	846-280B-080-L	185.47
3/8	1 1/2	846-280B-100-L	186.92
7/16	1 1/2	846-280B-110-L	187.47
1/2	1 1/2	846-280B-125-L	188.39

RIGHT VERSION

STAINLESS STEEL, BRUSHED

Length: 4.10 feet

4.10

Pack: 1 pc.

h1/in.	h2/in.	Part no.	\$/pc.
3/16	1 1/2	846-280B-080-R	185.47
3/8	1 1/2	846-280B-100-R	186.92
7/16	1 1/2	846-280B-110-R	187.47
1/2	1 1/2	846-280B-125-R	188.39



LEFT VERSION**3.215**

STAINLESS STEEL, BRUSHED

Length: 3.215 feet

Pack: 1 pc.

h1/in.	h2/in.	Part no.	\$/pc.
$\frac{3}{16}$	$\frac{1}{16}$	845-280B-080-L	118.81
$\frac{3}{8}$	$\frac{1}{16}$	845-280B-100-L	120.28
$\frac{7}{16}$	$\frac{1}{16}$	845-280B-110-L	121.02
$\frac{1}{2}$	$\frac{1}{16}$	845-280B-125-L	121.72

RIGHT VERSION**3.215**

STAINLESS STEEL, BRUSHED

Length: 3.215 feet

Pack: 1 pc.

h1/in.	h2/in.	Part no.	\$/pc.
$\frac{3}{16}$	$\frac{1}{16}$	845-280B-080-R	118.81
$\frac{3}{8}$	$\frac{1}{16}$	845-280B-100-R	120.28
$\frac{7}{16}$	$\frac{1}{16}$	845-280B-110-R	121.02
$\frac{1}{2}$	$\frac{1}{16}$	845-280B-125-R	121.72

LEFT VERSION**6.7**

STAINLESS STEEL, CHROME-PLATED

Length: 6.7 feet

Pack: 1 pc.

h1/in.	h2/in.	Part no.	\$/pc.
$\frac{3}{16}$	$1\frac{3}{8}$	840-2840-080-L	294.12
$\frac{3}{8}$	$1\frac{3}{8}$	840-2840-100-L	300.48
$\frac{7}{16}$	$1\frac{3}{8}$	840-2840-110-L	303.56
$\frac{1}{2}$	$1\frac{3}{8}$	840-2840-125-L	307.25

RIGHT VERSION**6.7**

STAINLESS STEEL, CHROME-PLATED

Length: 6.7 feet

Pack: 1 pc.

h1/in.	h2/in.	Part no.	\$/pc.
$\frac{3}{16}$	$1\frac{3}{8}$	840-2840-080-R	294.12
$\frac{3}{8}$	$1\frac{3}{8}$	840-2840-100-R	300.48
$\frac{7}{16}$	$1\frac{3}{8}$	840-2840-110-R	303.56
$\frac{1}{2}$	$1\frac{3}{8}$	840-2840-125-R	307.25

LEFT VERSION**4.10**

STAINLESS STEEL, CHROME-PLATED

Length: 4.10 feet

Pack: 1 pc.

h1/in.	h2/in.	Part no.	\$/pc.
$\frac{3}{16}$	$1\frac{1}{32}$	846-2840-080-L	221.93
$\frac{3}{8}$	$1\frac{1}{32}$	846-2840-100-L	224.79
$\frac{7}{16}$	$1\frac{1}{32}$	846-2840-110-L	226.03
$\frac{1}{2}$	$1\frac{1}{32}$	846-2840-125-L	227.05

RIGHT VERSION**4.10**

STAINLESS STEEL, CHROME-PLATED

Length: 4.10 feet

Pack: 1 pc.

h1/in.	h2/in.	Part no.	\$/pc.
$\frac{3}{16}$	$1\frac{1}{32}$	846-2840-080-R	221.93
$\frac{3}{8}$	$1\frac{1}{32}$	846-2840-100-R	224.79
$\frac{7}{16}$	$1\frac{1}{32}$	846-2840-110-R	226.03
$\frac{1}{2}$	$1\frac{1}{32}$	846-2840-125-R	227.05

LEFT VERSION**3.215**

STAINLESS STEEL, CHROME-PLATED

Length: 3.215 feet

Pack: 1 pc.

h1/in.	h2/in.	Part no.	\$/pc.
$\frac{3}{16}$	$\frac{1}{16}$	845-2840-080-L	140.70
$\frac{3}{8}$	$\frac{1}{16}$	845-2840-100-L	142.75
$\frac{7}{16}$	$\frac{1}{16}$	845-2840-110-L	143.78
$\frac{1}{2}$	$\frac{1}{16}$	845-2840-125-L	145.01

RIGHT VERSION**3.215**

STAINLESS STEEL, CHROME-PLATED

Length: 3.215 feet

Pack: 1 pc.

h1/in.	h2/in.	Part no.	\$/pc.
$\frac{3}{16}$	$\frac{1}{16}$	845-2840-080-R	140.70
$\frac{3}{8}$	$\frac{1}{16}$	845-2840-100-R	142.75
$\frac{7}{16}$	$\frac{1}{16}$	845-2840-110-R	143.78
$\frac{1}{2}$	$\frac{1}{16}$	845-2840-125-R	145.01

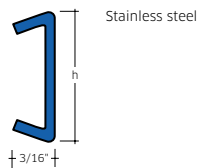

Advantages:

- > Elegant finish for floor-level showers
- > Provides a sleek, seamless, contemporary appearance of floor-level showers
- > Avoids oblique cuts of tiles

AQUA-DECO

AQUA-DECO is a sleek profile which is installed above a linear drain. This unique profile eliminates angled cuts of tile and creates the perfect finish for linear shower drains in combination with the AQUA-KEIL, AQUA-KEIL GLASS or AQUA-KEIL WALL.

STAINLESS STEEL 4.0 CHROME-PLATED

Length: 4.0 feet Pack: 1 pc.

h/in.	Part no.	\$/pc.
1 ⁵ / ₁₆	ZBL622-2840-24125	94.16
1 ¹ / ₄	ZBL622-2840-32125	104.19
1 ³ / ₈	ZBL622-2840-40125	114.50

STAINLESS STEEL 4.0 BRUSHED

Length: 4.0 feet Pack: 1 pc.

h/in.	Part no.	\$/pc.
1 ⁵ / ₁₆	ZBL622-280B-24125	80.48
1 ¹ / ₄	ZBL622-280B-32125	87.56
1 ³ / ₈	ZBL622-280B-40125	94.63

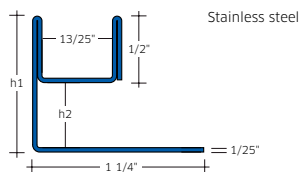

AQUA-GLASS (WALL AND FLOOR)

AQUA-GLASS (Wall and Floor), made from durable, maintenance free, stainless steel, is designed to securely hold glass partitions to tiled walls and level floors without having to drill into the wall or otherwise compromise the waterproofing layer under the tile. AQUA-GLASS can be combined with the AQUA-KEIL and AQUA-DECO products for a professionally finished and aesthetically pleasing installation.

STAINLESS STEEL 6.9 CHROME-PLATED

Length: 6.9 feet Pack: 1 pc.

h1/in.	h2/in.	Part no.	\$/pc.
1	1 ¹ / ₂	ZBL204-2840-210	582.66

STAINLESS STEEL 6.9 BRUSHED

Length: 6.9 feet Pack: 1 pc.

h1/in.	h2/in.	Part no.	\$/pc.
1	1 ¹ / ₂	ZBL204-280B-210	510.34

Advantages:

- > Easy installation without having to cut tiles. Install the AQUA-GLASS in the joint between the tile for a secure connection.
- > Install with thinset. No need to mechanically fix to the substrate and compromise the waterproofing layer.
- > Can be installed both on walls and on level floors.



AQUA-GLASS >

< AQUA-KEIL WALL

AQUA-DECO
v

AQUA-KEIL GLASS
v

Marble | Winter Frost & Silver



AQUA-KEIL GLASS (SLOPED FLOOR)

AQUA-KEIL GLASS (Sloped Floor) is the perfect solution for transition from a sloped tiled shower floor to a level adjacent floor where a glass partition or wall is needed. It is particularly useful for showers with a constant pitch down to a linear drain. Left and right versions are available.

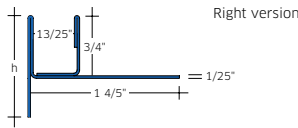
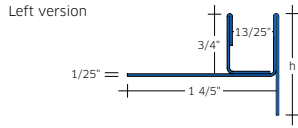

LEFT VERSION **6.7**

STAINLESS STEEL, CHROME-PLATED

Length: 6.7 feet

Pack: 1 pc.

h1/in.	Part no.	\$/pc.
2 ²⁵ / ₃₂	ZBL193-2840-200-L	561.30

RIGHT VERSION **6.7**

STAINLESS STEEL, CHROME-PLATED

Length: 6.7 feet

Pack: 1 pc.

h1/in.	Part no.	\$/pc.
2 ²⁵ / ₃₂	ZBL193-2840-200-R	561.30

LEFT VERSION **4.10**

STAINLESS STEEL, CHROME-PLATED

Length: 4.10 feet

Pack: 1 pc.

h1/in.	Part no.	\$/pc.
1 ²¹ / ₃₂	ZBL193-2840-148-L	367.87

RIGHT VERSION **4.10**

STAINLESS STEEL, CHROME-PLATED

Length: 4.10 feet

Pack: 1 pc.

h1/in.	Part no.	\$/pc.
1 ²¹ / ₃₂	ZBL193-2840-148-R	367.87

LEFT VERSION **3.9**

STAINLESS STEEL, CHROME-PLATED

Length: 3.9 feet

Pack: 1 pc.

h1/in.	Part no.	\$/pc.
1 ²⁹ / ₆₄	ZBL193-2840-120-L	340.68

RIGHT VERSION **3.9**

STAINLESS STEEL, CHROME-PLATED

Length: 3.9 feet

Pack: 1 pc.

h1/in.	Part no.	\$/pc.
1 ²⁹ / ₆₄	ZBL193-2840-120-R	340.68

LEFT VERSION **3.215**

STAINLESS STEEL, CHROME-PLATED

Length: 3.215 feet

Pack: 1 pc.

h1/in.	Part no.	\$/pc.
1 ¹ / ₃₂	ZBL193-2840-098-L	263.72

RIGHT VERSION **3.215**

STAINLESS STEEL, CHROME-PLATED

Length: 3.215 feet

Pack: 1 pc.

h1/in.	Part no.	\$/pc.
1 ¹ / ₃₂	ZBL193-2840-098-R	263.72



LEFT VERSION		6.7
STAINLESS STEEL, BRUSHED		
Length: 6.7 feet		Pack: 1 pc.
h1/in.	Part no.	\$/pc.
2 ³ / ₆₄	ZBL193-280B-200-L	505.67

RIGHT VERSION		6.7
STAINLESS STEEL, BRUSHED		
Length: 6.7 feet		Pack: 1 pc.
h1/in.	Part no.	\$/pc.
2 ³ / ₆₄	ZBL193-280B-200-R	505.67

LEFT VERSION		4.10
STAINLESS STEEL, BRUSHED		
Length: 4.10 feet		Pack: 1 pc.
h1/in.	Part no.	\$/pc.
1 ⁷ / ₃₂	ZBL193-280B-148-L	331.41

RIGHT VERSION		4.10
STAINLESS STEEL, BRUSHED		
Length: 4.10 feet		Pack: 1 pc.
h1/in.	Part no.	\$/pc.
1 ⁷ / ₃₂	ZBL193-280B-148-R	331.41

LEFT VERSION		3.9
STAINLESS STEEL, BRUSHED		
Length: 3.9 feet		Pack: 1 pc.
h1/in.	Part no.	\$/pc.
1 ²⁹ / ₆₄	ZBL193-280B-120-L	306.92

RIGHT VERSION		3.9
STAINLESS STEEL, BRUSHED		
Length: 3.9 feet		Pack: 1 pc.
h1/in.	Part no.	\$/pc.
1 ²⁹ / ₆₄	ZBL193-280B-120-R	306.92

LEFT VERSION		3.215
STAINLESS STEEL, BRUSHED		
Length: 3.215 feet		Pack: 1 pc.
h1/in.	Part no.	\$/pc.
1 ¹ / ₃₂	ZBL193-280B-098-L	237.58

RIGHT VERSION		3.215
STAINLESS STEEL, BRUSHED		
Length: 3.215 feet		Pack: 1 pc.
h1/in.	Part no.	\$/pc.
1 ¹ / ₃₂	ZBL193-280B-098-R	237.58

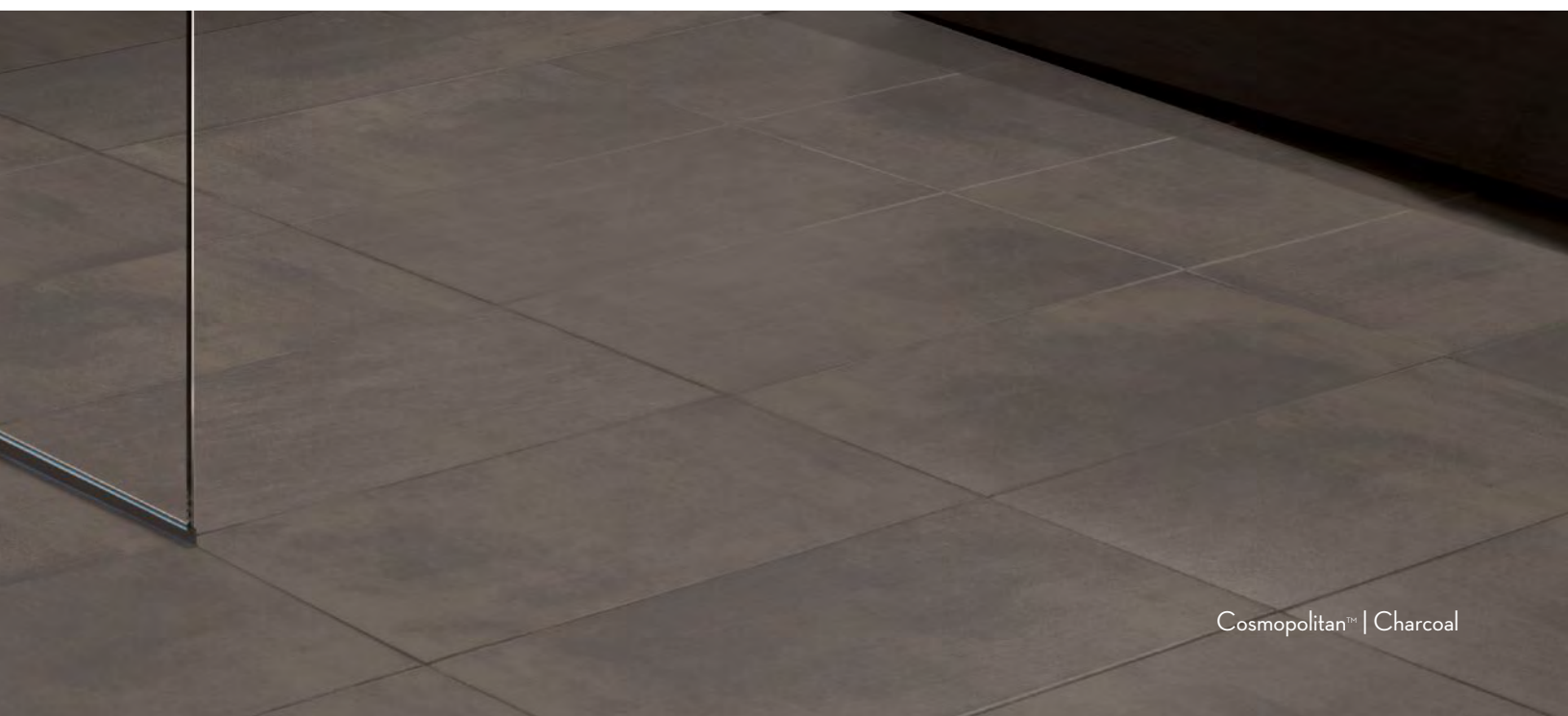



WATERPROOFING SYSTEMS

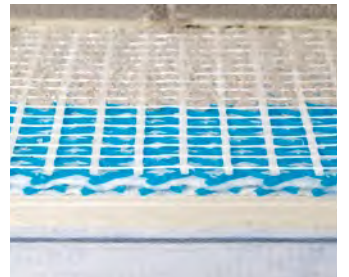

74 ULTRA-DRAIN

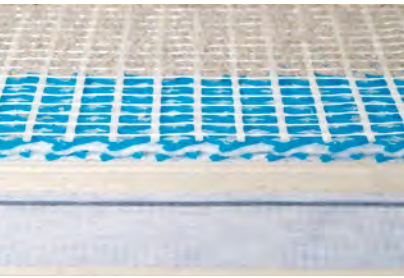

ULTRA-DRAIN

The ULTRA-DRAIN is the first drain mat system that can be installed without a thick mortar bed and offers all the stress absorption properties of an uncoupling system. The superior drainage properties prevent freeze/thaw damage caused by the accumulation of moisture in exterior tile installations and help reduce unsightly efflorescence. Although only 1/4" thick, it provides superior compressive and tensile strength when compared to other drain mats and uncoupling systems.

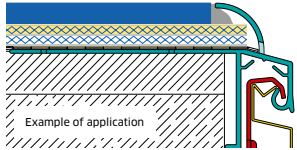

ULTRA-DRAIN

15 sheets per carton = 97.5 sq. ft.
1 sheet = 6.5 sq. ft.

Pack: 1 carton

width/length	Art. no.	\$/carton
2' x 3.2'	ZBL528-904	728.18

Important note:

Particularly suitable for exterior use

Advantages:

- > Prevents freeze/thaw damage and efflorescence
- > Provides superior compressive and tensile strength
- > Provides crack isolation properties

- 1 Tile adhesive
- 2 ULTRA-DRAIN PROFILE
- 3 Approved Waterproof Adhesive
- 4 Tile adhesive
- 5 Approved Waterproof Membrane
- 6 Tile adhesive
- 7 ULTRA-DRAIN
- 8 Permeable mortar
- 9 Tile adhesive
- 10 Tile

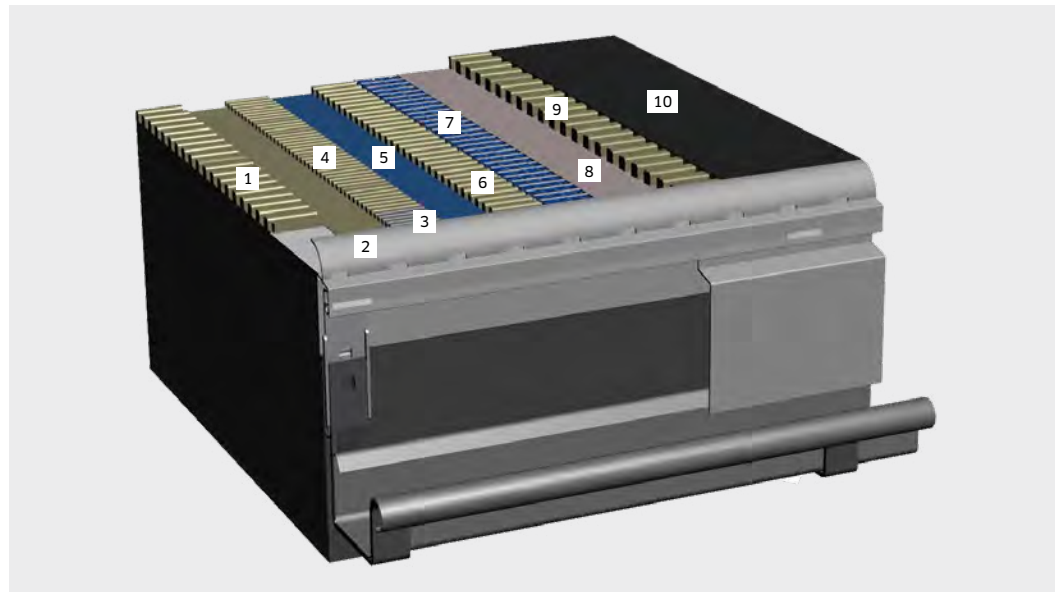





BALCONY & TERRACE PROFILES

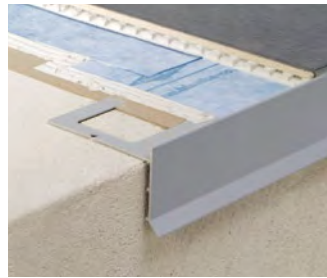

82 BALCONYEDGE
PROTECTOR PRO



87 GRAVEL
DECK EDGE

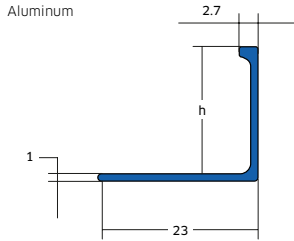
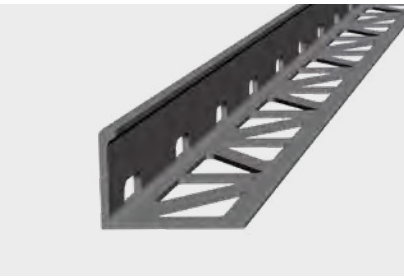

DE PROFILE

The innovative DE PROFILE is a powder-coated aluminum profile with weep holes to allow for drainage while giving tile installations a subtle and protective finish. Essential for any terrace or balcony job, the DE PROFILE can be easily used in conjunction with drainage mats for the ultimate in protection against water damage and stress to tile edges.

ALUMINUM 8.0			ALUMINUM 8.0			ALUMINUM 8.0		
GRAY, POWDER-COATED			OLD COPPER BROWN, POWDER-COATED			STAINLESS STEEL METALLIC, POWDER-COATED		
Length: 8.0 feet			Length: 8.0 feet			Length: 8.0 feet		
Pack: 1 pc.			Pack: 1 pc.			Pack: 1 pc.		
h/in.	Part no.	\$/pc.	h/in.	Part no.	\$/pc.	h/in.	Part no.	\$/pc.
7/16	ZBL302-4591-11025	22.32	7/16	ZBL302-4581-11025	22.32	7/16	ZBL302-4502-11025	22.32
1/2	ZBL302-4591-12525	23.12	1/2	ZBL302-4581-12525	23.12	1/2	ZBL302-4502-12525	23.12
3/4	ZBL302-4591-18525	26.68	3/4	ZBL302-4581-18525	26.68	3/4	ZBL302-4502-18525	26.68
13/16	ZBL302-4591-20025	27.30	13/16	ZBL302-4581-20025	27.30	13/16	ZBL302-4502-20025	27.30
7/8	ZBL302-4591-22025	27.77	7/8	ZBL302-4581-22025	27.77	7/8	ZBL302-4502-22025	27.77
15/16	ZBL302-4591-30025	29.77	15/16	ZBL302-4581-30025	29.77	15/16	ZBL302-4502-30025	29.77

- 1 Tile adhesive
- 2 BALCONY-Gutter Edge Protector
- 3 Waterproof Tile Adhesive/Sealant
- 4 Tile adhesive
- 5 Waterproofing Membrane
- 6 Tile adhesive
- 7 DE PROFILE
- 8 ULTRA-DRAIN
- 9 Permeable mortar
- 10 Tile adhesive
- 11 Tile

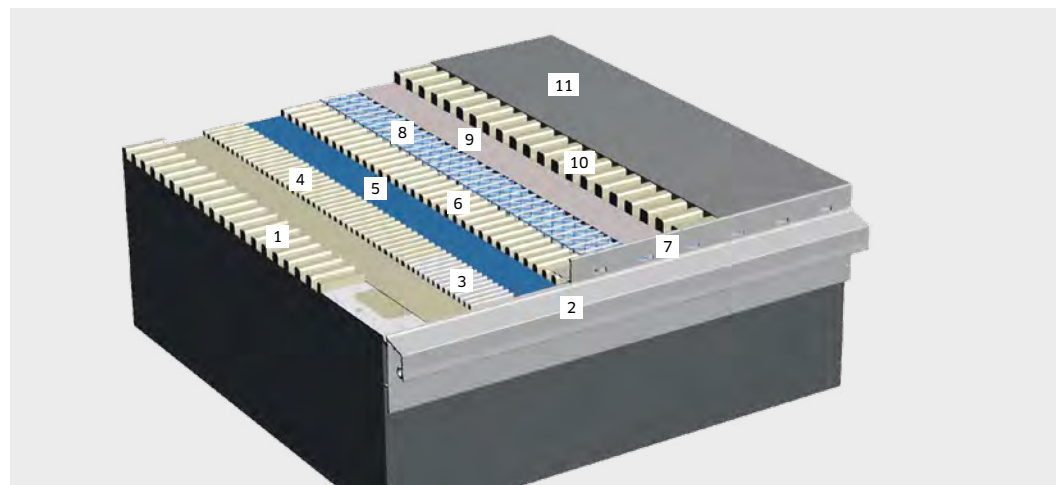

- 1 Tile adhesive
- 2 BALCONY EDGE PROTECTOR PLUS
- 3 Waterproof Tile Adhesive/Sealant
- 4 Tile adhesive
- 5 Waterproofing Membrane
- 6 Tile adhesive
- 7 DE PROFILE
- 8 ULTRA-DRAIN
- 9 Permeable mortar
- 10 Tile adhesive
- 11 Tile

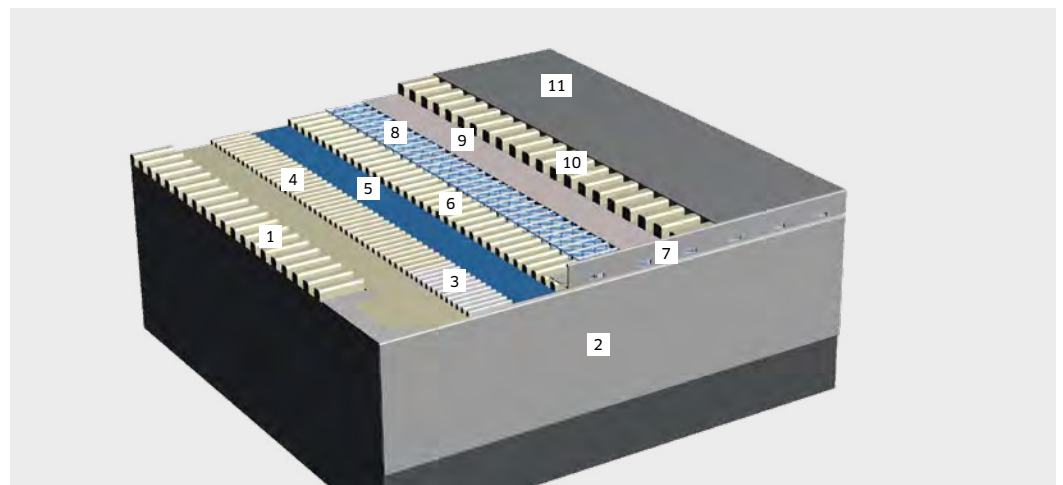

BALCONY-GUTTER QUARTER CIRCLE TRIM

This BALCONY TRIM is designed to protect the edge of the tile installed over our underlayment, and to cover the edge of the exposed balcony/terrace substrate. The profile features an overhang extension deflecting water running off the tile installation from the balcony substrate. This extension can also hold additional components of the BALCONY system including the gutter holder and gutter shield. Drainage holes allow for run-off of moisture collected by the drain mat system.



ALUMINUM 8.0		
GRAY, POWDER-COATED		
Length: 8.0 feet		Pack: 1 pc.
h/in.	Part no.	\$/pc.
1/16"	ZBL430-4591-180	185.36

ALUMINUM 8.0		
OLD COPPER BROWN, POWDER-COATED		
Length: 8.0 feet		Pack: 1 pc.
h/in.	Part no.	\$/pc.
1/16"	ZBL430-4581-180	185.36

ALUMINUM 8.0		
STAINLESS STEEL METALLIC, POWDER-COATED		
Length: 8.0 feet		Pack: 1 pc.
h/in.	Part no.	\$/pc.
1/16"	ZBL430-4502-180	190.92

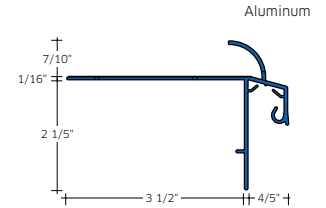

JOINER

ALUMINUM		
GRAY, POWDER-COATED		
Width: 1 3/16"		Pack: 5 pcs.
h/in.	Part no.	\$/pack
1/16"	ZBL432-4591-180	48.49

ALUMINUM		
OLD COPPER BROWN, POWDER-COATED		
Width: 1 3/16"		Pack: 5 pcs.
h/in.	Part no.	\$/pack
1/16"	ZBL432-4581-180	48.49

ALUMINUM		
STAINLESS STEEL METALLIC, POWDER-COATED		
Width: 1 3/16"		Pack: 5 pcs.
h/in.	Part no.	\$/pack
1/16"	ZBL432-4502-180	49.96

OUTER CORNER JOINER 90°, OUTER DIMENSION 9 1/2" · 9 1/2"

ALUMINUM 90°		
GRAY, POWDER-COATED		
Pack: 1 pc.		
h/in.	Part no.	\$/pc.
3/4"	ZBL433-4591-180090	92.53

ALUMINUM 90°		
OLD COPPER BROWN, POWDER-COATED		
Pack: 1 pc.		
h/in.	Part no.	\$/pc.
3/4"	ZBL433-4581-180090	92.53

ALUMINUM 90°		
STAINLESS STEEL METALLIC, POWDER-COATED		
Pack: 1 pc.		
h/in.	Part no.	\$/pc.
3/4"	ZBL433-4502-180090	95.31

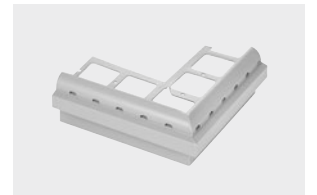

OUTER CORNER JOINER 135°, OUTER DIMENSION 9 1/2" · 9 1/2"

ALUMINUM 135°		
GRAY, POWDER-COATED		
Pack: 1 pc.		
h/in.	Part no.	\$/pc.
3/4"	ZBL433-4591-180135	108.81

ALUMINUM 135°		
OLD COPPER BROWN, POWDER-COATED		
Pack: 1 pc.		
h/in.	Part no.	\$/pc.
3/4"	ZBL433-4581-180135	108.81

ALUMINUM 135°		
STAINLESS STEEL METALLIC, POWDER-COATED		
Pack: 1 pc.		
h/in.	Part no.	\$/pc.
3/4"	ZBL433-4502-180135	112.07

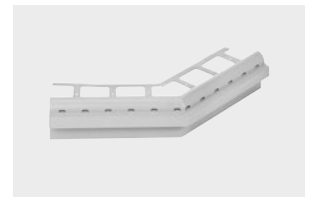

INNER CORNER JOINER 90°, OUTER DIMENSION 5 1/8" · 5 1/8"

ALUMINUM 90°		
GRAY, POWDER-COATED		
Pack: 1 pc.		
h/in.	Part no.	\$/pc.
3/4"	ZBL649-4591-180090	108.81

ALUMINUM 90°		
OLD COPPER BROWN, POWDER-COATED		
Pack: 1 pc.		
h/in.	Part no.	\$/pc.
3/4"	ZBL649-4581-180090	108.81

ALUMINUM 90°		
STAINLESS STEEL METALLIC, POWDER-COATED		
Pack: 1 pc.		
h/in.	Part no.	\$/pc.
3/4"	ZBL649-4502-180090	112.07





UNIVERSAL JOINER

METAL
ZINC PLATED

Pack: 10 pcs.

width/length	Art. no.	\$/pack
1/16" x 3"	ZBL436-110	15.13



BALCONY-GUTTER EDGE PROTECTOR

This balcony trim is designed to protect the edge of the balcony substrate and the edge of tile installed over a waterproofing fabric. This balcony edge features an overhang extension deflecting water running off the tile installation from the balcony substrate. Accessories such as joiners are available.

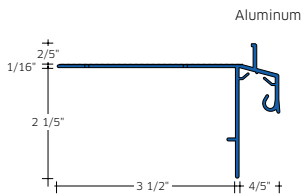

ALUMINUM 8.0
MEDIUM GRAY, POWDER-COATED

Length: 8.0 feet Pack: 1 pc.

h/in.	Part no.	\$/pc.
5/2	ZBL445-4591-105	174.01

JOINER

OUTER CORNER JOINER 90°, OUTER DIMENSION 9 1/2" · 9 1/2"

UNIVERSAL JOINER

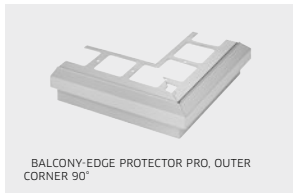

ALUMINUM
MEDIUM GRAY, POWDER-COATED

Height: 3/8" Pack: 5 pcs.

h/in.	Part no.	\$/pack
1 1/6	ZBL437-4591-105	48.42

ALUMINUM 90°
MEDIUM GRAY, POWDER-COATED

Pack: 1 pc.

h/in.	Part no.	\$/pc.
3/2	ZBL446-4591-105090	92.58

METAL
ZINC PLATED

Pack: 10 pcs.

width/length	Art. no.	\$/pack
1/16" x 3"	ZBL436-110	15.13





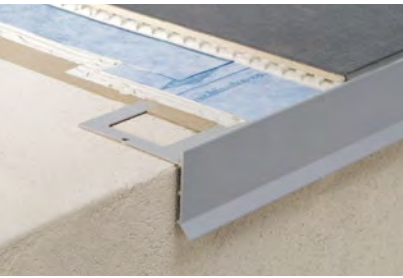

BALCONY-EDGE PROTECTOR PRO

The BALCONY-Edge Protector PRO is designed to protect the edge of the balcony substrate and the edge of tile installed over a water proofing fabric. This balcony edge features a drain lip that helps deflect water from the balcony substrate. Accessories such as connecting and corner joiners are available for ease of installation.

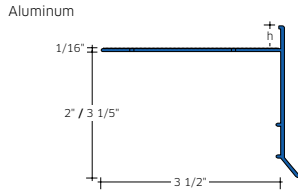

ALUMINUM 8.0		
MEDIUM GRAY, POWDER-COATED		
h to be covered 3/8"		Pack: 1 pc.
h/in.	Part no.	\$/pc.
3/8	ZBL592-4591-105	151.83
1/2	ZBL592-4591-125	159.42

ALUMINUM 8.0		
MEDIUM GRAY, POWDER-COATED		
h to be covered 2"		Pack: 1 pc.
h/in.	Part no.	\$/pc.
1/2	ZBL406-4591-085	145.20
3/8	ZBL406-4591-105	145.20

ALUMINUM 8.0		
STAINLESS STEEL METALLIC, POWDER-COATED		
h to be covered 3/8"		Pack: 1 pc.
h/in.	Part no.	\$/pc.
3/8	ZBL592-4502-105	156.39
1/2	ZBL592-4502-125	163.62

ALUMINUM 8.0		
STAINLESS STEEL METALLIC, POWDER-COATED		
h to be covered 2"		Pack: 1 pc.
h/in.	Part no.	\$/pc.
3/8	ZBL406-4502-105	149.56

ALUMINUM 8.0		
OLD COPPER BROWN, POWDER-COATED		
h to be covered 3/8"		Pack: 1 pc.
h/in.	Part no.	\$/pc.
3/8	ZBL592-4581-105	151.83
1/2	ZBL592-4581-125	159.42

ALUMINUM 8.0		
OLD COPPER BROWN, POWDER-COATED		
h to be covered 2"		Pack: 1 pc.
h/in.	Part no.	\$/pc.
3/8	ZBL406-4581-105	145.20

JOINER

ALUMINUM		
MEDIUM GRAY, POWDER-COATED		
h to be covered 3/8"		Pack: 5 pcs.
h/in.	Part no.	\$/pack
3/8	ZBL594-4591-105	48.85
1/2	ZBL594-4591-125	48.85

ALUMINUM		
MEDIUM GRAY, POWDER-COATED		
h to be covered 2"		Pack: 5 pcs.
h/in.	Part no.	\$/pack
1/2	ZBL407-4591-085	48.42
3/8	ZBL407-4591-105	48.42

ALUMINUM		
STAINLESS STEEL METALLIC, POWDER-COATED		
h to be covered 3/8"		Pack: 5 pcs.
h/in.	Part no.	\$/pack
3/8	ZBL594-4502-105	50.31
1/2	ZBL594-4502-125	50.31

ALUMINUM		
STAINLESS STEEL METALLIC, POWDER-COATED		
h to be covered 2"		Pack: 5 pcs.
h/in.	Part no.	\$/pack
3/8	ZBL407-4502-105	49.87

ALUMINUM		
OLD COPPER BROWN, POWDER-COATED		
h to be covered 3/8"		Pack: 5 pcs.
h/in.	Part no.	\$/pack
3/8	ZBL594-4581-105	48.85
1/2	ZBL594-4581-125	48.85

ALUMINUM		
OLD COPPER BROWN, POWDER-COATED		
h to be covered 2"		Pack: 5 pcs.
h/in.	Part no.	\$/pack
3/8	ZBL407-4581-105	48.42

OUTER CORNER JOINER 90°, OUTER DIMENSION 9 1/2" · 9 1/2"

ALUMINUM 90°		
MEDIUM GRAY, POWDER-COATED		
h to be covered 3/4"		Pack: 1 pc.
h/in.	Part no.	\$/pc.
3/8	ZBL596-4591-105090	93.30
1/2	ZBL596-4591-125090	93.30

ALUMINUM 90°		
MEDIUM GRAY, POWDER-COATED		
h to be covered 2"		Pack: 1 pc.
h/in.	Part no.	\$/pc.
1/3	ZBL447-4591-085090	88.16
3/8	ZBL447-4591-105090	88.16

ALUMINUM 90°		
STAINLESS STEEL METALLIC, POWDER-COATED		
h to be covered 3/4"		Pack: 1 pc.
h/in.	Part no.	\$/pc.
3/8	ZBL596-4502-105090	96.09
1/2	ZBL596-4502-125090	96.09

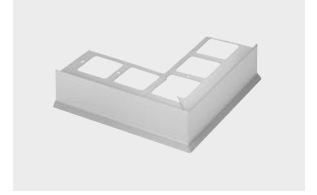

ALUMINUM 90°		
STAINLESS STEEL METALLIC, POWDER-COATED		
h to be covered 2"		Pack: 1 pc.
h/in.	Part no.	\$/pc.
3/8	ZBL447-4502-105090	95.36

ALUMINUM 90°		
OLD COPPER BROWN, POWDER-COATED		
h to be covered 3/4"		Pack: 1 pc.
h/in.	Part no.	\$/pc.
3/8	ZBL596-4581-105090	93.30
1/2	ZBL596-4581-125090	93.30

ALUMINUM 90°		
OLD COPPER BROWN, POWDER-COATED		
h to be covered 2"		Pack: 1 pc.
h/in.	Part no.	\$/pc.
3/8	ZBL447-4581-105090	92.58

OUTER CORNER JOINER 135°, OUTER DIMENSION 9 1/2" · 9 1/2"

ALUMINUM 135°		
MEDIUM GRAY, POWDER-COATED		
h to be covered 3/4"		Pack: 1 pc.
h/in.	Part no.	\$/pc.
3/8	ZBL596-4591-105135	108.79
1/2	ZBL596-4591-125135	108.79

ALUMINUM 135°		
MEDIUM GRAY, POWDER-COATED		
h to be covered 2"		Pack: 1 pc.
h/in.	Part no.	\$/pc.
3/8	ZBL447-4591-105135	108.79

ALUMINUM 135°		
STAINLESS STEEL METALLIC, POWDER-COATED		
h to be covered 3/4"		Pack: 1 pc.
h/in.	Part no.	\$/pc.
3/8	ZBL596-4502-105135	112.05
1/2	ZBL596-4502-125135	112.05

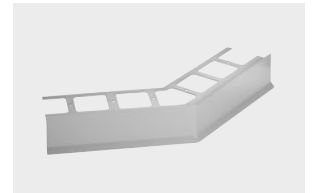

ALUMINUM 135°		
STAINLESS STEEL METALLIC, POWDER-COATED		
h to be covered 2"		Pack: 1 pc.
h/in.	Part no.	\$/pc.
3/8	ZBL447-4502-105135	112.05

ALUMINUM 135°		
OLD COPPER BROWN, POWDER-COATED		
h to be covered 3/4"		Pack: 1 pc.
h/in.	Part no.	\$/pc.
3/8	ZBL596-4581-105135	108.79
1/2	ZBL596-4581-125135	108.79

ALUMINUM 135°		
OLD COPPER BROWN, POWDER-COATED		
h to be covered 2"		Pack: 1 pc.
h/in.	Part no.	\$/pc.
3/8	ZBL447-4581-105135	108.79

INNER CORNER JOINER 90°, OUTER DIMENSION 5 9/10" · 5 9/10"

ALUMINUM 90°		
MEDIUM GRAY, POWDER-COATED		
h to be covered 3/4"		Pack: 1 pc.
h/in.	Part no.	\$/pc.
3/8	ZBL648-4591-105090	108.79
1/2	ZBL648-4591-125090	108.79

ALUMINUM 90°		
MEDIUM GRAY, POWDER-COATED		
h to be covered 2"		Pack: 1 pc.
h/in.	Part no.	\$/pc.
3/8	ZBL645-4591-105090	108.79

ALUMINUM 90°		
STAINLESS STEEL METALLIC, POWDER-COATED		
h to be covered 3/4"		Pack: 1 pc.
h/in.	Part no.	\$/pc.
3/8	ZBL648-4502-105090	112.05
1/2	ZBL648-4502-125090	112.05

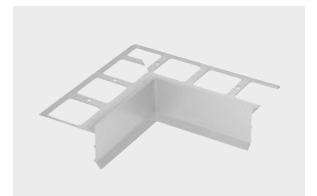

ALUMINUM 90°		
STAINLESS STEEL METALLIC, POWDER-COATED		
h to be covered 2"		Pack: 1 pc.
h/in.	Part no.	\$/pc.
3/8	ZBL645-4502-105090	112.05

ALUMINUM 90°		
OLD COPPER BROWN, POWDER-COATED		
h to be covered 3/4"		Pack: 1 pc.
h/in.	Part no.	\$/pc.
3/8	ZBL648-4581-105090	108.79
1/2	ZBL648-4581-125090	108.79

ALUMINUM 90°		
OLD COPPER BROWN, POWDER-COATED		
h to be covered 2"		Pack: 1 pc.
h/in.	Part no.	\$/pc.
3/8	ZBL645-4581-105090	108.79



BALCONY-EDGE PROTECTOR

The BALCONY-EDGE PROTECTOR provides an attractive cover for concrete balconies and terrace slabs. Straight and corner joiner pieces can be used to easily connect two BALCONY-EDGE PROTECTOR lengths.

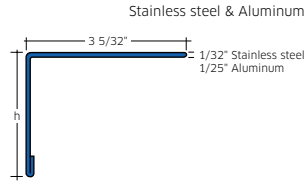

STAINLESS STEEL 8.0

NATURAL

Length: 8.0 feet Pack: 1 pc.

h/in.	Part no.	\$/pc.
2 3/8	ZBL341-280-06025	105.70
3 3/8	ZBL341-280-08025	119.06
4	ZBL341-280-10025	129.63

ALUMINUM 8.0

WHITE, POWDER-COATED

Length: 8.0 feet Pack: 1 pc.

h/in.	Part no.	\$/pc.
2 3/8	ZBL341-450-06025	74.56
3 3/8	ZBL341-450-08025	80.12
4	ZBL341-450-10025	86.79

ALUMINUM 8.0

MEDIUM GRAY, POWDER-COATED

Length: 8.0 feet Pack: 1 pc.

h/in.	Part no.	\$/pc.
2 3/8	ZBL341-45919-06025	74.56
3 3/8	ZBL341-45919-08025	80.12
4	ZBL341-45919-10025	86.79

ALUMINUM 8.0

BROWN, POWDER-COATED

Length: 8.0 feet Pack: 1 pc.

h/in.	Part no.	\$/pc.
2 3/8	ZBL341-460-06025	74.56
3 3/8	ZBL341-460-08025	80.12
4	ZBL341-460-10025	86.79

JOINER

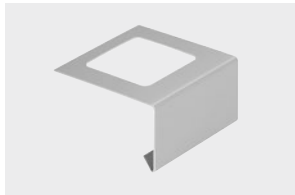

STAINLESS STEEL

NATURAL

Length: 3 3/8" Pack: 1 pc.

h/in.	Part no.	\$/pc.
1 3/8	ZBL351-280-040	17.25
2 3/8	ZBL351-280-060	17.25
3 3/8	ZBL351-280-080	18.14
3 3/8	ZBL351-280-100	19.06

ALUMINUM

WHITE, POWDER-COATED

Length: 3 3/8" Pack: 1 pc.

h/in.	Part no.	\$/pc.
2 3/8	ZBL351-450-060	11.56
3 3/8	ZBL351-450-080	12.38
3 3/8	ZBL351-450-100	12.86
4 3/8	ZBL351-450-125	13.40

ALUMINUM

MEDIUM GRAY, POWDER-COATED

Length: 3 3/8" Pack: 1 pc.

h/in.	Part no.	\$/pc.
1 3/8	ZBL351-45919-040	11.56
2 3/8	ZBL351-45919-060	11.56
3 3/8	ZBL351-45919-080	12.38
3 3/8	ZBL351-45919-100	12.86
4 3/8	ZBL351-45919-125	13.40

ALUMINUM

BROWN, POWDER-COATED

Length: 3 3/8" Pack: 1 pc.

h/in.	Part no.	\$/pc.
2 3/8	ZBL351-460-060	11.56
3 3/8	ZBL351-460-080	12.38
3 3/8	ZBL351-460-100	12.86
4 3/8	ZBL351-460-125	13.40

CORNER JOINER 90°

STAINLESS STEEL 90°
NATURAL

Length: 3½" Pack: 1 pc.

h/in.	Part no.	\$/pc.
1¾	ZBL352-280-040	35.39
2 ⁹ / ₂₅	ZBL352-280-060	35.39
3¾	ZBL352-280-080	36.51
3 ²³ / ₂₅	ZBL352-280-100	37.14

ALUMINUM 90°
WHITE, POWDER-COATED

Length: 3½" Pack: 1 pc.

h/in.	Part no.	\$/pc.
2 ⁹ / ₂₅	ZBL352-450-060	22.12
3¾	ZBL352-450-080	23.24
3 ²³ / ₂₅	ZBL352-450-100	24.34
4 ²³ / ₂₅	ZBL352-450-125	25.57

ALUMINUM 90°
MEDIUM GRAY, POWDER-COATED

Length: 3½" Pack: 1 pc.

h/in.	Part no.	\$/pc.
1¾	ZBL352-45919-040	22.12
2 ⁹ / ₂₅	ZBL352-45919-060	22.12
3¾	ZBL352-45919-080	23.24
3 ²³ / ₂₅	ZBL352-45919-100	24.34
4 ²³ / ₂₅	ZBL352-45919-125	25.57

ALUMINUM 90°
BROWN, POWDER-COATED

Length: 3½" Pack: 1 pc.

h/in.	Part no.	\$/pc.
2 ⁹ / ₂₅	ZBL352-460-060	22.12
3¾	ZBL352-460-080	23.24
3 ²³ / ₂₅	ZBL352-460-100	24.34
4 ²³ / ₂₅	ZBL352-460-125	25.57

BALCONY-EDGE PROTECTOR PLUS

The BALCONY-EDGE PROTECTOR PLUS facilitates quick and simple expansion in balcony renovations and when building balconies. Connectors and corners complete this fully developed system.

**ALUMINUM** 8.0
WHITE, POWDER-COATED

Length: 8.0 feet Pack: 1 pc.

h/in.	Part no.	\$/pc.
2 ⁹ / ₂₅	ZBL341-450P-08025	103.37
3¾	ZBL341-450P-10025	113.43
3 ²³ / ₂₅	ZBL341-450P-12525	141.73

ALUMINUM 8.0
MEDIUM GRAY, POWDER-COATED

Length: 8.0 feet Pack: 1 pc.

h/in.	Part no.	\$/pc.
2 ⁹ / ₂₅	ZBL341-45919P08025	103.37
3¾	ZBL341-45919P10025	113.43
3 ²³ / ₂₅	ZBL341-45919P12525	141.73

ALUMINUM 8.0
BROWN, POWDER-COATED

Length: 8.0 feet Pack: 1 pc.

h/in.	Part no.	\$/pc.
2 ⁹ / ₂₅	ZBL341-460P-08025	103.37
3¾	ZBL341-460P-10025	113.43
3 ²³ / ₂₅	ZBL341-460P-12525	141.73

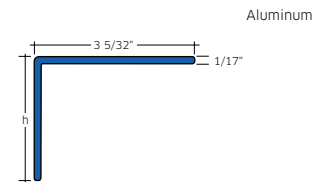



BALCONY-GRAVEL DECK EDGE PRO

The BALCONY-GRAVEL DECK EDGE PRO is a balcony profile for tile and stone with a slide-in opening designed for inserting a drain mat. It has weep holes for the optimal drainage of moisture on balconies and terraces. The system is completed by joiners and seamwelded corners.

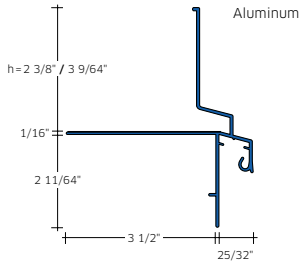

ALUMINUM 8.0			ALUMINUM 8.0			ALUMINUM 8.0		
MEDIUM GRAY, POWDER-COATED			OLD COPPER BROWN, POWDER-COATED			STAINLESS STEEL METALLIC, POWDER-COATED		
Length: 8.0 feet			Length: 8.0 feet			Length: 8.0 feet		
Pack: 1 pc.			Pack: 1 pc.			Pack: 1 pc.		
h/in.	Part no.	\$/pc.	h/in.	Part no.	\$/pc.	h/in.	Part no.	\$/pc.
2 ²⁵ / ₃₂	ZBL575-4591-060	109.60	2 ²⁵ / ₃₂	ZBL575-4581-060	109.60	2 ²⁵ / ₃₂	ZBL575-4502-060	112.83
3%	ZBL575-4591-080	113.18	3%	ZBL575-4581-080	113.18	3%	ZBL575-4502-080	115.81

JOINER

ALUMINUM			ALUMINUM			ALUMINUM		
MEDIUM GRAY, POWDER-COATED			OLD COPPER BROWN, POWDER-COATED			STAINLESS STEEL METALLIC, POWDER-COATED		
Length 1 ³⁷ / ₆₄ feet			Length 1 ³⁷ / ₆₄ feet			Length 1 ³⁷ / ₆₄ feet		
Pack: 5 pcs.			Pack: 5 pcs.			Pack: 5 pcs.		
h/in.	Part no.	\$/pack	h/in.	Part no.	\$/pack	h/in.	Part no.	\$/pack
2 ²⁵ / ₃₂	ZBL577-4591-060	50.13	2 ²⁵ / ₃₂	ZBL577-4581-060	50.13	2 ²⁵ / ₃₂	ZBL577-4502-060	51.62
3%	ZBL577-4591-080	50.44	3%	ZBL577-4581-080	50.44	3%	ZBL577-4502-080	51.96

CORNER JOINER 90°, OUTER DIMENSION 9 29/64" · 9 29/64"



ALUMINUM 90°			ALUMINUM 90°			ALUMINUM 90°		
MEDIUM GRAY, POWDER-COATED			OLD COPPER BROWN, POWDER-COATED			STAINLESS STEEL METALLIC, POWDER-COATED		
Pack: 1 pc.			Pack: 1 pc.			Pack: 1 pc.		
h/in.	Part no.	\$/pc.	h/in.	Part no.	\$/pc.	h/in.	Part no.	\$/pc.
2 ²⁵ / ₃₂	ZBL578-4591-060090	123.51	2 ²⁵ / ₃₂	ZBL578-4581-060090	123.51	2 ²⁵ / ₃₂	ZBL578-4502-060090	127.21
3%	ZBL578-4591-080090	125.07	3%	ZBL578-4581-080090	125.07	3%	ZBL578-4502-080090	128.77

CORNER JOINER 135°, OUTER DIMENSION 9 29/64" · 9 29/64"

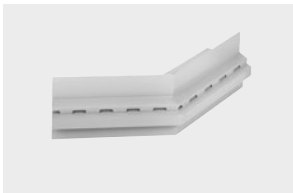

ALUMINUM 135°			ALUMINUM 135°			ALUMINUM 135°		
MEDIUM GRAY, POWDER-COATED			OLD COPPER BROWN, POWDER-COATED			STAINLESS STEEL METALLIC, POWDER-COATED		
Pack: 1 pc.			Pack: 1 pc.			Pack: 1 pc.		
h/in.	Part no.	\$/pc.	h/in.	Part no.	\$/pc.	h/in.	Part no.	\$/pc.
2 ²⁵ / ₃₂	ZBL578-4591-060135	148.18	2 ²⁵ / ₃₂	ZBL578-4581-060135	148.18	2 ²⁵ / ₃₂	ZBL578-4502-060135	152.62
3%	ZBL578-4591-080135	150.05	3%	ZBL578-4581-080135	150.05	3%	ZBL578-4502-080135	154.55

INNER CORNER JOINER 90°, OUTER DIMENSION 5 1/8" · 5 1/8"

ALUMINUM
MEDIUM GRAY,
POWDER-COATED

90°

Pack: 1 pc.

h/in.	Part no.	\$/pc.
2 ⁵ / ₁₆	ZBL650-4591-060090	148.18
3%	ZBL650-4591-080090	150.05

ALUMINUM
OLD COPPER BROWN,
POWDER-COATED

90°

Pack: 1 pc.

h/in.	Part no.	\$/pc.
2 ⁵ / ₁₆	ZBL650-4581-060090	148.18
3%	ZBL650-4581-080090	150.05

ALUMINUM
STAINLESS STEEL METALLIC,
POWDER-COATED

90°

Pack: 1 pc.

h/in.	Part no.	\$/pc.
2 ⁵ / ₁₆	ZBL650-4502-060090	152.62
3%	ZBL650-4502-080090	154.55



UNIVERSAL JOINER

METAL
ZINC PLATED

Pack: 10 pcs.

width/length	Art. no.	\$/pack
1 ¹ / ₁₆ " × 3"	ZBL436-110	15.13



GRAVEL DECK EDGE

The GRAVEL DECK EDGE has specially designed drainage holes allowing moisture to escape while containing terrace and balcony deck substrates consisting of loose gravel layered on drainage mat system. Available in durable aluminum or stainless steel.

**STAINLESS STEEL**
BRUSHED

8.0

Length: 8.0 feet

Pack: 1 pc.

h/in.	Part no.	\$/pc.
1 ³ / ₁₆	ZBL345-280B-035	207.05
2 ⁹ / ₁₆	ZBL345-280B-065	223.51
3	ZBL345-280B-075	229.82

ALUMINUM
MEDIUM GRAY, POWDER-COATED

8.0

Length: 8.0 feet

Pack: 1 pc.

h/in.	Part no.	\$/pc.
1 ³ / ₁₆	ZBL345-45919-035	85.21
2 ⁹ / ₁₆	ZBL345-45919-065	110.17
3	ZBL345-45919-075	113.49

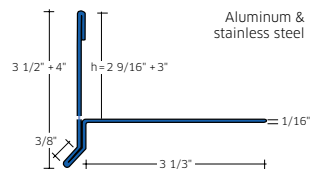

JOINER

STAINLESS STEEL
BRUSHED

Length: 3 1/2"

Pack: 1 pc.

h/in.	Part no.	\$/pc.
1 ³ / ₁₆	ZBL499-280B-035	24.92
2 ⁹ / ₁₆	ZBL499-280B-065	26.65
3	ZBL499-280B-075	27.26

ALUMINUM
MEDIUM GRAY, POWDER-COATED

Length: 3 1/2"

Pack: 1 pc.

h/in.	Part no.	\$/pc.
1 ³ / ₁₆	ZBL499-45919-035	16.69
2 ⁹ / ₁₆	ZBL499-45919-065	19.86
3	ZBL499-45919-075	22.21

CORNER JOINER 90°, OUTER DIMENSION 3 1/6" · 3 1/6"



**STAINLESS STEEL
BRUSHED**

Pack: 1 pc.		
h/in.	Part no.	\$/pc.
1 3/8	ZBL501-280B-035	43.99
2 3/16	ZBL501-280B-065	48.89
3	ZBL501-280B-075	51.24

**ALUMINUM
MEDIUM GRAY, POWDER-COATED**

Pack: 1 pc.		
h/in.	Part no.	\$/pc.
1 3/8	ZBL501-45919-035	27.41
2 3/16	ZBL501-45919-065	31.85
3	ZBL501-45919-075	33.50



COVECOVER

The COVECOVER is a cove profile that is designed to provide attractive interior wall protection. The innovative and durable design protects exterior baseboards.

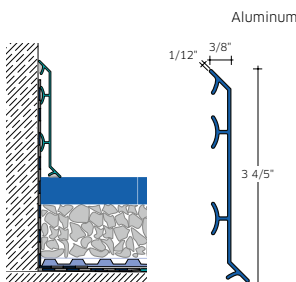

ALUMINUM 8.0 MEDIUM GRAY, POWDER-COATED		
Length: 8.0 feet Pack: 1 pc.		
h/in.	Part no.	\$/pc.
4	ZBL639-4591	193.32

ALUMINUM 8.0 OLD COPPER BROWN, POWDER-COATED		
Length: 8.0 feet Pack: 1 pc.		
h/in.	Part no.	\$/pc.
4	ZBL639-4581	193.32

ALUMINUM 8.0 STAINLESS STEEL METALLIC, POWDER-COATED		
Length: 8.0 feet Pack: 1 pc.		
h/in.	Part no.	\$/pc.
4	ZBL639-4502	199.08

Advantages:

- > Durable attractive alternative when covebase tile is not available or too expensive.
- > Hollow channels on the back ideal for »hiding« electric cords, cables, etc.
- > Convenient corners and joiners are available for achieving a professional finish

Expert tip:

For rapid, secure attachment to walls etc.

JOINER

ALUMINUM MEDIUM GRAY, POWDER-COATED		
Length 1 3/8 feet Pack: 5 pcs.		
h/in.	Part no.	\$/pack
4	ZBL640-4591	76.11

ALUMINUM OLD COPPER BROWN, POWDER-COATED		
Length 1 3/8 feet Pack: 5 pcs.		
h/in.	Part no.	\$/pack
4	ZBL640-4581	76.11

ALUMINUM STAINLESS STEEL METALLIC, POWDER-COATED		
Length 1 3/8 feet Pack: 5 pcs.		
h/in.	Part no.	\$/pack
4	ZBL640-4502	78.42

CORNER JOINER 90°, OUTER DIMENSION 9 1/2" · 9 1/2"



ALUMINUM 90° MEDIUM GRAY, POWDER-COATED		
Pack: 1 pc.		
h/in.	Part no.	\$/pc.
4	ZBL641-4591-090	91.99

ALUMINUM 90° OLD COPPER BROWN, POWDER-COATED		
Pack: 1 pc.		
h/in.	Part no.	\$/pc.
4	ZBL641-4581-090	91.99

ALUMINUM 90° STAINLESS STEEL METALLIC, POWDER-COATED		
Pack: 1 pc.		
h/in.	Part no.	\$/pc.
4	ZBL641-4502-090	94.70



ALUMINUM, NATURAL

Thanks to the wide range of material surfaces in the product systems, you will find the right design for every requirement and every taste. However, there are differences in the properties of the various surface options. For example, untreated aluminum has limited use indoors with low mechanical load. It oxidises and should be thoroughly cleaned after grouting. Not every grout or adhesive is compatible with aluminum, so the following basic principle applies: Before installation, you must check that the products used are compatible with aluminum.

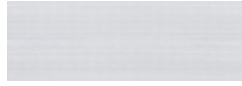

NATURAL - 400

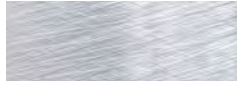

ALUMINUM LOOK,
CROSS BRUSHED
SHINY SILVER

ALUMINUM, ANODIZED

Anodized aluminum can be used inside at low mechanical stress. Not recommended for commercial floor applications because the silver/gold finish can be scratched or worn-off by heavy traffic. By deforming (bending) anodized aluminum there may be slight changes in color.



SATIN GOLD - 42O



SHINY GOLD - 48O



BRONZE



ROYAL CHAMPAGNE - 47O



SATIN SILVER - 41O



SHINY SILVER - 43O



TITANIUM BRONZE - 446



MATTE BLACK - 416



SILVER CROSS BRUSHED



BRUSHED NICKEL - 42OB



OIL RUBBED BRONZE

ALUMINUM, POWDER-COATED

The aluminum profiles go through several stages of pre-treatment, then they are powder coated and fired. This gives the profiles a high quality protective coating, which can also come in a range of different colours. The high regularity of shape, value and protective function of the acrylic coat-ed surfaces thus offer a number of additional functions. However the profiles are not mechanically strong which must be considered during processing.



OLD COPPER BROWN



BROWN

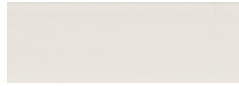

JASMINE



MANHATTAN GRAY



GRAY

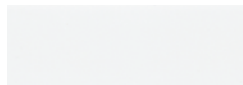

WHITE .450



STAINLESS STEEL METALLIC



GRAPHITE BLACK

ALUMINUM, TEXTURED POWDER-COATED

The aluminum profiles go through several stages of pre-treatment, then they textured powder-coated and fired.



SAND TROPEZ

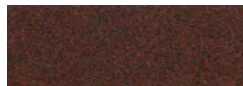

OXIDE



GRAPHITE



STONE GRAY



QUARTZ



OYSTER WHITE



INDUSTRIAL RUST



COAL BLACK



DARK CHOCOLATE



SUGAR WHITE

ALUMINUM, BRUSHED ANODIZED

Anodized aluminum can be used indoors where there is little mechanical loading. The anodized layer largely protects against oxidation. After installation with mortar or adhesive, residue should always be removed immediately, otherwise the surface could be stained. Anodized surfaces are very easily scratched. Be careful when installing. During bending work with anodized aluminum some slight discoloration may occur.



SATIN SILVER



SILVER, CROSS BRUSHED



ROYAL CHAMPAGNE



TITANIUM BRONZE - 446



MATTE BLACK



SATIN GOLD

BRASS

Solid brass can be used inside and outside and is mechanically strong and stressable. Recommended for floors exposed to heavy loads (i.e. forklifts and heavy stocking carts). Exposure to moisture may cause a slight tarnishing which can be removed by polishing. Ideal for residential and commercial applications where traffic loads are light to moderate and extruded brass is more than the budget will allow. Also, provides a very attractive accent to complement polished



POLISHED



NATURAL - 300



CHROME-PLATED - 340

CHROME-PLATED

Generally speaking, chrome surfaces show good load capacities. After installing, immediately remove adhesive and grout residues. To maintain a high-quality appearance for years to come, protect chrome-plated surfaces from scratching or exposure to grit and rough contact. Do not use abrasive cleaners that contain hydrochloric, formic or acetic acids. Cleaners containing hydrofluoric acid or chlorine bleach should never be used. Citric acid or sulfamic acid that are compatible with the material can be used for cleaning. Generally speaking, after cleaning rinse the surface with abundant clean water.

BRASS,
CHROME-PLATEDSTAINLESS STEEL,
CHROME-PLATED

STAINLESS STEEL

Made by roll-forming 0.8 mm thick stainless steel. Highly recommended for commercial applications with strict sanitary requirements and where surfaces are exposed to strong chemicals and high mechanical stress (i.e. hospitals, food processing facilities, commercial kitchens and swimming pools).



STAINLESS STEEL/
(ACID-RESISTANT/AISI 316) - 285



POLISHED



BRUSHED - 280B



STAINLESS STEEL LOOK



STAINLESS STEEL LOOK,
POLISHED - 286



STAINLESS STEEL LOOK,
BRUSHED



CHROME-PLATED - 284O



CROSS BRUSHED

PVC

In the interior plastic can be used at low stress. The plastic is made of completely coloured UV resistant PVC in different color shades.



ANTHRACITE



BAHAMA BEIGE - 5071



SILVER GRAY - 5092



GRAPHITE BLACK - 5006



GRAY - 509



BEIGE



LIGHT GRAY



JASMINE - 2011



MANHATTAN GRAY - 5091



BROWN - 508



MEDIUM GRAY

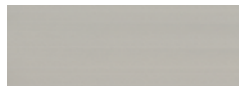

SAND GRAY



BLACK

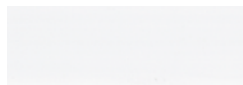

WHITE - 501

COMMON COLOR/ FINISH CODES *

300 - Brass, natural
 340 - Brass, chrome plated
 280 - Stainless steel, natural
 280B - Stainless steel, brushed
 2840 - Stainless steel, chrome plated
 285 - Stainless steel, acid-resistant/AISI 316
 286 - Stainless steel, polished
 400 - Aluminum, natural
 410 - Aluminum, satin silver, anodized
 416 - Aluminum, matte black, anodized
 420 - Aluminum, satin gold, anodized
 420B - Aluminum, brushed nickel, anodized
 430 - Aluminum, shiny silver, anodized
 446 - Aluminum, titanium bronze, anodized
 450 - Aluminum, white, powder-coated
 456 - Aluminum, black, powder-coated
 470 - Aluminum, royal champagne, anodized
 480 - Aluminum, shiny gold, anodized
 501 - PVC, white
 506 - PVC, graphite black
 508 - PVC, brown
 509 - PVC, gray
 5011 - PVC, jasmine
 5071 - PVC, bahama beige
 5091 - PVC, manhattan gray
 5092 - PVC, silver gray

HEIGHT CONVERSION CHART (IN. - MM)

1/32"- 0.8	17/32"- 14.0
1/17"- 1.5	19/32"- 15.0
1/16"- 2.0	5/8"- 16.0
1/8"- 3.0	3/4"- 18.5
3/16"- 4.5	13/16"- 20.0
1/4"- 6.0	7/8"- 22.0
9/32"- 7.0	31/32"- 23.0
5/16"- 8.0	1"- 25.0
11/32"- 9.0	13/16"- 30.0
3/8"- 10.0	13/5"- 40.0
7/16"- 11.0	29/25"- 60.0
1/2"- 12.5	

* Additional colors/finishes available - please refer to catalog for details.

PART NUMBER IDENTIFICATION SYSTEM

Tile trims have specific part numbers made up of three components that notate important information such as the shape, finish, and size of each trim. To better understand this identification system, please refer to the following examples.

EXAMPLE 1:

PART NO. ZBL300-410-10025

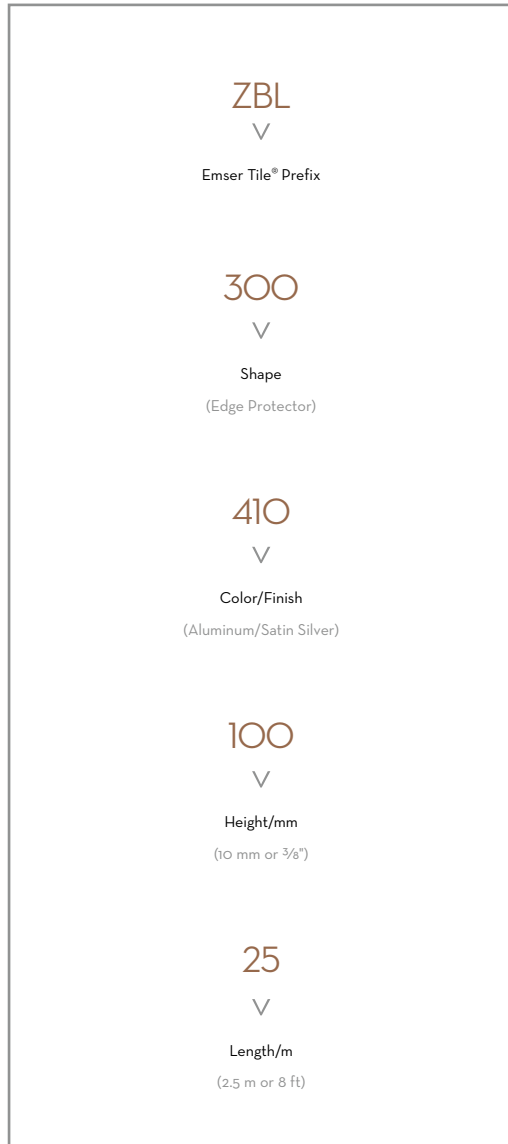

EXAMPLE 2:

PART NO. ZBL347-501-12525

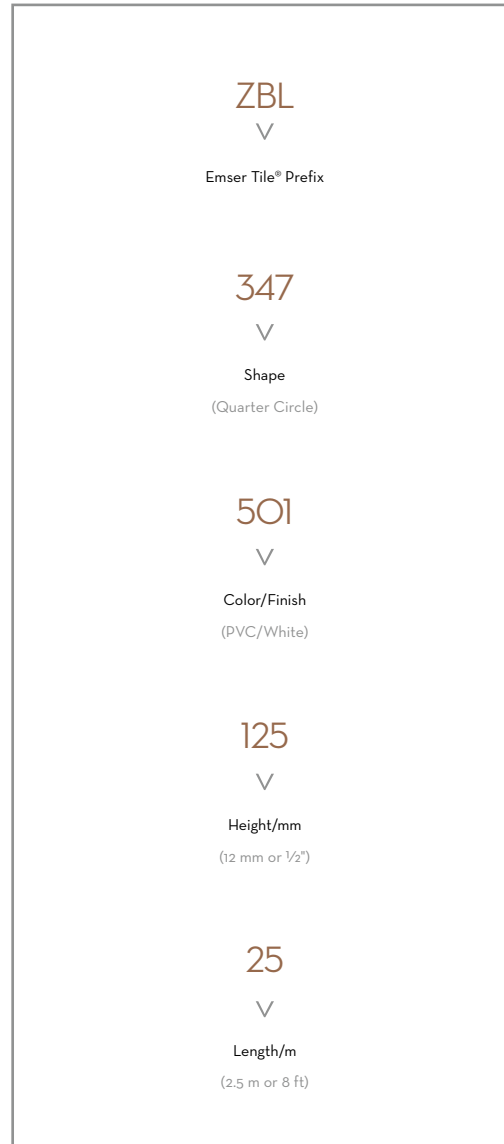

FREIGHT AND SHIPPING CHARGES:

Orders under \$1350 shipping to customer may be subject to a freight charge. Next day air is not available on Signature Series, but other expedited freight may be available at the customers expense if required. Check with your Emser Tile representative for details.



SHOWER

Esplanade | Alley
Limestone | Cream Honed Leaf Mosaic
Vogue | White

FLOOR

Hollywood | Beige
Limestone | Cream Honed Leaf Mosai