



USER MANUAL

WELCOME TO THE FAMILY

Thank you for choosing to grow with Kind LED! We are committed to providing you with the highest quality grow lights and industry leading customer support. If you have any questions regarding the set up or operation of your new Kind LED Grow Light, our customer service team is ready to help.



X750 DRIVER INSTALLATION VIDEO



GROW STRONG SUPPORT

Phone: 1-855-448-4769

Web: support.growstrongindustries.com

TABLE OF CONTENTS

OVERVIEW	3
COMPONENTS	4
SET UP X220 X330 X420	5
SET UP X750	6
BEST PRACTICES	7

OVERVIEW

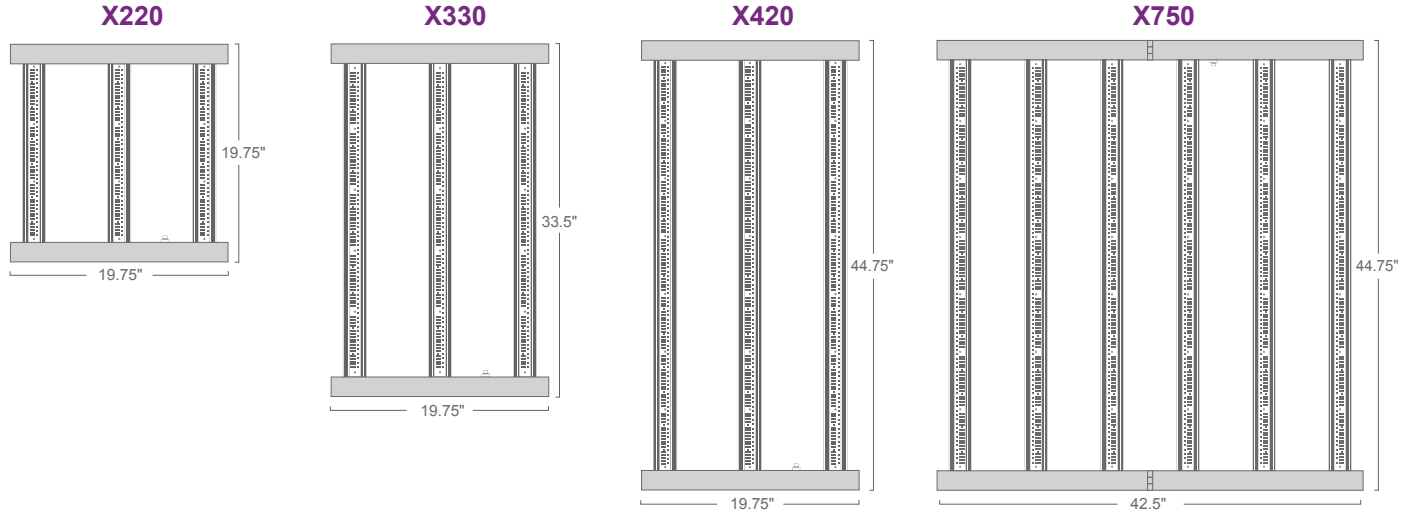

SPECIFICATIONS

	X220	X330	X420	X750
Spectrum	2 Channel	2 Channel	2 Channel	2 Channel
Efficacy	2.55umol/J	2.55umol/J	2.55umol/J	2.55umol/J
PPF	561umol/s	841umol/s	1071umol/s	1730umol/s
Max Wattage	220 +/- 5%	330 +/- 5%	420 +/- 5%	750 +/- 5%
Input Voltage	120-277V	120-277V	120-277V	120-277V
Lifetime	100,000 Hrs.	100,000 Hrs.	100,000 Hrs.	100,000 Hrs.
Dimensions	19.75" x 19.75"	19.75" x 33.5"	19.75" x 44.75"	42.5" x 44.75"
Cord Length	6'	6'	6'	6'
RMH	+/- 12"	+/- 12"	+/- 12"	+/- 12"
Warranty	5 Year	5 Year	5 Year	5 Year
Certifications	FCC, ETL	FCC, ETL	FCC, ETL	FCC, ETL

PROFILE



COMPONENTS

X220



6 ft. 120V Power Cord



12 in. DC Output Cord

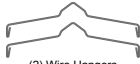

(2) Wire Hangers



(2) Yo-Yo Ratchet Hangers



RJ-14 Data Cable



Driver

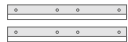

(2) Driver Mounting Brackets



8 ft. DC Output Extension
(SOLD SEPARATELY)

X330



6 ft. 120V Power Cord



12 in. DC Output Cord

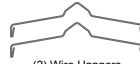

(2) Wire Hangers



(2) Yo-Yo Ratchet Hangers



RJ-14 Data Cable



Driver



(2) Driver Mounting Brackets



8 ft. DC Output Extension
(SOLD SEPARATELY)

X420



6 ft. 120V Power Cord



16 in. DC Output Cord

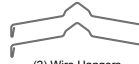

(2) Wire Hangers



(2) Yo-Yo Ratchet Hangers



RJ-14 Data Cable



Driver

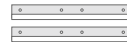

(2) Driver Mounting Brackets



8 ft. DC Output Extension
(SOLD SEPARATELY)

X750



6 ft. 120V Power Cord



10 in. DC Output Cord



(4) Yo-Yo Ratchet Hangers



RJ-14 Data Cable



Driver

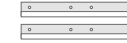

(2) Driver Mounting Brackets



X750 8 ft. DC Output Extension
(SOLD SEPARATELY)

SET UP X220 | X330 | X420

- 1 The X220, X330, & X420 X Series come fully assembled, ready to grow. Unpack the fixture and place the light on a safe and stable area directly below the desired hanging location.

CAUTION: The LED boards have a conformal coating to resist moisture, but are vulnerable to diode damage if handled improperly. Please make sure LED surfaces are protected from abrasion while handling.

- 2 Attach one wire hanger to each end of the fixture through the metal mounting eyelets found on the top side of the fixture.

Lower the ratchet hangers to the center of the wire hanger and connect. Raise the light to the desired position.

- 3 The X Series driver can be mounted remotely with the 8 ft. driver extension cord (sold separately).

1. Disconnect the DC output cord from the fixture, leaving it connected to the driver
2. Using a Phillips-head screwdriver, remove the four (4) screws connecting the driver to the driver mounting brackets
3. Securely mount the driver in its new location
4. Connect the DC output extension from the fixture to the open end of the DC output cord

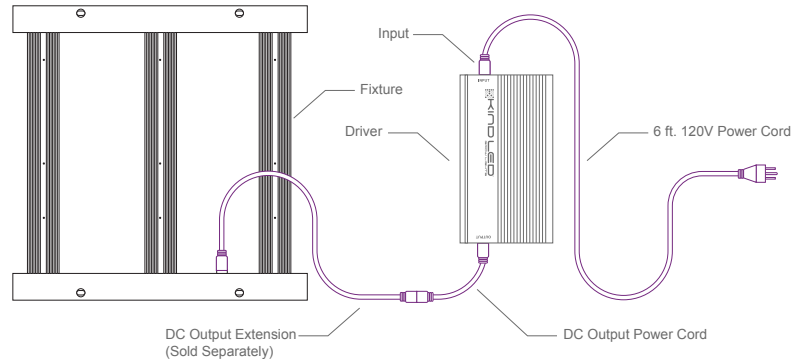
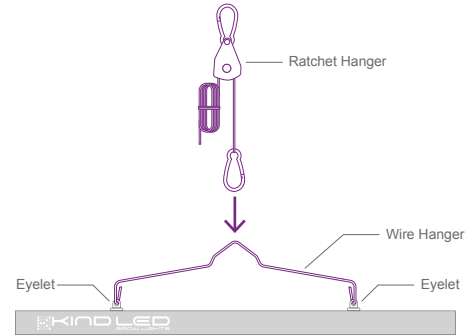

SET UP X750

- 1** Unpack, unfold, and place the fixture on a safe and stable area directly below the desired hanging location.

CAUTION: The LED boards have a conformal coating to resist moisture, but are vulnerable to diode damage if handled improperly. Please make sure LED surfaces are protected from abrasion while handling.

- 2** Locate the driver mounting brackets. Use the flat head screws to attach the brackets to the fixture. Use the round head screws to mount the driver to the brackets.



Flat head screw - Bracket to fixture



Round head screw - Driver to bracket

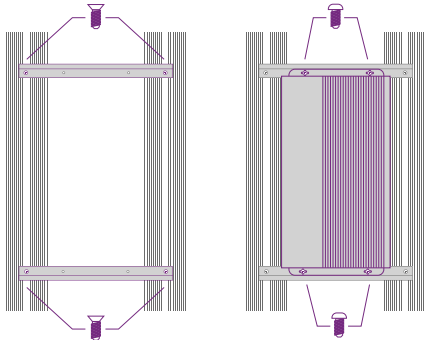

- 3** Attach the DC output cord from the driver connection marked "Output" to the two connection points on the fixture. Attach the 120v power cord to the driver connection marked "Input."

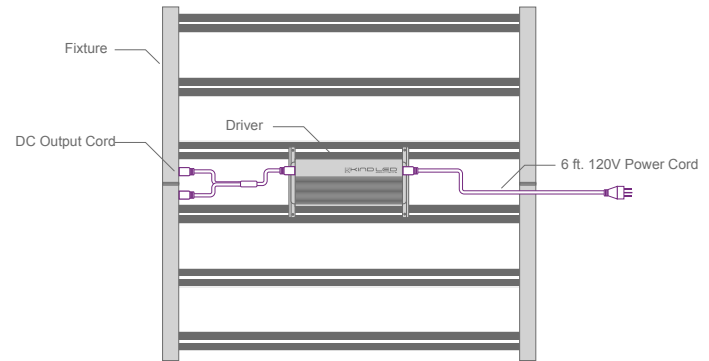

- 4** Lower the yo-yo ratchet hangers to each metal mounting eyelet found on the top side of the fixture. Raise the light to the desired position.

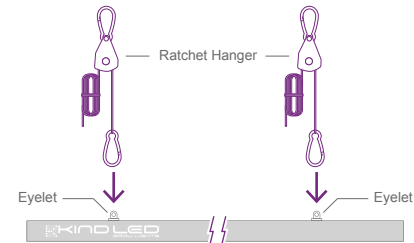

BEST PRACTICES

SPECTRUM ADJUSTMENT

The spectrum and intensity of the light can be manually controlled through the rotary dials on the front of the driver.

Channel 1 is a targeted full spectrum channel and should always be on. Intensity of this channel will vary for clones, seedlings, and younger plants.

Channel 2 contains the IR and UV, as well as some additional deep reds, for an enhanced flowering spectrum.

Please see the chart for recommended intensity levels.

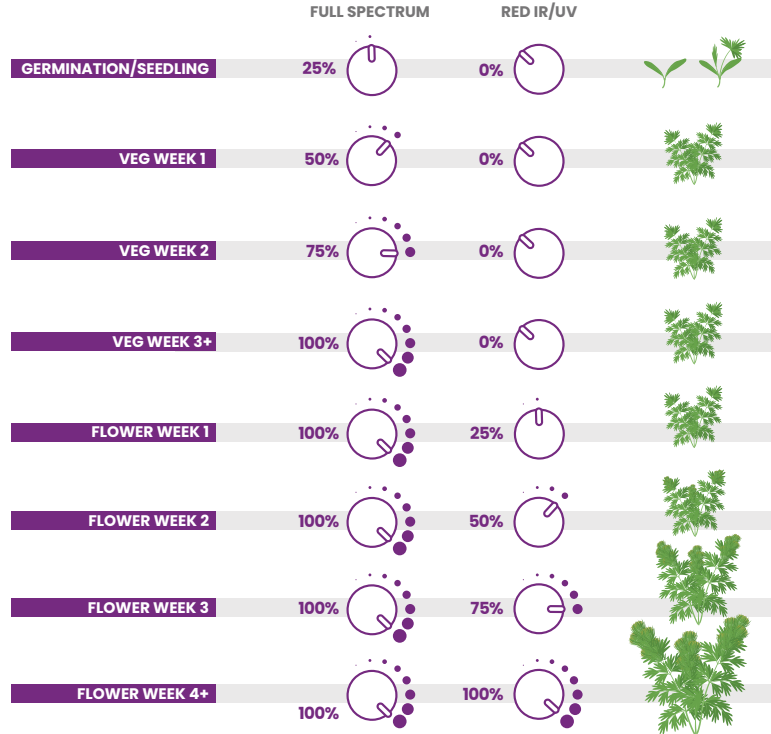
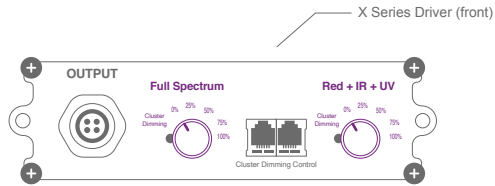

BEST PRACTICES

ENVIRONMENT

When using the Kind LED X Series, ideal grow room temperature should be 80-85°F. Temperatures lower than the recommended range can slow transpiration, stunting growth. Temperatures higher than the recommended range can cause heat stress to the plant.

NOTE: High PPFd growing conditions require high levels of attention to detail including proper feeding and CO2 augmentation. For more information, please visit kindledgrowlights.com

RECOMMENDED HANGING HEIGHT

The Kind LED X Series designed to excel in close proximity environments but can be used in a variety of applications.

In most applications, a recommended hang height of 12"-18" above canopy is ideal.

For applications that require less intensity, such as Seedling, Cloning, and Early Vegetative Stages, a hang height greater than 18" above canopy may be suitable.

*ADVANCED GROWING PRACTICES

For growing practices that include CO2 augmentation, expert attention to feeding practices and nutrient levels, and a rigid adherence to environmental factors, a minimum hang height of 6"-12" can be achieved. This hang height represents highly elevated PPFd intensity levels and requires care across all elements of the growing process.



6"-12" Advanced Growing Practices*

Distance To Canopy

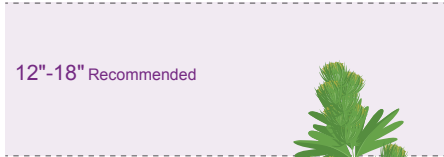

12"-18" Recommended

18"-24" Seedlings, Clones & Early Vegetation



YOU'RE READY TO GROW STRONG

For more information on this fixture and all available options, contact a Kind LED Grow Lights customer service representative at kindledgrowlights.com or call (855) 448-4769.



**WE WANT TO SEE YOUR GROW!
FOLLOW & TAG US ON INSTAGRAM:**

@kindledgrowlights #kindledgrowlights



**LEARN MORE ABOUT THIS LIGHT
& OTHER PRODUCTS:**

kindledgrowlights.com

FCC COMPLIANCE STATEMENT

The Kind LED X Series lighting system has been tested at FCC-certified laboratories in the United States and conforms to FCC's Part 15B Consumer Standard for Industrial, Scientific, and Medical Equipment for both conducted and radiated emissions.

Given that all electronic equipment emits some RF energy, please note that compliance with these standards does not mean a zero level of emission, only very low levels.

Per FCC requirement: This product may cause interference to radio equipment and should not be installed near Maritime safety communications equipment or other critical navigation or communication equipment between 0.45-30 MHz. This device complies with Part 15B of the FCC Rules.

Changes or modifications not expressly approved by Kind LED could void the user's authority to operate the equipment.

Please visit www.KindLEDGrowLights.com for a complete documentation of the Kind LED Lighting Terms of Use. Thank You.



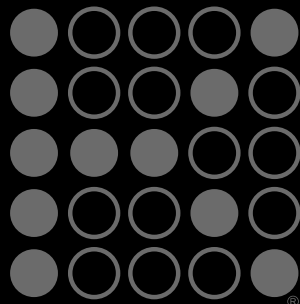

KINDLED®
GROW LIGHTS