

pewag winner profilift lifting points

Lifting and lashing



Hardened shell –
intelligent core

peTAG solution



Watch out!
More about the intelligent core
on pages 10 and 11.

Content

Screwable and weldable lifting points from pewag.

pewag winner profilift lifting points stand for premium quality and advanced innovation that set new standards within the chain industry when it comes to lifting and moving loads. As an ideal addition to the successful pewag winner lifting chain assortment, the pewag winner profilift lifting points ensure a high degree of safety, user-friendliness and compatibility, combined with easy-to-use designs and outstanding quality features.

pewag group	
Introduction of the pewag group	4-5
History and quality management	6
Business areas and the environment	7
Locations	8
peTAG solution	
peTAG solution	10-11
Overview page	
Overview page screwable and weldable lifting points, anchorage points	12-13
Screwable lifting points	
Screwable lifting points	14-41
Weldable hooks and lifting points	
Weldable hooks and lifting points	42-49
Anchorage points - Fall protection	
Anchorage points - Fall protection	52-55
Spare parts	
Spare parts	56-61
User information	
User information	62-65
Notes	66



Welcome to the pewag group

We are an internationally operating group of companies. Our track record goes back to the year 1479.

Mission Statement

pewag group's Mission Statement expresses the goals of our actions as follows:

With our joy for innovation, we strive to make all products of the pewag group the best in the respective markets. The high quality of our products and services as well as our employees' passionate dedication are the foundation to our pursuit of outstanding services and complete customer satisfaction.

Principles of pewag group

Leading in Quality

The values of our product brands are demonstrated by our first-class quality and innovations and are communicated consistently and coherently.

We anticipate market demands and changes in the environment and adapt our strategies, organizations and actions accordingly to satisfy our customers' needs through providing an optimal price-performance ratio: timely delivery, efficient and obliging service.

Leading in Responsibility

We commit ourselves to careful treatment of the environment, by reducing the use of energy and raw materials, ensuring the longevity of our products and making them recyclable.

We value an open, honest and team-oriented work-style, which is based on transparent communication honoring ideas, opinions and experience of our employees as valuable inputs for our decision making process.

We strive for stable and fair partnerships with our employees, customers, suppliers and other business partners and take social aspects into consideration when making business decisions.

Leading in Technology

We secure our technological strength by striving for product quality, constant improvements and innovations of products, as well as manufacturing processes.

We strive to be the best in product technology. This ensures that our customers always have optimal solutions available and that we expand and protect our market position.

Leading in Economics

In all our processes we use due diligent business practices and efficiency and strive to improve these continuously.

In the long-term, we will continuously increase our economic performance to raise corporate value, achieve sustained growth and thus secure a successful future of the organization.

We are a modern group of companies which looks back to a tradition and experience of more than 500 years. Since our founding years, a lot has changed, but the values that made our success possible from the beginning remain.

**pewag group –
Innovation. Quality. Partnership.**

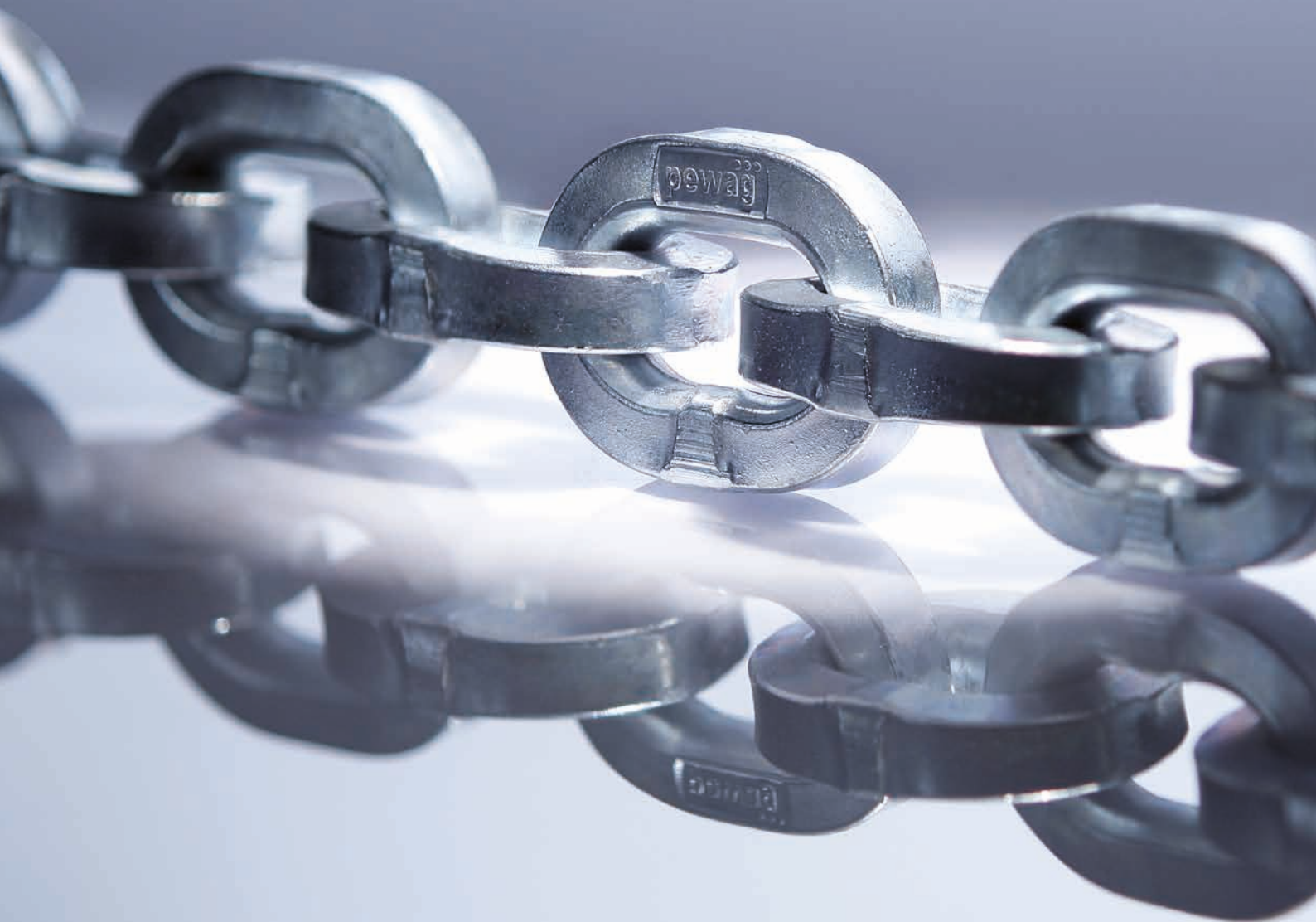

History of the pewag group

Quality management

Advantage through tradition

The history of pewag group goes back to the 15th century and therefore makes us one of the oldest chain manufacturer worldwide. With our experience we are ready for the future.

Timetable of important events

- 1479** First documented references of a forging plant in Brückl
- 1787** Foundation of a chain forge in Kapfenberg
- 1803** Foundation of a chain forge in Graz
- 1836** Establishment of an iron casting plant in Brückl
- 1912** Production of the first pewag snow chain
- 1923** Merger of plants in Graz and Kapfenberg – Creation of the name “pewag”
- 1972** Foundation of a sales company in Germany
- 1975** Foundation of a sales company in the USA
- 1993** Foundation of pewag austria GmbH
- 1994** Foundation of the first subsidiary in Czech Republic
- 1999** Acquisition of the Weissenfels Group
- 2003** Separation from the Weissenfels Group
- 2005** Reorganization into 2 groups:
Schneeketten Beteiligungs AG Group – Snow Chains
pewag austria GmbH Group – Technical Chains
- 2009** Acquisition of Chaineries Limousines S.A.S.
- 2012** Foundation of the first manufacturing company in the USA
- 2013/** Foundation of various international sales
- 2014** companies



Lithography forging plant Brückl 1855



Anchor chain forge 1878



Chain forgers 1956

Our main goal is customer satisfaction.

In this instance, quality means that only those products and services are developed, manufactured and delivered which completely and without compromise satisfy the customer.

The pewag group’s quality policy, is underlined by the following basic principle: **“we supply high-end products and services to our customers that conform to the technical standards and requirements”**, can be summarised in the subsequent four points.

Market-oriented Quality

In order to maintain and to widen the competitive position of the pewag group, the quality of finished goods and services must be consistent with the specifications of the customer and also with their expectations of one of the leading companies. No product should ever pose a danger to people or the environment.

Economic Quality

As a profit-oriented company, quality is achieved by taking into consideration the material, personnel and financial resources; this means that we establish an appropriate best price/performance ratio for the customer within the acknowledged framework.

Quality Responsibility

Stringent demands are placed on all employees to ensure high standards of quality. No matter what hierarchical level, all managers are in charge of managing quality. Every employee within the pewag group should be educated, motivated and instructed by the management team. It is important for promoting high quality awareness that the education and training of employees is at the forefront, as each employee is responsible for the quality of his/her own work.

For each of our employees, the statement **“QUALITY STARTS WITH ME”** must be true!

Process-oriented Quality

The close interaction between sales, product development, production and customer service is regulated within the individual companies by fixed processes and activities, as well as responsibilities with the aim to reach and maintain the defined quality standards.



Business areas

Environment – we take responsibility

Working with pewag products

The pewag group has a substantial and diverse spectrum of products and services.

Our range of products varies from traction chains for tires (snow chains for passenger cars, trucks and special-purpose vehicles, tire protection chains for mining vehicles) over different industrial chains to products for the do-it-yourself sector (light chains, belts, etc.)



Segment A
Snow and forestry chains



Segment B
Hoist and conveyor chains



Segment C
Do-it-yourself



Segment D
Engineering



Segment F
Lifting and lashing chains and accessories



Segment G
Tire protection chains

Ecological awareness in all areas



Our company's manufacturing location in Kapfenberg, Austria, has been used for iron and steel production for over 270 years. A second facility located in Brückl, Austria, was first documented in records dating back to 1479.

Based on this long manufacturing tradition, we take serious responsibility for our products, employees and the environment at all our international locations. Hence, one of our major concerns is to improve energy efficiency and, in doing so, to minimise energy consumption over a long period of time with the development of new production technologies. An important goal is to increase energy efficiency and consequently lower energy demand. Consequently, we develop our products to achieve longer product life-cycles and lower weight but simultaneously, increasing their working load capacities and the safety for our customers. We are committed to upholding all relevant energy and environmental standards by setting clearly defined goals and continually improving our performance. To achieve this goal, we use modern manufacturing technologies. An important step is to provide the necessary resources and to include our employees in the process. We are convinced that well-informed and motivated employees can actively participate in environmental conservation.

Wherever we are unable to avoid an environmental impact, we have set ourselves the goal to continually reduce our energy consumption, waste and environmentally harmful emissions. When purchasing new equipment, we strive to find the best and most efficient technical solution possible. It is important for us to promote the purchase of energy efficient products and services.

Our process-oriented management system regulates the documentation concerning all environmental relevant procedures. It also encompasses preventative measures for possible failures, as well as behavioural instructions for regular and/or extraordinary operational procedures. By systematically monitoring and assessing our environmental activities, we are quickly able to resolve deviances and to take corrective action. This process extends throughout the whole organisation to optimise all business processes. We strive to engage in an open dialogue with our customers, neighbours and authorities to inform them of our energy and environmental engagements.

Through specific communication we want to inform our customers about the environmental aspects of our products – specifically inform them about the longevity of our products. Through meaningful communication, we strive to motivate our suppliers and customers to think – in turn – about their environmental footprint and to put into practice similar environmental standards in their businesses.

Customer proximity

International presence

In the ambitious five-hundred year history pewag has evolved from a small and modest company to a global organization with several subgroups.

With 12 production and 40 sales and other locations on all five continents, pewag documented its claim as one of the world's leading chain manufacturers.

In addition to the numerous locations pewag as an international company relies on his capillary, strong, and professional partner network. These collaborations provide optimal customer service in currently more than 100 countries around the world.

Production and sales locations

Europe

Austria	pewag austria GmbH, Graz pewag austria GmbH, Kapfenberg pewag Schneeketten GmbH, Graz pewag Schneeketten GmbH, Brückl pewag engineering GmbH, Kapfenberg pewag austria Vertriebsgesellschaft mbH, Graz pewag Ketten GmbH, Klagenfurt pewag International GmbH, Klagenfurt
Germany	pewag Deutschland GmbH, Unna pewag Schneeketten Deutschland GmbH, Unna
France	pewag france SAS, Echirolles / Grenoble Chaineries Limousines SAS, Bellac
Italy	pewag italia srl, Andrian
Croatia	pewag d.o.o, Rijeka
The Netherlands	pewag nederland BV, Rijnsburg APEX International BV, Hillegom APEX Automotive BV, Hillegom
Poland	pewag polska Sp. z o.o., Buczkowice
Portugal	pewag Portugal – Comercio de Produtos e Equipamentos Industriais, Lda, Santo Antão do Tojal
Romania	pewag Romania SRL, Sibiu County
Russia	OOO "PEWAG", Moscow
Sweden	pewag sweden AB, Emmaboda
Slovakia	pewag Slovakia sro, Nováky
Czech Republic	pewag Czech sro, Vamberk Řetězárna Česká Třebová sro, Vamberk pewag sro, Vamberk pewag Czech sro, Česká Třebová peform Chrudim sro, Chrudim

Europe

Ukraine	TOV pewag Ukraine GmbH, Lviv
---------	------------------------------

North America

USA	pewag Inc, Bolingbrook, Illinois pewag Inc, Rocklin, California pewag Traction Chain Inc, Pueblo, Colorado
Canada	pewag Canada Inc., Mississauga
Mexico	pewag Mexico SA de CV, Mexico

South America

Brazil	Helevar Comércio e Importação de Produtos Metalúrgicos Ltda., Porto Alegre
Colombia	pewag Columbia S.A.S, Medellin

Africa

South Africa	pewag chain south africa (pty) ltd., Rivonia
--------------	--

Australia

Australia	pewag australia Pty Limited, Barrack Heights
-----------	--

Asia

India	pewag India Private Limited, Bangalore
-------	--

pewag group presents
itself on the internet. More ...

www.pewag-group.com

www.pewag.com

pewag group –
Innovation. Quality. Partnership.



pewag chains together

The peTAG solution enables cross-company, flexible servicing and administration of a wide range of different objects.

peTAG solution

The intelligent solution for unambiguous object identification, data transfer without media breaks, easy servicing of objects, safe document archiving, efficient interaction with partner businesses and much more.

peTAG info

Smart, free-of-charge access to product-specific information via mobile web.

peTAG manager

Watch your PC and mobile devices work hand in hand with this adaptable, high-performance platform – in any work environment and while increasing data quality at the same time. Expensive add-on reading devices and manual data transfer are things of the past!



pewag profilit lifting points PLGW, PLAW, PLBW and PLDW have a standard prefabrication for transponders (Ø 4 mm).

peTAG solution

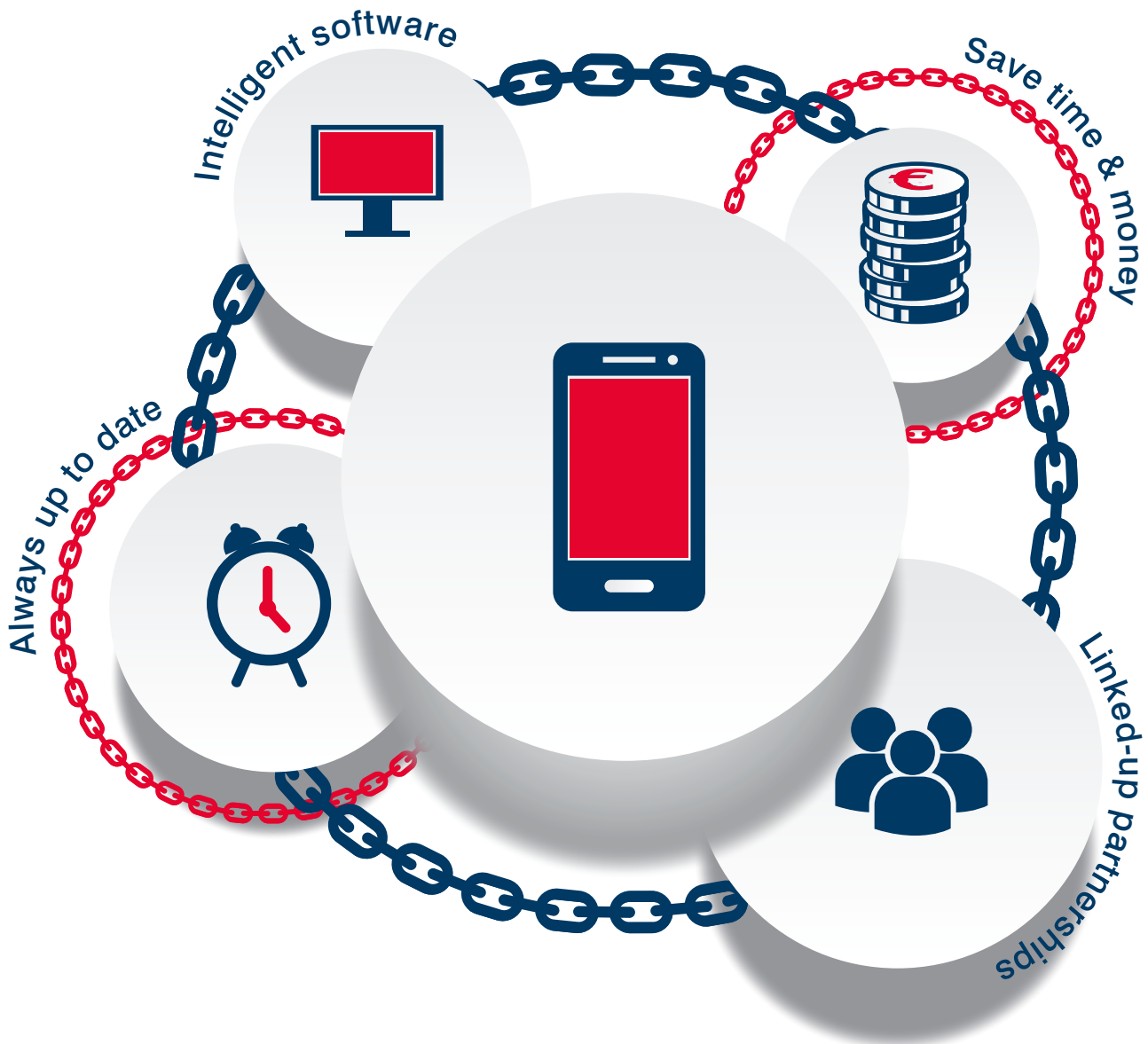

peTAG solution Keyfacts



Intelligent software

User-specific adaptation of object data, testing processes and steps. Automates the creation, sending and archiving of test reports. Sophisticated authorisation concept.



Save time & money

Efficient documentation of work processes, thus simplified daily workflows. Data exchange without media breaks, fault-free data communication.



Mobile solution

Direct, location-independent data access (e.g. load capacity, safety information, latest test reports etc.) Smart servicing of objects via mobile app. Offline availability.



Linked-up partnerships

Straightforward exchange and efficient interaction between service providers, merchants and customers. Improved service and data quality. Increased satisfaction and loyalty.



Always up to date

Access to the latest product data and information, overview of all test data, documentation of test procedures. Traceability of object history.



Screwable lifting points – uplifting variety

Variety has a name: pewag! The pewag profilift portfolio offers high-quality products perfectly suitable for nearly every lifting purpose.

PLGW Eyebolt	Code	Thread [mm]	Load capacity [kg]
	PLGW 0,3 t	M8	300
	PLGW 0,5 t	M10	500
	PLGW 0,7 t	M12	700
	PLGW 1,5 t	M16	1,500
	PLGW 2,3 t	M20	2,300
	PLGW 3,2 t	M24	3,200
	PLGW 4 t	M30	4,000
	PLGW 4,9 t	M30	4,900
	PLGW 7 t	M36	7,000
	PLGW 9 t	M42	9,000
	PLGW 12 t	M48	12,000

PLGW-SN Supreme screw nut	Code	Thread [mm]	Load capacity [kg]
	PLGW-SN 0,3 t	M8	300
	PLGW-SN 0,5 t	M10	500
	PLGW-SN 0,7 t	M12	700
	PLGW-SN 1,5 t	M16	1,500
	PLGW-SN 2,3 t	M20	2,300
	PLGW-SN 3,5 t	M24	3,500
	PLGW-SN 4,9 t	M30	4,900

PLGWI Eyebolt	Code	Thread [mm]	Load capacity [kg]
	PLGWI 2 t	M20	2,000

Please refer to the table on the PLMS product page to find the pitch values of the thread.

PLAW Alpha	Code	Thread [mm]	Load capacity [kg]
	PLAW 0,3 t	M8	300
	PLAW 0,63 t	M10	630
	PLAW 1 t	M12	1,000
	PLAW 1,5 t	M16	1,500
	PLAW 2,5 t	M20	2,500
	PLAW 4 t (/13)	M24	4,000
	PLAW 6 t	M30	6,000
	PLAW 7 t	M36	7,000
	PLAW 8 t	M36	8,000
	PLAW 10 t	M42	10,000
	PLAW 15 t	M42	15,000
	PLAW 20 t	M48	20,000

PLBW Beta	Code	Thread [mm]	Load capacity [kg]
	PLBW 0,3 t	M8	300
	PLBW 0,6 t	M10	600
	PLBW 1 t	M12	1,000
	PLBW 1,3 t	M14	1,300
	PLBW 1,6 t	M16	1,600
	PLBW 2 t	M18	2,000
	PLBW 2,5 t	M20	2,500
	PLBW 3 t	M22	3,000
	PLBW 4 t	M24	4,000
	PLBW 5 t	M27	5,000
	PLBW 6,3 t	M30	6,300
	PLBW 8 t	M33	8,000
	PLBW 10 t	M36	10,000
	PLBW 12,5 t	M42	12,500
	PLBW 15 t	M48	15,000

PLDW Delta	Code	Thread [mm]	Load capacity [kg]
	PLDW 0,3 t	M8	300
	PLDW 0,5 t	M10	500
	PLDW 0,7 t	M12	700
	PLDW 1 t	M14	1,000
	PLDW 1,5 t	M16	1,500
	PLDW 2,5 t	M20	2,500
	PLDW 4 t	M24	4,000
	PLDW 6,7 t	M30	6,700
	PLDW 8 t	M36	8,000
	PLDW 10 t	M42	10,000
	PLDW 12 t	M45	12,000
	PLDW 12,5 t	M48	12,500
	PLDW 24 t	M56	24,000
	PLDW 25 t	M64	25,000

AOR Lashing point	Code	Thread [mm]	Load capacity [kg]
	AOR 10	M16	3,150
	AOR 13	M20	5,300
	AOR 16	M30	8,000
	AOR 22	M36	15,000
	AOR 26	M42	21,200
	AOR 28	M45	25,000
	AOR 32	M56	31,500
	AOR 34	M56	36,000

RGS Eyebolt	Code	Thread [mm]	Load capacity [kg]
	RGS 8	M8	400
	RGS 10	M10	700
	RGS 12	M12	1,000
	RGS 14	M14	1,200
	RGS 16	M16	1,500
	RGS 18	M18	2,000
	RGS 20	M20	2,500
	RGS 22	M22	3,000
	RGS 24	M24	4,000

Weldable hooks and lifting points

AWHW Weld-on hook	Code	Load capacity [kg]
	AWHW 1,3	1,300
	AWHW 3,8	3,800
	AWHW 6,3	6,300
	AWHW 10	10,000

PLE/N Eta	Code	Load capacity [kg]
	PLE/N 6	1,120
	PLE/N 8	2,000
	PLE/N 10	3,150
	PLE/N 13	5,300
	PLE/N 16	8,000
	PLE/N 22	15,000

PLEW Eta	Code	Load capacity [kg]
	PLEW 1,5 t	1,500
	PLEW 2,5 t	2,500
	PLEW 4 t	4,000
	PLEW 6,7 t	6,700
	PLEW 10 t	10,000
	PLEW 19 t	19,000

Anchorage points – Fall protection

PLGW-PSA Fall protection	Code	Persons
	PLGW PSA M12	1
	PLGW PSA M16	2
	PLGW PSA M20	2

Please refer to the table on the PLMS product page to find the pitch values of the thread.

Screwable lifting points

Product overview

Content

Benefits at a glance	16-17
PLGW pewag winner profilift gamma	18-21
PLGW-SN pewag winner profilift gamma supreme Ring nut	22-23
PLGWI pewag winner profilift gamma inox	24-26
PLGW in comparison: game, set and match	27
PLAW pewag winner profilift alpha	28-31
PLBW pewag winner profilift beta	32-35
PLDW pewag winner profilift delta	36-39
AOR Lashing point	40
RGS Eyebolt	41





pewag innovation: safe as houses

Lifting and lashing: the highest level of safety for operating staff and transported goods

Premium Austrian chain manufacturer pewag is deservedly proud of its outstanding reputation for innovation, quality and safety. The company's expertise in setting new standards goes back centuries – and lifting points are no exception. In fact, pewag has long been exploring new dimensions when it comes to lifting and moving loads.

The pewag winner profilift range of lifting points stands out for its excellent compatibility with the pewag winner lifting chains that are used extensively on a global scale. pewag places great emphasis on the continuous improvement and innovation of its range of lifting points, focusing on the highest possible level of safety and user-friendliness. These two key elements have catapulted pewag to where it stands today, right at the top of its game.

pewag winner profilift lifting points comply with the Machine Directive 2006/42/EC and/or the Machine Safety Regulation 2010, EN 1677-1 as well as the technical specifications. Sophisticated design and individual serial numbers make this innovative range complete. The pewag winner profilift lifting points are produced in our ISO 9001 and 14001 certified plants and guarantee a 4- or 5-fold safety factor and a maximum dynamic load of min. 20,000 load cycles, tested at 1.5 times the load capacity.

Load capacities will vary according to the type of application, number of legs and angle of inclination and are listed in tables that form an integral part of the detailed user manual, corresponding to the Machine Safety Regulation 2010 and the Machine Directive. Each lifting point comes with its own manual.

The website www.pewag.com contains detailed information on load capacities, measures etc. as well as 3D models for designers, all ready for download.



Stamp with serial number



Testing in the pewag lab

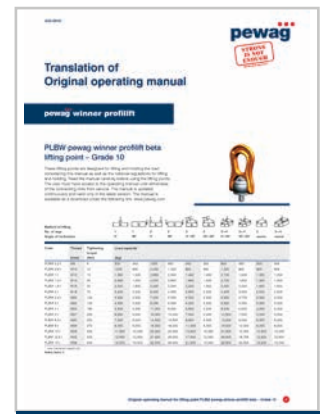

Operating manual

**pewag winner profilift –
Our products overcome
any challenge.**



pewag PLGW Eyebolt

pewag winner profilift gamma supreme eyebolt. Close to perfection.

A lifting point that was developed and manufactured according to the very latest standards also deserves a promising name: pewag winner profilift gamma supreme.

Simply tighten by hand, then align in the load direction – a system that is ideally suited for frequent assembly/disassembly. This patented system has proven itself from the beginning and promises unsurpassed ease-of-use.

The eyebolt is 360° rotatable, comes with an interchangeable special screw that is 100% crack-tested as well as chrome VI-free finish-protection against corrosion and is marked with the load capacity and the thread size. An integrated sleeve protects the surface of the load. The batch number displayed on all load-bearing parts such as the eye and screw as well as the serial number make identification, traceability and performance of mandatory, regular inspections simpler than ever.

PLGW supreme: tool-free assembly and disassembly

Latch in position 1: Latch is not in contact with the screw (fig. PLGW supreme rotatable)

- The latch is held in place with a patented spring
- The eyebolt is rotatable

Latch in position 2: Latch is in contact with the screw (fig. PLGW supreme disassembly)

- The latch is held in place with a patented spring
- The eyebolt is not rotatable, i.e. the fastening torque is transmitted to the screw and thus the eyebolt can be (re-)assembled

PLGW basic:

A simplified alternative is the pewag PLGW pewag winner profilift gamma basic. Offering the same benefits as the pewag PLGW supreme in terms of measurement, load capacity and application, the pewag PLGW basic differs solely when it comes to assembly: mounting and removing requires the use of a hexagon Allen wrench. A special Allen key for the sizes M8-M20 is available upon request. (fig. Special Allen key)

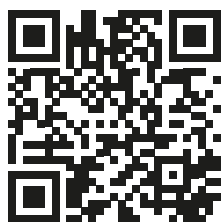

Assembly video PLGW



PLGW supreme – tool-free handling



PLGW supreme rotatable

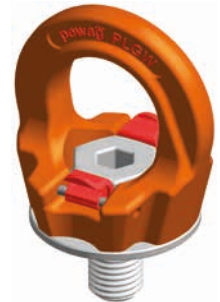

PLGW supreme disassembly



PLGW basic – assembly with tools

Permitted usage

For load capacities in the permitted directions of pull, please refer to the load capacity table. Adjust the lifting point in the permitted load direction before loading.

- Loadable with a 4-fold safety factor under break in all directions

Non-permitted usage

During assembly, ensure that improper loading cannot arise due to any of the following factors:

- Direction of pull is obstructed
- Direction of pull is not within the indicated area
- Loading ring rests against edges or loads
- Assembly with additional tools (e.g. extension) is not permitted

For additional details and information, please refer to the full operating manual.

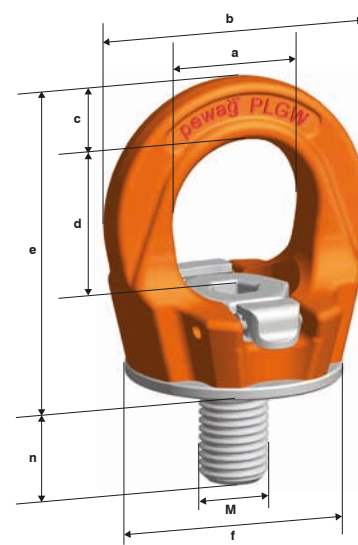

Please refer to the tables with technical data for all corresponding values

Calculating the required thread length (L):

$$L = H + S + K + X$$

H = Material height

S = Thickness of the washer

K = Height of the nut (depending on the thread size of the screw)

X = Excess length of the screw (twofold pitch of the screw)

L max. = n max.

In addition to the standard and maximum thread lengths, pewag also offers cut-to-length thread lengths.

Customised and maximum thread lengths are supplied with a washer and a crack-tested, corrosion-protected screw nut.

Each lifting point comes with an individual serial number.

Also available with peTAG upon request.

For detailed information such as method of lifting, number of legs, angle of inclination etc., please refer to the tables with the technical data.

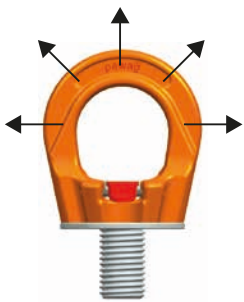

Permitted directions of pull

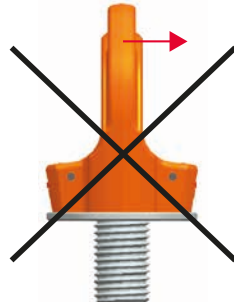

Non-permitted directions of pull

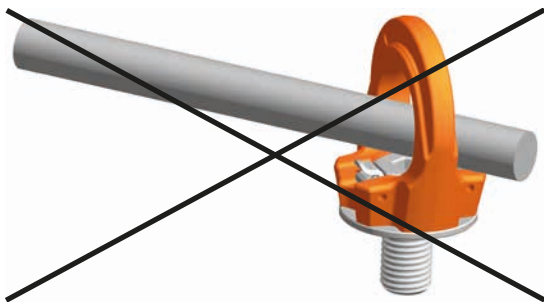

No additional tools permitted



Special Allen key

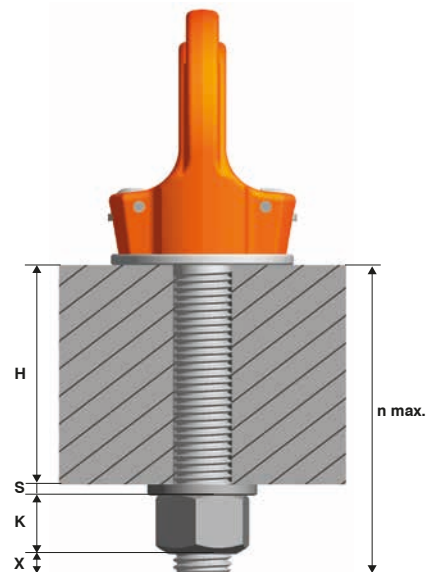

pewag PLGW Eyebolt

Method of lifting
Number of legs
Angle of inclination

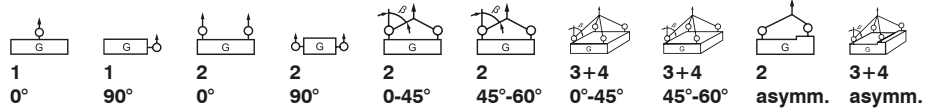

Code	Thread [mm]	Fastening torque [Nm]	Load capacity [kg]									
PLGW 0,3 t	M8	Simply tighten by hand	1,000	300	2,000	600	420	300	630	450	300	300
PLGW 0,5 t	M10		1,500	500	3,000	1,000	700	500	1,060	750	500	500
PLGW 0,7 t	M12		2,000	700	4,000	1,400	980	700	1,480	1,050	700	700
PLGW 1,5 t	M16		4,000	1,500	8,000	3,000	2,100	1,500	3,180	2,200	1,500	1,500
PLGW 2,3 t	M20		5,000	2,300	10,000	4,600	3,200	2,300	4,800	3,400	2,300	2,300
PLGW 3,2 t	M24		6,500	3,200	13,000	6,400	4,500	3,200	6,700	4,800	3,200	3,200
PLGW 4 t	M30		12,000	4,000	24,000	8,000	5,600	4,000	8,200	6,000	4,000	4,000
PLGW 4,9 t ¹⁾	M30		12,000	4,900	24,000	9,800	6,900	4,900	10,300	7,300	4,900	4,900
PLGW 7 t	M36		15,000	7,000	30,000	14,000	9,800	7,000	14,800	10,500	7,000	7,000
PLGW 9 t	M42		22,000	9,000	44,000	18,000	12,600	9,000	19,000	13,500	9,000	9,000
PLGW 12 t	M48		30,000	12,000	60,000	24,000	16,900	12,000	25,400	18,000	12,000	12,000

Code	Thread [inch]	Fastening torque [ft-lbs]	Load capacity [lbs]									
PLGW U 3/8	3/8"-16	Simply tighten by hand	2,400	1,100	4,800	2,200	1,500	1,100	2,200	1,500	1,100	1,100
PLGW U 1/2	1/2"-13		4,400	1,500	8,800	3,000	2,200	1,500	3,000	2,200	1,500	1,500
PLGW U 5/8	5/8"-11		8,800	3,300	17,600	6,600	4,600	3,300	6,600	4,800	3,300	3,300
PLGW U 3/4	3/4"-10		9,900	4,400	19,800	8,800	6,100	4,400	9,200	6,600	4,400	4,400
PLGW U 1	1"-8		11,000	6,600	22,000	13,200	9,200	6,600	13,600	9,900	6,600	6,600
PLGW U 1 1/4	1 1/4"-7		22,000	8,800	44,000	17,600	12,300	8,800	18,000	13,200	8,800	8,800
PLGW U 1 1/2	1 1/2"-6		33,000	15,400	66,000	30,800	21,500	15,400	32,300	23,100	15,400	15,400
PLGW U 1 3/4	1 3/4"-5		40,000	19,800	80,000	39,600	27,700	19,800	41,500	29,700	19,800	19,800

¹⁾ Higher load capacity soon available in this design

Safety factor 4

Important: Subject to technical changes!

Straight load direction 0°	Side load direction „allowed“ (ring aligned) 90°	Side load direction „not allowed“ (ring not aligned)
Higher load capacity in direction of screw axis (Column „0°“ in load table)	Nominal load capacity perpendicular to screw axis (Column „90°“ in load table)	Not allowed because of unstable condition. Ring could turn suddenly under load – high risk for load and/or people.

Code	Thread [mm]	Load capacity [kg]	a [mm]	b [mm]	c [mm]	d [mm]	e [mm]	f [mm]	n [mm]	n max [mm]	⊘ [mm]	Weight [kg/pc.]
PLGW 0,3 t	M8	300	25	45	10	27	53	35	15	90	6	0.20
PLGW 0,5 t	M10	500	25	45	10	27	53	35	15	160	6	0.21
PLGW 0,7 t	M12	700	30	55	12	32	63	43	20	160	8	0.32
PLGW 1,5 t	M16	1,500	35	64	14	36	70	50	25	160	10	0.48
PLGW 2,3 t	M20	2,300	40	73	16	41	81	54	30	160	12	0.58
PLGW 3,2 t	M24	3,200	50	86	18	50	93	69	35	-	14	1.10
PLGW 4 t	M30	4,000	60	110	25	60	114	90	45	-	17	2.20
PLGW 4,9 t ¹⁾	M30	4,900	60	110	25	60	114	90	45	-	17	2.20
PLGW 7 t	M36	7,000	70	132	31	70	136	108	55	-	19	3.80
PLGW 9 t	M42	9,000	80	152	36	72	153	126	65	-	22	5.70
PLGW 12 t	M48	12,000	95	179	42	88	179	148	75	-	24	8.90

Code	Thread [inch]	Load capacity [lbs]	a [inch]	b [inch]	c [inch]	d [inch]	e [inch]	f [inch]	n [inch]	n max [inch]	⊘ [inch]	Weight [lbs/pc.]
PLGW U 3/8	3/8"-16	1,100	0.98	1.77	0.39	1.06	2.09	1.38	0.59	-	1/4"	0.44
PLGW U 1/2	1/2"-13	1,500	1.18	2.17	0.47	1.26	2.48	1.69	0.79	-	5/16"	0.71
PLGW U 5/8	5/8"-11	3,300	1.38	2.52	0.55	1.42	2.76	1.97	0.98	-	3/8"	0.99
PLGW U 3/4	3/4"-10	4,400	1.57	2.87	0.63	1.61	3.19	2.13	1.18	-	1/2"	1.28
PLGW U 1	1"-8	6,600	1.97	3.39	0.71	1.97	3.66	2.72	1.38	-	9/16"	2.43
PLGW U 1 1/4	1 1/4"-7	8,800	2.36	4.33	0.98	2.36	4.49	3.54	1.77	-	5/8"	4.63
PLGW U 1 1/2	1 1/2"-6	15,400	2.76	5.20	1.22	2.76	5.35	4.25	2.17	-	7/8"	8.38
PLGW U 1 3/4	1 3/4"-5	19,800	3.15	5.98	1.42	2.83	6.02	4.96	2.56	-	1"	12.57

¹⁾ Higher load capacity soon available in this design

Safety factor 4

Important: Subject to technical changes!

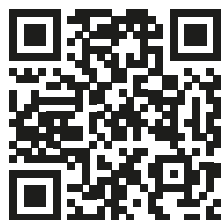

For 3D data on the lifting points, visit www.pewag.com

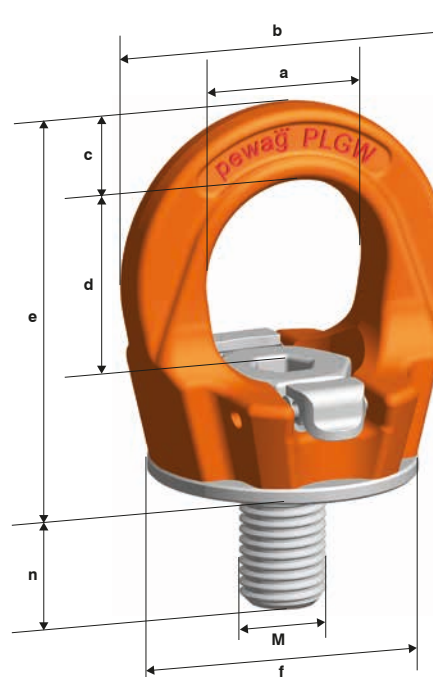

pewag PLGW-SN Supreme screw nut

Globally unique.

This screw nut works on the principle of tool-free assembly, which makes it unique worldwide. It takes the successful pewag PLGW supreme eyebolt one step further and is used on loads that come with a threaded bolt instead of a thread.

Alternatively, the PLGW-SN supreme lifting point may be attached in a through-hole using a standard screw, which has the additional advantage of being able to use the same lifting point with different material thicknesses. This method requires just crack-tested screws (strength category 10.9) of different lengths.

For additional details and information, please refer to the full operating manual.

Further benefits of the PLGW-SN pewag winner profilift gamma supreme:

- No tools are required for assembly or disassembly
- Saves time, especially if frequent assembly/disassembly takes place
- The lifting point is rotatable (may be set in the load direction) and loadable in all directions

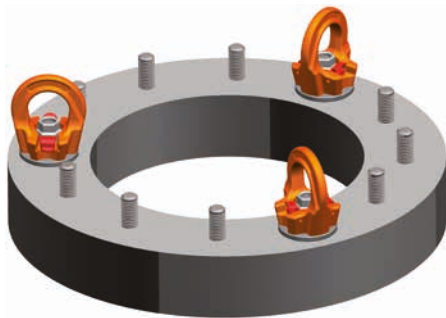

Existing threaded bolts

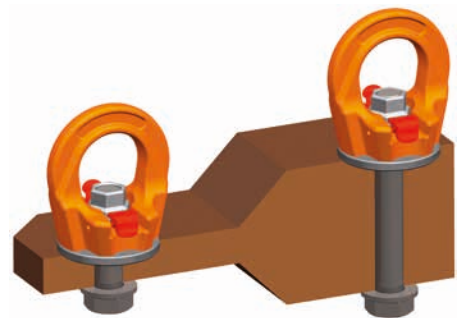

Different material thicknesses



Assembly video PLGW-SN

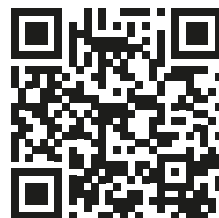

For 3D data on the lifting points, visit www.pewag.com

Permitted usage

For load capacities in the permitted directions of pull, please refer to the load capacity table. Adjust the lifting point in the permitted load direction before loading.

- Loadable with a 4-fold safety factor under break in all directions

Non-permitted usage

During assembly, ensure that improper loading cannot arise due to any of the following factors:

- Direction of pull is obstructed
- Direction of pull is not within the indicated area
- Loading ring rests against edges or loads

Each lifting point comes with an individual serial number. Also available with peTAG upon request.

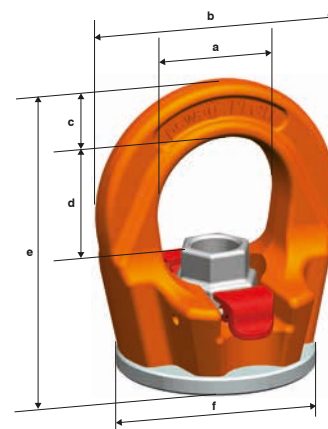

Please refer to the tables with technical data for all corresponding values

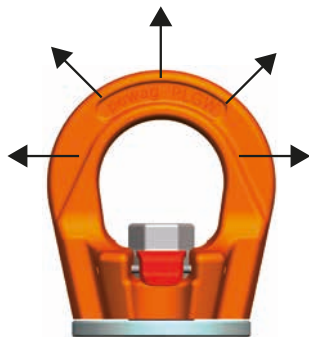

Permitted directions of pull



Use of PLGW or PLGW-SN

Method of lifting

Number of legs

Angle of inclination

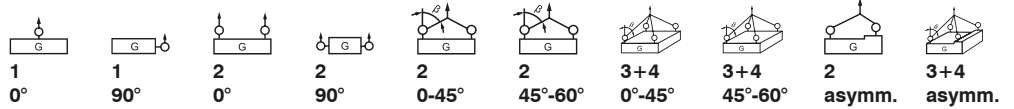

Code	Thread [mm]	Load capacity [kg]									
PLGW-SN 0.3 t	M8	1,000	300	2,000	600	400	300	600	400	300	300
PLGW-SN 0.5 t	M10	1,500	500	3,000	1,000	700	500	1,000	700	500	500
PLGW-SN 0.7 t	M12	2,000	700	4,000	1,400	1,000	700	1,400	1,000	700	700
PLGW-SN 1.5 t	M16	4,000	1,500	8,000	3,000	2,100	1,500	3,000	2,200	1,500	1,500
PLGW-SN 2.3 t	M20	5,000	2,300	10,000	4,600	3,200	2,300	4,800	3,400	2,300	2,300
PLGW-SN 3.5 t	M24	6,500	3,500	13,000	7,000	4,900	3,500	7,400	5,200	3,500	3,500
PLGW-SN 4.9 t	M30	12,000	4,900	24,000	9,000	6,900	4,900	10,300	7,300	4,900	4,900

Code	Thread [mm]	Load capacity [kg]	a [mm]	b [mm]	c [mm]	d [mm]	e [mm]	f [mm]	⊘ [mm]	Weight [kg/pc.]
PLGW-SN 0,3 t	M8	300	25	45	10	21	55	35	12	0.17
PLGW-SN 0,5 t	M10	500	25	45	10	21	55	35	12	0.17
PLGW-SN 0,7 t	M12	700	30	55	12	25	65	43	14	0.28
PLGW-SN 1,5 t	M16	1,500	35	64	14	29	72	50	19	0.42
PLGW-SN 2,3 t	M20	2,300	40	73	16	34	82	54	22	0.50
PLGW-SN 3,5 t	M24	3,500	50	86	18	40	95	69	27	1.00
PLGW-SN 4,9 t	M30	4,900	60	110	25	47	115	90	36	1.90

Load capacity applies to crack-tested screws in strength category 10.9

pewag PLGWI Eyebolt

PLGWI pewag winner profilift gamma inox – patented, rust-resistant comfort.

Naturally, the PLGW lifting point is also available in a corrosion-resistant version – as the PLGWI eyebolt, offering all the tried-and-tested pewag advantages: versatility when it comes to areas of application, accurately fitted measurements, optimised load capacities and unsurpassed ease-of-use. But the PLGWI offers even more than that:

The eyebolt is 360° rotatable, comes with an interchangeable special screw that is 100% crack-tested and marked with the load capacity and the thread size! An integrated sleeve protects the surface of the load. The batch number displayed on all load-bearing parts such as the eye and screws as well as the serial number make identification, traceability and performance of mandatory, regular inspections simpler than ever.

Additional benefits of the PLGW inox lifting point:

- Extendable areas of application thanks to Duplex steel with heightened corrosion-resistance
- With the “Basic” version, the PRE/N value that determines the alloy composition and thus also the level of corrosion-resistance lies at approx. 34

PLGWI supreme: tool-free assembly and disassembly

Latch in position 1: Latch is not in contact with the screw.

(fig. PLGWI supreme rotatable)

- The latch is held in place with a patented spring
- The eyebolt is rotatable

Latch in position 2: Latch is in contact with the screw.

(fig. PLGWI supreme disassembly)

- The latch is held in place with a patented spring
- The eyebolt is not rotatable, i.e. the fastening torque is transmitted to the screw and thus the eyebolt can be (re-)assembled

PLGWI basic:

A simplified alternative is the pewag PLGWI pewag winner profilift gamma inox basic. Offering the same benefits as the pewag PLGW in terms of measurement, load capacity and application, the pewag PLGW basic differs solely when it comes to assembly, as mounting and removing requires the use of a hexagon Allen wrench.

For the “Supreme” version of the PLGWI lifting point, the name really says it all: Its tool-free assembly is patented and unique. The “Basic” version requires a hexagon Allen wrench for mounting and removal. The basic version is made exclusively from Duplex, with ring, screw and sleeve manufactured from 1.4462. In the “Supreme” version, the elements of the latching system are made from corrosion-resistant material. Each eyebolt comes with an operating manual that contains detailed information on usage as well as a load capacity table categorised by lifting method, number of legs and angle of inclination, for easy reference whenever you need it.



PLGWI supreme – tool-free handling



PLGWI supreme rotatable



PLGWI supreme disassembly



PLGWI basic – assembly with tools

Permitted usage

For load capacities in the permitted directions of pull, please refer to the load capacity table.

- Adjust the lifting point in the permitted load direction before loading
- Loadable with a 4-fold safety factor under break in all directions

Non-permitted usage

During assembly, ensure that improper loading cannot arise due to any of the following factors

- Direction of pull is obstructed
- Direction of pull is not within the indicated area
- Loading ring rests against edges or loads

For additional details and information, please refer to the full operating manual.

Each lifting point comes with an individual serial number.

For detailed information such as method of lifting, number of legs, angle of inclination etc., please refer to the tables with the technical data.



Please refer to the tables with technical data for all corresponding values

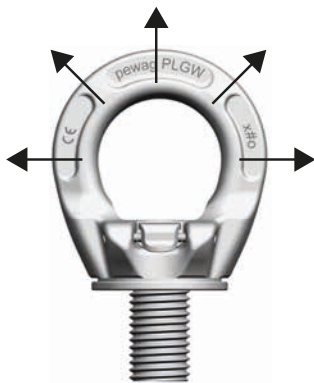

Permitted directions of pull

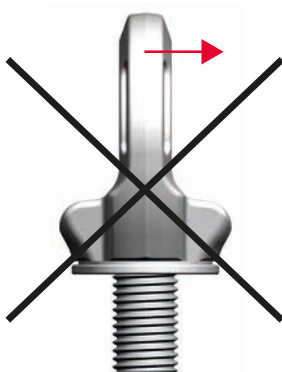

Non-permitted directions of pull



Assembly video PLGW

pewag PLGWI Eyebolt

Method of lifting
Number of legs
Angle of inclination

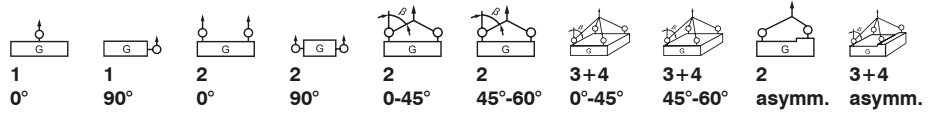

Code	Thread [mm]	Fastening torque [Nm]	Load capacity [kg]									
PLGWI 2 t	M20	Simply tighten by hand	3,800	2,000	7,600	4,000	2,800	2,000	4,200	3,000	2,000	2,000

Code	Thread [mm]	Load capacity [kg]	a [mm]	b [mm]	c [mm]	d [mm]	e [mm]	f [mm]	n [mm]	n max [mm]	⊘ [mm]	Weight [kg/pc.]
PLGWI 2 t	M20	2,000	40	72	17	40	80	45	30	160	12	0.60

Straight load direction 0°	Side load direction „allowed“ (ring aligned) 90°	Side load direction „not allowed“ (ring not aligned)
Higher load capacity in direction of screw axis (Column „0°“ in load table)	Nominal load capacity perpendicular to screw axis (Column „90°“ in load table)	Not allowed because of unstable condition. Ring could turn suddenly under load – high risk for load and/or people.

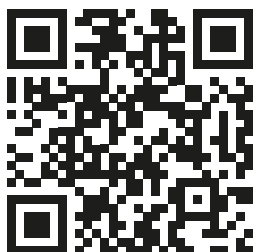

For 3D data on the lifting points, visit www.pewag.com



PLGW in comparison: game, set and match

- Significantly higher load capacity with the same thread size
- Rotatable by 360°, thus adjustable in the load direction
- Four-fold safety factor under break in all directions
- 100% crack-tested screw

PLGW Eyebolts and/or PLGW-SN Ring nut			DIN 580 Eyebolt and/or DIN 582 Ring nut				
	Product	PLGW (SN)	DIN 580 / DIN 582		PLGW (SN)	DIN 580 / DIN 582	
	Thread size	M12	M12	1*) 2*)	M36	M36	1*) 2*)
	Nominal load capacity	0.7 t	0.34 t		7 t	4.6 t	
	WLL	2 t	0.34 t	M30	15 t	4.6 t	M64
	Breaking load limit	8 t	2.04 t		60 t	27.6 t	
	WLL (<math>< 45^\circ</math>)	0.7 t	0.24 t	M20	7 t	3.3 t	M56
	Breaking load limit (<math>< 45^\circ</math>)	2.8 t	1.44 t		28 t	19.8 t	
	WLL (<math>< 45^\circ</math> lateral)	0.7 t	0.17 t	M24	7 t	2.3 t	M64
	Breaking load limit (<math>< 45^\circ</math> lateral)	2.8 t	1.02 t		28 t	13.8 t	

1*) Refers to the size DIN 580 required to carry the same load as the pewag profillift gamma (in the appropriate direction of loading).

Mode of application: Single-leg, straight pull, load = 2 t, required thread size pewag PLGW: M12, required thread size eyebolt DIN 580: M30

Mode of application: Multi-leg sling

2*) The carrying capacity of DIN 580 applies only if the screws are screwed in completely and rest on the load with the entire contact surface. Since it is highly likely that at least one screw is loaded in the wrong direction, pewag recommends the adjustable eyebolts PLGW, which may always be aligned with the direction of pull.



Size comparison PLGW M12 – DIN 580-M30

pewag[®] PLAW Alpha

pewag winner profilift alpha. Simply the best!

This lifting point is 360° rotatable. The load ring is loadable in a wide range and can be positioned at any required angle due to its replaceable and patented spring. The hexagonal special screw is also replaceable and secured against loss.

The PLAW pewag winner profilift alpha screw is made from 10.9 grade material, 100% crack-tested, covered with a chromate VI-free protection agent against corrosion and marked with the load capacity and thread size.

pewag winner profilift alpha is able to withstand a 4-fold safety factor against break in all directions and every single lifting point is marked with an individual serial number. pewag winner profilift alpha is available with metric or UNC-thread.

The versions with metric thread are also available with customised thread lengths. All load capacities, categorised by type of application, the number of legs and angle of inclination, are contained in a table that forms an integral part of the operating manual included with each lifting point.

Also available with peTAG upon request.



PLAW 0.3 t - 1.5 t and PLAW 4 t / 13



PLAW 2.5 t - 20 t



Permitted usage

For load capacities in the permitted directions of pull, please refer to the load capacity table.

Non-permitted usage

During assembly, ensure that improper loading cannot arise due to any of the following factors:

- Direction of pull is obstructed
- Direction of pull is not within the indicated area
- Loading ring rests against edges or loads

The load ring must be placed in the direction of pull before loading – do not turn under load! For additional details and information, please refer to the full operating manual.

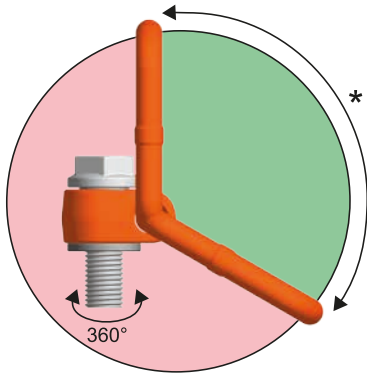

Permissible range of application (ring)

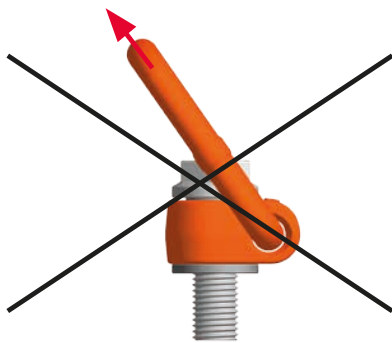

Non-permitted direction of pull

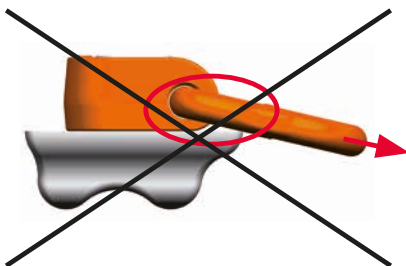

Non-permitted usage because of resting against edges or loads

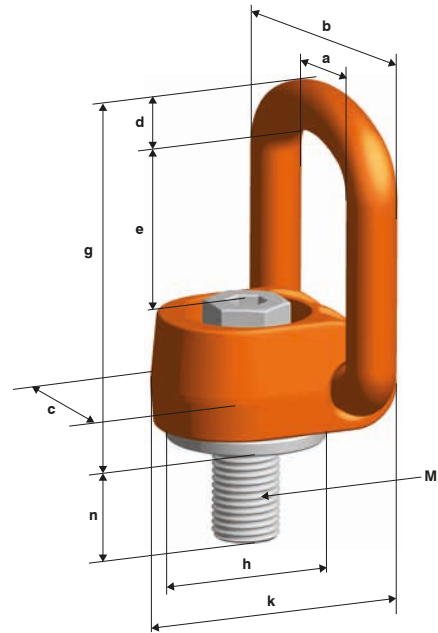

Please refer to the tables with technical data for all corresponding values

Calculating the required thread length (L):

$$L = H + S + K + X$$

H = Material height

S = Thickness of the washer

K = Height of the nut (depending on the thread size of the screw)

X = Excess length of the screw (twofold pitch of the screw)

L max. = n max.

In addition to the standard and maximum thread lengths, pewag also offers cut-to-length thread lengths. Customised and maximum thread lengths are supplied with a washer and a crack-tested, corrosion-protected screw nut.

For detailed information such as method of lifting, number of legs, angle of inclination etc., please refer to the tables with technical data.

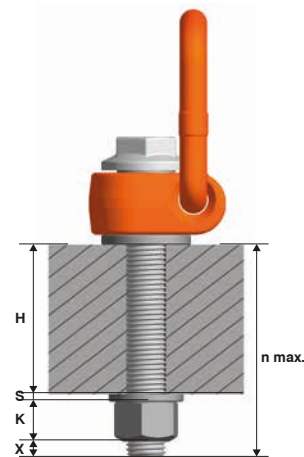

pewag PLAW Alpha

Method of lifting
Number of legs
Angle of inclination

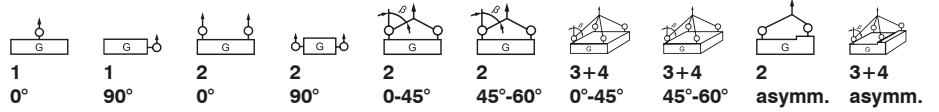

Code	Thread [mm]	Fastening torque [Nm]	Load capacity [kg]									
PLAW 0,3 t	M8	35	300	300	600	600	400	300	600	400	300	300
PLAW 0,63 t	M10	70	630	630	1,260	1,260	850	630	1,300	900	630	630
PLAW 1 t	M12	120	1,000	1,000	2,000	2,000	1,400	1,000	2,100	1,500	1,000	1,000
PLAW 1,5 t	M16	150	1,500	1,500	3,000	3,000	2,100	1,500	3,100	2,200	1,500	1,500
PLAW 2,5 t	M20	170	2,500	2,500	5,000	5,000	3,500	2,500	5,300	3,700	2,500	2,500
PLAW 4 t (/13)	M24	400	4,000	4,000	8,000	8,000	5,600	4,000	8,400	6,000	4,000	4,000
PLAW 6 t	M30	500	6,000	6,000	12,000	12,000	8,500	6,000	12,700	9,000	6,000	6,000
PLAW 7 t ¹⁾	M36	700	7,000	7,000	14,000	14,000	9,800	7,000	14,800	10,500	7,000	7,000
PLAW 8 t	M36	800	8,000	8,000	16,000	16,000	11,300	8,000	16,900	12,000	8,000	8,000
PLAW 10 t	M42	1,500	10,000	10,000	20,000	20,000	14,000	10,000	21,000	15,000	10,000	10,000
PLAW 15 t	M42	1,500	15,000	15,000	30,000	30,000	21,000	15,000	31,500	22,500	15,000	15,000
PLAW 20 t	M48	2,000	20,000	20,000	40,000	40,000	28,000	20,000	42,000	30,000	20,000	20,000

Code	Thread [inch]	Fastening torque [ft-lbs]	Load capacity [lbs]									
PLAW U3/8	3/8"-16	52	1,400	1,400	2,800	2,800	1,980	1,400	2,970	2,100	1,400	1,400
PLAW U1/2	1/2"-13	89	2,200	2,200	4,400	4,400	3,000	2,200	4,600	3,300	2,200	2,200
PLAW U5/8	5/8"-11	110	3,300	3,300	6,600	6,600	4,600	3,300	6,800	4,800	3,300	3,300
PLAW U3/4	3/4"-10	125	4,400	4,400	8,800	8,800	6,000	4,400	9,200	6,500	4,400	4,400
PLAW U1	1"-8	295	8,800	8,800	17,600	17,600	12,300	8,800	18,400	13,200	8,800	8,800
PLAW U1 1/4	1 1/4"-7	369	13,200	13,200	26,400	26,400	18,700	13,200	27,800	19,800	13,200	13,200
PLAW U1 1/2	1 1/2"-6	590	17,600	17,600	35,200	35,200	24,800	17,600	37,300	26,400	17,600	17,600
PLAW U1 3/4	1 3/4"-5	740	22,000	22,000	44,000	44,000	30,000	22,000	45,000	33,000	22,000	22,000

¹⁾ Available upon request only!

Safety factor 4

Important: Subject to technical changes!

<p>Straight load direction 0°</p>	<p>Side load direction „allowed“ (ring aligned) 90°</p>
Nominal load capacity in direction of screw axis (column „0°“ in load table)	Nominal load capacity perpendicular to screw axis (Column „90°“ in load table)

Code	Thread [mm]	Load capacity [kg]	a [mm]	b [mm]	c [mm]	d [mm]	e [mm]	g [mm]	h [mm]	k [mm]	n [mm]	n max [mm]	⌀ [mm]	⊥ [mm]	Weight [kg/pc.]
PLAW 0,3 t	M8	300	45	67	40	11	41	95	36	55	20	150	10	24	0.57
PLAW 0,63 t	M10	630	45	67	40	11	41	95	36	55	20	150	10	24	0.58
PLAW 1 t	M12	1,000	45	67	40	11	41	95	36	55	33	170	10	24	0.60
PLAW 1,5 t	M16	1,500	45	67	40	11	41	95	36	55	33	260	10	24	0.62
PLAW 2,5 t	M20	2,500	54	81	50	13	55	112	50	67	33	335	8	24	1.10
PLAW 4 t (/13)	M24	4,000	54	87	50	17	67	142	45	70	36	361	14	36	1.60
PLAW 6 t	M30	6,000	75	115	67	20	68	143	67	100	49	364	14	36	3.10
PLAW 7 t ¹⁾	M36	7,000	75	115	67	20	65	143	60	100	55	374	27	-	3.30
PLAW 8 t	M36	8,000	93	147	85	27	87	188	85	120	55	365	19	41	6.10
PLAW 10 t	M42	10,000	93	147	85	27	87	188	85	120	65	365	19	41	6.40
PLAW 15 t	M42	15,000	115	181	105	33	108	246	106	150	63	340	19	55	12.00
PLAW 20 t	M48	20,000	115	181	105	33	108	246	106	150	73	340	19	55	12.30

Code	Thread [inch]	Load capacity [lbs]	a [inch]	b [inch]	c [inch]	d [inch]	e [inch]	g [inch]	h [inch]	k [inch]	n [inch]	n max [inch]	⌀ [inch]	⊥ [inch]	Weight [lbs/pcs.]
PLAW U3/8	3/8"-16	1,400	1.77	2.64	1.57	0.43	1.71	3.56	1.42	2.17	1.30	-	5/16"	-	1.28
PLAW U1/2	1/2"-13	2,200	1.77	2.64	1.57	0.43	1.61	3.72	1.42	2.17	1.30	-	3/8"	15/16"	1.32
PLAW U5/8	5/8"-11	3,300	1.77	2.64	1.57	0.43	1.71	3.56	1.42	2.17	1.30	-	1/2"	-	1.41
PLAW U3/4	3/4"-10	4,400	2.13	3.19	1.97	0.51	2.24	4.21	1.97	2.64	1.30	-	9/16"	-	2.40
PLAW U1	1"-8	8,800	2.95	4.53	2.64	0.79	2.68	5.63	2.64	3.94	1.42	-	3/4"	-	6.60
PLAW U1 1/4	1 1/4"-7	13,200	2.95	4.53	2.64	0.79	2.68	5.63	2.64	3.94	1.93	-	7/8"	-	6.80
PLAW U1 1/2	1 1/2"-6	17,600	3.66	5.79	3.35	1.06	3.43	7.40	3.35	4.72	2.09	-	1"	-	13.40
PLAW U1 3/4	1 3/4"-5	22,000	3.66	5.79	3.35	1.06	3.43	7.40	3.35	4.72	2.44	-	1 1/4"	-	14.10

¹⁾ Available upon request only!

Safety factor 4

Important: Subject to technical changes!

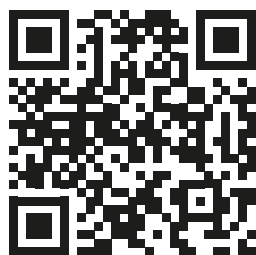

For 3D data on the lifting points, visit www.pewag.com

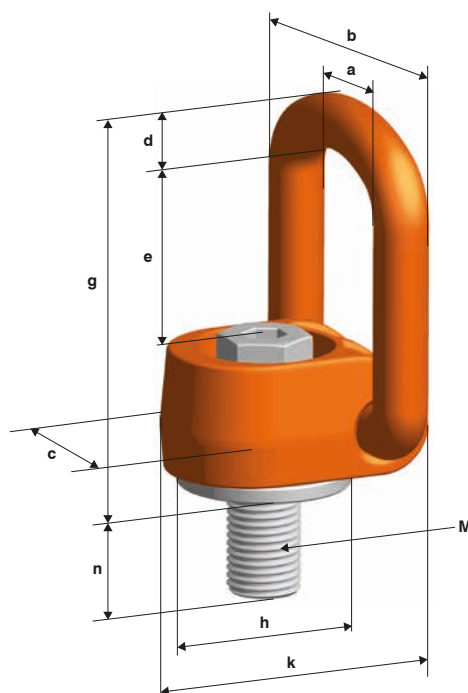

pewag[®] PLBW Beta

pewag winner profilift beta. Five-fold safety.

This is another lifting point that is 360° rotatable. The load ring is movable to an angle of 180° and can be positioned at any required angle due to its replaceable and patented spring. In the permitted applications, this lifting point offers five-fold safety.

Due to the pewag quality standard, each lifting point comes with an individual serial number. The lifting points are marked with the admissible load capacity for the most unfavourable application mode, allowing for an increased load capacity in case of vertical loads.

The hexagonal special screw made from grade 10.9 material is also interchangeable and secured against loss. The screw is 100% crack-tested as well as covered with a chromate VI-free protection against corrosion and marked with the load capacity and thread size. It can be tightened with a hexagon wrench or spanner wrench.

pewag winner profilift beta is available with metric or UNC-thread. The versions with metric thread are also available with customised thread lengths.

All load capacities, categorised by method of lifting, number of legs and angle of inclination are contained in a table that forms an integral part of the operating manual included with each lifting point.

Also available with peTAG upon request.

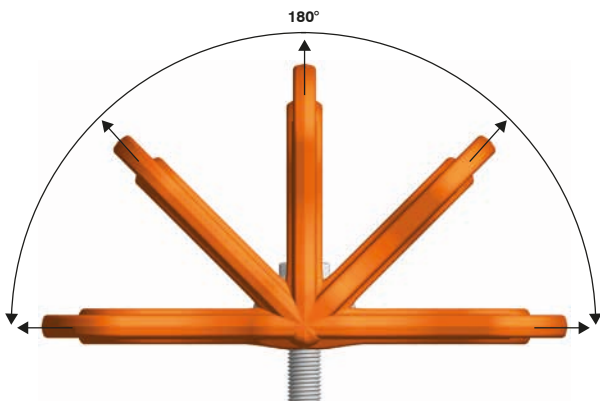

Permitted directions of pull



Permitted directions of pull

Permitted usage

For load capacities in the permitted directions of pull please refer to the load capacity table.

Non-permitted usage

During assembly, ensure that improper loading cannot arise due to any of the following factors:

- Direction of pull is obstructed
- Direction of pull is not within the indicated area
- Loading ring rests against edges or loads

The loading ring must be placed in the direction of pull before loading – do not turn under load! For additional details and information, please refer to the full operating manual.

Calculating the required thread length (L):

$$L = H + S + K + X$$

H = Material height

S = Thickness of the washer

K = Height of the nut (depending on the thread size of the screw)

X = Excess length of the screw (twofold pitch of the screw)

L max. = n max.

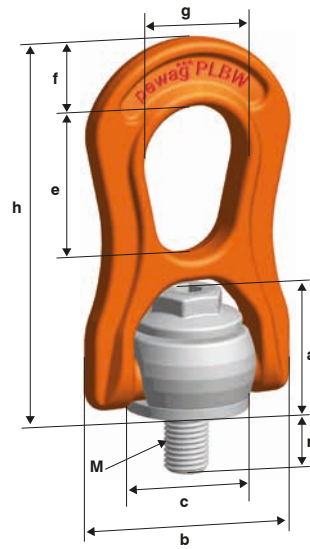

Please refer to the tables with technical data for all corresponding values

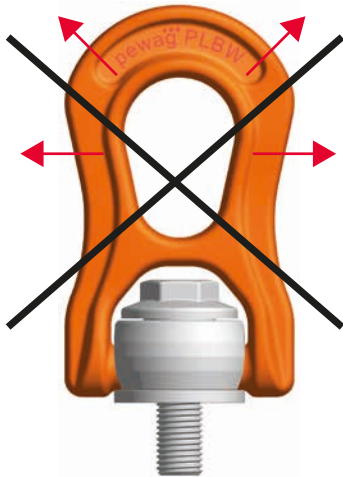

Non-permitted directions of pull

In addition to the standard and maximum thread lengths, pewag also offers cut-to-length thread lengths. Customised and maximum thread lengths are supplied with a washer and a crack-tested, corrosion-protected screw nut.

For detailed information such as method of lifting, number of legs, angle of inclination etc., please refer to the tables with technical data.

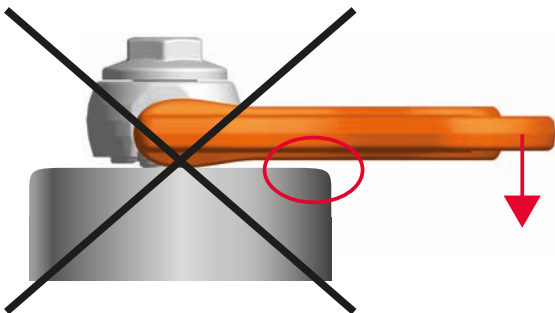

Non-permitted usage because of resting against edges or loads

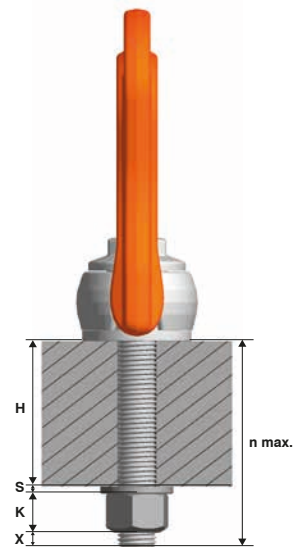

pewag PLBW Beta

Method of lifting
Number of legs
Angle of inclination

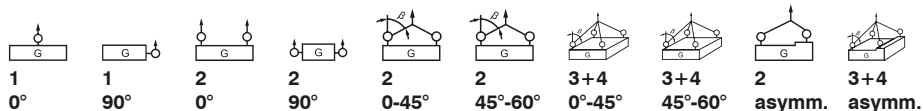

Code	Thread [mm]	Fastening torque [Nm]	Load capacity [kg]									
PLBW 0,3 t	M8	6	500	300	1,000	600	400	300	600	450	300	300
PLBW 0,6 t	M10	10	1,000	600	2,000	1,200	800	600	1,300	900	600	600
PLBW 1 t	M12	15	1,300	1,000	2,600	2,000	1,400	1,000	2,100	1,500	1,000	1,000
PLBW 1,3 t	M14	30	2,000	1,300	4,000	2,600	1,800	1,300	2,700	1,900	1,300	1,300
PLBW 1,6 t	M16	50	2,500	1,600	5,000	3,200	2,200	1,600	3,400	2,400	1,600	1,600
PLBW 2 t	M18	70	3,000	2,000	6,000	4,000	2,800	2,000	4,200	3,000	2,000	2,000
PLBW 2,5 t	M20	100	3,500	2,500	7,000	5,000	3,500	2,500	5,300	3,700	2,500	2,500
PLBW 3 t	M22	120	4,500	3,000	9,000	6,000	4,200	3,000	6,300	4,500	3,000	3,000
PLBW 4 t	M24	160	5,500	4,000	11,000	8,000	5,600	4,000	8,400	6,000	4,000	4,000
PLBW 5 t	M27	200	6,500	5,000	13,000	10,000	7,000	5,000	10,500	7,500	5,000	5,000
PLBW 6,3 t	M30	250	7,000	6,300	14,000	12,600	8,800	6,300	13,200	9,400	6,300	6,300
PLBW 8 t	M33	270	9,000	8,000	18,000	16,000	11,000	8,000	16,500	12,000	8,000	8,000
PLBW 10 t	M36	320	11,000	10,000	22,000	20,000	14,000	10,000	21,000	15,000	10,000	10,000
PLBW 12,5 t	M42	400	13,500	12,500	27,000	25,000	17,500	12,500	26,300	18,700	12,500	12,500
PLBW 15 t	M48	600	16,000	15,000	32,000	30,000	21,000	15,000	32,000	22,500	15,000	15,000

Code	Thread [inch]	Fastening torque [ft-lbs]	Load capacity [lbs]									
PLBW U5/16	5/16"-18	4.50	1,100	660	2,200	1,320	900	660	1,400	900	660	660
PLBW U 3/8	3/8"-16	7.50	2,200	1,300	4,400	2,600	1,800	1,300	2,700	1,900	1,300	1,300
PLBW U 1/2	1/2"-13	11	2,800	2,200	5,600	4,400	3,000	2,200	4,600	3,300	2,200	2,200
PLBW U 7/16	7/16"-14	11	2,800	2,200	5,600	4,400	3,000	2,200	4,600	3,300	2,200	2,200
PLBW U 9/16	9/16"-12	22	4,400	3,000	8,800	6,000	4,200	3,000	6,300	4,500	3,000	3,000
PLBW U 5/8	5/8"-11	37	5,500	3,500	11,000	7,000	4,900	3,500	7,300	5,200	3,500	3,500
PLBW U 3/4	3/4"-10	74	6,600	5,500	13,200	11,000	7,700	5,500	11,500	8,200	5,500	5,500
PLBW U 7/8	7/8"-9	118	12,000	8,800	24,000	17,600	12,300	8,800	18,500	13,200	8,800	8,800
PLBW U1	1"-8	148	13,000	11,000	26,000	22,000	15,400	11,000	23,000	16,500	11,000	11,000
PLBW U1 1/8	1 1/8"-7	185	14,300	13,500	28,600	27,000	18,900	13,500	28,300	20,200	13,500	13,500
PLBW U1 1/4	1 1/4"-7	200	19,800	17,500	39,600	35,000	24,500	17,500	36,700	26,200	17,500	17,500
PLBW U1 3/8	1 3/8"-6	236	24,000	22,000	48,000	44,000	30,800	22,000	46,200	33,000	22,000	22,000
PLBW U1 1/2	1 1/2"-6	295	25,000	24,000	50,000	48,000	33,600	24,000	50,400	36,000	24,000	24,000

Straight load direction 0°	Side load direction „allowed“ (ring aligned) 90°	Side load direction „not allowed“ (ring not aligned)
Higher load capacity in direction of screw axis (Column „0°“ in load table)	Nominal load capacity perpendicular to screw axis (Column „90°“ in load table)	Not allowed because of unstable condition. Ring could turn suddenly under load – high risk for load and/or people.

Code	Thread [mm]	Load capacity [kg]	a [mm]	b [mm]	c [mm]	e [mm]	f [mm]	g [mm]	h [mm]	n [mm]	n max [mm]	⌀ [mm]	⊥ [mm]	Weight [kg/pc.]
PLBW 0,3 t	M8	300	29	56	30	38	18	27	94	13	80	8	15	0.31
PLBW 0,6 t	M10	600	29	56	30	38	18	27	94	15	100	8	15	0.35
PLBW 1 t	M12	1,000	29	56	30	38	18	27	94	17	180	8	15	0.37
PLBW 1,3 t	M14	1,300	43	79	45	55	25	38	138	22	220	10	24	1.03
PLBW 1,6 t	M16	1,600	43	79	45	55	25	38	138	24	260	10	24	1.04
PLBW 2 t	M18	2,000	43	79	45	55	25	38	138	27	295	10	24	1.07
PLBW 2,5 t	M20	2,500	43	79	45	55	25	38	138	30	335	10	24	1.08
PLBW 3 t	M22	3,000	64	118	68	85	38	58	209	33	355	14	36	3.50
PLBW 4 t	M24	4,000	64	118	68	85	38	58	209	36	355	14	36	3.60
PLBW 5 t	M27	5,000	64	118	68	85	38	58	209	40	355	14	36	3.60
PLBW 6,3 t	M30	6,300	64	118	68	85	38	58	209	45	355	14	36	3.70
PLBW 8 t	M33	8,000	106	188	108	132	60	91	331	54	328	19	55	14.30
PLBW 10 t	M36	10,000	106	188	108	132	60	91	331	59	328	19	55	14.40
PLBW 12,5 t	M42	12,500	106	188	108	132	60	91	331	69	328	19	55	14.70
PLBW 15 t	M48	15,000	106	188	108	132	60	91	331	74	328	19	55	15.00

Code	Thread [inch]	Load capacity [lbs]	a [inch]	b [inch]	c [inch]	e [inch]	f [inch]	g [inch]	h [inch]	n [inch]	n max [inch]	⌀ [inch]	⊥ [inch]	Weight [lbs/pcs.]
PLBW U5/16	5/16"-18	660	1.14	2.20	1.18	1.50	0.71	1.06	3.70	0.51	-	5/16"	5/8"	0.71
PLBW U 3/8	3/8"-16	1,300	1.14	2.20	1.18	1.50	0.71	1.06	3.70	0.59	-	5/16"	5/8"	0.73
PLBW U 1/2	1/2"-13	2,200	1.14	2.20	1.18	1.50	0.71	1.06	3.70	0.67	-	5/16"	5/8"	0.77
PLBW U 7/16	7/16"-14	2,200	1.14	2.20	1.18	1.50	0.71	1.06	3.70	0.67	-	5/16"	5/8"	0.75
PLBW U 9/16	9/16"-12	3,000	1.69	3.11	1.77	2.17	0.98	1.50	5.43	0.87	-	5/16"	1"	2.27
PLBW U 5/8	5/8"-11	3,500	1.69	3.11	1.77	2.17	0.98	1.50	5.43	0.94	-	5/16"	1"	2.29
PLBW U 3/4	3/4"-10	5,500	1.69	3.11	1.77	2.17	0.98	1.50	5.43	1.18	-	5/16"	1"	2.38
PLBW U 7/8	7/8"-9	8,800	2.52	4.65	2.68	3.35	1.50	2.28	8.23	1.42	-	9/16"	1 3/8"	7.78
PLBW U1	1"-8	11,000	2.52	4.65	2.68	3.35	1.50	2.28	8.23	1.57	-	9/16"	1 3/8"	7.89
PLBW U1 1/8	1 1/8"-7	13,500	2.52	4.65	2.68	3.35	1.50	2.28	8.23	1.77	-	9/16"	1 3/8"	8.07
PLBW U1 1/4	1 1/4"-7	17,500	4.17	7.40	4.25	5.20	2.36	3.58	13.03	2.13	-	3/4"	2 3/16"	32.00
PLBW U1 3/8	1 3/8"-6	22,000	4.17	7.40	4.25	5.20	2.36	3.58	13.03	2.32	-	3/4"	2 3/16"	32.20
PLBW U1 1/2	1 1/2"-6	24,000	4.17	7.40	4.25	5.20	2.36	3.58	13.03	2.72	-	3/4"	2 3/16"	32.80

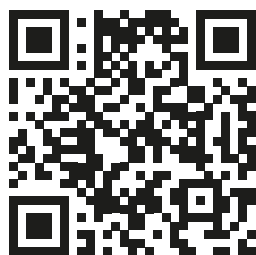

For 3D data on the lifting points, visit www.pewag.com

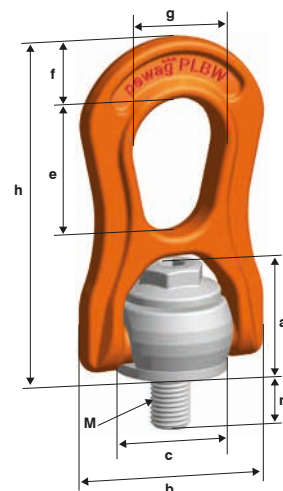

pewag[®] PLDW Delta

pewag winner profilift delta. Rotatable even under load.

This lifting point comes with a ball bearing and is rotatable by 360° even under load. The high-strength lifting eye is movable by 180°. The special screw is 100% crack-tested, protected against corrosion and marked with the load capacity and thread size. In addition, each lifting point is marked with its own individual serial number. The high-strength lifting eye comes with a ring and is wide enough to accommodate even larger hooks.

All load capacities, categorised by method of lifting, number of legs and angle of inclination are contained in a table that forms an integral part of the operating manual included with each lifting point. The pewag winner profilift delta lifting points are marked with the admissible load capacity for the most unfavourable application mode, allowing for an increased load capacity in case of vertical loads and four-fold safety against break in all directions.

Also available with peTAG upon request.

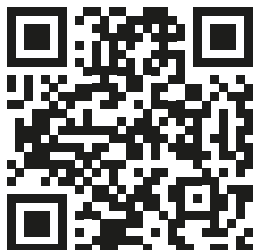

For 3D data on the lifting points,
visit www.pewag.com



Permitted usage

For load capacities in the permitted directions of pull, please refer to the load capacity table.

Non-permitted usage

During assembly, ensure that improper loading cannot arise due to any of the following factors:

- Direction of pull is obstructed
- Direction of pull is not within the indicated area
- Loading ring rests against edges or loads

Although the upper part is ball bearing and rotatable 360°, before usage you should adjust the ring in the correct direction of tension (fig. Permitted directions of pull). That applies in particular when lifting with multi leg slings. With a non-aligned ring (fig. Non-permitted directions of pull), the ring holder could turn suddenly under load, and it comes to high risk for the load and/or people.

The full operating manual contains further details and information on safe usage.

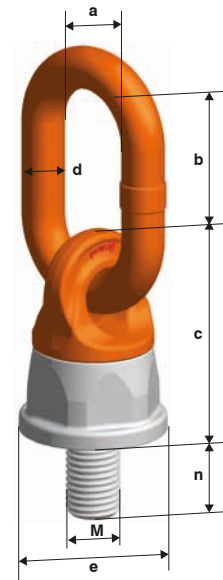

Please refer to the tables with technical data for all corresponding values

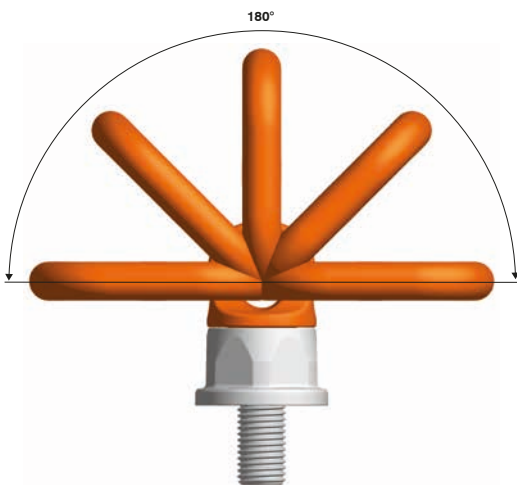

Permitted directions of pull

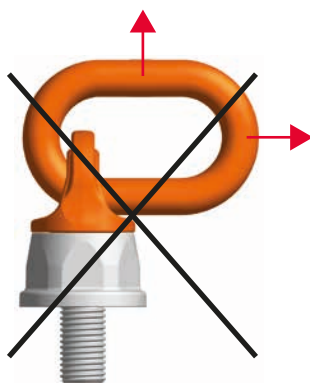

Non-permitted directions of pull

Calculating the required thread length (L):

$$L = H + S + K + X$$

H = Material height

S = Thickness of the washer

K = Height of the nut (depending on the thread size of the screw)

X = Excess length of the screw (twofold pitch of the screw)
L max. = n max.

In addition to the standard and maximum thread lengths, pewag also offers cut-to-length thread lengths. Customised and maximum thread lengths are supplied with a washer and a crack-tested, corrosion-protected screw nut.

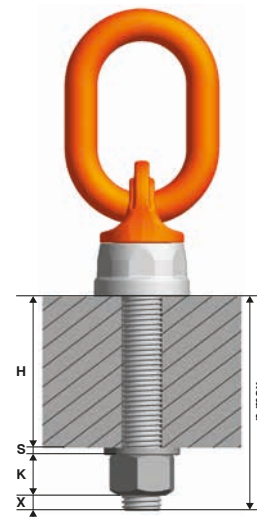

pewag PLDW Delta

Method of lifting
Number of legs
Angle of inclination

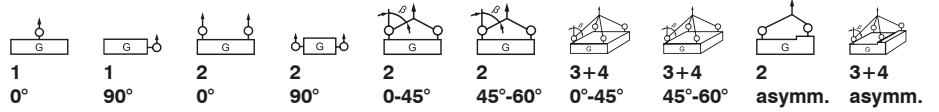

Code	Thread [mm]	Fastening torque [Nm]	Load capacity [kg]									
			600	300	1,200	600	400	300	600	400	300	300
PLDW 0,3 t	M8	10	600	300	1,200	600	400	300	600	400	300	300
PLDW 0,5 t	M10	10	1,200	500	2,400	1,000	700	500	1,000	750	500	500
PLDW 0,7 t	M12	15	1,800	700	3,600	1,400	950	700	1,400	1,000	700	700
PLDW 1 t	M14	25	2,400	1,000	4,800	2,000	1,400	1,000	2,100	1,500	1,000	1,000
PLDW 1,5 t ¹⁾	M16	30	2,800	1,500	5,600	3,000	2,100	1,500	3,100	2,100	1,500	1,500
PLDW 2,5 t ¹⁾	M20	80	5,000	2,500	10,000	5,000	3,500	2,500	5,300	3,500	2,500	2,500
PLDW 4 t ¹⁾	M24	150	7,000	4,000	14,000	8,000	5,500	4,000	8,400	6,000	4,000	4,000
PLDW 6,7 t	M30	230	10,000	6,700	20,000	13,400	9,400	6,700	14,200	10,000	6,700	6,700
PLDW 8 t	M36	450	12,500	8,000	25,000	16,000	11,200	8,000	16,800	12,000	8,000	8,000
PLDW 10 t	M42	600	16,000	10,000	32,000	20,000	14,000	10,000	21,000	15,000	10,000	10,000
PLDW 12 t	M45	600	16,000	12,000	32,000	24,000	16,900	12,000	25,400	18,000	12,000	12,000
PLDW 12,5 t	M48	600	16,000	12,500	32,000	25,000	17,500	12,500	26,200	18,000	12,500	12,500
PLDW 24 t	M56	800	28,000	24,000	56,000	48,000	33,900	24,000	50,900	36,000	24,000	24,000
PLDW 25 t	M64	800	28,000	25,000	56,000	50,000	35,300	25,000	53,000	37,500	25,000	25,000
PLDW M72 ²⁾	M72	-	--	--	-	-	-	-	-	-	-	-
PLDW M80 ²⁾	M80	-	--	--	-	-	-	-	-	-	-	-

¹⁾ Thread length in (), stated in column "n", are also available ex warehouse

²⁾ In development

Safety factor 4

Important: Subject to technical changes!

Straight load direction 0° 	Side load direction „allowed“ (ring aligned) 90° 	Side load direction „not allowed“ (ring not aligned)
Higher load capacity in direction of screw axis (Column „0°“ in load table)	Nominal load capacity perpendicular to screw axis (Column „90°“ in load table)	Not allowed because of unstable condition. Ring could turn suddenly under load – high risk for load and/or people.

Code	Thread [mm]	Load capacity [kg]	a [mm]	b [mm]	c [mm]	d [mm]	e [mm]	n [mm]	n max [mm]	⌀ [mm]	Weight [kg/pc.]
PLDW 0,3 t	M8	300	30	38	54	13	38	20	100	34	0.45
PLDW 0,5 t	M10	500	30	38	54	13	38	20	180	34	0.45
PLDW 0,7 t	M12	700	35	48	54	13	38	22	200	34	0.48
PLDW 1 t	M14	1,000	35	48	54	13	38	22	200	34	0.49
PLDW 1,5 t ¹⁾	M16	1,500	35	48	54	13	38	33 (80)	250	34	0.51
PLDW 2,5 t ¹⁾	M20	2,500	35	55	75	16	55	33 (70)	250	46	1.10
PLDW 4 t ¹⁾	M24	4,000	40	66	82	17	63	40 (100)	300	50	1.50
PLDW 6,7 t	M30	6,700	50	70	92	23	72	40	300	60	2.60
PLDW 8 t	M36	8,000	50	91	124	23	92	55	300	75	4.30
PLDW 10 t	M42	10,000	65	91	124	27	92	60	300	75	5.10
PLDW 12 t	M45	12,000	65	91	124	27	92	68	-	75	5.20
PLDW 12,5 t	M48	12,500	65	116	124	27	92	68	300	75	5.40
PLDW 24 t	M56	24,000	70	105	154	33	110	84	300	95	10.20
PLDW 25 t	M64	25,000	70	105	154	33	110	96	300	95	11.00
PLDW M72 ²⁾	M72	--	-	-	-	-	-	-	-	-	
PLDW M80 ²⁾	M80	--	-	-	-	-	-	-	-	-	

¹⁾ Thread length in (), stated in column "n", are also available ex warehouse

²⁾ In development

Safety factor 4

Important: Subject to technical changes!

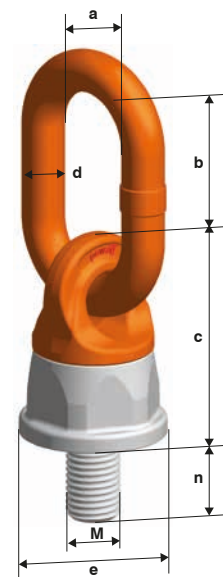

pewag AOR Lashing point

Passed with distinction.

When it comes to reliability, this lashing point won't be beaten. It is perfect for mounting machine parts or vehicle bodies as well as for the hanging of lifting and lashing gear.

Permitted usage

Please refer to the load capacity as stated in the inspection certificate and/or the load capacity table to ensure maximum safety for permitted applications.

Non-permitted usage

During assembly, ensure that improper loading cannot arise due to any of the following factors:

- Direction of pull is obstructed
- Direction of pull is not within the indicated area
- Loading ring rests against edges or loads

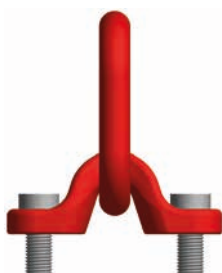
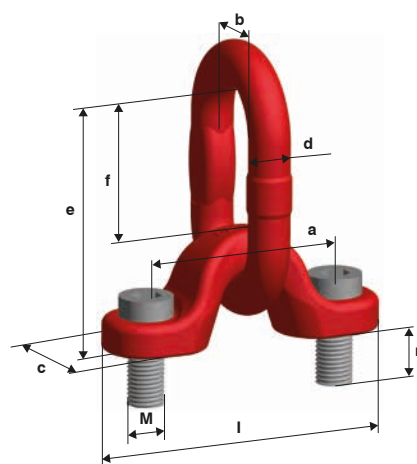

Method of lifting
Number of legs
Angle of inclination

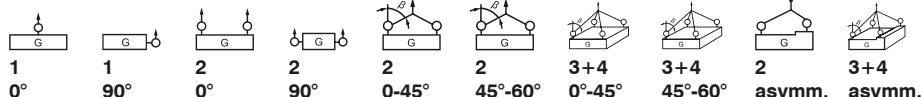

Code	Thread [mm]	Fastening torque [Nm]	Load capacity [kg]									
AOR 10	M16	170	3,150	3,150	6,300	6,300	4,250	3,150	6,700	4,750	3,150	3,150
AOR 13	M20	350	5,300	5,300	10,600	10,600	7,500	5,300	11,200	8,000	5,300	5,300
AOR 16	M30	950	8,000	8,000	16,000	16,000	11,200	8,000	17,000	11,800	8,000	8,000
AOR 22	M36	1,900	15,000	15,000	30,000	30,000	21,200	15,000	31,500	22,400	15,000	15,000
AOR 26 ¹⁾	M42	2,100	21,200	21,200	42,400	42,400	30,000	21,200	45,000	31,500	21,200	21,200
AOR 28 ¹⁾	M45	2,400	25,000	25,000	50,000	50,000	33,500	25,000	50,000	37,500	25,000	25,000
AOR 32 ¹⁾	M56	3,200	31,500	31,500	63,000	63,000	45,000	31,500	67,000	47,500	31,500	31,500
AOR 34 ¹⁾	M56	3,200	36,000	36,000	72,000	72,000	50,000	36,000	75,000	53,000	36,000	36,000

Code	Thread [mm]	Load capacity [kg]	For chain-diameter	a [mm]	b [mm]	c [mm]	d [mm]	e [mm]	f [mm]	l [mm]	n [mm]	Weight [kg/pc.]
AOR 10	M16	3,150	10	90	40	38	18	112	57	130	25	1.41
AOR 13	M20	5,300	13	115	50	48	22	149	79	165	36	2.83
AOR 16	M30	8,000	16	150	65	62	26	183	93	212	50	5.78
AOR 22	M36	15,000	22	175	75	72	36	226	114	255	54	10.90
AOR 26 ¹⁾	M42	21,200	26	200	95	90	45	272	142	295	67	19.30
AOR 28 ¹⁾	M45	25,000	28	200	95	90	45	272	142	295	67	20.20
AOR 32 ¹⁾	M56	31,500	32	230	110	100	48	336	193	330	88	31.70
AOR 34 ¹⁾	M56	36,000	34	230	110	100	48	336	193	330	88	31.70

¹⁾ Not a stock item
Important: Subject to technical changes!

pewag RGS Eyebolt

Always the perfect choice.

This high-strength RGS eyebolt is ideal for lifting machine parts. Eyebolts may only be tightened manually and are not suitable for diagonal pull. However, they cannot be beaten when it comes to quality.

Permitted usage

For load capacities in the permitted directions of pull (fig.: Permitted usage) please refer to the load capacity table.

Non-permitted usage

During assembly, ensure that improper loading cannot arise due to any of the following factors:

- Direction of pull is obstructed
- Direction of pull is not within the indicated area (fig.: Non-permitted usage)

Please note that the RGS eyebolt may only be placed under load in the direction of pull! For those methods of lifting please use the screwable eyebolts PLGW or screwable lifting points PLAT, PLBW or PLDW.



Permitted usage



Non-permitted usage

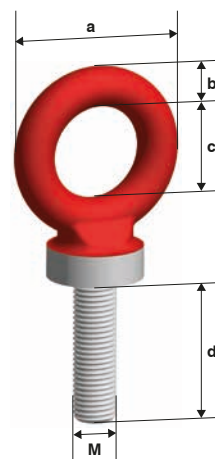

Code	Thread [mm]	Load capacity 1-leg 0° [kg]	Load capacity 2-leg 0° [kg]	a [mm]	b [mm]	c [mm]	d [mm]	Weight [kg/pc.]
RGS 8	M8	400	800	34	7	20	24	0.05
RGS 10	M10	700	1,400	38	8	22	30	0.10
RGS 12	M12	1,000	2,000	47	10	26	36	0.14
RGS 14	M14	1,200	2,400	57	14	29	40	0.25
RGS 16	M16	1,500	3,000	65	14	35	55	0.36
RGS 18	M18	2,000	4,000	65	14	35	54	0.38
RGS 20	M20	2,500	5,000	73	16	39	59	0.55
RGS 22	M22	3,000	6,000	82	19	44	64	0.74
RGS 24	M24	4,000	8,000	95	20	54	84	1.12

Safety factor 4

Additional size available upon request!
Important: Subject to technical changes!

Weldable hooks and lifting points

Product overview

Content

Benefits at a glance	44
AWHW Weld-on hook	45
PLEW pewag winner profilift eta	46-47
PLE/N pewag profilift eta	48-49





pewag – progressive, innovative and reliable

State-of-the-art technology for benefits that carry plenty of weight

Our experience goes back centuries, and throughout our history, pewag has worked on the basis of three principles: progression, innovation and reliability – in short, the factors that are reflected in every single one of our products.

pewag lifting points are products that stand out for their excellent compatibility with the globally successful pewag lifting chain programme and that make it even more versatile and flexible. Guaranteed ease-of-use when it comes to assembly and application is part of the pewag standard.

The weldable PLE lifting point complies with the Machine Directives 2006/42/EC and has been tested according to EN 1677-1 and BGR 500. Load capacities are clearly marked on the welding pad.

All welding operations comply with the provisions of DIN EN ISO 14341 and must be performed by welders with a valid qualification according to EN 287-1 respectively EN ISO 9606-1 (PLEW). The lifting points are delivered in individual packaging units, complete with user information and welding instructions.

Load capacities will vary according to the type of application, number of legs and angle of inclination and are listed in tables that form an integral part of the detailed user manual corresponding to the Machine Safety Regulation 2010 and the Machine Directive. Each lifting point comes with a full operating manual.



PLE stamp

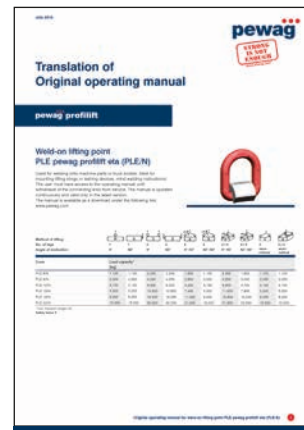

Operating manual



DGUV test certification

pewag AWHW Weld-on hook

Welding for winners.

This high-strength hook is particularly well suited for welding onto excavator bucket, spreader beams etc. Its outstanding features include a die-forged, tempered safety catch, making it extrarobust. As the safety catch locks into the tip of the hook, it provides excellent protection against lateral shifting.

The product is manufactured according to EN 1677-1 with a higher load capacity. Attention should be paid to the delivered operating manual and to the welding instructions. A CE-marking further emphasises the superior quality of this product. Replacing the SFGW-A safety catch set is easy and quick, without the need for special tools.



AWHW Weld-on hook

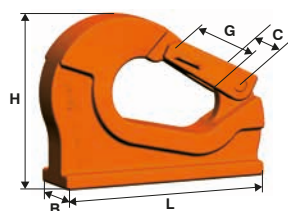

Code	Load capacity [kg]	L [mm]	H [mm]	G [mm]	B [mm]	C [mm]	Weight [kg/pc.]
AWHW 1,3	1,300	95	74	25	25	34	0.67
AWHW 3,8	3,800	132	106	29	35	40	1.40
AWHW 6,3	6,300	167	133	34	45	49	2.95
AWHW 10	10,000	175	136	34	50	49	4.02

pewag PLEW Eta

Keeps its promise.

High-tensile lifting point pewag winner profilift eta, for welding onto machine parts or vehicle bodies. Ideal for hanging of lifting and lashing parts. Due to the integrated spring, the ring will be kept in each requested position.

The PLEW has a higher rated capacity than the pewag PLE/N and additionally can be loaded higher in the preferred load direction (see user manual). The grooves on the weld-on bracket at 45° and 60° simplify the recognition of the permitted inclination.

Each lifting point comes with an individual serial number. Also available with peTAG upon request.

The instructions according to DIN EN ISO 14341 are valid for the welding. The welding may only be carried out by a welding operator with a valid qualification according to EN 287-1 or EN ISO 9606-1.

The lifting points will be packed individually and together with a user manual and welding instructions.

Permitted usage

Load capacity acc. to the inspection certificate respectively table of WLL in the mentioned directions of pull (fig.: Permitted directions of pull)

Non-permitted usage

Make sure when choosing the assembly that improper load can not arise e.g. if:

- the direction of pull is obstructed
- direction of pull is not in the foreseen area
- loading ring rests against edges and load

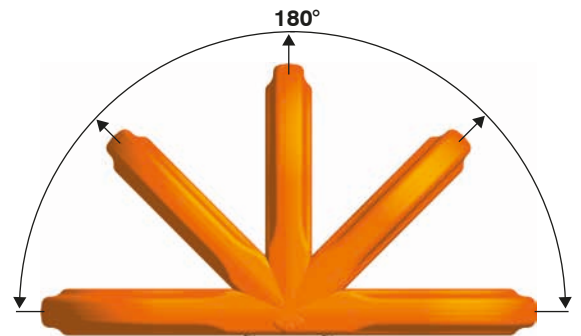

Permitted directions of pull



Permitted directions of pull

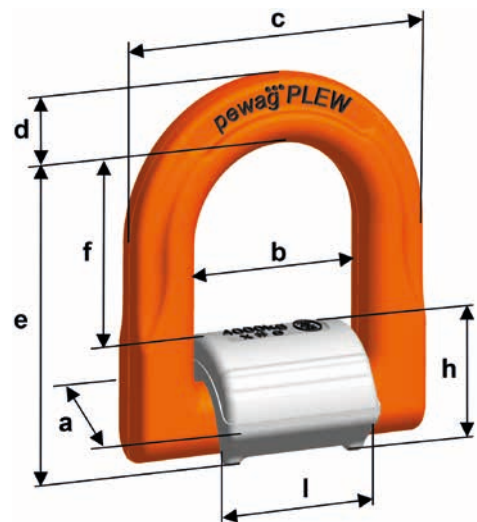

Method of lifting										
Number of legs	1	1	2	2	2	2	3+4	3+4	2	3+4
Angle of inclination	0°	90°	0°	90°	0-45°	45°-60°	0°-45°	45°-60°	asymm.	asymm.

Code	Load capacity [kg]									
PLEW 1,5 t	2.500	1.500	5.000	3.000	2.100	1.500	3.100	2.200	1.500	1.500
PLEW 2,5 t	4.000	2.500	8.000	5.000	3.500	2.500	5.300	3.700	2.500	2.500
PLEW 4 t	6.000	4.000	12.000	8.000	5.600	4.000	8.400	6.000	4.000	4.000
PLEW 6,7 t	10.000	6.700	20.000	13.400	9.400	6.700	14.200	10.000	6.700	6.700
PLEW 10 t	15.000	10.000	30.000	20.000	14.100	10.000	21.200	15.000	10.000	10.000
PLEW 19 t ¹⁾	25.000	19.000	50.000	38.000	26.800	19.000	40.300	28.500	19.000	19.000

Code	Load capacity [kg]	a [mm]	b [mm]	c [mm]	d [mm]	e [mm]	f [mm]	h [mm]	l [mm]	Weight [kg/pc.]
PLEW 1,5 t	1.500	32	38	65	14	65	40	25	35	0,32
PLEW 2,5 t	2.500	37	44	75	16	76	47	28	41	0,50
PLEW 4 t	4.000	43	48	84	18	83	51	32	45	0,75
PLEW 6,7 t	6.700	58	60	107	24	108	64	44	56	1,70
PLEW 10 t	10.000	69	66	126	27	123	69	54	61	2,80
PLEW 19 t ¹⁾	19.000	92	95	171	38	168	100	68	89	6,50

¹⁾ The spring only assists the weld-on process. It does not hold the ring in each position.

Straight load direction 0°	Side load direction recommended (ring aligned) 90°	Side load direction possible (ring not aligned)
Higher load capacity perpendicular to welding surface (column „0°“ in load table)	Nominal load capacity parallel to welding surface (column „90°“ in load table)	Application possible with nominal load. It is better to weld in a way, so that the ring is loaded in the folded direction (as shown next to it).

pewag PLE/N Eta

Tried-and-tested for pull in every direction.

Welding onto machine parts or vehicle bodies requires special products that are ideally suited for the hanging of lifting and lashing parts – and PLE pewag proflift eta (grade 8) is one of them. In fact, the product has made a name for itself among highstrength weldable lifting point, also for its integrated spring that keeps the ring in any position that is required. The product may be loaded in all directions.

Permitted usage

For load capacities in the permitted directions of pull (fig. Permitted usage and permitted direction of pull), please refer to the load capacity table.

Non-permitted usage

During assembly, ensure that improper loading cannot arise due to any of the following factors:

- Direction of pull is obstructed
- Direction of pull is not within the indicated area
- Loading ring rests against edges or loads

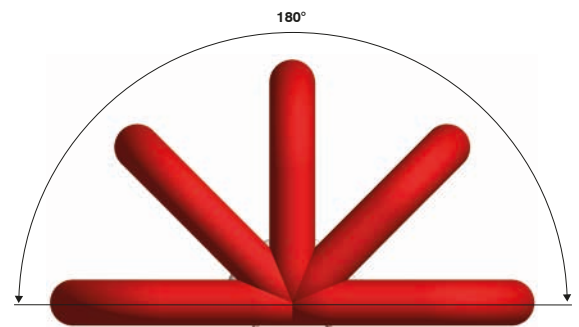

Permitted direction of pull

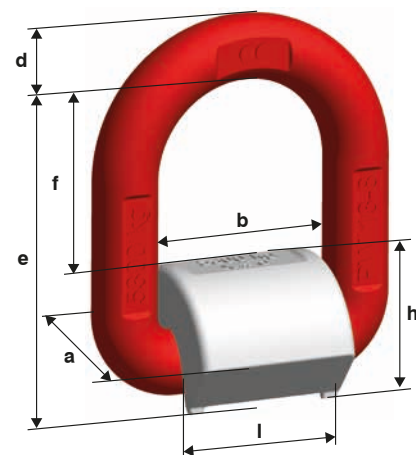

Method of lifting										
Number of legs	1	1	2	2	2	2	3+4	3+4	2	3+4
Angle of inclination	0°	90°	0°	90°	0-45°	45°-60°	0°-45°	45°-60°	asymm.	asymm.

Code	Load capacity [kg]									
	1	2	3	4	5	6	7	8	9	10
PLE/N 6	1.120	1.120	2.240	2.240	1.500	1.120	2.300	1.600	1.120	1.120
PLE/N 8	2.000	2.000	4.000	4.000	2.800	2.000	4.200	3.000	2.000	2.000
PLE/N 10	3.150	3.150	6.300	6.300	4.400	3.150	6.600	4.700	3.150	3.150
PLE/N 13	5.300	5.300	10.600	10.600	7.400	5.300	11.200	7.900	5.300	5.300
PLE/N 16	8.000	8.000	16.000	16.000	11.300	8.000	16.900	12.000	8.000	8.000
PLE/N 22	15.000	15.000	30.000	30.000	21.000	15.000	31.800	22.500	15.000	15.000

Code	Load capacity [kg]	a [mm]	b [mm]	d [mm]	e [mm]	f [mm]	h [mm]	l [mm]	Weight [kg/pc.]
PLE/N 6	1.120	36	40	11	67	42	26	35	0,31
PLE/N 8	2.000	37	42	13	73	45	28	37	0,40
PLE/N 10	3.150	41	45	16,50	80	47	34	40	0,63
PLE/N 13	5.300	61	55	22	97	53	44	50	1,46
PLE/N 16	8.000	63	70	25	120	73	48	64	2,30
PLE/N 22	15.000	89	97	33	163	92	70	90	5,40

Safety factor 4

Important: Subject to technical changes!

Straight load direction 0°	Side load direction recommended (ring aligned) 90°	Side load direction possible (ring not aligned)
Nominal load capacity perpendicular to welding surface (column „0°“ in load table)	Nominal load capacity parallel to welding surface (column „90°“ in load table)	Application possible with nominal load. It is better to weld in a way, so that the ring is loaded in the folded direction (as shown next to it).

Hardened shell –
intelligent core

peTAG solution

A pewag solution that inspires.

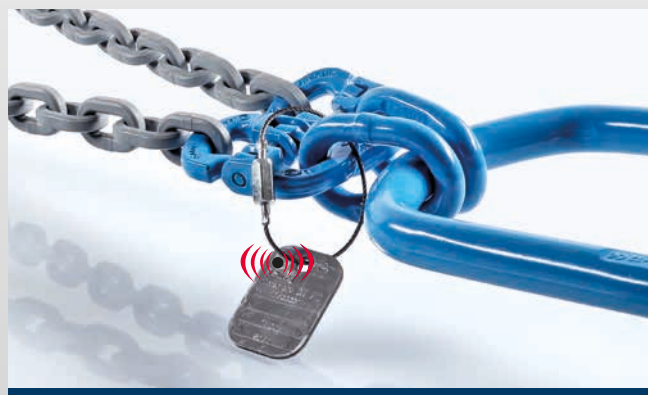
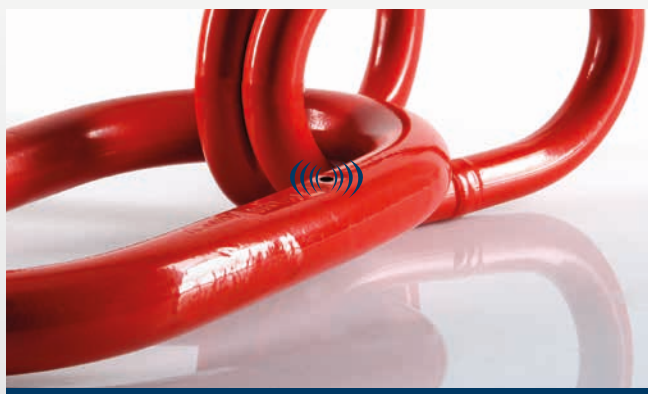

Interested?
peTAG@pewag.com

Your Challenges – Customised solutions by pewag.

We develop safe and user-friendly special solutions according to your requirements. No matter if you need

- modifications to the thread (pipe thread, internal thread or locking pin),
- special versions (customised colour, reduced contact area, etc.), or
- welded adaptations (welded hook, weldable lifting points on a screw-on plate, ...),

we are happy to advise you and look forward to your inquiry.

liftingpoints@pewag.com



Anchorage points – Fall protection

Product overview

Content

PLGW-PSA Fall protection anchorage eye bolt 54-55





pewag PLGW-PSA Fall protection

Fall protection anchorage eye bolt.

The pewag PLGW-PSA anchorage point is part of the anchorage system on which personal fall protection equipment can be fastened. It was designed and certified as per the high safety requirements for personal protective equipment according to the EG-Regulations 89/686/EWG; and meets already the new EN795:2012 (1 person) and CEN/TS 16415 (2 persons) norms respectively. For more information, please consult the operating instructions.

The PLGW-PSA is available in „Basic“ and „Supreme“: PLGW-PSA Basic is intended for permanent assembly to the anchorage system (e.g. tripod) and is mounted using a commercial Allen key. The PLGW-PSA Supreme version has a patented system which allows for tool-free assembly and disassembly once the anchorage point is no longer in use and needs to be removed. You can find more information on the functionality either by watching the video on our homepage (www.pewag.com) or by reading the operating instructions.

The special finish using the colour RAL 1003 for both versions is approved for use with stationary antenna systems („cell phone towers“). The pewag PLGW-PSA anchorage point is available in the sizes M12 (for 1 person) as well as M16 and M20 (for max. 2 persons). All sizes are obtainable with individual thread lengths.

Every anchorage point is marked with the thread size and the permitted number of persons. The individual serial number enables complete documentation on all compulsory inspections.



pewag PLGW-PSA supreme

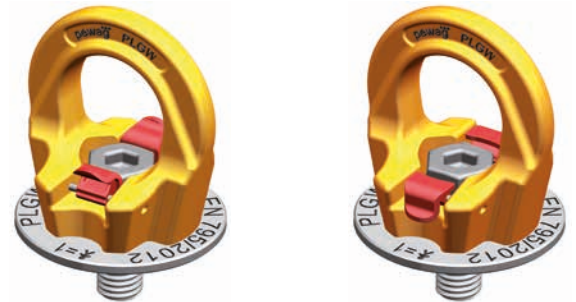

PLGW-PSA supreme rotatable

PLGW-PSA supreme disassembly



pewag PLGW-PSA basic



Assembly video PLGW

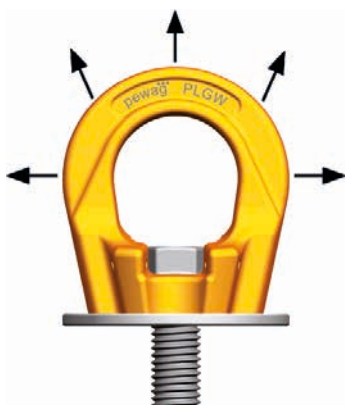

Permissible pull directions that occur when used correctly.

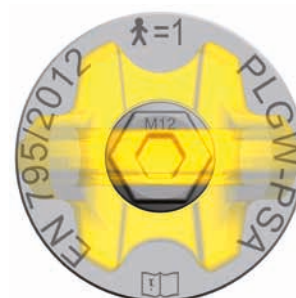

Identification on Sleeve and Screw.
Component description and location of identification details on product.

Code	Thread [mm]	Persons	a [mm]	b [mm]	c [mm]	d [mm]	e [mm]	f [mm]	n [mm]	n max [mm]	Hexagon [mm]	Weight [kg/pc.]
PLGW PSA M12	M12	1	30	55	12	32	63	55	20	160	8	0.30 / 0.42
PLGW PSA M16	M16	2	35	64	14	36	70	62	25	160	10	0.47 / 0.69
PLGW PSA M20	M20	2	40	73	16	41	81	66	30	160	12	0.60 / 0.95

Note: The data stated in column Weight [kg/pc.] refer to the standard length (n [mm]) and to the maximum length (n max [mm]).
Attention: Subject to technical modifications!

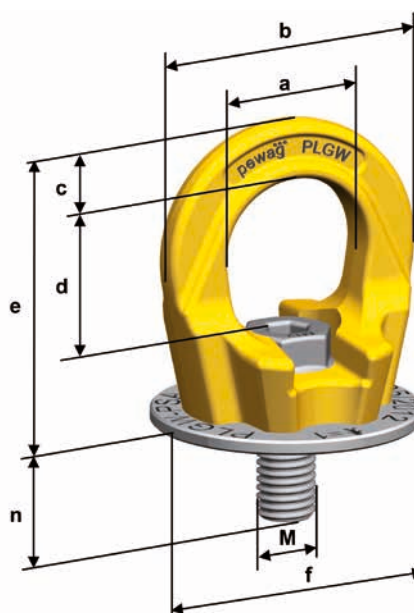

PLGW-PSA basic

Spare parts

Product overview

Content

PLMS Screw nut according to DIN 980 V (incl. washer)	58
PLGS Screw for PLGW	58
PLGES Spare latches set	59
PLAS Screw for PLAW	59
PLBS Screw for PLBW	60
PLGIS Allen key set	60
ALP Thread adapter	61
SFGW-A Safety catch set	61

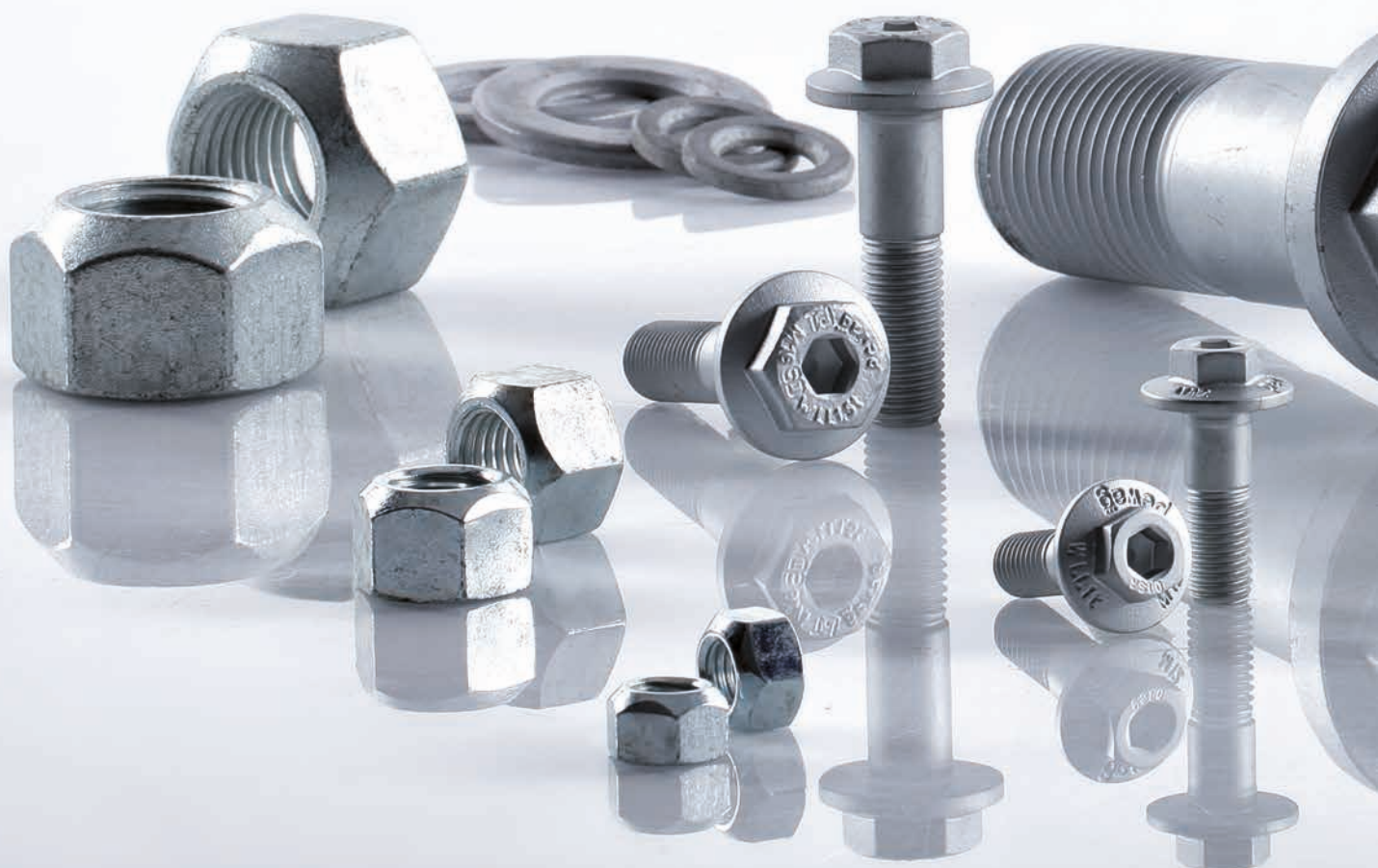



pewag PLMS Screw nut

Complies with DIN 980 V.
Washer included.

This set is often used for pewag winner lifting points with customised lengths. The nut is crack-tested and manufactured according to DIN 980 V in strength category 10. Set includes nut and washer.



PLMS Screw nut	Code	Thread [mm]	Pitch P [mm]	SW [mm]	K [mm]	S [mm]	VPE [piece]
	PLMS 8	M8	1.25	13	8	1.60	10
	PLMS 10	M10	1.50	17	10	2	10
	PLMS 12	M12	1.75	19	12	2.50	10
	PLMS 14	M14	2	22	14	3	10
	PLMS 16	M16	2	24	16	3	10
	PLMS 18	M18	2.50	27	18	4	10
	PLMS 20	M20	2.50	30	20	4	10
	PLMS 24	M24	3	36	24	4	10
	PLMS 30	M30	3.50	46	30	5	4
	PLMS 36	M36	4	55	36	6	1
	PLMS 42	M42	4.50	65	42	7	1
	PLMS 48	M48	5	75	48	8	1
	PLMS 56	M56	5.50	85	56	10	1
PLMS 64	M64	6	95	64	10	1	

pewag PLGS Screw for PLGW

For metric threads.

This screw is one of the spare parts for the PLGW pewag profilift gamma lifting point with a metric thread.



PLGS Screw for PLGW	Code	Thread [mm]	VPE [piece]
	PLGS 0,3 t	M8	10
	PLGS 0,5 t	M10	10
	PLGS 0,7 t	M12	10
	PLGS 1,5 t	M16	10
	PLGS 2,3 t	M20	10
	PLGS 3,2 t	M24	10
	PLGS 4 t	M30	4
	PLGS 7 t	M36	1
	PLGS 9 t	M42	1
	PLGS 12 t	M48	1

pewag PLGES Spare latches set

As good as the original.

The spare latches set for the PLGW pewag profilift gamma supreme is available now.

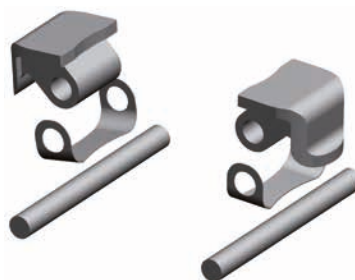

PLGES Spare latches set



Code	Thread [mm]	VPE [pair]
PLGES 0,3 t	M8	1
PLGES 0,5 t	M10	1
PLGES 0,7 t	M12	1
PLGES 1,5 t	M16	1
PLGES 2,3 t	M20	1
PLGES 3,2 t	M24	1
PLGES 4 t	M30	1
PLGES 7 t	M36	1
PLGES 9 t	M42	1
PLGES 12 t	M48	1

pewag PLAS Screw for PLAW

Something up your sleeve.

pewag spare parts are guaranteed to pass any quality test – and the PLAS screw for the PLAW lifting point is no exception. pewag profilift alpha with metric thread. Suitable for the PLAW type with sleeve.



PLAS Screw for PLAW



Code	Thread [mm]	VPE [piece]
PLAS 0,3 t	M8	10
PLAS 0,63 t	M10	10
PLAS 1 t	M12	10
PLAS 1,5 t	M16	10
PLAS 2,5 t	M20	10
PLAS 4 t /13 ¹⁾	M24	10
PLAS 6 t	M30	4
PLAS 8 t	M36	1
PLAS 10 t	M42	1
PLAS 15 t	M42	1
PLAS 20 t	M48	1

¹⁾ Only available for new model version

pewag PLBS Screw for PLBW

The perfect match.

This screw is one of the spare parts for the PLBW pewag profilift beta lifting point with a metric thread.



PLBS Screw for PLBW	Code	Thread [mm]	VPE [piece]
	PLBS 0,3 t	M8	10
	PLBS 0,6 t	M10	10
	PLBS 1 t	M12	10
	PLBS 1,3 t	M14	10
	PLBS 1,6 t	M16	10
	PLBS 2 t	M18	10
	PLBS 2,5 t	M20	10
	PLBS 3 t	M22	10
	PLBS 4 t	M24	10
	PLBS 5 t	M27	4
	PLBS 6,3 t	M30	4
	PLBS 8 t	M33	2
	PLBS 10 t	M36	1
	PLBS 12,5 t	M42	1
	PLBS 15 t	M48	1

pewag PLGIS Allen key set

Easy and safe application.

The assembly of the PLGW basic is only possible with tools. Special Allen key for the PLGW basic M8 up to M20 simplify the mounting process. The keys are available as a complete set and they are marked with both: size and tightening torque.

The PLGW supreme is designed for tool-free mounting.



pewag ALP Thread adapter

Exceptionally well adapted.

Loads often come with tapped holes for DIN-580 eyebolts. The thread adapter can be mounted using a commercial open-jawed spanner; the pewag lifting point is then mounted according to the instruction manual.

By using the pewag thread adapter, the high-strength pewag lifting points (PLAW, PLBW, PLGW, PLDW) can replace the standard eyebolts.

The thread adapter can be mounted using a commercial open-jawed spanner; the pewag lifting point is then mounted according to the instruction manual. The permitted load capacity corresponds to the pewag lifting point fitted in the internal thread.

Available upon request only!



pewag SFGW-A Safety catch set

Good at their job.

These SFGW-A safety catch sets with die-forged and powder coated safety catch and a spring from rust-proof spring steel are all about safety and security.

They are suitable for pewag winner accessories. The safety catch sets are in a league of their own – even the tiniest pewag parts offer outstanding quality!

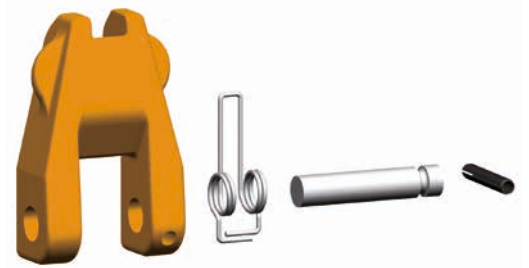

SFGW-A Safety catch set

Code

For accessory part

SFGW-A 1

AWHW 1.3

SFGW-A 3

AWHW 3.8

SFGW-A 6

AWHW 6.3, AWHW 10



User information

for lifting points

User information

User information

64-65





User information

Information and safety guidelines on usage, storage, inspection and servicing of pewag winner lifting points.

General information

pewag winner profilift lifting points are quality products that are suitable for a wide range of general lifting purposes, including different designs, types of load and application modes. For detailed information on designs and classification of load capacities, please refer to the tables in this catalogue.

Responsibility is key

If the pewag winner profilift lifting points are used correctly and by competent persons, they have a long lifespan and provide the highest possible safety standards. Material and personal damage can be avoided by reading this user information carefully and handling all lifting processes in a responsible, provident manner.

Please note that all operating manuals that come with the product must be complied with at all times!

Changes to the condition as delivered

Only the original parts provided in the delivery may be used to complete the installation.

Modifying the original condition by grinding, welding (with the exception of the weldable lifting points), drilling, stamping etc. is not permitted and means exposing yourself and others to unnecessary danger. In such a case, safety can no longer be guaranteed and usage becomes dangerous. pewag does not accept any liability in such cases. Do not apply any surface coatings, i.e. do not subject parts to hot galvanizing or electrogalvanizing.

Cleaning processes that rely on dipping or removing a coating with chemicals are potentially dangerous processes that may give rise to hazards. We recommend consulting pewag prior to performing these processes. The welding seam of the weldable lifting points are best protected against corrosion by applying a varnish.

Correct usage of the lifting points

If used correctly, pewag winner profilift lifting points are safe and powerful. Please note that they may only be used by authorised personnel who have received sufficient training. Correct usage is subject to the following principles:

The location point of the load must be chosen in such a way that the transmitted forces of the base material can be absorbed without any deformations. Prior to loading, the

load bracket needs to be adjusted in the direction of pull. Non-permissible strains such as twisting or rotating the load must be avoided. Please ensure that the lifting gear can be mounted and demounted without any risk of injury!

Damages to the load, lifting gear or lifting can be avoided by proper positioning. In cases where a single lifting point is used, this has to be mounted flat over the centre of gravity of the load. When using two lifting points (2-leg chain sling), these have to be mounted symmetrically on both sides of the centre of gravity of the load. When using 3 or 4 lifting points (3 or 4-leg chain sling), these have to be mounted evenly on one level surrounding the centre of gravity of the load. Care must be taken to ensure that the load is evenly spread among the individual chain legs.

In case of asymmetrical load distribution, the load capacity must be reduced in accordance with the load capacity table supplied. This may result in having to use a lifting point of the next highest load capacity. Use of acids and caustic solutions or exposure to their vapours is not permitted. Please be aware of this requirement at all times as certain production processes release acids and/or vapours! The load capacity will also be reduced if the lifting points are exposed to higher temperatures. Please comply with the supplied operating instructions at all times. For further information, please contact the pewag technical service team.

Screwable lifting points

We recommend the following minimum screw thread depth:

- 1 x M for steel (M = thread size, for instance M16)
- 1.25 x M for cast steel
- 2 x M for aluminium

To ensure safe usage, the thread size and thread length for materials of lower strength, like light metals, non-ferrous metals or cast iron, must be chosen in such a way that the occurring loads may be absorbed by the lifting point. Impact loading or vibration may cause the screw to become loose. To avoid this, apply a liquid threadlock such as Loctite.

If using additional tools of this sort, please follow the manufacturer's instructions. pewag accepts no liability if components are used that are not part of the pewag range (e.g. screws).

Please check the following points prior to each usage:

- All screws are sufficiently tightened and the fastening torque corresponds to that specified in the operating manual
- The lifting point is complete, i.e. no components are missing
- The stamp of the lifting point is clearly legible
- The lifting point shows no signs of damage such as notches, cracks, deformations, wear, strong corrosion, surface cracks on load-bearing parts, noticeable signs of excessive heat exposure (such as burnt varnish, discolouration of the base material)
- The rotatable lifting points may be rotated freely and smoothly

In addition, check before each assembly:

- Screws and threads are not damaged
- Screw size, screw grade and screw depth are correct

The supplied operating manual must be complied with at all times!

If in doubt or in case of visible damage, the lifting point must be decommissioned and inspected by a competent person. This also applies to unusual events, for instance uncontrolled exposure to heat.

Weldable lifting points

For welding, the following instructions apply:

- All welding processes must be performed by a qualified welder according to EN 287-1 respectively EN ISO 9606-1
- The material of the weldable lifting points can be obtained from the enclosed operating manual
- The surface of the welding area must be thoroughly cleaned before welding. Rust and scale, paint, oil or similar must be removed
- Contact between the coated bracket and the welded material must be avoided

Please check the following points prior to each usage:

- The stamp of the lifting point is clearly legible
- The lifting point shows no signs of damage such as notches, cracks, deformations, wear, strong corrosion, surface cracks on load-bearing parts, noticeable signs of excessive heat exposure on the coated bracket (such as burnt varnish, discolouration of the base material)
- No surface cracks or damage along the welding seam

The supplied operating manual must be complied with at all times!

If in doubt or in case of visible damage, the lifting points must be decommissioned and inspected by a competent person. This also applies to unusual events, for instance uncontrolled exposure to heat.

Correct maintenance

The maintenance of pewag winner profilift lifting points must be performed by competent persons. Improper use or use by unauthorised persons must be avoided at all times.

Prevention is better than cure!

Prior to using a lifting point, it must be verified whether the lifting point was inspected every 12 months by a competent person and in accordance with applicable national standards.

If the chain sling is frequently used at its full load capacity, more frequent inspections are required! All inspections must be documented, in particular with regard to results and servicing activities. These records must be kept throughout the service life of the lifting points.

A sample for the documentation can be downloaded from www.pewag.com.

Clean storage

pewag winner profilift lifting points must always be stored in a clean and dried condition and protected against corrosion, i.e. slightly lubricated.

The thread shafts must be protected from damage using appropriate means.

Important

With the exception of the RGS eyebolt, all pewag winner profilift lifting points may also be used as lashing points. The admissible lashing capacity is double the nominal load capacity, as a 2-fold safety factor applies to the securing of loads. For the PLBW lifting points, a 2.5-fold safety factor applies as lifting operations require a safety factor of 5. We recommend consulting the pewag technical service prior to using the lifting points as lashing points.

Example:

PLE/N 8 = 2,000 kg load capacity for lifting operations. As lashing point LC = 4,000 daN admissible lashing capacity

Please refer to our website www.pewag.com for detailed information on load capacities, measures and 3D models (section Lifting/Lifting Points). Each lifting point comes with a detailed operating manual in two languages.

Detailed original operating manuals for all our pewag quality products are available for download at www.pewag.com.

Our manuals are subject to a continuous improvement process to ensure that they are always up to date. For this reason, always refer to the latest version of a manual.



Learning services for
education and
training

pewag academy

Product and technology training, e-learning, blended learning

The individual courses impart comprehensive knowledge on pewag products and technologies.

These courses provide added value for companies and participants, since they can be used or acknowledged within the framework of training prescribed by law.



“
Knowledge
for **you**
”



Intermedial teaching material

Visualisation of training content with videos and animations



Anytime

Independent of time and place

Unrestricted access to training content (videos, articles etc.) in the respective area of training on the pewag academy portal



Anywhere

Intermedial teaching content is also available on smartphone or tablet



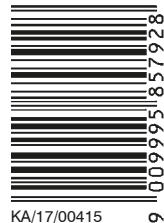

KA/17/00415



www.pewag.com

pewag austria GmbH

A-8041 Graz, Gaslaternenweg 4, Phone: +43 50 50 11-0, Fax: +43 50 50 11-100,
saleinfo@pewag.com, www.pewag.com

