

CAME-TV

# User Manual

## Tioga Series

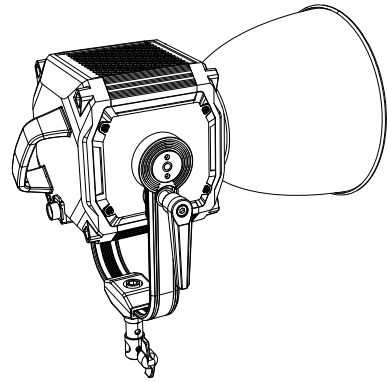

660D | 660B



## I. Introduction

1. 660D, 600B feature high-power COB LEDs with a lifespan of up to 50,000 hours. These LEDs have a standard color temperature with a CRI & TLCI  $\geq 95$ .
2. Built-in NTC temperature detection to automatically control the fan and prevent overheating to ensure a long product life.
3. Dimmable 0-100% and flicker-free due to the PWM integrated design.
4. 11 pre-installed special effect modes, to help you create the perfect scene. In each mode, brightness and speed are adjustable. And for 600B, the color temperature is adjustable as well.
5. Optional battery power via V-lock battery mounts on control box.
6. Software updates via USB.
7. Available control option: control box, DMX console, remote control or mobile phone APP.
8. Use any Bowens mount accessory, such as the included custom designed standard reflector.
9. Solid aluminum shell provides durability and enhanced heat dissipation for a long product life.
10. 360° adjustable, all metal U-bracket featuring disc brake locking function for safely mounting and achieving any angle needed.
11. LED heat prevention technology ensures that your light will emit steady and accurate light under varying conditions.
12. The LCD displays real-time data for color temperature and brightness.
13. Suitable for indoor and outdoor photography and videography. Great for studio and location shoots including TV, film, portrait photography and more.

## II. Precaution

1. ALWAYS remove the protective cover before using your light.
2. ALWAYS press accessory lock button on the bottom of the light when removing accessories such as the standard reflector, barn doors or optional zoom lens. Failure to do so may damage your light.
3. During use, avoid dirt or debris from contacting the surface of the COB LED to prevent damage to the light.
4. HOT! DO NOT TOUCH! Keep flammable substance at least 4 inches (100mm) away from the surface of the LED.
5. Do not block the heat dissipation vents on light body. Blocking these will inhibit airflow, causing the unit to overheat and stop working. This may shorten the lifespan of the light.
6. Do not operate with wet hands, doing so may cause electric shock.
7. Do not operate in environments near flammable gases or volatile liquids as this may increase the risk of explosion/fire.
8. Do not operate in enclosed spaces where heat buildup can be extreme, such as a car on a sunny day. The increased heat will trigger the auto heat protection function and affect use. Frequent overheating may cause premature failure of the light unit.
9. Do not damage, disassemble, twist or modify the power cord as it may increase the risk of fire or electric shock.
10. Do not place under heavy objects.
11. Keep the light surface clean with a soft, dry cloth. If build-up is noticeable, use isopropyl alcohol on a soft, clean cloth to gently remove debris. Ensure the LED is off and cool, then wipe gently WITHOUT pressing on the surface of the COB LED.
12. ONLY use the power control box provided with this product. Should you need a replacement, please contact us.
13. Avoid impact to the LCD screen; impact may damage it.
14. Use the safety cable when hanging the fixture.
15. When using the accessories, please ensure that they are properly and securely installed. Improperly installed accessories may fall and become damaged.



### III.Part Name

light :

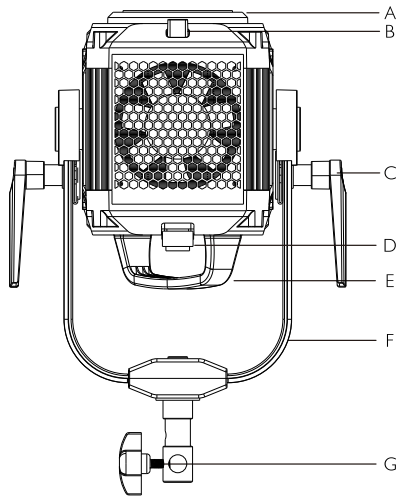

- Ⓐ Bowen mount
- Ⓑ Bowens mount accessory lock button
- Ⓒ Angle adjustment & locking handle
- Ⓓ DC power input socket
- Ⓔ Integrated carrying handle
- Ⓕ U-type bracket
- Ⓖ Stand mount locking screw

power control box:

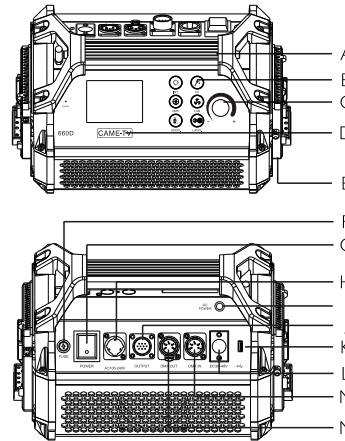

- Ⓐ Power control box handle
- Ⓑ Menu buttons
- Ⓒ Multi-function interface dial/button
- Ⓓ LCD screen
- Ⓔ V-lock battery plate
- Ⓕ Fuse
- Ⓖ Power button
- Ⓗ AC Power input socket
- ⓫ DC power
- ⓫ DC output socket
- ⓬ USB port
- ⓫ DC input socket ( DC36-48V)
- ⓬ DMX IN socket
- ⓬ DMX OUT socket

Menu buttons on the power control box:

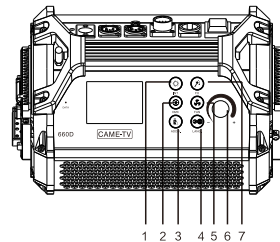

- ① INT(brightness) button (660D)  
CCT (Color temperature) button ( 660B)
- ② DMX button
- ③ Addr. Settings (Address setting) button
- ④ Lang.(Language) button
- ⑤ Fan button
- ⑥ Multi-function interface dial/button
- ⑦ FX (Special effect) button



## IV.Usage

### Set up instructions:

#### 1. Removal and installation of protective cover

Press the Bowens mount accessory lock button of the light in the direction of the arrow shown in the figure, and at the same time turn the protective cover / standard reflector counterclockwise and pull it out, and turn it clockwise if you want to install the protective cover /standard reflector.

NOTE:ALWAYS remove the protective cover before using your light.

When the light is not in use, install the protective cover to protect the light from dirt or debris.

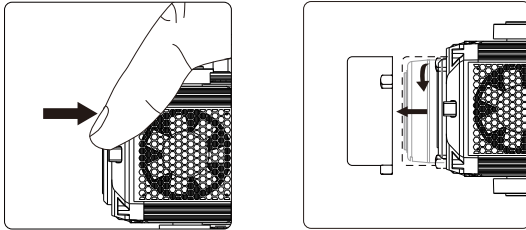

#### 2.Installation and removal of the standard reflector.

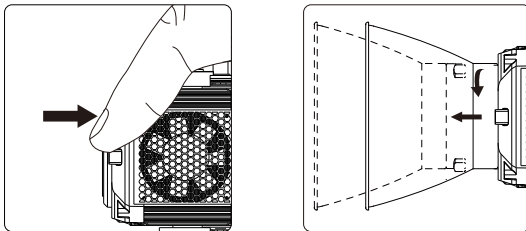

#### 3.How to set up the light

(1)To mount on light support or stud: Loosen the stand mount locking screw by turning counterclockwise. Place the mount on the light stand and secure the screw by turning clockwise. Please ensure the light stand is fully mounted onto the light support and the screw is securely fastened.

(2)When mounting to a 1 1/8" (junior) stud, it will be necessary to remove the set screw using an M4 hex wrench.

(3)Adjust the light to the desired angle by loosening the angle adjustment and locking handle by turning counterclockwise. Move the light to the desired position, then tighten the angle adjustment and locking handle by turning clockwise.

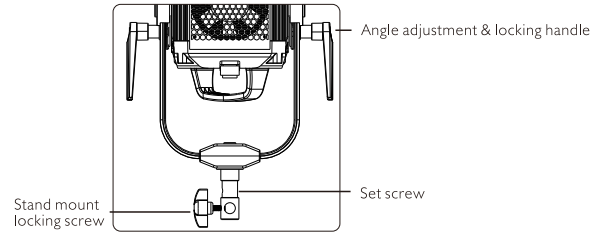

#### 4.How to set up the power control box

(1)Use the connecting cable to connect the light body to the power control box ,align the red dots on the plug and socket, and then insert the plug to the socket. To unplug , pull up the collar of the connector to release its locking mechanism and disconnect it.

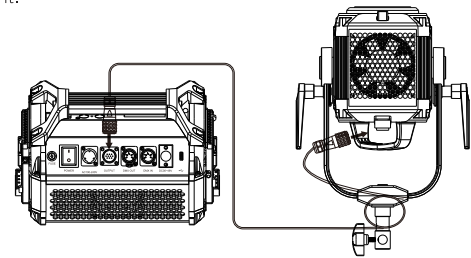

(2) Connect the AC power cable to the power control box via the AC power socket, align it with the locking slot as shown in the figure below, and then insert the power plug. Connect the AC power cable to the external power supply( AC100-240V). To remove the AC power cable, press down the spring lock and turn counterclockwise, and then pull it out.

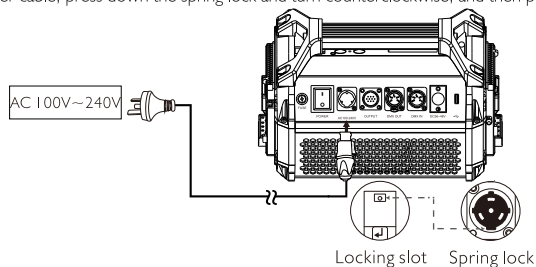

NOTE: Remove batteries when using external AC power. Leaving batteries installed may cause damage to the control box or batteries. ALWAYS remove batteries when the light is not in use for extended periods of time.

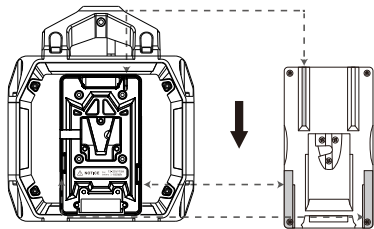

Lishuai laboratory uses the Rolux Battery for testing the product working time:

Battery and run time	660D	660B
RL-230S (14.8V 230Wh)	65 mins (60% of the total product power)	90 mins (60% of the total product power)
RL-190S (14.8V 190Wh)	55 mins (60% of the total product power)	75 mins (60% of the total product power)
BJ2250 (26V 260Wh)	45 mins (100% of the total product power)	60 mins (100% of the total product power)

Operating instructions:

1. Press the power button to power the light ON or OFF.

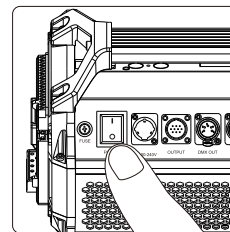

2. Control via power control box

(1) Menu buttons introductions

660D menu buttons : INT(Brightness) button, FX button, Fan button, Addr. (Address) setting button, Lang.(language) button and Multi-function interface dial/button.  
 660B menu buttons: Color temperature button, FX button, Fan button, Address setting button, Language button and Multi-function interface dial/button.

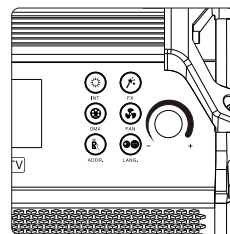

(660D)

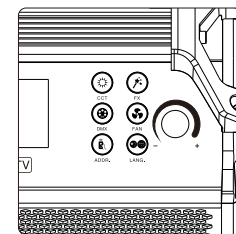

(660B)



(2)Intensity (Brightness) and Color temperature button operation  
 660D: Press the intensity button, then turn the multi-function interface dial to increase or decrease the brightness of the light. Brightness is adjustable from 0-100%.  
 660B: Press the Color temperature button, then press the multi-function interface button to switch between the brightness and color temperature, turn the multi-function interface dial to adjust the brightness between 0-100%, and the color temperature between 2700K-6500K.

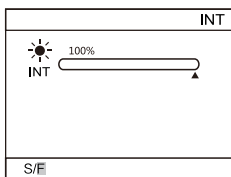

(660D)

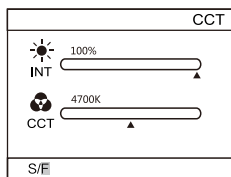

(660B)

(3)FX button ( Special effect button)  
 660D: Press the FX button, then press the multi-function interface button to switch between INT(brightness), mode and speed. Turn the multi-functional interface dial to control the brightness 0-100% , special effect and speed. The special effect mode includes lightning, fireworks,flash, breath, cop car, SOS, fault bulb, turn signal, tracing, screen, H&L beam.

660B: Press the FX button, then press the multi-function interface button to switch between brightness, color temperature, mode and speed 0-100%. Turn the multi-functional interface dial to control the brightness 0-100% , color temperature 2700K-6500K, special effect and speed 0-100%. The special effect mode includes lightning, fireworks,flash, breath, cop car, SOS, fault bulb, turn signal, tracing, screen, H&L beam.

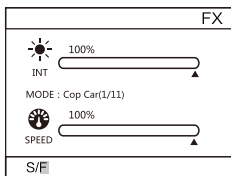

(660D)

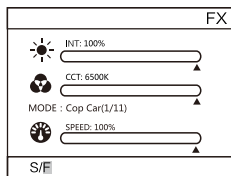

(660B)

(4)DMX button  
 Press the DMX button, turn the multi-function interface dial to change the address of the fixture. DMX address range is 1-512.

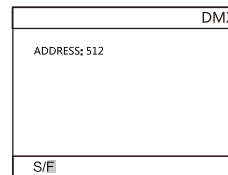

(5)Fan button  
 Press the fan button, turn the multi-function interface dial to change the speed of the fan between low, medium, high and auto.

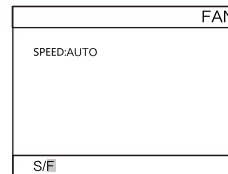

(6)Addr.( Address) setting button  
 Press the addr. setting button, turn the multi-function interface dial to change APP/remote address between 1-12.  
 Noted:RMT-OFF means that the remote control function can not be used.

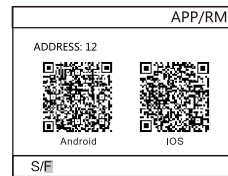



(7)Language button

Press language button, turn the multi-function interface dial to switch system language between English and Chinese.



(8)Fast and slow adjustments

Press the multi-function interface button for 5 seconds or longer to switch between fast and slow adjustments. The indicator at the bottom of the LCD will change between fast and slow to indicate which adjustment mode is active.

3.How to use CAME-TV Tioga APP

You can search CAME-TV Tioga in APP store or Android market or scan the QR code below to download the APP to control lights.



Android



IOS

Open the APP, Select DAYLIGHT or BI COLOR to search for devices, click to search device and enter the control interface.

Set APP address the same as on the light. The APP address can be set 1-12. Now the light can be controlled by the mobile APP. The Brightness,color temperature, special effects, language and APP address can be adjusted.

4.DMX connection

When using DMX function, connect the DMX cable to the DMX console (see the figure below). Set the DMX address to desired address for control on the DMX console.

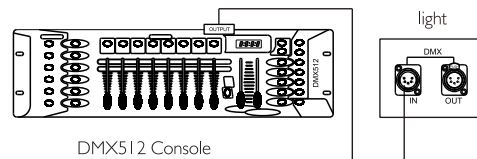

DMX512 Console

DMX connection for single light

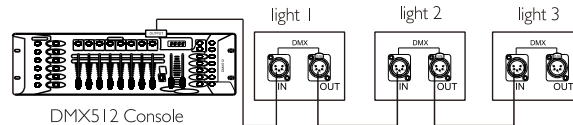

DMX512 Console

DMX connection for multiple lights

5. DMX control:

Please see below details of DMX address on LCD and corresponding channels on DMX console.

LCD display address	DMX console channels (single color temperature)	DMX console channels (Bi-color temperature)
1	1-1(Brightness)	1-1(brightness),1-2(color temperature)
2	1-2(Brightness)	1-2(brightness),1-3(color temperature)
.....	.....	.....
16	1-16(Brightness)	1-16(brightness),2-1(color temperature)
17	2-1(Brightness)	2-1(brightness),2-2(color temperature)
.....	.....	.....
511	32-15(Brightness)	32-15(brightness),32-16(color temperature)
512	32-16(Brightness)	



V.Product specifications

Spec	Model	660D	660B
LED		600W COB	400W daylight+400W tungsten
Beam angle		120°	
CRI		≥96	≥95
Color temperature		5600K(±300K)	2700K(±200K)-6500K(±300K)
TLCI		≥96	≥97
Power input		660W	500W max
Working voltage		AC100-240V,DC36-48V	
Cooling system		Heat pipe radiator , Temperature controlled fan	
Dimension (light body)		10.4 x 12.1 x1 6.8" (263x307x426MM)	
Dimension (power control box)		12.8x 7.3 x8.3" (325x1 85x2 12MM)	
Weight		Light body: 12.1 lb (5.49kg), Power control box: 11 lb (5kg)	Light body: 12.1 lb (5.49kg), Power control box: 8.5 lb (3.85kg)
Included accessories		Standard reflector, Protective cover, Power cable, DMX cable, Connecting cable, Safety cable, Custom carrying case	

660D illuminance:

Distance	Light without reflector	Light with standard reflector
1M	21300LUX	298800LUX
3M	2998LUX	16967LUX
5M	1252LUX	5698LUX
8M	548 LUX	2396LUX

660B illuminance without reflector :

Distance	Color temperature				
	2700K	3200K	4400K	5600K	6500K
2m	2923Lux	3490Lux	4105Lux	4215Lux	3914Lux
3m	1334Lux	1608Lux	1897Lux	1943Lux	1811Lux
5m	510Lux	615Lux	723Lux	742Lux	692Lux
7m	263Lux	318Lux	374Lux	384Lux	358Lux
9m	170Lux	205Lux	241Lux	247Lux	231Lux

660B illuminance with standard reflector 15° :

Distance	Color temperature				
	2700K	3200K	4400K	5600K	6500K
2m	21371Lux	26324Lux	31766Lux	31762Lux	29783Lux
3m	8313Lux	10357Lux	12320Lux	12269Lux	11598Lux
5m	2716Lux	3407Lux	4022Lux	4017Lux	3766Lux
7m	1354Lux	1691Lux	1995Lux	2019Lux	1884Lux
9m	836Lux	1042Lux	1222Lux	1240Lux	1160Lux

\*The specifications and parameters of this product are tested according to the laboratory samples of our company. There may be a little difference in the finished products, which will not affect the normal use;The design and specifications are subject to change without notice.