



## testo 324 - Leakage rates measuring instrument

Instruction manual



---

# 1 Contents

|          |  |           |
|----------|--|-----------|
| <b>1</b> | <b>Contents</b> .....  | <b>3</b>  |
| <b>2</b> | <b>Safety and the environment</b> .....  | <b>6</b>  |
|          | 2.1. About this document.....  | 6         |
|          | 2.2. Ensure safety.....  | 7         |
|          | 2.3. Protecting the environment.....   | 9         |
| <b>3</b> | <b>Specifications</b> .....  | <b>10</b> |
|          | 3.1. Use .....   | 10        |
|          | 3.2. Physical principles .....   | 11        |
|          | 3.2.1. Physical influence of temperature on the pressure to be measured .....                        | 11        |
|          | 3.2.2. The standardised measurement result of the testo 324 relating to temperature influences ..... | 11        |
|          | 3.3. Technical data .....  | 12        |
|          | 3.3.1. Examinations.....   | 12        |
|          | 3.3.2. Bluetooth® module (option).....   | 12        |
|          | 3.4. Approvals .....   | 12        |
|          | 3.4.1. Declaration of conformity .....   | 15        |
|          | 3.4.2. Measuring ranges and accuracies.....  | 15        |
|          | 3.4.3. Other instrument data .....   | 16        |
| <b>4</b> | <b>Product description</b> .....   | <b>18</b> |
|          | 4.1. Measuring instrument .....  | 18        |
|          | 4.1.1. Overview .....  | 18        |
|          | 4.1.2. Keypad .....  | 19        |
|          | 4.1.3. Display.....  | 20        |
|          | 4.1.4. Instrument connections.....   | 21        |
|          | 4.1.5. Interfaces .....  | 21        |
|          | 4.2. testo 324 in the case system with feeding unit .....  | 22        |
| <b>5</b> | <b>First steps</b> .....   | <b>23</b> |
|          | 5.1. Commissioning.....  | 23        |
|          | 5.2. Getting to know the product.....  | 23        |
|          | 5.2.1. Mains unit, rechargeable batteries.....   | 23        |
|          | 5.2.1.1. Charging the battery.....   | 23        |
|          | 5.2.1.2. Rechargeable battery care .....   | 24        |
|          | 5.2.1.3. Mains operation .....   | 24        |
|          | 5.2.2. Connecting hoses/probes .....   | 24        |
|          | 5.2.3. Switching on.....   | 24        |
|          | 5.2.4. Calling up the function .....   | 25        |
|          | 5.2.5. Entering values .....   | 25        |
|          | 5.2.6. Printing/saving data .....  | 26        |
|          | 5.2.7. Confirming an error message .....   | 27        |
|          | 5.2.8. Switching off.....  | 27        |

|           |  |           |
|-----------|--|-----------|
| 5.3.      | Address/location .....                                 | 27        |
| 5.4.      | Measurement records .....                              | 30        |
| 5.5.      | Instrument diagnosis .....                             | 30        |
| <b>6</b>  | <b>Using the product .....</b>                         | <b>32</b> |
| 6.1.      | Performing settings .....                              | 32        |
| 6.1.1.    | Assigning the right function key .....                 | 32        |
| 6.1.2.    | Instrument settings .....                              | 32        |
| 6.1.2.1.  | Units .....  | 32        |
| 6.1.2.2.  | Date/Time .....  | 33        |
| 6.1.2.3.  | Energy management .....                                | 33        |
| 6.1.2.4.  | Display brightness .....                               | 33        |
| 6.1.2.5.  | Printer .....  | 33        |
| 6.1.2.6.  | Bluetooth® .....                                       | 34        |
| 6.1.2.7.  | Automatic measuring rate .....                         | 34        |
| 6.1.2.8.  | Inspector .....  | 35        |
| 6.1.2.9.  | Language .....   | 35        |
| 6.1.2.10. | Country version .....                                  | 36        |
| 6.1.2.11. | Password protection .....                              | 36        |
| 6.1.3.    | Gas type .....   | 37        |
| 6.2.      | Measuring .....  | 38        |
| 6.2.1.    | Preparing for measurement .....                        | 38        |
| 6.2.2.    | Options menu .....                                     | 39        |
| 6.2.3.    | Pipe volume .....                                      | 39        |
| 6.2.4.    | Gas pipe (TRGI 2018) .....                             | 40        |
| 6.2.4.1.  | Pretest .....  | 42        |
| 6.2.4.2.  | Main test .....  | 43        |
| 6.2.4.3.  | Leakage test (leakage measurement) .....               | 45        |
| 6.2.4.4.  | Combined pretest/main test .....                       | 47        |
| 6.2.4.5.  | Caravan Check .....                                    | 49        |
| 6.2.5.    | Liquid gas (DVGW TRF 2012) .....                       | 50        |
| 6.2.5.1.  | Pressure test .....                                    | 51        |
| 6.2.5.2.  | Main test .....  | 52        |
| 6.2.5.3.  | Repeated testing (PS>0.5 bar / PS<=0.5 bar) .....      | 54        |
| 6.2.5.4.  | Carrying out repeated testing PS <0.5 bar .....        | 55        |
| 6.2.6.    | Drinking water (ZVSHK sheet as per DIN EN 806-4) ..... | 56        |
| 6.2.6.1.  | Testing with air – main test .....                     | 57        |
| 6.2.6.2.  | Testing with air – pretest .....                       | 58        |
| 6.2.6.3.  | Test with water .....                                  | 60        |
| 6.2.7.    | Waste water (DIN EN 1610) with air .....               | 62        |
| 6.2.8.    | Programs .....   | 63        |
| 6.2.8.1.  | Spot measurement .....                                 | 63        |
| 6.2.8.2.  | Programs 2-5 .....                                     | 64        |
| 6.2.9.    | Controller test .....                                  | 68        |
| 6.2.9.1.  | Static pressure .....                                  | 69        |
| 6.2.9.2.  | Flow pressure .....                                    | 70        |
| 6.2.9.3.  | SAV_triggering pressure .....                          | 70        |
| 6.2.9.4.  | SRV_triggering pressure .....                          | 71        |

---

|          |  |           |
|----------|--|-----------|
| 6.3.     | Transferring data .....                    | 72        |
| 6.3.1.   | Record printer .....                       | 72        |
| 6.3.2.   | PC/pocket PC.....                          | 72        |
| 6.3.3.   | Data transfer to IrDA record printer ..... | 73        |
| <b>7</b> | <b>Maintaining the product.....</b>        | <b>74</b> |
| 7.1.     | Cleaning the measuring instrument.....     | 74        |
| 7.2.     | Regular calibration.....                   | 74        |
| 7.3.     | Replacing the gas bladder.....             | 74        |
| <b>8</b> | <b>Tips and assistance.....</b>            | <b>75</b> |
| 8.1.     | Questions and answers.....                 | 75        |
| 8.2.     | Accessories and spare parts .....          | 75        |
| 8.3.     | Updating the instrument software .....     | 76        |

## 2 Safety and the environment

### 2.1. About this document



This document describes the product testo 324 with the instrument setting **Country version | Germany**.

#### Use

- > Please read this documentation through carefully and familiarize yourself with the product before putting it to use. Pay particular attention to the safety instructions and warning advice in order to prevent injuries and damage to the products.
- > Keep this document to hand so that you can refer to it when necessary.
- > Hand this documentation on to any subsequent users of the product.

#### Warnings

Always pay attention to information that is marked by the following warnings with warning pictograms. Implement the specified precautionary measures.

| Representation   | Explanation   |
|--|---|
|  <b>WARNING</b> | Indicates potential serious injuries                            |
|  <b>CAUTION</b> | indicates potential minor injuries                              |
| <b>NOTICE</b>  | indicates circumstances that may lead to damage to the products |

**Symbols and writing standards**

| Representation   | Explanation  |
|------------------|--|
| <b>i</b>         | Note: Basic or further information.                |
| 1. ...<br>2. ... | Action: more steps, the sequence must be followed. |
| > ...            | Action: a step or an optional step.                |
| - ...            | Result of an action.                               |

**Symbols and writing standards**

| Display   | Explanation   |
|---|---|
|  | Warning advice, risk level according to the signal word:<br><b>Warning!</b> Serious physical injury may occur.<br><b>Caution!</b> Minor physical injury or damage to the equipment may occur.<br>> Take the specified precautionary measures. |
| <b>i</b>  | Note: Basic or further information.   |
| 1. ...<br>2. ...  | Handling: several steps, the sequence must be followed.   |
| > ...   | Handling: one step or optional step.  |
| - ...   | Result of an action.  |
| <b>Menu</b>   | Elements of the instrument, the instrument display or the program interface.  |
| <b>[OK]</b>   | Control keys of the instrument or buttons of the program interface.   |
| ...   ...   | Functions/paths within a menu.  |
| "..."   | Example entries   |

## 2.2. Ensure safety

- > Only operate the product properly, for its intended purpose and within the parameters specified in the technical data. Do not use any force.
- > Do not operate the instrument if there are signs of damage at the housing, mains unit or feed lines.

- > Do not perform contact measurements on non-insulated, live parts.
- > Do not store the product together with solvents. Do not use any desiccants.
- > Carry out only the maintenance and repair work on this instrument that is described in the documentation. Follow the prescribed steps exactly. Use only original spare parts from Testo.
- > Any further or additional work must only be carried out by authorised personnel. Testo will otherwise refuse to accept responsibility for the proper functioning of the measuring instrument after repair and for the validity of certifications.
- > Only use the device in closed, dry rooms and protect it from rain and moisture.
- > Temperatures given on probes/sensors relate only to the measuring range of the sensors. Do not expose handles and feed lines to any temperatures in excess of 70 °C unless they are expressly permitted for higher temperatures.
- > The gas feeding unit should only be emptied in an open environment.
- > Do not operate the instrument if there are signs of damage at the housing, mains unit or feed lines.
- > Dangers may also arise from the systems being measured or the measuring environment: Note the safety regulations valid in your area when performing the measurements.
- > The mains unit must always be accessible while the instrument is charging so that the connection to the mains can be disconnected quickly in an emergency.

### **For products with Bluetooth® (optional)**

Changes or modifications that have been made without the explicit consent of the responsible approval authority, may cause the retraction of the type approval.

Data transfer may be disturbed by equipment that uses the same ISM-band, e.g. WLAN, microwave ovens, ZigBee.

The use of radio communication links is not permitted, among others, in aeroplanes and hospitals. For this reason the following points must be ensured before entering:

- > Switch off the device:
- > Isolate the device from any external power sources (mains cable, external rechargeable batteries, ...).



## **2.3. Protecting the environment**

- > Dispose of faulty rechargeable batteries/spent batteries in accordance with the valid legal specifications.
- > At the end of its useful life, send the product to the separate collection for electric and electronic devices (observe local regulations) or return the product to Testo for disposal.

## 3 Specifications

### 3.1. Use

#### testo 324

The testo 324 is a leakage measuring instrument for the professional performance of the following measuring tasks:

- Pretest and main test on gas pipes
- Determining the usability of gas pipes
- Measuring low pressure against atmospheric pressure
- Pressure test on waste water pipes
- Pressure tests on liquid gas pipes
- Controller test

|   |
|---|
|  <b>WARNING</b>  |
| <b>Escaping gas can produce an explosive mixture of gases!<br/>Potential risk of explosion!</b>   |
| > The testo 324 leakage measuring instrument may only be used by authorised personnel who have been trained in the maintenance and inspection of gas systems. |
| > Observe local accident prevention and test regulations.   |

---

**i** Testo guarantees the functionality of its products when used in accordance with their intended purpose. This guarantee does not apply to features of Testo products in combination with unauthorised third-party products. Competitor products are not authorised by Testo. As is common practice, Testo generally excludes support, warranty or guarantee claims relating to functionality that has not been guaranteed by Testo as part of the product offered. Claims shall also be excluded in the event of improper use or handling of the products, e.g. in combination with unauthorised third-party products. Further warranty terms: see website [www.testo.com/warranty](http://www.testo.com/warranty).

---

#### Feeding unit

When used in conjunction with the testo 324 leakage measuring instrument, the feeding unit (gas bladder) enables leakage measurement to be carried out independently of the gas supply.

## 3.2. Physical principles

### 3.2.1. Physical influence of temperature on the pressure to be measured

Temperature fluctuations and positional changes have an effect on the measuring accuracy of pressure measurements. The following should therefore be observed:

- ✓ The entire measurement system must be adapted to the ambient temperature and to the temperature of the line system to be tested.
- ✓ The temperature of the measurement system and the line system must remain stable during measurement.

Example of temperature influence:

with a test pressure of 100 hPa and an air pressure of 1000 hPa, the ambient temperature changes from +22 °C to +23 °C. The air in the test system expands and the test pressure increases by 3.73 hPa. The temperature influence on the pressure change is unaffected by the test volume.

### 3.2.2. The standardised measurement result of the testo 324 relating to temperature influences

The testo 324 leak rate measuring instrument certified to DVGW G 5952 enables measuring values to be reproduced. Comparable results based on the standardised reference operating pressure of 23 mbar are always achieved. The volume measured during the test is based on a reference temperature of 20 °C and the current air pressure.

A change in the ambient temperature therefore has no influence on the measuring values!

The ambient temperature and the relevant test gas or medium for each test section must nevertheless show a constant temperature within the range of 15 °C to 25 °C with a maximum deviation of  $\pm 2$  °C. Only then can a measurement be carried out. During the stability time at the start of each measurement, this check is carried out automatically and a warning is issued if the temperature and therefore the pressure fluctuates too greatly.

### 3.3. Technical data



#### 3.3.1. Examinations

Tested in accordance with DVGW<sup>1</sup> G5952 by DVGW Karlsruhe.  
As declared in the Certificate of Conformity, this product complies with Directive 2014/30/EU.

#### 3.3.2. Bluetooth® module (option)

The use of the wireless module is subject to the regulations and stipulations of the respective country of use, and the module may only be used in countries for which a country certification has been granted. The user and every owner has the obligation to adhere to these regulations and prerequisites for use, and acknowledges that the re-sale, export, import etc. in particular in countries without wireless permits, is his responsibility.

### 3.4. Approvals

| Product       | Testo 324   |
|---------------|---|
| Mat.-No.      | 0632 3240   |
| Country       | Comments  |
| Canada        | contains IC 5123A-WT11U<br>IC Warnings  |
| Europa + EFTA | <br><b>EU countries:</b><br>Belgium (BE), Bulgaria (BG), Denmark (DK), Germany (DE), Estonia (EE), Finland (FI), France (FR), Greece (GR), Ireland (IE), Italy (IT), Latvia (LV), Lithuania (LT), Luxembourg (LU), Malta (MT), Netherlands (NL), Austria (AT), Poland (PL), Portugal (PT), Romania (RO), Sweden (SE), Slovakia (SK), Slovenia (SI), Spain (ES), Czech Republic (CZ), Hungary (HU), United Kingdom (GB), Republic of Cyprus (CY). |
| Japan         |   <b>209- J00232</b>  |

---

<sup>1</sup> German Technical and Scientific Association for Gas and Water

| Turkey                | Authorized   |         |        |                 |                    |                |                                     |                     |       |                |         |                       |         |                   |                           |         |                 |                      |        |
|-----------------------|--|---------|--------|-----------------|--------------------|----------------|-------------------------------------|---------------------|-------|----------------|---------|-----------------------|---------|-------------------|---------------------------|---------|-----------------|----------------------|--------|
| USA                   | <br>contains FCC ID: QOQWT11U<br>FCC Warnings   |         |        |                 |                    |                |                                     |                     |       |                |         |                       |         |                   |                           |         |                 |                      |        |
| Radio module          | <table border="1"> <thead> <tr> <th>Feature</th> <th>Values</th> </tr> </thead> <tbody> <tr> <td>Bluetooth Range</td> <td>&lt;10 m (free field)</td> </tr> <tr> <td>Bluetooth type</td> <td>Bluegiga WTT11u<br/>Bluetooth Module</td> </tr> <tr> <td>Qualified Design ID</td> <td>22298</td> </tr> <tr> <td>Declaration ID</td> <td>B016141</td> </tr> <tr> <td>Bluetooth radio class</td> <td>Class 1</td> </tr> <tr> <td>Bluetooth company</td> <td>Silicon Laboratories Inc.</td> </tr> <tr> <td>RF Band</td> <td>2402 - 2480 MHz</td> </tr> <tr> <td>Nominal output power</td> <td>17 dBm</td> </tr> </tbody> </table> | Feature | Values | Bluetooth Range | <10 m (free field) | Bluetooth type | Bluegiga WTT11u<br>Bluetooth Module | Qualified Design ID | 22298 | Declaration ID | B016141 | Bluetooth radio class | Class 1 | Bluetooth company | Silicon Laboratories Inc. | RF Band | 2402 - 2480 MHz | Nominal output power | 17 dBm |
| Feature               | Values   |         |        |                 |                    |                |                                     |                     |       |                |         |                       |         |                   |                           |         |                 |                      |        |
| Bluetooth Range       | <10 m (free field)   |         |        |                 |                    |                |                                     |                     |       |                |         |                       |         |                   |                           |         |                 |                      |        |
| Bluetooth type        | Bluegiga WTT11u<br>Bluetooth Module  |         |        |                 |                    |                |                                     |                     |       |                |         |                       |         |                   |                           |         |                 |                      |        |
| Qualified Design ID   | 22298  |         |        |                 |                    |                |                                     |                     |       |                |         |                       |         |                   |                           |         |                 |                      |        |
| Declaration ID        | B016141  |         |        |                 |                    |                |                                     |                     |       |                |         |                       |         |                   |                           |         |                 |                      |        |
| Bluetooth radio class | Class 1  |         |        |                 |                    |                |                                     |                     |       |                |         |                       |         |                   |                           |         |                 |                      |        |
| Bluetooth company     | Silicon Laboratories Inc.  |         |        |                 |                    |                |                                     |                     |       |                |         |                       |         |                   |                           |         |                 |                      |        |
| RF Band               | 2402 - 2480 MHz  |         |        |                 |                    |                |                                     |                     |       |                |         |                       |         |                   |                           |         |                 |                      |        |
| Nominal output power  | 17 dBm   |         |        |                 |                    |                |                                     |                     |       |                |         |                       |         |                   |                           |         |                 |                      |        |

### IC Warnings

#### RSS-Gen & RSS-247 statement:

This device complies with Industry Canada licence-exempt RSS standard(s).

Operation is subject to the following two conditions:

- (1) this device may not cause interference, and
- (2) this device must accept any interference, including interference that may cause undesired operation of the device.

Le présent appareil est conforme aux CNR d'Industrie Canada applicables aux appareils radio exempts de licence.

L'exploitation est autorisée aux deux conditions suivantes :

- (1) l'appareil ne doit pas produire de brouillage, et
- (2) l'utilisateur de l'appareil doit accepter tout brouillage radioélectrique subi, même si le brouillage est susceptible d'en compromettre le fonctionnement.

Caution: Radio Frequency Radiation Exposure

This equipment complies with IC radiation exposure limits set forth for an uncontrolled environment and meets the IC radio frequency (RF) Exposure Guidelines. This

equipment should be installed and operated keeping the radiator at least 20 cm or more away from person's body in normal use position.

Co-Location:

This transmitter must not be co-located or operated in conjunction with any other antenna or transmitter.

Attention : exposition au rayonnement de radiofréquences

Cet équipement est conforme aux limites d'exposition aux radiofréquences IC fixées pour un environnement non contrôlé et aux Lignes directrices relatives à l'exposition aux radiofréquences (RF). Cet équipement devrait être installé et utilisé à une distance d'au moins 20 cm d'un radiateur ou à une distance plus grande du corps humain en position normale d'utilisation.

Co-location

Ce transmetteur ne peut pas être installé en colocation ou être utilisé avec une autre antenne ou transmetteur, quel qu'en soit le type.

### FCC Warnings

Information from the FCC (Federal Communications Commission)

#### **For your own safety**

Shielded cables should be used for a composite interface. This is to ensure continued protection against radio frequency interference.

#### **FCC warning statement**

This equipment has been tested and found to comply with the limits for a Class B digital device, pursuant to Part 15 of the FCC Rules. These limits are designed to provide reasonable protection against harmful interference in a residential installation. This equipment generates, uses and can radiate radio frequency energy and, if not installed and used in accordance with the instructions, may cause harmful interference to radio communications. However, there is no guarantee that interference will not occur in a particular installation. If this equipment does cause harmful interference to radio or television reception, which can be determined by turning the equipment off and on, the user is encouraged to try to correct the interference by one or more of the following measures:

- Reorient or relocate the receiving antenna.
- Increase the separation between the equipment and receiver.
- Connect the equipment into an outlet on a circuit different from that to which the receiver is connected.
- Consult the dealer or an experienced radio/TV technician for help.

#### **Caution**

Changes or modifications not expressly approved by the party responsible for compliance could void the user's authority to operate the equipment. Shielded interface cable must be used in order to comply with the emission limits.

#### **Warning**

This device complies with Part 15 of the FCC Rules. Operation is subject to the following two conditions:

- (1) this device may not cause harmful interference, and
- (2) this device must accept any interference received, including interference that may cause undesired operation.

#### **Caution: Radio Frequency Radiation Exposure**

This equipment complies with FCC radiation exposure limits set forth for an uncontrolled environment and meets the FCC radio frequency (RF) Exposure Guidelines. This equipment should be installed and operated keeping the radiator at least 20 cm or more away from person's body in normal use position.

## Japan Information

当該機器には電波法に基づく、技術基準適合証明等を受けた特定無線設備を装着している。

### 3.4.1. Declaration of conformity

You can find the EU declaration of conformity on the Testo homepage [www.testo.com](http://www.testo.com) under the product-specific downloads.

### 3.4.2. Measuring ranges and accuracies

| Measurement type   | Measuring range           | Accuracy  | Resolution |
|--|---------------------------|---|------------|
| Flow (Leakage measurement)                                       | 0 to 10 l/h               | $\pm 0.2$ l/h or $\pm 5\%$ of meas. val.  | 0.1 l/h    |
| Pressure   | 0...1000 hPa              | $\pm 0.5$ hPa or $\pm 3\%$ of meas. val.  | 0.1 mbar   |
| Pressure measurement with a high pressure probe (optional)       | 0...25 bar                | 0...10 bar:<br>$\pm 0.6\%$ of fullscale<br>>10...25 bar:<br>$\pm 0.6\%$ of fullscale          | 10 hPa     |
| Temperature measurement TC type K (only instrument) <sup>2</sup> | -40...600 °C              | $\pm 0,5^{\circ}\text{C}$<br>(0,0...100,0 °C)<br>$\pm 0,5\%$ of meas. val.<br>(rest of range) | 0,1°C      |
| Instrument overload  | Max. 1200 hPa             |   |            |
| Pipe volume calculation  | Max. 1200 l. <sup>3</sup> | +/-0,2l or 5% of meas. val. (1-200l)  |            |

<sup>2</sup> The accuracy of a connected temperature probe must also be taken into account.

<sup>3</sup> per 200 l: Test time 12 min

### 3.4.3. Other instrument data

#### Flue gas analyser

| Feature   | Values   |
|---|--|
| Storage/transportation conditions               | Temperature: -20 to 50°C   |
| Operating conditions                            | 5 to 40°C  |
| Power supply                                    | Rechargeable battery: Li-ion rechargeable battery 11.0 V / 2400 mAh<br>Mains unit:<br>Input 115-230 V - 50/60 Hz<br>Output 6.3 VDC |
| Power consumption                               | Mains unit: 12.6 W,<br>rechargeable battery: 5 W   |
| Protection class                                | IP0X   |
| Weight  | 1070 g (incl. battery)   |
| Dimensions                                      | 270 x 90 x 75 mm   |
| Additional probe sockets                        | 2 Hirschmann sockets for connecting pressure probes and temperature probes   |
| Gas connections                                 | 2 pressure connections DN 5  |
| Interference immunity and interference emission | According to DIN EN 61326-1  |
| Memory  | 500,000 measuring values   |
| Integrated pressure pump                        | For test pressure build-up up to 300 mbar and for filling the feeding unit   |
| Display   | Graphic colour display, 240 x 320 pixels   |
| Data transfer to PC                             | USB or Bluetooth (option)  |
| Battery charge time                             | Approx. 5-6 h  |
| Rech. batt. life                                | > 5 h (pump on, 20°C ambient temperature)  |
| Supported testo printer                         | 0554 0549, 0554 0547, 0554 0544 or 0554 0553, 0554 0620 (with Bluetooth option)  |
| Bluetooth® (option)                             | Range < 10 m   |



---

| <b>Feature</b>             | <b>Values</b>               |
|----------------------------|-----------------------------|
| Field of application       | Indoor use only             |
| Maximum operating altitude | 2000 m                      |
| Level of contamination     | PD2                         |
| Operating humidity         | 0 to 90 %RH, non-condensing |

## 4 Product description

### 4.1. Measuring instrument

#### 4.1.1. Overview



- 1 Switch on/off
- 2 Attachment eye for carrying strap
- 3 Interfaces (USB, infrared) and reset button









### CAUTION

#### **Risk of injury from infrared beam!**

- > Do not direct infrared beam at human eyes!

- 4 Display
- 5 Keypad
- 6 Instrument connections



## 4.1.2. Keypad

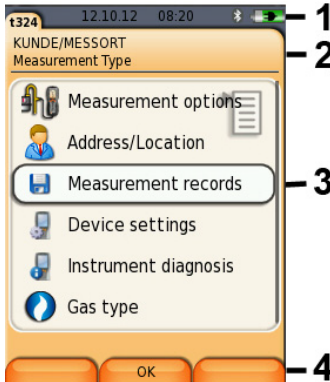

| Button   | Functions  |
|--|--|
|             | Switch measuring instrument on/off                                 |
| <br>Example | Function key (grey, 3x), relevant function is shown on the display |
|             | Scroll up, increase value  |
|             | Scroll down, reduce value  |
|             | Back, cancel function  |
|             | Open main menu   |
|             | Help texts, e.g. for individual measurements                       |
|            | Transmit data to the record printer.                               |

### 4.1.3. Display



1 Status bar (dark grey background):

- Warning symbol  (only if there is an instrument error, display of error in instrument diagnosis menu), otherwise: Instrument designation.
- Symbol 
- Display of date and time.
- Indication of Bluetooth® status, power supply and remaining rechargeable battery capacity:

| Symbol  | Feature   |
|---|---|
|    | Blue symbol = Bluetooth® on,<br>Grey symbol = Bluetooth® off  |
|   | Battery operation<br>Display of remaining rechargeable battery capacity by colour and fill level of the battery icon (green = 5 - 100%, red = < 5%) |
|  | Mains operation<br>Display of remaining rechargeable battery capacity: see above  |

- 2 Info field of register tabs: Display of selected address/location, selected measurement type.
- 3 Selection field for functions (selected menu item appears against a white background, unavailable functions are identified by grey font) or display of measuring values.
- 4 Function display for function keys.

#### 4.1.4. Instrument connections



- 1 Mains unit socket
- 2 Probe sockets for connecting the temperature probe or the high pressure probes
- 3 Pressure connection 1.2 bar for connecting a pressure hose
- 4 Pressure connection for connecting a feeding unit or a pressure hose

#### 4.1.5. Interfaces

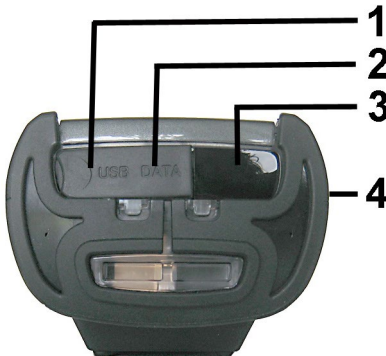

- 1 USB interface (under cover)
- 2 Reset button (under cover)
- 3 Infrared interface (IrDA)
- 4 Bluetooth interface (option)

## 4.2. testo 324 in the case system with feeding unit

### Overview

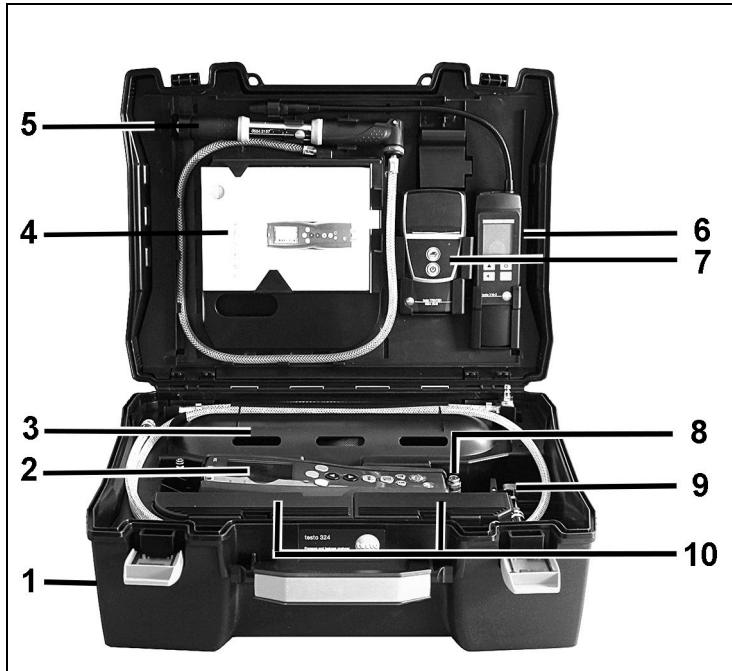

- 1 Transport case
- 2 testo 324
- 3 Feeding unit (gas bladder)
- 4 Storage compartment for instruction manual
- 5 Hand pump
- 6 Holder for gas leak detection instrument testo 316-2 or testo 316-EX
- 7 Holder for IRDA or Bluetooth printer (option)
- 8 Connection for an external hand pump or a compressor

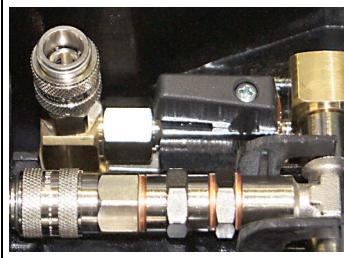

- 9 Connection block with shut-off valve for pump, instrument and hose connection
- 10 Storage compartments for accessories

## 5 First steps

### 5.1. Commissioning

#### testo 324

The testo 324 has a permanently installed rechargeable battery.

- > Charge the rechargeable battery fully before using the measuring instrument.
- > Remove the protective film from the display.

#### Feeding unit

Flushing is required when starting up the unit for the first time, after replacing the gas bladder and when changing the medium.

- > Fill and empty the feeding unit once, see Options menu

### 5.2. Getting to know the product

#### 5.2.1. Mains unit, rechargeable batteries

---

**i** In case of an extended interruption in the power supply to the testo 324 (e.g. rechargeable battery pack empty), the date/time settings will be lost.

---

##### 5.2.1.1. Charging the battery

The rechargeable battery can only be charged at an ambient temperature of 5 to +35 °C. If the rechargeable battery pack has discharged completely, the charging time at room temperature is approx. 5 - 6 h (charging with mains adapter).

### Charging via a mains unit

- ✓ The testo 324 is off.
- 1. Connect the mains unit instrument plug to the mains unit socket.
- 2. Connect the mains plug of the mains unit to a mains socket.
  - The charging process starts. The charge status is shown on the display.
  - Once the rechargeable battery has been charged, the instrument switches over automatically to trickle charge.

### 5.2.1.2. Rechargeable battery care

- > Do not fully exhaust rechargeable batteries.
- > For extended periods of disuse, you should discharge and recharge the batteries every 3 - 4 months. Trickle charging should not exceed 2 days.

### 5.2.1.3. Mains operation



In case of danger, the instrument must be disconnected from the power supply by simply pulling out the mains cable.

---

- > Always position the instrument so that the power supply plug can be easily reached.
- 1. Connect the mains unit instrument plug to the mains unit socket.
- 2. Connect the mains plug of the mains unit to a mains socket.
  - The power supply is provided by the mains unit.
  - If the testo 324 is switched off, the rechargeable battery charging process starts automatically. Switching on the testo 324 stops the battery charging and the instrument is then powered via the mains unit.

### 5.2.2. Connecting hoses/probes

- > Connect the required hoses/probes at the corresponding connections.

### 5.2.3. Switching on

- > Press .



When the instrument is switched on, the valves of the testo 324 are activated. Four short acoustic signals are output.

---



If fewer than 4 acoustic signals are sounded, the testo 324 must be switched on and off several times before use until 4 signals are sounded.

The testo 324 then starts up as usual.

- The start screen is displayed (duration: approx 15 s).
- If the voltage supply was interrupted for an extended period: The Date/Time menu is opened.
- The pressure sensors are zeroed.
- If there is an instrument error, the **Error diagnosis** menu is displayed.
- The **Measurement options** menu is displayed.

## 5.2.4. Calling up the function

1. Select function: **[▲]**, **[▼]**.
  - A box appears around the selected function.
2. Confirm selection: **[OK]**.
  - The selected function is opened.

## 5.2.5. Entering values

Some functions require values (numbers, units, characters) to be entered. Depending on the selected function, the values are entered either via a list field or an input editor.

### List field



1. Select the value to be changed (numerical value, unit): **[▲]**, **[▼]**, **[◀]**, **[▶]** (depending on the selected function).
2. Press **[Edit]** .
3. Set value: **[▲]**, **[▼]**, **[◀]**, **[▶]** (depending on the selected function).

4. Confirm the entry: **[OK]**.
5. Repeat steps 1 and 4 as required.
6. Save the entry: **[Finished]**.

### Input editor



1. Select the value (characters) to be changed: **[▲]**, **[▼]**, **[◀]**, **[▶]**.
2. Adopt the value: **[OK]**.  
Options:
  - > Toggle between upper/lower case:  
select **|← ABC→&\$/ →|** : **[▲]**, **[▼]** → **[ABC→&\$/]**.
  - > Position the cursor in the text:  
select **|← ABC→&\$/ →|** : **[▲]**, **[▼]** → **[|←]** or **[→|]**.
  - > Delete character before or after the cursor:  
select **Del Finished ←** : **[▲]**, **[▼]** → **[←]** or **[Del]**.
3. Repeat steps 1 and 2 as required.
4. Save the entry: select **Del Finished ←** : **[▲]**, **[▼]** → **[Finished]**.

## 5.2.6. Printing/saving data

Data is printed out via the key .

To be able to transfer data to a record printer via infrared or Bluetooth interface, the printer used must be enabled, see Printer, page 33

Data is saved via the **Options** menu. The **Options** menu is accessed via the left function key and is available in many different menus.

Once a measurement has been carried out, the measurement result can be saved via the right function key **Save**. Assignment of the right function key with the function **Save** or **Print**, see **Assigning the right function key**.

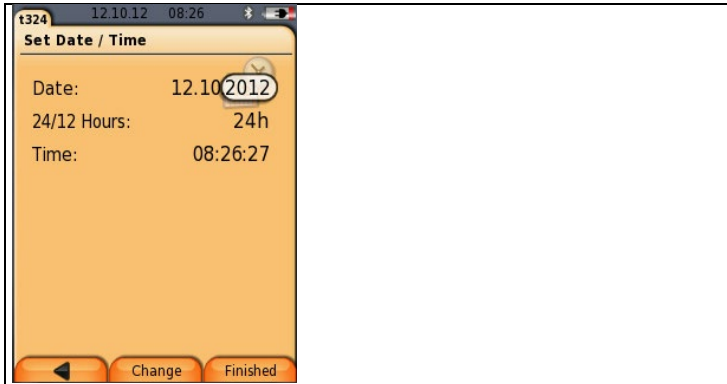

With other functions, saving is carried out automatically via the function key **Finished**, e.g. when creating **Address/Location** or entering **Date/Time**.

### 5.2.7. Confirming an error message

If an error occurs, an error message is shown on the display.

> Confirm error message: **[OK]**.

Errors that have occurred but have not yet been rectified are indicated by a warning symbol (⚠) in the header.

Error messages not yet resolved can be displayed in the menu **Error diagnosis**, see Instrument diagnosis.

### 5.2.8. Switching off



Unsaved measuring values are lost if the testo 324 is switched off.

> Press **[⏻]**.

- The measuring instrument switches off.

## 5.3. Address/location

All measuring values can be saved under the currently active location. Measuring values that have not been saved are lost when the measuring instrument is switched off!

Addresses and locations can be created, edited, copied and enabled. Addresses and locations (incl. records) can be deleted.

Call up function:

>  → **Address/Location** → **[OK]** .

There are various options for opening folders.

1. Edit search setting (**Search / Filter / Show all**): **[Edit]**
2. Select search setting: **[▲]**, **[▼]** → **[OK]**.

Possible settings:

- **Show all**: all addresses/locations are displayed
- **Search**: A search text only brings up addresses/locations that contain characteristics of the search text.
- **Filter**: Individual letters or numbers can be selected. All data beginning with the relevant letter/number is displayed.



The initial letter is the determining factor for the filter function, and this can only be selected individually. The search function can also be used to find a series of several letters within the folder name!

---

3. Carry out search according to search setting: **[Search]**

### Show all

1. Select address: **[▲]**, **[▼]**.
  2. Show details: **[Details]**.
  3. Enable location: select location → **[OK]**.
    - The location is enabled.
- > Open measurements menu: press **[OK]** again.

### Search

1. Edit search criterion: **[▶]** → **[Edit]**.
  2. Select search criteria: **[▲]**, **[▼]** → **[OK]**.

Possible options:

    - Contact person
    - Folder name
    - Town/city
    - Postcode
    - Street

- The selected criterion is displayed.
  3. Call up entry field for search text: **[▶]** or **[▼]**
- > Enter search text → **[Finished]**

**Filter**

1. Edit search criteria: **[Edit]**.
2. Select search criteria: **[▲], [▼] → [OK]**.  
Possible options:
  - Contact person
  - Folder name
  - Town/city
  - Postcode
  - Street
- The selected criterion is displayed.
3. Enable tab: **[▼]**
4. Select the required tab: **[▲], [▼]** and sometimes **[◀], [▶] → [Filter]**.  
- The search result for the relevant letter or number is displayed.

**Creating a new location:**

A measuring location is always created under an address.

1. Select the address under which the location should be created.
2. **[Options] → New location → [OK]**.
3. Enter values or make settings.
4. Finalise the entry: **[Finished]**.

**Other location options:**

- > **[Options] → Edit location:** make changes to an existing location.
- > **[Options] → Copy location:** make a copy of an existing location in the same folder.
- > **[Options] → Delete location:** delete an existing location.

**Creating new addresses:**

1. **[Options] → New address → [OK]**.
2. Enter values or make settings.
3. Finalise the entry: **[Finished]**.

**Additional address options:**

- **Edit address:** make changes to an existing folder.
- **Copy address:** make a copy of an existing address.
- **Delete address:** delete an existing address, including the locations created there.
- **Delete all addresses:** delete all existing addresses, including the locations created there.

## 5.4. Measurement records

Call up function:

>  → **Measurement records** → [OK].

There are various options for opening records, see Address/location, page 27.

**Displaying a record:**

1. Select the required record from the detailed view.
2. [Data].

**Options:**

- > [Options] → **Show Graphic**: display saved record data as graphic.
- > [Options] → **Delete Record**: delete the selected record.
- > [Options] → **Number of lines**: change the number of measuring values per display page.
- > [Options] → **Delete all records**: delete all saved records for a location.

## 5.5. Instrument diagnosis

Important operating values and instrument data are displayed. A main test can be carried out. Instrument errors that have not yet been rectified can be displayed.

Call up function:

>  → **Instrument diagnosis** → [OK].

**Error diagnosis**

- > **Error diagnosis** → [OK].
- Unresolved errors, warnings and notes are displayed.
  - > View next/previous error: [▲], [▼].

**Instrument information**

- > **Device Information** → [OK].
- Information is displayed.

**Tightness test**

1. **Main test** → **Tightness test** → [OK]
  2. Short both gas connections through the connection hose.
  3. Start the check: [OK].
- Zeroing of pressure sensor

- Pressure is built up and measurement is carried out
- The result of the measurement is indicated by a traffic light.

**Gas feeding unit test**

1. **Gas feeding unit test** → **[OK]**.
2. Connect the measuring instrument to the gas feeding unit.
3. Start the test: **[OK]**.
  - If the gas feeding unit is full, it is emptied.
4. Gas feeding unit is filled.
  - Settling period expires (15 min)
  - Measuring time expires (5 min)
  - The measurement result is indicated by a traffic light.
5. Gas feeding unit is emptied.
6. Exit testing: **[Back]**

## 6 Using the product

### 6.1. Performing settings

#### 6.1.1. Assigning the right function key

The right function key can have a function from the **Options** menu assigned to it. The menu **Options** is accessed via the left function key and is available in many different menus. This assignment is only valid for the currently opened menu / the opened function.

- ✓ A menu / function is opened in which the **Options** menu is displayed on the left function key.

1. Press **[Options]** .
2. Select option: **[▲]**, **[▼]**.

Depending on the menu / function from which the **Options** menu was opened, the following functions are available.

3. Assign the selected function to the right function key: Press **[Config. Key]**.

#### 6.1.2. Instrument settings



It is assumed that the contents of the chapter **First steps** (see **First steps**) are known.

Calling up a function:

> **[☰]** → **Device Settings**.

##### 6.1.2.1. Units

The units used for parameters in configuration menus can be set.

Call up function:

> **[☰]** → **Instrument settings** → **[OK]** → **Units** → **[OK]**.

##### Adjustable units

| Parameter            | Unit                                    |
|----------------------|---|
| <b>Pressure</b>      | <b>hPa, mbar, psi, inW, inHg</b>        |
| <b>Volume</b>        | <b>m<sup>3</sup>, l, ft<sup>3</sup></b> |
| <b>Ext. Pressure</b> | <b>bar, psi, kPa</b>                    |
| <b>Leakrate</b>      | <b>l/h, fl.oz, ml/min</b>               |



1. Select the line: [▲], [▼] → [Edit].
2. Select the unit to be changed: [▲], [▼] → [OK].
3. Confirm the entry: [Finished].

### 6.1.2.2. Date/Time

Date, time mode and time can be set.

Calling up the function:

- >  → Instrument settings → [OK] → Date/Time → [OK].

#### Set date/time:

1. Select parameter: [◀], [▲], [▼] → [Edit].
2. Set parameter: [▲], [▼] and sometimes [◀], [▶] → [OK].
3. Save settings: [Finished].

### 6.1.2.3. Energy management

Automatic instrument shutdown (Auto-Off) and switching off of the display light in battery operation can be set.

Calling up the function:

- >  → Instrument Settings → [OK] → Energy Management → [OK]

#### Making settings:

1. Select function or parameter: [▲], [▼] → [Edit].
2. Set parameter: [▲], [▼] and partly [◀], [▶] → [OK].
3. Save changes: [Finished].

### 6.1.2.4. Display brightness

The intensity of the display illumination can be set.

Calling up the function:

- >  → Instrument Settings → [OK] → Display Brightness → [OK]

Performing settings

- > Set parameter: [◀], [▶] → [OK].

### 6.1.2.5. Printer

The headers (lines 1-3) and the footer for the printout can be set.

The printer that is used can be enabled.

Call up function:

- >  → Instrument settings → [OK] → Printer → [OK].

### Enabling the printer:

---

**i** The 0554 0553 and 0554 0620 printers can only be selected if the Bluetooth® interface is enabled, see **Bluetooth®**, page 34.

---

**i** When using the testo IrDA record printer 0554 0547, the testo IrDA fast printer 0554 0549 must be selected.

---

**i** Graphics can be printed out using the following Testo printers:

0554 0547 IrDA report printer

0554 0549 IrDA report printer

0554 0553 Bluetooth® printer

0554 0620 Bluetooth® printer

---

1. **Select printer** → **[OK]**.
2. Select the printer: **[▲]**, **[▼]** → **[OK]**.
  - The printer is enabled and the **Printer** menu is opened.

### Setting the print text:

1. **Print text** → **[OK]**.
2. Select function: **[▲]**, **[▼]** → **[Edit]**.
3. Enter values → **[OK]**.
4. End input: **[Finished]**.
5. Save the entry: **[Finished]**.

### 6.1.2.6. Bluetooth®

This menu is only available if the instrument is equipped with Bluetooth. The Bluetooth module can be switched on / off. The relay can now be tested.

Calling up the function:

> **[☰]** → **Instrument Settings** → **[OK]** → **Bluetooth** → **[Edit]**.

### Making settings:

> Set parameter → **[OK]**.

### 6.1.2.7. Automatic measuring rate

The automatic measuring rate can be switched on or off.

If the automatic measuring rate is on, the following measuring rate is saved for the individual measurement programs (except **Programs** menu):

| Messzeit | Measuring rate |
|----------|----------------|
| < 15 min | 1 s            |
| > 15 min | 1 min          |

If the automatic measuring rate is switched off, a measuring rate of 1 second is used, irrespective of the measuring time.

Call up a function:

>  → **Instrument settings** → **[OK]** → **Autom. meas. rate** → **[OK]**.

#### Making settings:

1. **[Edit]**
2. Set parameter: **[▲]**, **[▼]** → **[OK]**.

### 6.1.2.8. Inspector

In this menu, an inspector can be selected and/or a new one can be created.

Calling up the function:

>  → **Instrument settings** → **[OK]** → **Inspector** → **[OK]**.

#### Making settings:

1. Edit/create inspector: **[▼]** → **[Edit]** → **[Finished]**.
2. Set parameter: **[▲]**, **[▼]** and sometimes **[◀]**, **[▶]** → **[OK]**.
3. Save changes: **[Finished]**.
4. **[Finished]**.

#### Selecting an inspector

> Select inspector: **[▲]**, **[▼]** → **[Enable]** → **[Finished]**.

### 6.1.2.9. Language

The menu language can be set. The number of available languages depends on the activated country version the function:

>  → **Instrument Settings** → **[OK]** → **Language** → **[OK]**

#### Activating the language:

> Select the language → **[OK]**.

### 6.1.2.10. Country version

The country version with national defaults (measurement types, standard values) can be set. The selection of the country version influences the menu languages that can be enabled.

Call up function:

>  → **Instrument settings** → **[OK]** → **Country version** → **[OK]**.



This setting can be password protected. A password is specified in the menu **Password Protection**, see Password protection.

---



Possibly:

> Enter password: **[Enter]** → Enter password → **[Finished]** → **[OK]**.

#### Setting the country version:

1. Select the country version: **[▲]**, **[▼]** → **[OK]**.
2. Confirm confirmation request: **Yes** → **[OK]**
- The system is restarted.

### 6.1.2.11. Password protection

The password protection is only valid for functions identified by the following symbol:  or .

Password protection can be enabled/disabled, the password can be changed.

To disable password protection, change the password to **0000** (factory setting).

Call up function:

>  → **Instrument settings** → **[OK]** → **password protection** → **[OK]**.

Possibly:

> Enter the current password:  
**[Enter]** → Enter password → **[Finished]** → **[OK]**.

#### Changing the password:

1. **[Edit]**.
2. Enter a new password → **[Finished]**.
3. **[Edit]**.
4. Enter the new password again to confirm → **[Finished]**.
5. Save changes: **[Finished]**.

### 6.1.3. Gas type

The gas type can be selected. The gas-specific coefficients and threshold values can be set.

**i** In order to maintain the measuring accuracy of the instrument, the correct gas must be selected or configured.

**i** Correct representation of measuring results is only assured if the threshold values for the ideal range of the corresponding measurement task have been set correctly. Preset threshold values are typical values for the selected gas type.

| Gas               | Standard designation                       | Gas composition                | Measuring range |
|-------------------|--|--------------------------------|-----------------|
| Natural gas (G20) | Complies with G20                          | Methane 100%                   | 0 to 10 l/h     |
| Natural gas (G25) | Complies with G25                          | Methane 86%<br>Nitrogen 14%    | 0 to 10 l/h     |
| Propane G31       | G31 burner test gas                        | Propane 100%                   | 0 to 5 l/h      |
| Propen G32        | G32 burner test gas                        | Propen 100%                    | 0 to 5.7 l/h    |
| G21               | G21 burner test gas<br>EN 437,<br>DIN 3362 | Methane 87%<br>Propane 13%     | 0 to 10 l/h     |
| G30               | G30 burner test gas                        | n-butane 50%<br>Iso-butane 50% | 0 to 3.2 l/h    |
| Air               | -  | Nitrogen 78%<br>Oxygen 21%     | 0 to 10 l/h     |
| CO2               | --   | CO2 100%                       | 0 to 9 l/h      |

Call up function:

>  → **Gas type** → **[OK]**.

**Enabling gas type:**

> Select the gas type → **[OK]**.

- The gas type is enabled and the main menu is opened.

**Setting coefficients:**

1. Select gas type → **[Coeff.]**.
2. Select the coefficients: **[Edit]**.

Possibly:

- > Enter password: **[Enter]** → Enter password → **[Finished]** → **[OK]**.
3. Set values → **[OK]**.
4. Save changes: **[Finished]**.

## 6.2. Measuring

### 6.2.1. Preparing for measurement

---

**i** The feeding unit (gas bladder) must be tested for leaks at regular intervals, see Instrument diagnosis, gas feeding unit test.

---

#### Caution

**Avoid damage to the instrument due to high pressure!**

> For tests with a test pressure of > 1 bar or using a liquid test medium e.g. water, a high pressure probe (art. no. 0638 1748) must be used.

---

**i** The **First steps** chapter (see First steps, page **23**) must have been read.

---

**i** General information on the tightness tests on gas and water pipes according to DVGW

- Before starting work on pipes carrying gas, the relevant shut-off device must be closed and secured against opening by unauthorised persons (e.g. when the key or the hand wheel is removed). Where gas escapes or could escape, it is necessary to ensure that the gas is disposed of safely through ventilation or routing it outdoors via a hose. The shut-off device should only be opened again when all openings of the pipes through which gas could escape have been tightly sealed. The above does not apply when dealing with external maintenance measures on pipes.
- If a leak is detected in accessible pipes carrying gas using a gas detector in accordance with DVGW advice G465-4 or with foaming agents in accordance with DIN EN 14291, the point must be sealed by means of suitable measures. Illumination with flames is not

---

---

permitted. Temporary sealing is only permissible in the short term to avoid immediate risks.

- Pipes with operating pressures up to 100 mbar are subject to a pretest and a main test, as well as a serviceability test (for system in operation). The tests should be carried out before the pipe is plastered over or covered and its connections are coated or encased. The tests can also be carried out in step-by-step.
  - All tests must be documented.
- 

**i** To protect the testo 324, it is necessary to ensure that the gases flowing into the pipes are free of oil, dust and moisture.

---

### Setting the location and gas type

Before carrying out measurements, the location and gas type must be correctly selected, see Address/location, page 27 and see Gas type, page 37.

## 6.2.2. Options menu

In the Measurement Type menu, for the various measurement types, under **[Options]**, the following selection is available:

- > **[Options]** → **Address/Location**: The Address/Location folder is opened.
  - > **[Options]** → **Gas type**: The Gas type folder is opened.
  - > **[Options]** → **Main test**: A main test can be carried out.
  - > **[Options]** → **Please empty gas feeding unit**: If a gas feeding unit is available, this is emptied automatically.
- 

**i** This option is only available in conjunction with a feeding unit.

---

- > **[Options]** → **Release air**: Air is released from the pipe into the environment.
  - > **[Options]** → **Release gas**: Gas is released from the pipe into the gas feeding unit.
- 

**i** This option is only available in conjunction with a feeding unit.

---

There are other options depending on the measurement type used.

## 6.2.3. Pipe volume

Based on the pipe volume calculation, unknown pipe volumes can be determined and allocated to the relevant measuring location. Particularly for the tightness test, where the stability time and

measurement time depends on the pipe volume, the advantage is even more accurate and more reliable measurement.

#### Calling up the function:

>  → **Measurements** → **[OK]** → **Pipe volume** → **[OK]**.

#### Setting parameters

| Parameter        | Selection                                 | Explanation                     |
|------------------|---|---------------------------------|
| Gas feeding unit | Yes/No                                    | Enable/disable gas feeding unit |
| Test gas         | Air, CO2, G30, G21, propane, natural gas, | Select test gas                 |

1. Select parameter → **[Edit]**.
2. Select or enter values: **[▲]**, **[▼]** and sometimes **[◀]**, **[▶]** → **[OK]**.

#### Carrying out the measurement:

3. Start measurement: **[▶]**.
  - > When **Gas feeding unit Yes** is selected: carry out steps in accordance with the information on the display and confirm with **[OK]**.
  - Zeroing starts (5 s)
  - Volume calculation is carried out (bar shows progress of the calculation)
  - Volume is displayed.
4. Adopt measurement result: **[Apply]**.

### 6.2.4. Gas pipe (TRGI 2018)

 **WARNING**

**Risk of explosion due to hazardous gas/air mixtures**

- > Do not feed air into pipes carrying gas.
- > Observe the information for the instrument if there is a risk that air is being routed into pipes carrying gas.



**CAUTION****Avoid damage to the instrument due to high pressure!**

> The test pressure of 1.2 bar must not be exceeded.

There are 5 different test types to choose from:

| <b>Test type</b>           | <b>Explanation</b>   |
|----------------------------|--|
| Pretest                    | The pretest (using air) is used for the load test (stability test) of newly laid gas pipes. The test is performed on the pipe without gas meter and fittings.  |
| Main test                  | The main test (using air or inert gas, e. g. CO <sub>2</sub> or N <sub>2</sub> ) is used for the tightness test (acceptance test) on newly laid or renovated pipes. The test is performed at the pipe, including the fittings, without gas installations and corresponding control and safety equipment.   |
| Leakage test               | This measurement is carried out to test the serviceability of an existing gas pipe system and is used to check the actual condition of the pipes. The pipe system may be in operation or disused. After handover of a gas system, the operator is responsible for proper operation, which is why it is recommended that the serviceability test is carried out every 12 years. |
| Combined pretest/main test | This measurement is carried out for newly laid pipe systems with operating pressures of 100 hPa to 0.1 MPa. The test includes pipe systems including fittings, but without gas pressure controllers, gas appliances, gas meters and relevant regulating and safety devices.  |

| Test type      | Explanation   |
|----------------|---|
| aCaravan check | Tightness test on gas pipes in accordance with the EN 1949 standard and DVGW G 607. Since 1 April 2006, a valid G 607 test is a requirement for the HU (general inspection) with the TÜV (German Technical Inspection Agency). Caravan and motorhome owners are obliged to have their liquid gas systems checked every 2 years. |

### 6.2.4.1. Pretest

This test is used as a load test for newly laid gas pipes and is carried out before the main test. The test is performed on the pipe without a gas meter and fittings. The pipe is subjected to many times the subsequent operating pressure, so the material is exposed to a significantly greater load than is expected during normal operation.

#### Calling up the function:

>  → **Measurements** → [OK] → **Gas pipe (TRGI 2018)** → **Pretest** → [OK].

#### Setting parameters

| Parameter              | Explanation  |
|------------------------|--|
| Stability time         | Set stability time   |
| Measurement period     | Adopt or set measurement period<br><br><b>i</b> According to DVGW TRGI 2018, the measurement period is 10 min. |
| Test pressure (target) | Adopt or set test pressure<br><br><b>i</b> According to DVGW TRGI 2018, the test pressure (target) is 0.1 MPa. |
| Pressure               | Set pressure   |

1. Edit values: [Edit].
2. Enter values. [▲], [▼] and sometimes [◀], [▶] → [OK].



### Carrying out a pretest

1. Build up test pressure (target) manually with the test pump or a compressor at the connection provided.
2. Close the shut-off valve.



---

**i** The valve must always be closed during measurements.  
Only open to apply pressure. Close it again

---

3. Start measurement: [].
  - Zeroing starts (5 s)
    - Option
      - > End stability time early: **[Next]**
      - > End measurement period early: **[Next]**
  - Pretest is ended.
4. Evaluate measurement result: [, ] → **[OK]**.
  - The measurement result is displayed
5. Save measurement result: **[Save]**.

### Options

- > **[Options]** → **Show Graphic**: a section of past measuring values is displayed in a line graph (zoom function available [, ]).
- > **[Options]** → **Manometer**: the measuring values are displayed in the same way.
- > **[Options]** → **Factory setting**: the values are reset to the default settings.
- > **[Options]** → **Overall graphic curve**: the measuring values across the overall measuring time are displayed in a line graph.

### 6.2.4.2. Main test

The main test (using air or inert gas such as CO<sub>2</sub> or N<sub>2</sub>) is a tightness test for pipes including fittings, but without gas appliances and the relevant regulating and safety devices. The main test is carried out after a successfully completed pretest on newly laid gas pipes or after renovation of existing gas pipes and is used for the acceptance of these pipes. It shows up even the smallest leaks in gas pipes.

### Calling up the function:

- > [] → **Measurements** → **[OK]** → **Gas pipe (TRGI 2018)** → **Main test** → **[OK]**.

### Setting parameters

- i** According to DVGW TRGI 2018, the stability time and measurement period depend on the pipe volume.
- Pipe volume < 100 l: Adjustment time 10 min, measurement period 10 min.
  - Pipe volume > 100 l - < 200 l: Adjustment time 30 min, measurement period 20 min.
  - Pipe volume > 200 l: Adjustment time 60 min, measurement period 30 min.

| Parameter              | Explanation  |
|------------------------|--|
| Volume                 | Set volume<br><br><b>i</b> The pipe volume can also be measured directly, see <b>[Options]</b> → <b>Volume</b> |
| Stability time         | Set stability time   |
| Measurement period     | Set measurement period   |
| Test pressure (target) | Set test pressure<br><br><b>i</b> According to DVGW TRGI 2018, the test pressure (target) is 150 hPa.          |

1. Edit values: **[Edit]**.
2. Enter values. **[▲]**, **[▼]** and sometimes **[◀]**, **[▶]** → **[OK]**.

### Carrying out a main test

1. Start measurement: **[▶]**.
  - Zeroing starts (5 s)
  - Test pressure (target) is built up automatically by the instrument Option
    - > End stability time early: **[Next]**
    - > End measurement period early: **[Next]**
  - Main test is ended.
2. Evaluate measurement result: **[▲]**, **[▼]** → **[OK]**.
  - The measurement result is displayed
3. Save measurement result: **[Save]**.

### Options

- > **[Options]** → **Show Graphic**: a section of past measuring values is displayed in a line graph (zoom function available [**▲**], [**▼**]).
- > **[Options]** → **Volume**: The pipe volume is determined directly (the option is no longer available after the measurement).
- > **[Options]** → **Manometer**: The measuring values are displayed in the same way.
- > **[Options]** → **Factory setting**: the values are reset to the default settings.
- > **[Options]** → **Overall graphic curve**: the measuring values across the overall measuring time are displayed in a line graph.

#### 6.2.4.3. Leakage test (leakage measurement)

This measurement is carried out to test the serviceability of an existing gas pipe system (in contrast to the pretest and main test) and is used to check the actual condition of the pipes. The pipe system may be in operation or disused

For the serviceability test, the testo 324 can be operated together with the feeding unit. The feeding unit supplies the test medium (gas or air).

The advantages of a measurement with the feeding unit:

- Pressure fluctuations that may occur in gas pipes and affect the measurement are compensated (test independent of the gas supply).
- No need to dismantle the gas meter/the instrument can be used at any point on the system.
- Safe measurements thanks to the feed-in of gas, as there is no risk caused by air in a pipe carrying gas.

Test pressure:

- Operating pressure <30 hPa = reference pressure (23 hPa)
- Operating pressure >30 hPa = operating pressure

---

**i** According to DVGW TRGI 2018, the stability time and measurement period depend on the pipe volume.

- Pipe volume < 100 l: Adjustment time 10 min, measurement period 5 min.
  - Pipe volume < 200 l: Adjustment time 30 min, measurement period 10 min.
  - Pipe volume < 300 l: Adjustment time 60 min, measurement period 15 min.
  - Pipe volume < 400 l: Adjustment time 120 min, measurement period 20 min.
-

- Pipe volume < 500 l: Adjustment time 240 min, measurement period 25 min.

**Calling up the function:**

1.  → **Measurements** → **[OK]** → **Gas pipe (TRGI 2018)** → **Leakage test** → **[OK]**.
2. Select **Feeding with gas** (feeding unit required), **Feeding with air**, **as gas meter replacement**: **[▲]**, **[▼]** → **[OK]**.

**Setting parameters**

| Parameter          | Explanation  |
|--------------------|--|
| Volume             | Set volume<br><br><b>i</b> The pipe volume can also be measured directly, see <b>[Options]</b> → <b>Volume</b> |
| Stability time     | Set stability time   |
| Measurement period | Set measurement period   |
| Pipe type          | Set pipe type  |

1. Edit values: **[Edit]**.
2. Enter values. **[▲]**, **[▼]** and sometimes **[◀]**, **[▶]** → **[OK]**.

**Carrying out a leakage test (leakage measurement)**

1. Start measurement: **[▶]**.
  - > When **Feeding with gas**, **Feeding with air** is selected: carry out steps in accordance with the information on the display and confirm with **[OK]**.
  - Zeroing starts (5 s)
  - Regulation Option
    - > End stability time early: **[Next]**
    - > End measurement period early: **[Next]**
    - Measurement is cancelled.
  - Leakage test (leakage measurement) is ended.
2. Evaluate measurement result: **[▲]**, **[▼]** → **[OK]**.
  - The measurement result is displayed
3. Save measurement result: **[Save]**.
  - The measurement result is displayed

## 4. Evaluate measurement result:

|                     |                         |
|---------------------|-------------------------|
| Leakage test result | Select result           |
| Visual check        | Select result           |
| System checked      | Enter system details    |
| Gas meter number    | Enter gas meter number  |
| Gas meter level     | Enter gas meter level   |
| Inspector           | Enter name of inspector |

5. Edit values: **[Edit]**.6. Enter values. **[▲]**, **[▼]** and sometimes **[◀]**, **[▶]** → **[OK]**.7. Save entries: **[Save]**.**Option**

- > **[Options]** → **Show Graphic**: a section of past measuring values is displayed in a line graph (zoom function available **[▲]**, **[▼]**).
- > **[Options]** → **Settings**: The type of test (reference pressure/operating pressure) can be set and the reference pressure of 23 mbar is displayed.
- > **[Options]** → **Volume**: the pipe volume is determined directly (the option is no longer available after the measurement).
- > **[Options]** → **Manometer**: the measuring values are displayed in the same way.
- > **[Options]** → **Factory setting**: the values are reset to the default settings.
- > **[Options]** → **Overall graphic curve**: the measuring values across the overall measuring time are displayed in a line graph.

**6.2.4.4. Combined pretest/main test**

The combined pretest/main test is carried out on newly laid pipe systems with operating pressures of 100 mbar to 1 bar.

The test includes pipe systems including fittings, but without gas pressure controllers, gas appliances, gas meters and relevant regulating and safety devices.



A high pressure probe is required for this test.

---

**Calling up the function:**

- > **[📄]** → **Measurement** → **[OK]** → **Gas pipe (TRGI 2018)** → **Combined Pre-/ Maintest** → **[OK]**.

### Setting parameters

| Parameter              | Explanation   |
|------------------------|---|
| Volume                 | Set volume<br><br> The pipe volume can also be measured directly, see <b>[Options]</b> → <b>Volume</b> |
| Stability time         | Set stability time  |
| Measurement period     | Set measurement period  |
| Test pressure (target) | Set test pressure   |

1. Edit values: **[Edit]**.
2. Enter values. **[▲]**, **[▼]** and sometimes **[◀]**, **[▶]** → **[OK]**.

### Carrying out a combined pretest/main test

1. Start measurement: **[▶]**.
  - Zeroing starts (5 s)
  - Build up test pressure (target) manually with the test pump or a compressor at the connection provided.
    - Option
      - > End stability time early: **[Next]**
      - > End measurement period early: **[Next]**
    - Measurement is cancelled.
  - Combined pretest/main test is ended.
2. Evaluate measurement result: **[▲]**, **[▼]** → **[OK]**.
  - The measurement result is displayed
3. Save measurement result: **[Save]**.

### Options

- > **[Options]** → **Show Graphic**: a section of past measuring values is displayed in a line graph (zoom function available **[▲]**, **[▼]**).
- > **[Options]** → **Manometer**: The measuring values are displayed in the same way.
- > **[Options]** → **Factory setting**: the values are reset to the default settings.
- > **[Options]** → **Overall graphic curve**: the measuring values across the overall measuring time are displayed in a line graph.



### 6.2.4.5. Caravan Check

The caravan check is a tightness test in accordance with DVGW G 607 and relates to vehicles with a permanently installed gas system. The whole gas installation is checked.

#### Call up function:

- >  → **Measurements** → **[OK]** → **Gas pipe (TRGI 2018)** → **Caravan Check** → **[OK]**.

#### Set parameters

| Parameters                      | Explanation  |
|---------------------------------|--|
| Stability time                  | Set stability time   |
| Measurement period (nominal)    | Set measurement period (nominal)   |
| Diff. pressure $\Delta p_{max}$ | Set maximum permissible differential pressure  |
| Pressure build-up               | Automatic<br>Pressure is built up automatically via the integrated pressure pump (up to max. 200 mbar, up to max. line volume 5 l) |
| Test pressure (nom.)            | Set test pressure  |
| Vehicle number                  | Enter vehicle number   |
| Inspector                       | Enter inspector's name   |

- Edit values: **[Edit]**.
- Enter values: **[▲]**, **[▼]** and sometimes **[◀]**, **[▶]** → **[OK]**.

#### Carry out caravan check

- Start measurement: **[▶]**.
  - Zeroing starts (5 s).
  - Test pressure (nom.) is built up automatically.

**i** If the test pressure (nom.) is not reached after 2 min. 30 sec., the pressure build-up is terminated and an information is displayed.  
Reasons for aborting the pressure build-up can be too much leakage in the gas line.

#### Option

- > End stability time early: **[Next]**.

- > End measurement period early: **[Next]**.

---

**i** If the test pressure drops by more than 10 % within the stabilization or measuring time, the measurement is interrupted and an information is displayed.

---

- Measurement is cancelled.
  - Caravan check ends.
2. Evaluate measurement result: **[▲], [▼] → [OK]**.
    - Measurement result is displayed.
  3. Save measurement result: **[Save]**.

### Options

- > **[Options] → Show Graphic**: An excerpt of past measuring values is displayed in a line graph (zoom function available **[▲], [▼]**).
- > **[Options] → Manometer**: The measuring values are shown in an analogue display.
- > **[Options] → Overall graphic curve**: The measuring values across the overall measuring time are displayed in a line graph.

## 6.2.5. Liquid gas (DVGW TRF 2012)

### CAUTION

#### Avoid damage to the instrument due to high pressure!

- > The test pressure of 1.2 bar must not be exceeded.

---

**i** Liquid gas pipes must be subjected to a pressure test and a main test before corrosion protection is applied, before plastering or any other covering work and before a liquid gas vessel is commissioned (filled). It must be certified that the pipelines have been properly constructed.

---

There are 3 different test types to choose from:

- Pressure test
  - During the pressure test, the liquid gas pipes are tested at a higher pressure than the normal operating pressure. This means that the material is exposed to a greater load. The pressure test detects weaknesses and shows up any material defects.
  - Installed pressure controllers and gas meters must be dismantled before the pressure test. The pressure test is carried out before commissioning.
  - Pressure testing of liquid gas pipelines must be carried out with air or nitrogen, taking equipment accessories into account. However, it can also be carried out using water as the test

medium. According to the TRF (Germany), the pressure during the pressure test must be 1.1 times the permissible pressure (determined by the SSV triggering pressure), but at least 1 bar. A pressure drop is not permissible after expiry of the stability time and measurement period.



- **Main test**  
The main test (using air or inert gas, e.g. CO<sub>2</sub> or N<sub>2</sub>) is carried out immediately before commissioning. It is used as a tightness test (acceptance test) on newly laid or renovated pipes. The test includes all pipelines up to the closed instrument connectors of the gas appliances.  
Immediately prior to commissioning and following the pressure test, all pipelines, going as far as the adjustment elements of the instrument, must be tested for tightness using air at an overpressure of 100 mbar (TRF, Germany).
- **Repeated testing PS >0.5 bar**  
Pipelines with PS >0.5 bar must be subjected to a pressure test every 10 years. Pipelines with DN > 25 must be subjected to a main test under operating conditions every 2 years.
- **Repeated testing PS ≤0.5 bar**  
Pipelines with PS ≤0.5 bar must be subjected to a main test every 10 years.

### 6.2.5.1. Pressure test

#### Calling up the function:

>  → **Measurements** → **[OK]** → **Liquid gas (TRF)** → **Pressure test** → **[OK]**.

#### Setting parameters

| Parameter          | Explanation   |
|--------------------|---|
| Stability time     | Set stability time  |
|                    |  TRF 2012 stipulates a stability time of 10 min.     |
| Measurement period | Set measurement period  |
|                    |  TRF 2012 stipulates a measurement period of 10 min. |

| Parameter              | Explanation   |
|------------------------|---|
| Test pressure (target) | Set test pressure   |
|                        |  TRF 2012 stipulates a test pressure of 1000 mbar. |

1. Edit values: **[Edit]**.
2. Enter values. **[▲]**, **[▼]** and sometimes **[◀]**, **[▶]** → **[OK]**.

### Carrying out a pressure test

1. Build up test pressure (target) manually with the test pump or a compressor at the connection provided.
2. Start measurement: **[▶]**.
  - Zeroing starts (5 s)
    - Option
    - > End stability time early: **[Next]**
    - > End measurement period early: **[Next]**
    - Measurement is cancelled.
  - Pressure test is ended.
3. Evaluate measurement result: **[▲]**, **[▼]** → **[OK]**.
  - The measurement result is displayed
4. Save measurement result: **[Save]**.

### Options

- > **[Options]** → **Show Graphic**: a section of past measuring values is displayed in a line graph (zoom function available **[▲]**, **[▼]**).
- > **[Options]** → **Manometer**: The measuring values are displayed in the same way.
- > **[Options]** → **Factory setting**: the values are reset to the default settings.
- > **[Options]** → **Overall graphic curve**: the measuring values across the overall measuring time are displayed in a line graph.



#### 6.2.5.2. Main test

Immediately prior to commissioning and following the pressure test, all pipelines, going as far as the closed instrument connectors of the gas appliances, must be tested for tightness using air at an overpressure of 150 mbar (TRF 2012). The pipelines are deemed leak-proof if, following temperature equalisation, the test pressure does not drop throughout the subsequent 10 minute duration of the test.

**Calling up the function:**

- >  → **Measurements** → **[OK]** → **Liquid gas (TRF)** → **Main test** → **[OK]**.

**Setting parameters**

| Parameter              | Explanation   |
|------------------------|---|
| Stability time         | Set stability time  |
| Measurement period     | Set measurement period  |
|                        |  TRF 2012 stipulates a measurement period of 10 min.   |
| Test pressure (target) | Set test pressure   |
|                        |  According to TRF 2012, the test pressure is 150 mbar. |

- Edit values: **[Edit]**.
- Enter values: **[▲]**, **[▼]** and sometimes **[◀]**, **[▶]** → **[OK]**.

**Carrying out a main test**

- Start measurement: **[▶]**.
  - The test pressure (target) is built up automatically by the instrument.
  - Zeroing starts (5 s)
    - Option
      - > End stability time early: **[Next]**
      - > End measurement period early: **[Next]**
      - Measurement is cancelled.
    - Pressure test is ended.
- Evaluate measurement result: **[▲]**, **[▼]** → **[OK]**.
  - The measurement result is displayed
- Save measurement result: **[Save]**.

**Options**

- > **[Options]** → **Show Graphic**: a section of past measuring values is displayed in a line graph (zoom function available **[▲]**, **[▼]**)
- > **[Options]** → **Manometer**: The measuring values are displayed in the same way.
- > **[Options]** → **Factory setting**: the values are reset to the default settings.

- > **[Options]** → **Overall graphic curve**: the measuring values across the overall measuring time are displayed in a line graph.

### 6.2.5.3. Repeated testing (PS>0.5 bar / PS<=0.5 bar)

The aim of this testing is to establish, at the time of testing, whether the pipe is in proper working condition for the intended application and can satisfy the requirements until the next test.

#### Calling up the function:

- > **[F5]** → **Measurements** → **[OK]** → **Liquid gas (TRF)** → **Repeated testing PS>0.5 bar** or **Repeated testing PS<=0.5 bar** → **[OK]**.

#### Setting parameters

| Parameter              | Explanation  |
|------------------------|--|
| Stability time         | Set stability time   |
| Measurement period     | Set measurement period   |
|                        | <b>i</b> TRF 2012 stipulates a measurement period of 10 min.   |
| Test pressure (target) | Set test pressure  |
|                        | <b>i</b> According to TRF 2012, the test pressure is 150 mbar. |

1. Edit values: **[Edit]**.
2. Enter values. **[▲]**, **[▼]** and sometimes **[◀]**, **[▶]** → **[OK]**.

#### Carrying out repeated testing PS>0.5 bar

1. Build up test pressure (target) manually with the test pump or a compressor at the connection provided.
2. Start measurement: **[▶]**.
  - Zeroing starts (5 s)
    - Option
      - > End stability time early: **[Next]**
      - > End measurement period early: **[Next]**
      - Measurement is cancelled.
    - Pressure test is ended.
3. Evaluate measurement result: **[▲]**, **[▼]** → **[OK]**.
  - The measurement result is displayed
4. Save the measurement result: **[Save]**.

### Options

- > **[Options]** → **Show Graphic**: a section of past measuring values is displayed in a line graph (zoom function available **[▲]**, **[▼]**).
- > **[Options]** → **Manometer**: The measuring values are displayed in the same way.
- > **[Options]** → **Factory setting**: the values are reset to the default settings.
- > **[Options]** → **Overall graphic curve**: the measuring values across the overall measuring time are displayed in a line graph.

#### 6.2.5.4. Carrying out repeated testing PS <0.5 bar

The aim of this testing is to establish, at the time of testing, whether the pipe is in proper working condition for the intended application and can satisfy the requirements until the next test.

#### Call up a function:

- > **[☰]** → **Measurement options** → **[OK]** → **Liquid gas (TRF)** → **Repeated testing PS < 0.5 bar**.

#### Setting parameters

| Parameter              | Explanation  |
|------------------------|--|
| Stability time         | Set stability time   |
| Measurement period     | Set measurement period<br><br><b>i</b> DVGW TRF 2012 and ÖVGW G2/2 specify a measurement period of 10 min. |
| Test pressure (target) | Set test pressure<br><br><b>i</b> DVGW TRF 2012 and ÖVGW G2/2 specify a test pressure of 150 mbar.         |

1. Edit values: **[Edit]**.
2. Enter values. **[▲]**, **[▼]** and sometimes **[◀]**, **[▶]** → **[OK]**.

#### Carrying out repeated testing (PS <0.5 bar)

1. Start measurement: **[▶]**.
  - The test pressure (target) is built up automatically by the instrument.
  - Zeroing starts (5 s).

- Option
  - > End stability time early: **[Next]**.
  - > End measurement period early: **[Next]**.
  - Measurement is cancelled.
- Pressure test is ended.
- 2. Evaluate measurement result: **[▲]**, **[▼]** → **[OK]**.
  - The measurement result is displayed.
- 3. Save measurement result: **[Save]**.

### Options

- > **[Options]** → **Show Graphic**: a section of past measuring values is displayed in a line graph (zoom function available **[▲]**, **[▼]**).
- > **[Options]** → **Manometer**: The measuring values are displayed in the same way.
- > **[Options]** → **Factory setting**: the values are reset to the default settings.
- > **[Options]** → **Overall graphic curve**: the measuring values across the overall measuring time are displayed in a line graph.

## 6.2.6. Drinking water (ZVSHK sheet as per DIN EN 806-4)

The drinking water pipes are tested for tightness before commissioning using air/inert gas or water. For reasons of hygiene, it is best if the pipes remain dry until shortly before commissioning and do not undergo a main test using water. It is also recommended that a pressure test be carried out with air as a preventive measure against corrosion in metallic materials.

There are 2 different test types to choose from:

- Testing with air
  - The main test should be carried out with air if:
    - Following the main test, there is prolonged downtime to eliminate the possibility of bacterial growth
    - Following the main test, the pipe system cannot remain completely filled (e.g. frost period)
    - The corrosion resistance of a material of a partially-filled pipe is compromised
    - In buildings with more stringent hygienic requirements (e.g. hospitals), it may be necessary to use inert gases to eliminate the risk of condensation of humidity in the pipeline.
- Testing with water
  - The main test should only be carried out with water if testing is taking place shortly before the commissioning of a drinking water system. According to the ZVSHK sheet as per DIN EN



806-4, there are three different test methods. These depend on various material properties.

The main test with water can only be carried out if:

- From the main test up until the drinking water installation is commissioned, the water is changed regularly (after 7 days at the latest).
- It is guaranteed that the house or construction site water connections are approved for connection and operation.
- The pipe system is filled hygienically.
- The system remains fully filled from the main test up until commissioning (no partial filling!).

### 6.2.6.1. Testing with air – main test

Calling up the function:

>  → **Measurements** → **[OK]** → **Drinking water** → **Test with air** → **Main test** → **[OK]**.

Setting parameters

| Parameter              | Explanation  |
|------------------------|--|
| Volume                 | Set volume<br><br><b>i</b> The pipe volume can also be measured directly, see <b>[Options]</b> → <b>Volume</b>   |
| Stability time         | Set stability time   |
| Measurement period     | Set measurement period<br><br><b>i</b> According to DIN EN 806-4, the test time is at least 120 min after an appropriate stability time and a pipe volume < 100 l. For each further 100 l, the measurement period increases by 20 min. |
| Test pressure (target) | Set test pressure<br><br><b>i</b> According to DIN EN 806-4, the test pressure is 150 mbar.  |

### Carrying out a main test

1. Start measurement: [**▶**].
  - Zeroing starts (5 s)
  - The test pressure (target) is built up automatically by the instrument.  
Option
    - > End stability time early: [**Next**]
    - > End measurement period early: [**Next**]
  - Main test is ended.
2. Evaluate measurement result: [**▲**], [**▼**] → [**OK**].
  - The measurement result is displayed
3. Save measurement result: [**Save**].

### Options

- > [**Options**] → **Show Graphic**: a section of past measuring values is displayed in a line graph (zoom function available [**▲**], [**▼**]).
- > [**Options**] → **Volume**: The pipe volume is determined directly (this option is no longer available after the measurement).
- > [**Options**] → **Manometer**: The measuring values are displayed in the same way.
- > [**Options**] → **Overall graphic curve**: the measuring values across the overall measuring time are displayed in a line graph.
- > [**Options**] → **Settings**: The type of test (reference pressure/operating pressure) can be set and the reference pressure of 23 mbar is displayed.

#### 6.2.6.2. Testing with air – pretest

The pretest is carried out to ensure that the test pressure for the pipe system is not exceeded. The pretest is carried out with a maximum test pressure of 3 bar. Once the test pressure is applied, the test time is 10 min.

#### Cution



##### **Avoid damage to the instrument due to high pressure!**

- > For tests with a test pressure of > 1 bar, a high pressure probe (art. no. 0638 1748) must be used.

**Calling up the function:**

>  → **Measurements** → **[OK]** → **Drinking water** → **Test with air** → **Pretest** → **[OK]**.

**Setting parameters**

| Parameter              | Explanation   |
|------------------------|---|
| Stability time         | Set stability time  |
| Measurement period     | Set measurement period  |
|                        |  According to DIN EN 806-4, the test time is 10 min.   |
| Nominal diameter       | Select nominal diameter   |
| Test pressure (target) | Set test pressure   |
|                        |  According to DIN EN 806-4, the test pressure for DN 50 pipes is 3 bar and for DN 50-100 pipes, it is 1 bar. |

1. Edit values: **[Edit]**.
2. Enter values. **[▲]**, **[▼]** and sometimes **[◀]**, **[▶]** → **[OK]**.

**Carrying out a pretest**

1. Build up the test pressure (target) manually, for example with a test pump or a compressor.
2. Start measurement: **[▶]**.
  - Zeroing starts (5 s)
    - Option
      - > End stability time early: **[Next]**
      - > End measurement period early: **[Next]**
  - Pretest is ended.
3. Evaluate measurement result: **[▲]**, **[▼]** → **[OK]**.
  - The measurement result is displayed
4. Save measurement result: **[Save]**.

**Options**

- > **[Options]** → **Show Graphic**: a section of past measuring values is displayed in a line graph (zoom function available **[▲]**, **[▼]**).
- > **[Options]** → **Manometer**: The measuring values are displayed in the same way.

- > **[Options]** → **Overall graphic curve**: the measuring values across the overall measuring time are displayed in a line graph.
- > **[Options]** → **Settings**: The type of test (reference pressure/operating pressure) can be set and the reference pressure of 23 mbar is displayed.

### 6.2.6.3. Test with water

---



A high pressure probe is required for this test.

---

#### Calling up the function:

- > **[Menu]** → **Measurements** → **[OK]** → **Drinking water** → **Test with water** → **[OK]**.

#### Setting parameters

| Parameter          | Explanation   |
|--------------------|---|
| Pipe material      | Select pipe material  |
| Crimp connection   | Enable/disable  |
| Stability time     | Set stability time<br><br><div data-bbox="548 798 576 853" data-label="Image"> </div> The ZVSHK sheet as per DIN EN 806-4 stipulates a stability time of 30 min if there is a significant difference between the ambient and water temperature. |
| Measurement period | Set measurement period  |

| Parameter              | Explanation   |
|------------------------|---|
| Test pressure (target) | <p>Set test pressure</p> <p><b>i</b> The ZVSHK sheet as per DIN EN 806-4 stipulates the following times and pressures:</p> <ul style="list-style-type: none"> <li>• Testing crimp connections: pressure max. 6 bar, test time 15 min</li> <li>• Testing metal multi-layer composite and PVC pipes: pressure max. 11 bar, test time 30 min</li> <li>• Testing PP, PE, PE-X and PB pipes and combined installations made of metal and multi-layer composite pipes: <ul style="list-style-type: none"> <li>◦ Pressure 11 bar, test time 30 min</li> <li>◦ Reduce pressure to 5.5 bar (drain water from system), further test time of 120 minutes.</li> </ul> </li> </ul> |

1. Edit values: **[Edit]**.
2. Enter values. **[▲]**, **[▼]** and sometimes **[◀]**, **[▶]** → **[OK]**.

### Carrying out a test

- i** To prevent the penetration of moisture into the instrument, dry hoses should be used.
- The test pressure (target) must be built up manually.
  - 1. Start measurement: **[▶]**.
  - Zeroing starts (5 s)
    - Option
      - > End stability time early: **[Next]**
      - > End measurement period early: **[Next]**
      - Measurement is cancelled.
  - Testing of crimp connection ended: **[Next]**.

2. Start pressure test: **[Next]**
  - Zeroing starts (5 s)
    - Option
      - > End stability time early: **[Next]**
      - > End measurement period early: **[Next]**
    - Measurement is cancelled.
  - Pressure test is ended.
3. Evaluate measurement result: **[▲], [▼]** → **[OK]**.
  - The measurement result is displayed
4. Save measurement result: **[Save]**.

### Options

- > **[Options]** → **Show Graphic**: a section of past measuring values is displayed in a line graph (zoom function available **[▲], [▼]**).
- > **[Options]** → **Manometer**: The measuring values are displayed in the same way.
- > **[Options]** → **Overall graphic curve**: the measuring values across the overall measuring time are displayed in a line graph.
- > **[Options]** → **Settings**: The type of test (reference pressure/operating pressure) can be set and the reference pressure of 23 mbar is displayed

## 6.2.7. Waste water (DIN EN 1610) with air

### Calling up the function:



- > **[Menu]** → **Measurements** → **[OK]** → **Waste water** → **[OK]**.

### Setting parameters



| Parameter              | Explanation             |
|------------------------|-------------------------|
| Test method            | Select test method      |
| Pipe material          | Select pipe material    |
| Nominal diameter       | Select nominal diameter |
| Stability time         | Set stability time      |
| Measurement period     | Set measurement period  |
| Test pressure (target) | Set test pressure       |

1. Edit values: **[Edit]**.
2. Enter values. **[▲], [▼]** and sometimes **[◀], [▶]** → **[OK]**.

### Carrying out a main test

1. Start measurement: [].
  - Zeroing starts (5 s)
  - Test pressure (target) is built up automatically by the instrument
    - Option
      - > End stability time early: **[Next]**
      - > End measurement period early: **[Next]**
      - Measurement is cancelled.
  - Main test is ended.
2. Evaluate measurement result: [, ] → **[OK]**.
  - The measurement result is displayed
3. Save measurement result: **[Save]**.

### Options

- > **[Options]** → **Show Graphic**: The measuring values are displayed in the form of a line graph. > **[Options]** → **Show Graphic**: a section of past measuring values is displayed in a line graph (zoom function available [, ]).
- > **[Options]** → **Manometer**: The measuring values are displayed in the same way.
- > **[Options]** → **Overall graphic curve**: the measuring values across the overall measuring time are displayed in a line graph.
- > **[Options]** → **Settings**: The type of test (reference pressure/operating pressure) can be set and the reference pressure of 23 mbar is displayed.

## 6.2.8. Programs



### 6.2.8.1. Spot measurement

This program is predefined to carry out a spot measurement of pressure and temperature. The current pressure values (**Press.**, → **Press.**, **Diff Press. ΔP**) and temperature values (**Temp T1 (ext.)**, **Temp T2 (ext.)** and **Diff.Temp.(ext)**) are displayed.



#### Calling up the function:

- > [] → **Measurements** → **[OK]** → **Programs** → **Spot measurement** → **[OK]** → **Enable**.
- Current measuring values are displayed
- Zeroing starts (5 s)
  - Option

|                            |  |
|----------------------------|--|
| Spot measurement           | <ol style="list-style-type: none"> <li>1. <b>[Edit]</b>.</li> <li>2. Edit program name: → <b>[Edit]</b> → <b>[▲]</b>, <b>[▼]</b> and sometimes <b>[◀]</b>, <b>[▶]</b> → <b>[OK]</b>.</li> <li>3. Save changes: <b>[Finished]</b>.</li> </ol>   |
| Configure measurement view | <ol style="list-style-type: none"> <li>1. Select the program: <b>[▲]</b>, <b>[▼]</b> → <b>[Edit]</b>.</li> <li>2. Select <b>Measurement view</b>: <b>[▼]</b> → <b>[Edit]</b>.</li> <li>3. Select parameter: <b>[▲]</b>, <b>[▼]</b> → <b>[+]</b> (enabled), <b>[✖]</b> (disabled)</li> <li>4. Save changes: <b>[Finished]</b>.</li> </ol> |

1. Start measurement: .
  - > End measurement period early: 
    - Measurement is cancelled.
2. Save measurement result: **[OK]**.

### Options

- > > **[Options]** → **Show Graphic**: a section of past measuring values is displayed in a line graph (zoom function available **[▲]**, **[▼]**).
- > **[Options]** → **Configure Graphic**: the measurement parameters to be represented (max. 4) can be displayed () or hidden ().
- > **[Options]** → **Number of lines**: change the number of measuring values per display page.
- > **[Options]** → **Manometer**: The measuring values are displayed in the same way.
- > **[Options]** → **Measurement view**: (this function is not available during a measurement): The reading display menu is opened. Up to 8 measurement parameters can be selected.
- > **[Options]** → **Measurement view order**: (this function is not available during a measurement): the reading display order can be changed.
- > **[Options]** → **Note**: customer-specific notes can be stored.

### 6.2.8.2. Programs 2-5

Four measurement programs for different measurement types can be configured and enabled. The measurement programs are used to save and represent measuring sequences. At the end of the measuring process, the measuring values of a measurement program are automatically saved in a record.

Only one measurement program can be activated in the instrument.





Call up the function:

>  → **Measurements** → [OK] → **Programs** → [OK].

### Selecting and setting a program:

> Select and set program and then confirm with **[Finished]**.

Setting options:

| Parameter                  | Function  |
|----------------------------|---|
| Program                    | <ol style="list-style-type: none"> <li>1. Select the program: [▲], [▼] → [Edit].</li> <li>2. Edit program name: → [Edit] → [▲], [▼] and sometimes [◀], [▶] → [OK].</li> <li>3. Save changes: [Finished].</li> </ol>   |
| Configure measurement view | <ol style="list-style-type: none"> <li>1. Select the program: [▲], [▼] → [Edit].</li> <li>2. Select <b>Measurement view</b>: [▼] → [Edit].</li> <li>3. Select parameter: [▲], [▼] →  (enabled),  (disabled), see table below</li> <li>4. Save changes: [Finished].</li> </ol>                           |
| Measetime                  | <ol style="list-style-type: none"> <li>1. Select the program: [▲], [▼] → [Edit].</li> <li>2. Select <b>Gas time</b>: [▼] → [Edit].</li> <li>3. Enter values. [▲], [▼] and sometimes [◀], [▶] → [OK].</li> <li>4. Save changes: [OK].</li> </ol>   |
| Measuring rate             | <p>The measuring rate is the storage cycle for mean values It is programmed in units of seconds, minutes, whereby the smallest possible measuring rate depends on the number and type of connected probes.</p> <ol style="list-style-type: none"> <li>1. Select the program: [▲], [▼] → [Edit].</li> <li>2. Select <b>Measuring rate</b>: [▼], [▶] → [Edit].</li> <li>3. Enter values. [▲], [▼] and sometimes [◀], [▶] → [OK].</li> <li>4. Save changes: [OK].</li> </ol> |
| Stability time             | <ol style="list-style-type: none"> <li>1. Select the program: [▲], [▼] → [Edit].</li> <li>2. Select <b>Measuring rate</b>: [▼], [▶] → [Edit].</li> <li>3. Enter values. [▲], [▼] and sometimes [◀], [▶] → [OK].</li> <li>4. Save changes: [OK].</li> </ol>  |

## Selectable measurement parameters

| Measurement parameter  | Description   |
|--|---|
| <b>Press.</b>  | Current pressure at the pressure connection $\circ \rightarrow$   |
| <b>Start pressure</b>  | Start pressure at the pressure connection $\circ \rightarrow$   |
| <b>End pressure</b>  | End pressure at the pressure connection $\circ \rightarrow$   |
| <b>Diff Press. <math>\Delta P</math></b>   | Difference between the start pressure and the current pressure at the pressure connection $\circ \rightarrow$ |
| <b><math>\rightarrow \circ</math> Press.</b>   | Current pressure at the pressure connection $\rightarrow \circ$   |
| <b><math>\rightarrow \circ</math> Press. <math>\longleftrightarrow</math> Press.</b> | Differential pressure between the instrument's two pressure connections                                       |
| <b>Press P1 (ext)</b>  | Current pressure of the high pressure probe at probe socket P1  |
| <b>Press P2 (ext)</b>  | Current pressure of the high pressure probe at probe socket P2  |
| <b>Start pressure (ext.)</b>   | Start pressure of the high pressure probe (P1 or P2)  |
| <b>End pressure (ext)</b>  | End pressure of the high pressure probe (P1 or P2)  |
| <b>Diff Press. (ext)</b>   | Difference between the start pressure and the current pressure of the high pressure probe                     |
| <b>P1(ext)<math>\longleftrightarrow</math>P2(ext)</b>                                | Differential pressure between the current pressure at probe socket P1 and P2                                  |
| <b>Temp T1 (ext)</b>   | Current temperature at probe socket T1  |
| <b>Temp T2 (ext)</b>   | Current temperature at probe socket T2  |
| <b>Start temperature (ext)</b>   | Start temperature at T1 or T2   |
| <b>End temperature (ext)</b>   | End temperature at T1 or T2   |
| <b>Diff Temp. (ext)</b>  | Difference between the start temperature and the current temperature at T1 or T2                              |
| <b>T1(ext)<math>\longleftrightarrow</math>T2(ext)</b>                                | Differential temperature between the current temperature at probe socket T1 and T2                            |

| Measurement parameter      | Description   |
|----------------------------|---|
| Flow rate                  | Leak rate calculated via the flow rate sensor   |
| Test press.(targ)          | Required test pressure  |
| Diff Press. $\Delta p$ max | Maximum permissible differential pressure   |
| Diff Temp $\Delta T$ max   | Maximum permissible differential temperature  |
| Test Result                | Option for evaluating the result:<br><b>Pass</b><br><b>Not checked</b><br><b>Failed</b> |

### Enabling/disabling a program:



- > Select the program: [**▲**], [**▼**] → [**Enable**]
- When enabling a program: The program is enabled and the reading display matching the selected program is opened.

Zeroing starts (5 s)

**i** Once the measurement program has been enabled, it is possible to change the parameters **Test press. (targ)**, **Diff. Press.  $\Delta p$  max**, **Diff. Temp  $\Delta T$  max** and **Test Result**.

1. Select the parameter.
2. [**Options**] → [**Edit**] → [**OK**].
3. Enter values. [**▲**], [**▼**] and sometimes [**◀**], [**▶**] → [**OK**].

Starting the program:

1. Start measurement: [].
  - If a test pressure (target) has been set, the pressure can be built up automatically by the instrument (up to 300 mbar). Carry out the steps according to the notes on the display and confirm with [**OK**].
  - If the set test pressure (target) is greater than 300 mbar, the test pressure must be built up manually.
  - Option
    - > End stability time early: [**Next**]
    - > End measurement period early: []
    - Measurement is cancelled.
2. Save measurement result: [**OK**].

### Options

- > **[Options]** → **Show Graphic**: a section of past measuring values is displayed in a line graph (zoom function available [**▲**], [**▼**]).
- > **[Options]** → **Configure Graphic**: the measurement parameters to be represented (max. 4) can be displayed (**+**) or hidden (**×**).
- > **[Options]** → **Number of lines**: change the number of measuring values per display page.
- > **[Options]** → **Manometer**: the measuring values are displayed in the same way.
- > **[Options]** → **Measurement view**: (this function is not available during a measurement): The reading display menu is opened. Up to 8 measurement parameters can be selected.
- > **[Options]** → **Overall graphic curve**: the measuring values across the overall measuring time are displayed in a line graph.

## 6.2.9. Controller test

There are 4 different test types to choose from:

| Test type               | Explanation   |
|-------------------------|---|
| Static pressure         | The static pressure measurement enables defects in the pressure reducer (controller) and the shut-off valve (ball valve) upstream of the consumer to be detected. |
| Flow pressure           | The flow pressure measurement enable defects in the pressure reducer (controller) to be detected.   |
| SSV triggering pressure | This measurement enables you to ascertain whether the triggering pressure of the SSV ( <b>safety shut-off valve</b> ) has been set correctly.                     |
| SRV triggering pressure | The measurement enables you to ascertain whether the triggering pressure of the SRV ( <b>safety relief valve</b> ) has been set correctly.                        |

### 6.2.9.1. Static pressure

The static pressure measurement enables defects in the pressure reducer (controller) and the shut-off valve (ball valve) upstream of the consumer to be detected. It is important to ensure that the valve upstream of the controller is open and the valve upstream of the consumer is closed.

Overview and interpretation of results:

| Description                         | Explanation                               |
|-------------------------------------|---|
| Pressure increases                  | Controller leaks                          |
| Pressure drops and then rises again | Ball valve downstream of controller leaks |
| Pressure is constant                | Ball valve and controller OK              |

#### Calling up the function:

>  → **Measurements** → **[OK]** → **Controller test** → **[OK]**.

1. Select **Static pressure**. **[▲]**, **[▼]** → **[OK]**.

- Measurement is started.

The following values are displayed:

| Parameter      | Explanation   |
|----------------|---|
| Pressure       | Current pressure  |
| Start pressure | Pressure at the start of the measurement                          |
| $\Delta p$     | Pressure differential between start pressure and current pressure |
| Min            | Lowest pressure during the current measurement                    |
| Max.           | Highest pressure during the current measurement                   |

2. End measurement: **[■]**.

3. Save measurement result: **[Save]**.

#### Options

> **[Options]** → **Show Graphic**: a section of past measuring values is displayed in a line graph (zoom function available **[▲]**, **[▼]**).

> **[Options]** → **Manometer**: the measuring values are displayed in the same way.

- > **[Options]** → **Overall graphic curve**: the measuring values across the overall measuring time are displayed in a line graph.

### 6.2.9.2. Flow pressure

#### Calling up the function:

- > **[☰]** → **Measurements** → **[OK]** → **Controller test** → **[OK]**.

1. Select **Flow pressure**. **[▲]**, **[▼]** → **[OK]**.

- Measurement is started

The following values are displayed:

| Parameter | Explanation                                     |
|-----------|---|
| Pressure  | Current pressure                                |
| Min       | Lowest pressure during the current measurement  |
| Max.      | Highest pressure during the current measurement |

2. End measurement: **[■]**.

3. Save measurement result: **[Save]**.

#### Options

- > **[Options]** → **Show Graphic**: a section of past measuring values is displayed in a line graph (zoom function available **[▲]**, **[▼]**).
- > **[Options]** → **Manometer**: the measuring values are displayed in the same way.
- > **[Options]** → **Overall graphic curve**: the measuring values across the overall measuring time are displayed in a line graph.

### 6.2.9.3. SAV\_triggering pressure

For the measurement, it is important to ensure that the valve upstream of the SSV is open and the valve upstream of the consumer is closed. The pressure downstream of the controller (secondary side) in the gas pipe must be increased. If the triggering pressure is exceeded, the SSV is triggered, indicated by a click, and the gas supply is blocked on the primary side. The existing pressure at the time of the click (secondary side) is the SSV triggering pressure.



The SSV stop must then be manually released again.

---

**Calling up the function:**

>  → **Measurements** → [OK] → **Controller test** → [OK].

1. **SAV\_triggering pressure** → [OK].

- Measurement is started
- Gas is released from the pipe into the gas feeding unit. Carry out steps in accordance with the information on the display and confirm with [OK].
- Zeroing starts (5 s).
- The pressure is increased automatically by the instrument.

The following values are displayed:

| Parameter | Explanation                                     |
|-----------|---|
| Pressure  | Current pressure                                |
| Max.      | Highest pressure during the current measurement |

2. End the measurement as soon as the safety shut-off valve closes: .

3. Save measurement result: [Save].

**Options**

> [Options] → **Show Graphic**: a section of past measuring values is displayed in a line graph (zoom function available , ).

> [Options] → **Manometer**: the measuring values are displayed in the same way.

> [Options] → **Overall graphic curve**: the measuring values across the overall measuring time are displayed in a line graph.

**6.2.9.4. SRV triggering pressure**

It is important to ensure that the valve upstream of the SRV is open and the valve upstream of the consumer is closed. The pressure downstream of the controller (secondary side) in the gas pipe must be increased. If the triggering pressure is exceeded, the SRV opens, indicated by a hissing sound, and gas is released on the secondary side. The pressure during opening (secondary side) is the SRV triggering pressure. The SRV closes again automatically once the pressure falls below the triggering pressure.

**Calling up the function:**

>  → **Measurements** → [OK] → **Controller test** → [OK].

1. **SRV triggering pressure** → [OK].

- Measurement is started
- Gas is released from the pipe into the gas feeding unit. Carry out steps in accordance with the information on the display and confirm with **[OK]**.
- Zeroing starts (5 s).
- The pressure is increased automatically by the instrument.

The following values are displayed:

| Parameter | Explanation                                     |
|-----------|---|
| Pressure  | Current pressure                                |
| Max.      | Highest pressure during the current measurement |

2. End the measurement as soon as the safety shut-off valve closes: **[■]**.
3. Save measurement result: **[Save]**.

#### Options

- > **[Options]** → **Show Graphic**: a section of past measuring values is displayed in a line graph (zoom function available **[▲]**, **[▼]**).
- > **[Options]** → **Manometer**: the measuring values are displayed in the same way.
- > **[Options]** → **Overall graphic curve**: the measuring values across the overall measuring time are displayed in a line graph.

## 6.3. Transferring data

### 6.3.1. Record printer

To be able to transfer data to a testo record printer via the infrared or Bluetooth interface (optional), the printer used must be enabled, see Printer, page 33.

Data is printed out via **[🖨️]**. The function is only available if a printout is possible.

### 6.3.2. PC/pocket PC

Data transfer to a PC can take place via USB, IrDA or Bluetooth®. You must also refer to the documentation that comes with the software.



### 6.3.3. Data transfer to IrDA record printer



To transfer data from the testo 324 to the IrDA record printer, the printer can be placed in a storage compartment on top of the testo 324.

## 7 Maintaining the product

### 7.1. Cleaning the measuring instrument

- > If the housing of the measuring instrument is dirty, clean it with a damp cloth. Do not use any aggressive cleaning agents or solvents! Mild household cleaning agents and soap suds may be used.

### 7.2. Regular calibration



Leakage measuring instruments must be calibrated once a year in accordance with DVGW guideline G5952. Calibration is performed by Testo Customer Services or a service centre authorised by testo.

### 7.3. Replacing the gas bladder

The gas bladder for the feeding unit must be replaced every 5 years (production date stated on barcode sticker on the case). It is replaced by Testo Customer Service or a service centre authorized by Testo.

- i** After replacing the gas bladder, flushing is required (fill and empty the feeding unit once).

#### Identifying the production date

| Barcode sticker 1  | Barcode sticker 2  |
|--|--|
| <p>Order no.: 0563 3240<br/>                     Serial no.: 60373663<br/>                     Set no.: 0563 3240</p>  <p style="font-size: small;">(93) 05633240 (21) 60373663</p> | <p><b>0563 3240 70</b></p>  <p>4 029547 012488<br/> <b>Made in Germany</b><br/>                     Testo AG <b>504</b> 1 ST</p> <p style="text-align: center;">1 2</p> |

- 1 Year of production (example: 5 stands for the year 2015)
- 2 Month of production (example: 04 stands for the month of April)

## 8 Tips and assistance

### 8.1. Questions and answers

| Question  | Possible causes/solution   |
|---|--|
| Measuring instrument switches itself off or will not switch on. | Battery spent.<br>> Charge battery   |
| No pressure can be build up, or the pressure is falling.        | Inlet or outlet is open.<br>There is a leak.<br>> Check connections.<br>> Check system for leaks.              |
| testo 324 stops responding.                                     | <br>> Press reset button (1). |

If we have not been able to answer your question, please contact your dealer or Testo Customer Service. For contact details, see the back of this document or visit the website [www.testo.com/service-contact](http://www.testo.com/service-contact).

### 8.2. Accessories and spare parts

| Description  | Article no. |
|--|-------------|
| High pressure probe up to 25 bar   | 0638 1748   |
| testo 316-2  | 0632 3162   |
| testo 316-1  | 0632 0316   |
| Surface probe  | 0604 0194   |
| Connecting line, length 1.5 m  | 0430 0143   |
| Connection hose (2 m) for extension purposes<br>Pressure side with coupling pin, test side with coupling | 0554 3158   |
| Dual valve connector   | 0554 3161   |
| Conical test stop 1/2"   | 0554 3151   |

| <b>Description</b>  | <b>Article no.</b> |
|---|--------------------|
| Conical test stop 3/4"  | 0554 3155          |
| High-pressure stage stop 3/8" & 3/4"                                    | 0554 3163          |
| High-pressure stage stop 1/2" & 1"                                      | 0554 3164          |
| High-pressure stage stop 3/4" & 1 1/4"                                  | 0554 0533          |
| High-pressure connection  | 0554 3139          |
| Pressure release plug   | 0554 3171          |
| Hose set with stop valve  | 0554 3172          |
| Connection hose 2 m, on both sides with quick-release coupling          | 0554 0529          |
| Single pipe counter cap   | 0554 3156          |
| Mains unit  | 0554 1096          |
| IrDA record printer   | 0554 0549          |
| testo BLUETOOTH®/ IRDA printer  | 0554 0620          |
| Spare printer paper (6 rolls)   | 0554 0568          |
| PC software easyHeat  | 0554 3332          |
| USB cable   | 0449 0047          |
| System case incl. feeding unit, connection block and connection hose    | 0516 3240          |
| Instrument case (height: 130 mm) for instrument, probes and accessories | 0516 3300          |
| Carrying strap  | 0516 0402          |
| TopSafe for testo 316-1   | 0516 0189          |
| ISO calibration certificate for sensor                                  | 0520 0005          |

For a complete list of all accessories and spare parts, please refer to the product catalogues and brochures or visit our website [www.testo.com](http://www.testo.com)

### 8.3. Updating the instrument software

Under [www.testo.com/download-center](http://www.testo.com/download-center) you can download the current instrument software (Firmware) for testo 324 (registration required).

- > Unplug the mains unit and switch off the testo 324.
- 1. Hold down **[▲]**.
- 2. Plug in the mains unit, continue holding down **[▲]**.
- The display shows **Firmware update** along the bottom edge.

3. Release [▲].
4. Insert the connecting cable (0449 0047) into the USB-port on the instrument, then connect it to the PC.
  - Your PC recognises the testo 324 as a removable medium.
5. Copy the new file (ap324rel.bin) to the detected removable medium.
  - On the display the status bar progresses from left to right. This process may take a few minutes.
6. Disconnect the connecting cable from the testo 324.
  - Once the instrument software (firmware) has been updated, the system will automatically reboot and is ready for use.



**Testo SE & Co. KGaA**

Celsiusstraße 2

79822 Titisee-Neustadt

Germany

Telefon: +49 7653 681-0

E-Mail: [info@testo.de](mailto:info@testo.de)

Internet: [www.testo.com](http://www.testo.com)