

Mini Hawk installation manual



“

HAWK

Introduction

Thank you for purchasing the mini-hawk model. We at T-ONE have devoted 1 year of energy and time to this model. After repeated verification and modification, we hope to restore the appearance and details of the real machine as much as possible while providing customers with a perfect flight experience. Please note that the photos in this instruction manual show some views of the prototype. The release version of the model may have undergone some modifications and upgrades. This manual describes the assembly of the model. Before you start building and setting up the aircraft, please make sure you have read and understood the instruction manual. If you have any question, Please do not hesitate to contact us.



”

1、 Gear installation

(1).Nose gear installation

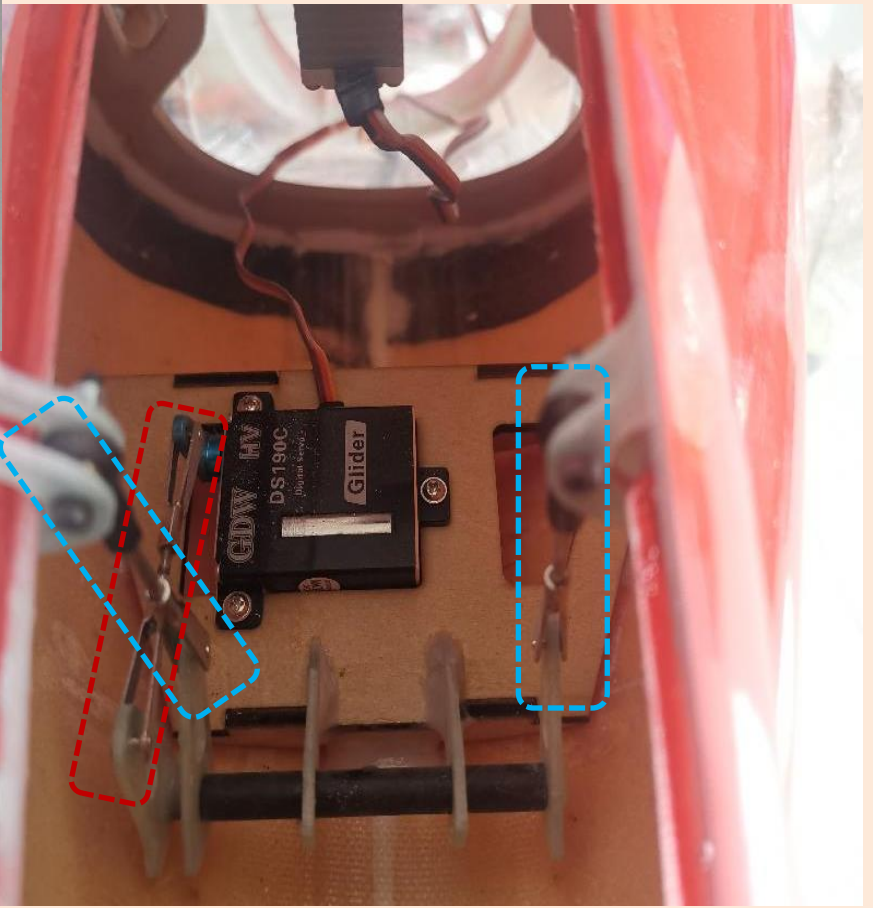
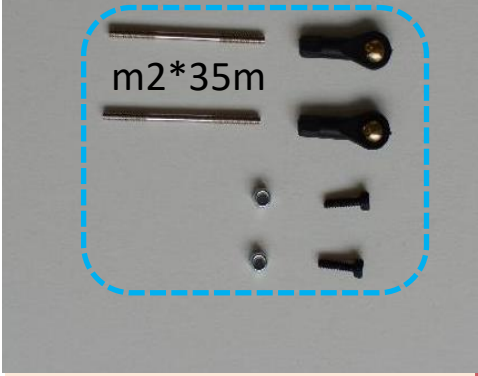
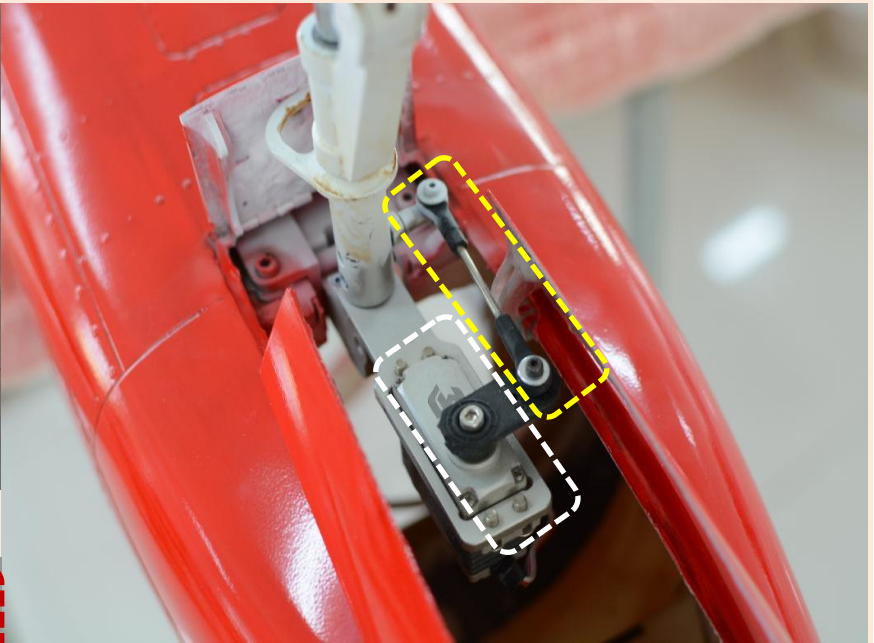
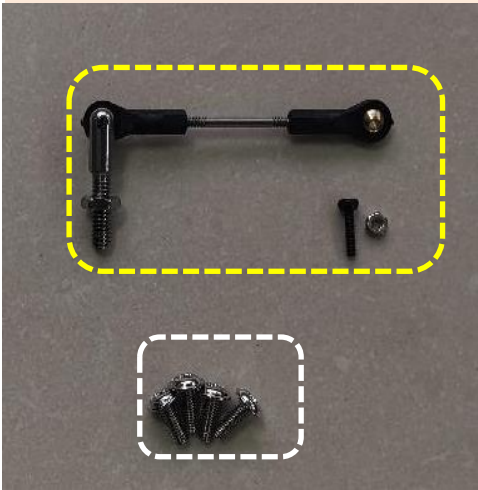

(2).Main gear door servo installation

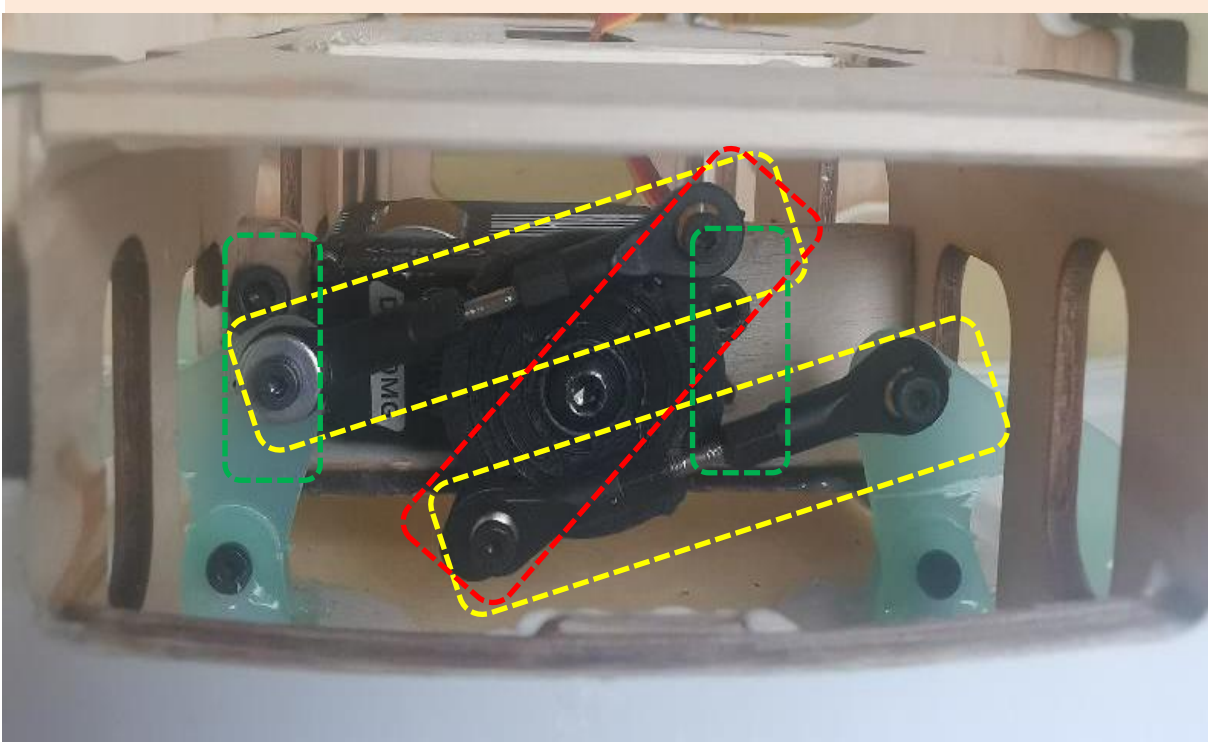
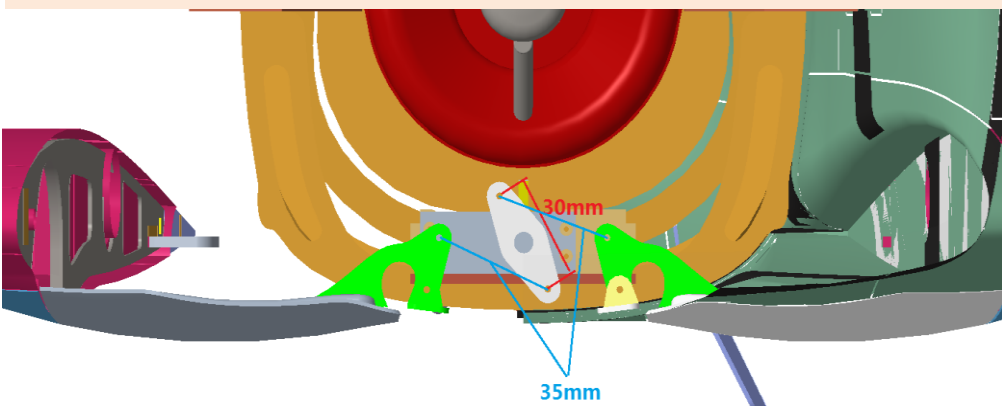
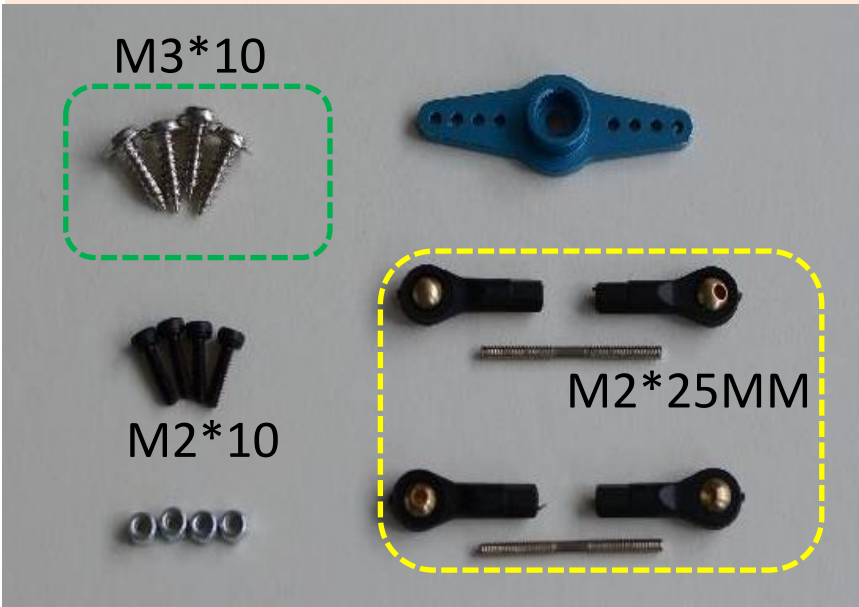

2. Aileron servo installation

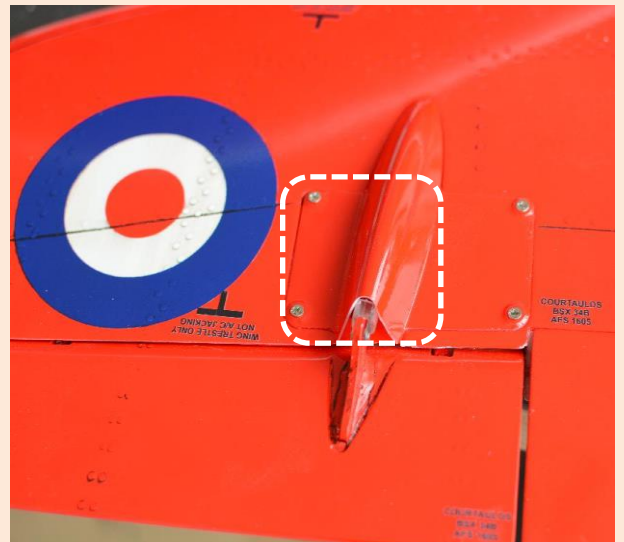
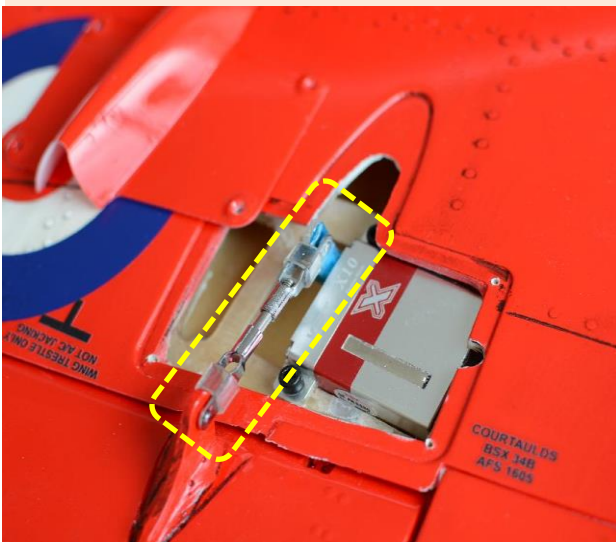
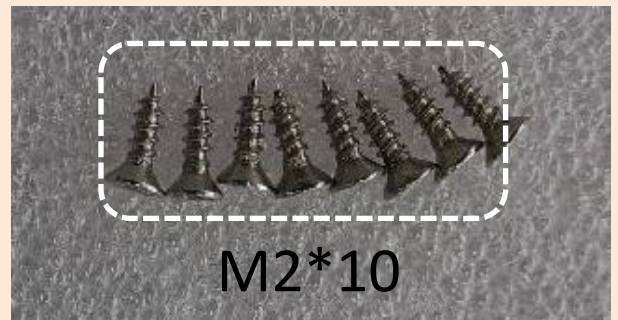

3. Flap servo installation

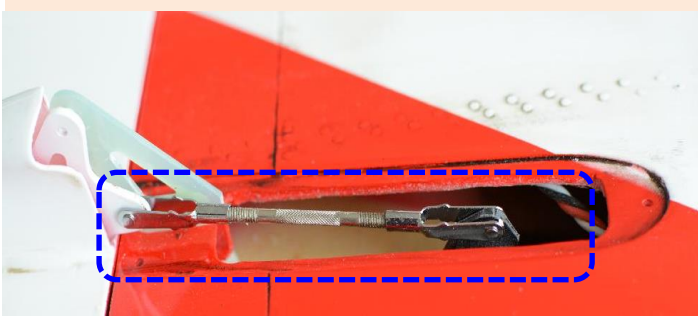
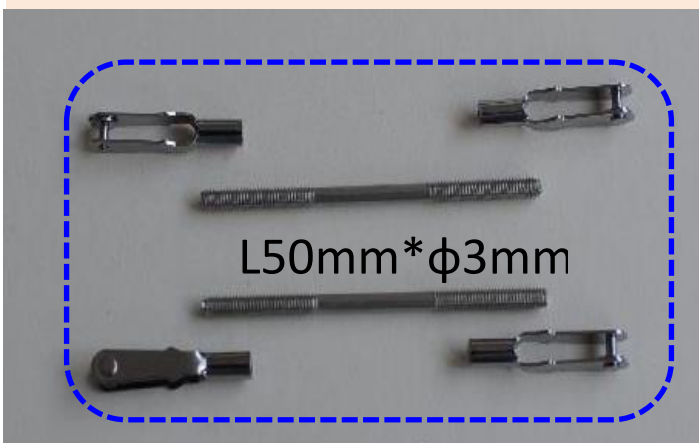

4. Horizontal tail installation

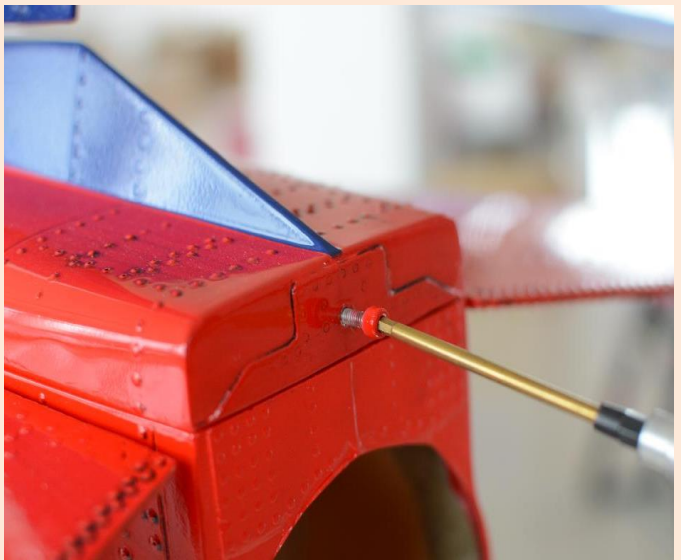
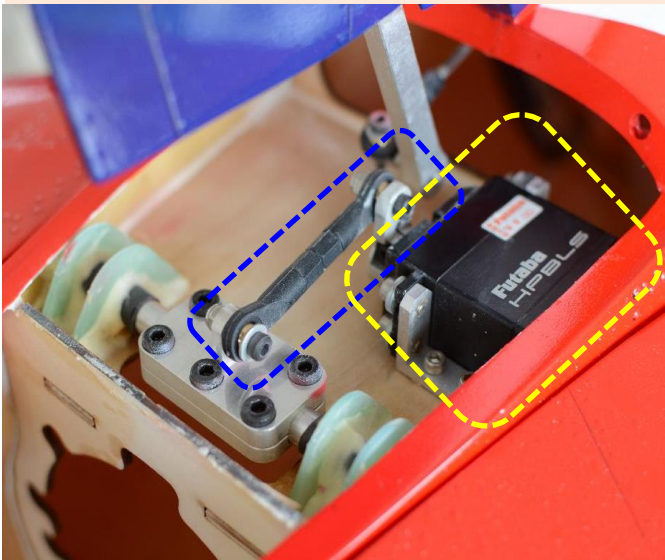
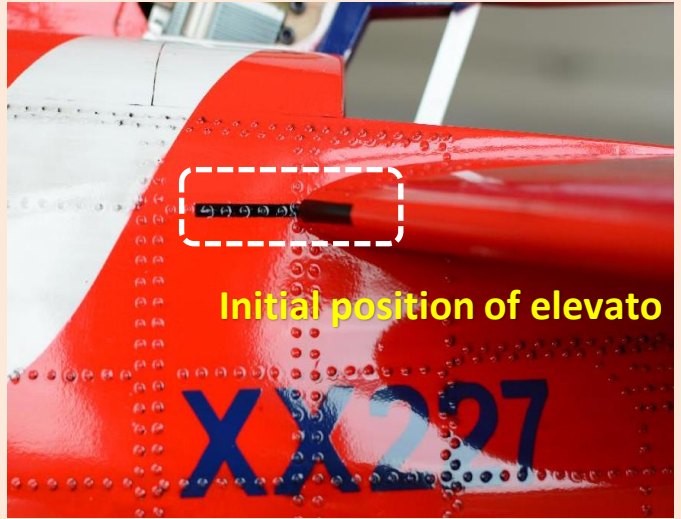
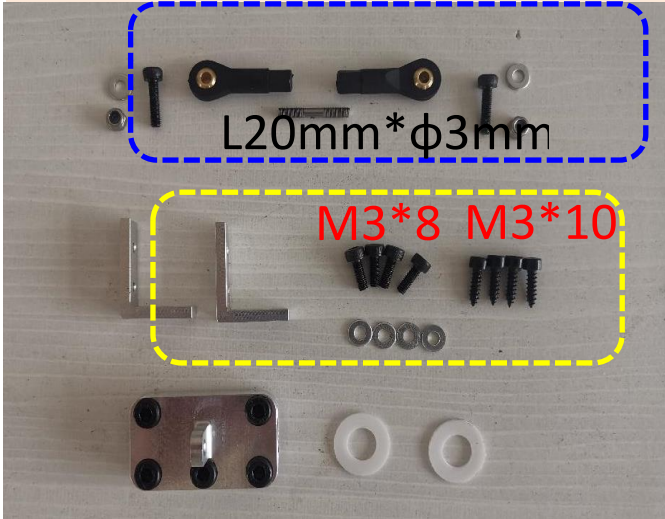

5. Vertical tail installation

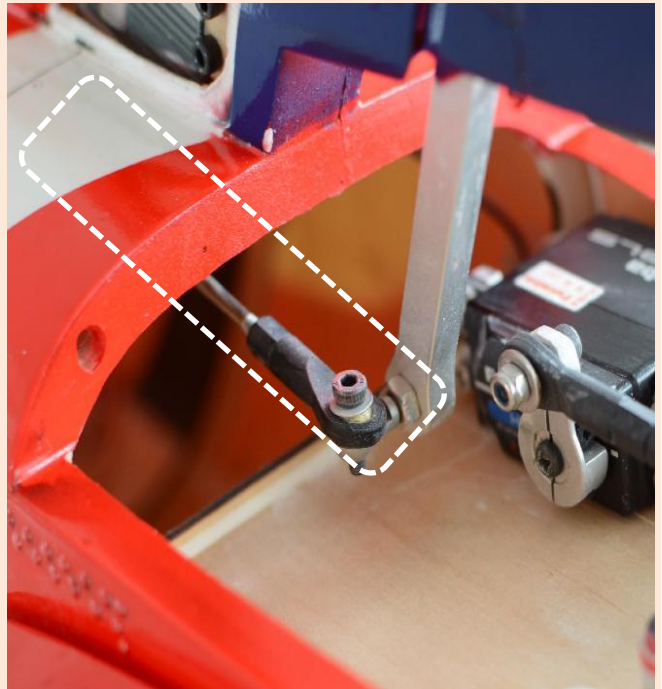
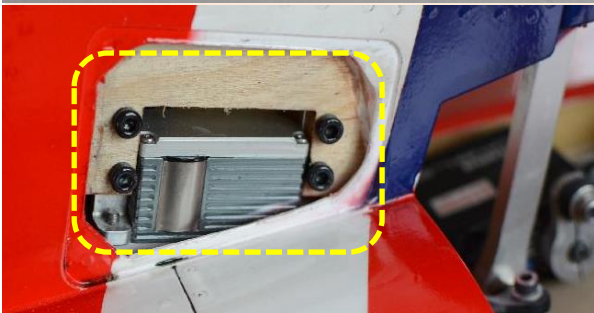

6、Fuselage,wing,engine,drop tank,missiles fixed

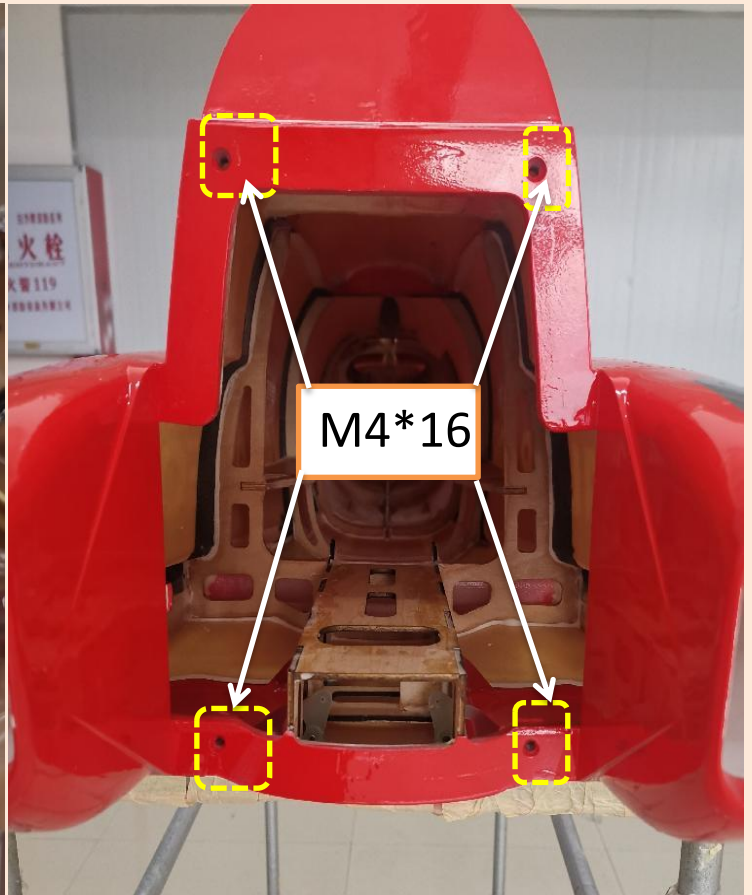

7、 Equipment installation



8、 Flight parameters

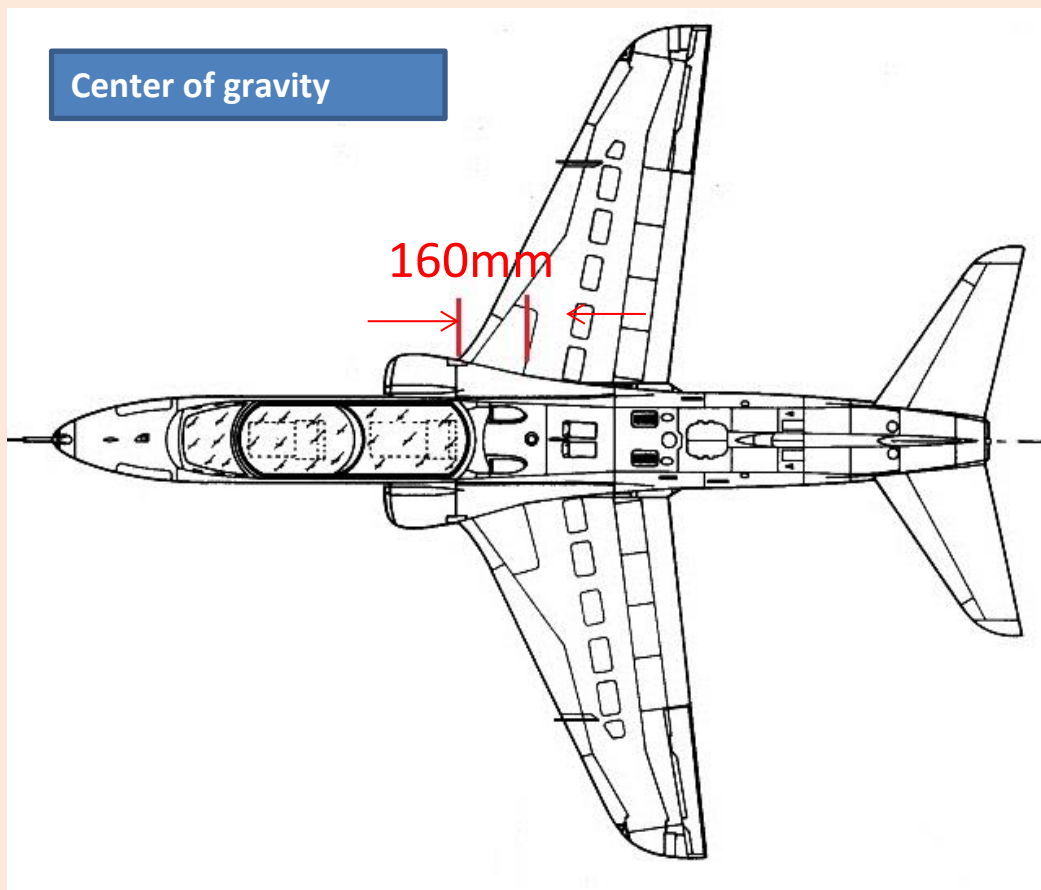

	Data
Aileron 副翼	$\pm 22\text{mm}$
Flap 襟翼	20mm, 40mm
Elevator 升降	$\pm 35\text{mm}$
Rudder 方向	$\pm 25\text{mm}$
CG 重心	160mm