

DAKOTA JACKSON



Collections

dakotajackson.com

DAKOTA JACKSON

Integrity and the quest for impeccable elegance in design have been the guiding principles during my 50 years in creating and manufacturing fine furniture. In the early 70's the drive was to become a true "House of Furniture" where the experienced designer, like the choreographer created the intricate ballet of fabrication. I hand built my factories, a theatre where trained craftspeople, quality materials, hand work and machinery moved with synchronicity within the dance of production. A line on paper drawn in the studio came to life on the factory floor. Every completed piece was destined to become a treasured possession.

Today the "House" that Jackson built continues to embody those founding principles. The company has expanded in many directions: exciting new products, market sectors, international distribution and amongst other endeavors our ongoing collaboration beginning in 1998 with Steinway and Sons, the unparalleled House of Pianos. We have fostered good will through understanding the needs and working closely with our clients - the design professionals. Above all, I have always upheld my commitment to producing the finest work.

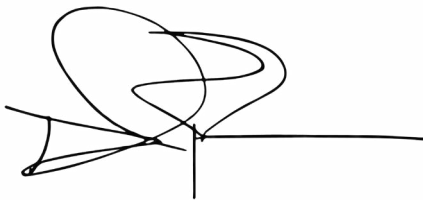
A handwritten signature in black ink, consisting of a series of overlapping loops and a horizontal line extending to the right.

Dakota Jackson

DAKOTA JACKSON
DJ



GUI Dining Table with Sonata Arm Chairs

Photographed in the
Dakota Jackson New York City Showroom D&D Building

COLLECTIONS

Casegoods ▶

Occasional Pieces ▶

Pull Up Seating ▶

Barstools ▶

Occasional Seating ▶

Fully Upholstered Seating ▶

Executive Chairs ▶

Desks & Writing Tables ▶

NEW COLLECTIONS

Pavilion ▶

Chess ▶



Save this Catalog to your files.

Periodically go to the link to download the latest updates.

To print or download a tearsheet tap on the front image of a piece sending you to the web page.

On the web page download the tearsheet to save or print.

Return to the Catalog for further product viewing.

dakotajackson.com/catalog

Casegoods



DAKOTA JACKSON
DJ



Arabesque

TABLES

ARABESQUE TABLES

Description

Kiln-dried Maple and composite substrates, Polished Polyresin finish. Available in Chalk, Ruby, Azure, Aubergine and Coal lacquer. Also available in all veneer groups.



Cocktail Set approx. combined: 55"w x 40"d x 17"h

Large Cocktail Table

55"w x 30"d x 17"h



Small Cocktail Table

33"w x 22"d x 17"h

Polished Azure Lacquer (shown at bottom)

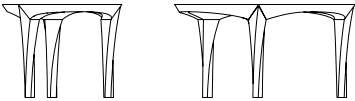

DAKOTA
JACKSON

Dakota Jackson,
Flagship Showroom
979 Third Ave #501,
New York, NY 10022
Tel. 212.838.9444
info@dakotajackson.com



*Actual color and finish may vary slightly



DAKOTA JACKSON
DJ



Arabesque

DINING TABLE

ARABESQUE DINING TABLE

Description

98" w x 46" d x 30" h

As shown: Polished Azure Lacquer

Carved Kiln-dried Maple legs with Polished

Stainless-Steel Sabots and Polished Polyresin Finish.

Available in Chalk, Ruby, Azure, Aubergine and Coal lacquer.

Available in all veneer groups.



DAKOTA
JACKSON

Dakota Jackson,
Flagship Showroom
979 Third Ave #501,
New York, NY 10022
Tel. 212.838.9444
info@dakotajackson.com



*Actual color and finish may vary slightly



DAKOTA JACKSON
DJ



Aria

COCKTAIL TABLE

ARIA COCKTAIL TABLE

Description

54"w x 36"d x 15"h

Polished Polyresin Finish.

Available in Chalk, Ruby, Azure, Aubergine and Coal Lacquer.



As shown: Polished Polyresin Azure Lacquer

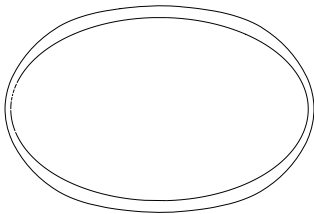
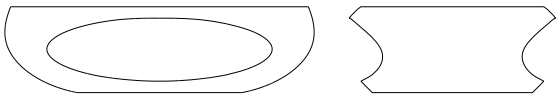

DAKOTA
JACKSON

Dakota Jackson,
Flagship Showroom
979 Third Ave #501,
New York, NY 10022
Tel. 212.838.9444
info@dakotajackson.com



*Actual color and finish may vary slightly



DAKOTA JACKSON
DJ



Aria

BREAKFAST TABLE

ARIA BREAKFAST TABLE

Description

60" dia. x 30"h

Polished Polyresin Lacquered Base with Clear 3/4" tempered Glass top.

Available in Chalk, Ruby, Azure, Aubergine and Coal lacquer.

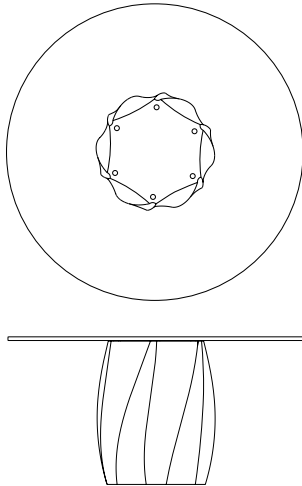

As shown: Polished Polyresin Chalk (top) and Aubergine (bottom).



DAKOTA
JACKSON

Dakota Jackson,
Flagship Showroom
979 Third Ave #501,
New York, NY 10022
Tel. 212.838.9444
info@dakotajackson.com



*Actual color and finish may vary slightly



DAKOTA JACKSON
DJ



bent-o

ÉTAGÈRE

BENT-O ÉTAGÈRE

Description

90"w x 18"d x 87.75"h

3 veneered rectangular section with 5 vertically stacking Polished Stainless Steel sections. Polished Stainless Steel base plate.

Available in all veneer groups.

As shown: Natural Anigre and Polished Stainless Steel (back) or Mahogany and Polished Stainless Steel (front)

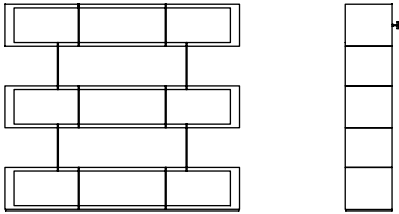

DAKOTA
JACKSON

Dakota Jackson,
Flagship Showroom
979 Third Ave #501,
New York, NY 10022
Tel. 212.838.9444
info@dakotajackson.com

*Actual color and finish may vary slightly



DAKOTA JACKSON
DJ



bent-o

LOW CASE

BENT-O LOW CASE

Description

90"w x 18"d x 87.75"h

4 doors with varied trays and doors. Shelves built into outside doors. Polished Stainless Steel details with 5/8" glass top ledge.

Available in all veneer groups.

As shown: Polished Makore and Polished Stainless Steel

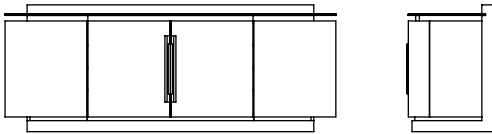

DAKOTA
JACKSON

Dakota Jackson,
Flagship Showroom
979 Third Ave #501,
New York, NY 10022
Tel. 212.838.9444
info@dakotajackson.com



*Actual color and finish may vary slightly



DAKOTA JACKSON
DJ



Bridges

SIDE & COCKTAIL TABLES

BRIDGES SIDE & COCKTAIL TABLES

Description

Side Table

25"w x 17"d x 20"h

3/4" Low Iron Glass top and shelf with veneered frame and brass accents.

All veneer groups available.

All metal finishes available.

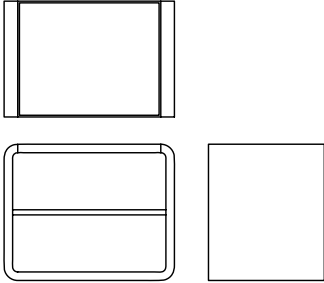
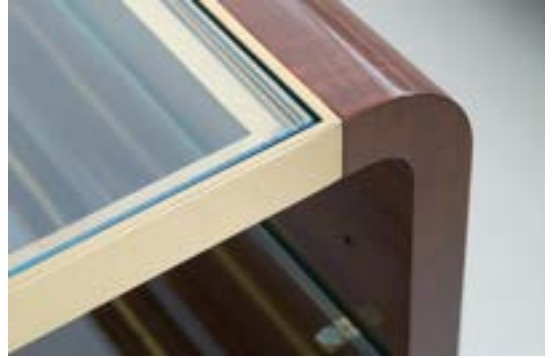

Cocktail Table

40"w x 40"d x 16"h

3/4" Low Iron Glass top and shelf with veneered frame and brass accents.

All veneer groups available.

All metal finishes available.



Shown as: Quarter Figured Walnut with Brass Accents.

DAKOTA
JACKSON

Dakota Jackson,
Flagship Showroom
979 Third Ave #501,
New York, NY 10022
Tel. 212.838.9444
info@dakotajackson.com



DAKOTA JACKSON
DJ



Broulay

DINING TABLE

BROULAY DINING TABLE

Description

55"w x 24.75"d x 30.25"h

Available in Polished Sycamore with inset leather writing surface and leather drawer face. Veneered Sycamore legs and Polished Stainless Steel sabots. DJ Black Leather or Marina Grey included. Available in a select range of DJ Leather for an additional charge, or COL upon approval. COL required 18 sq ft clean desktop quality leather.

As shown: DJL Marina Grey, Polished Sycamore

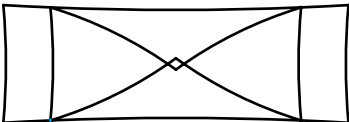
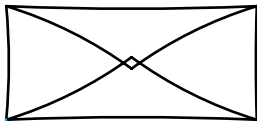

DAKOTA
JACKSON

Dakota Jackson,
Flagship Showroom
979 Third Ave #501,
New York, NY 10022
Tel. 212.838.9444
info@dakotajackson.com



*Actual color and finish may vary slightly



DAKOTA JACKSON
DJ



Broulay

GAME TABLE

BROULAY GAME TABLE

Description

40"w x 40"d x 29"h

Intersecting contrasting inlayed arced motif. Straight veneer pedestal base with Polished Stainless Steel baseplate.

As shown: Polished Natural Afromosia with contrasting Macassar Ebony inlays.

All wood groups available.



Table top pattern.

DAKOTA
JACKSON

Dakota Jackson,
Flagship Showroom
979 Third Ave #501,
New York, NY 10022
Tel. 212.838.9444
info@dakotajackson.com



DAKOTA JACKSON
DJ



Bump
CABINET

BUMP WAVE CABINET

Description

4 compartments with 1 adjustable shelf per compartment. Round wave detail vertically across door faces. Contrasting veneer on apron. Polished Stainless Steel legs. Available in all veneer groups and lacquer in Chalk, Ruby, Azure, Aubergine, and Coal.

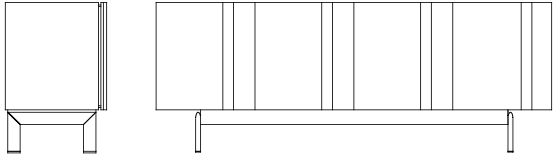

As shown: Polish Chalk Lacquer with Ebonized Mahogany apron.

DAKOTA JACKSON

Dakota Jackson,
Flagship Showroom
979 Third Ave #501,
New York, NY 10022
Tel. 212.838.9444
info@dakotajackson.com



As shown: Satin Natural Anigre

*Actual color and finish may vary slightly



DAKOTA JACKSON
DJ



Calypso
DINING TABLE

CALYPSO DINING TABLE

Description

As shown: Polished Polyresin dyed Walnut veneer table top.
Matte Polyresin solid wood base and Ash veneer contrasts.

All veneer groups available.



DAKOTA JACKSON

Dakota Jackson,
Flagship Showroom
979 Third Ave #501,
New York, NY 10022
Tel. 212.838.9444
info@dakotajackson.com



*Actual color and finish may vary slightly



DAKOTA JACKSON
DJ



Camino

DINING TABLE

CAMINO DINING TABLE

Description

96" w x 44" d x 30" h

Extending: 132" w x 44" d x 30" h (shown at right)

As shown: Polished Makore with Polished Stainless Steel detailing and Mother of Pearl button inlays on table top.
Extending table with two 18" leaves at ends. Leaf storage box sold separately.



Shown as 96 inches no leaves.

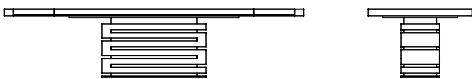
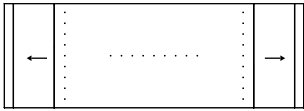
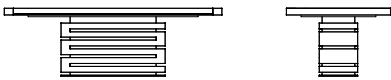
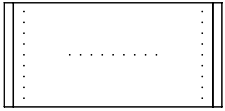

DAKOTA
JACKSON

Dakota Jackson,
Flagship Showroom
979 Third Ave #501,
New York, NY 10022
Tel. 212.838.9444
info@dakotajackson.com



Features Mother of Pearl Table Inlays top inlays. Extending table top (right), Inlay detail photo (left).



*Actual color and finish may vary slightly



DAKOTA JACKSON
DJ



Cascade

DINING TABLE

CASCADE DINING TABLE

Description

96"w x 42"d x 29.5"h

Laminated Hardwood table base, Polished Stainless Steel Fittings, 3/4" Tempered Glass Table Top. Available in all Veneer Groups and Polished Lacquer in Chalk, Coal, Ruby, Azure and Aubergine.



As shown: Chalk Polished Lacquer

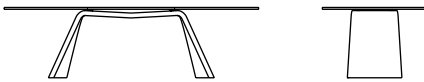
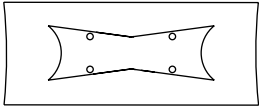

Stainless Steel Fitting Detail

DAKOTA
JACKSON

Dakota Jackson,
Flagship Showroom
979 Third Ave #501,
New York, NY 10022
Tel. 212.838.9444
info@dakotajackson.com



*Actual color and finish may vary slightly



DAKOTA JACKSON
DJ



Ceylon
BED

CEYLON BED

Description

Arced cant ladder back headboard and frame in Cherry or Maple. Designed for use with mattress only, other options available. Bed sold without mattress.

Queen Bed: 66.5"w x 90.5"d x 44.5"h

Requires 60"w x 80"d x 10"h mattress (standard)

Eastern King Bed: 82.5"w x 90.5"d x 44.5"h

Requires 72"w x 80"d x 10"h mattress (standard)

California King Bed: 78.5"w x 94.5"d x 44.5"h

Requires 72"w x 84"d x 10"h mattress (standard)

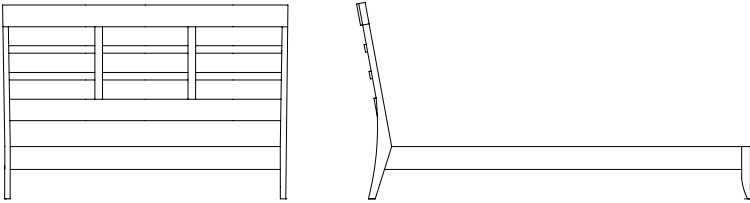

DAKOTA
JACKSON

Dakota Jackson,
Flagship Showroom
979 Third Ave #501,
New York, NY 10022
Tel. 212.838.9444
info@dakotajackson.com



*Actual color and finish may vary slightly



DAKOTA JACKSON
DJ



Checkers

CREDENZA

CHECKERS CREDENZA

Description

84" w x 22" d x 30" h

Checked Marquetry Inlay details and Stainless Steel accents. 4 drawers across the top, below 2 file drawers, 4 doors in the middle each with 1 adjustable shelf. Inset glass top.

All veneer groups available.

All metal finishes available.

Standard Finishes

Espresso Mahogany

All veneer groups available.

Shown as: Satin Walnut with Stainless Steel accents.

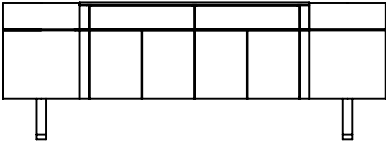

*Actual color and finish may vary slightly



DAKOTA JACKSON
DJ



Chess
ROUND TABLE

CHESS ROUND TABLE

Description

60" dia x 30" h

54" dia. x 30" h

42" dia. x 30" h

Table top sunburst design.

Chess piece inspired base available with Garland detail.

All veneer groups available.

Shown as: Espresso Mahogany

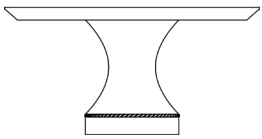
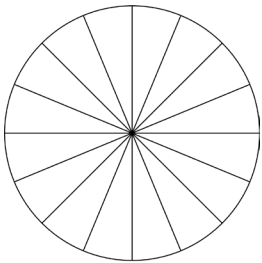

DAKOTA
JACKSON

Dakota Jackson,
Flagship Showroom
979 Third Ave #501,
New York, NY 10022
Tel. 212.838.9444
info@dakotajackson.com



*Actual color and finish may vary slightly



DAKOTA JACKSON
DJ



Chess

GLASS ROUND TABLE

CHESS GLASS TOP ROUND TABLE

Description

60" dia x 30" h

54" dia. x 30" h

42" dia. x 30" h

High Lustre Poly Resin Base with Sunburst cap. 3/4" Clear
Float Glass top. Polished Stainless Steel posts.

All veneer groups available.

Shown as: Espresso Mahogany

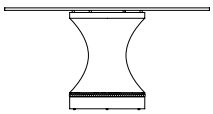
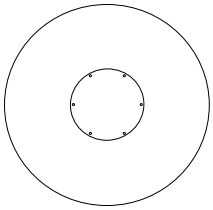

DAKOTA
JACKSON

Dakota Jackson,
Flagship Showroom
979 Third Ave #501,
New York, NY 10022
Tel. 212.838.9444
info@dakotajackson.com



*Actual color and finish may vary slightly



DAKOTA JACKSON
DJ



Chess

OVAL TABLE

CHESS OVAL DINING TABLE

Description

108" w x 48" d x 30" h

Oval Table top sunburst design.

Chess piece inspired base with Garland detail.

All veneer groups available.

Shown as: Espresso Mahogany

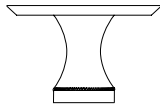
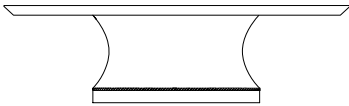
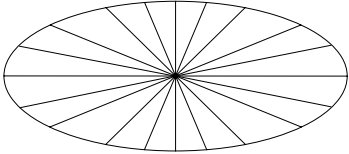

DAKOTA
JACKSON

Dakota Jackson,
Flagship Showroom
979 Third Ave #501,
New York, NY 10022
Tel. 212.838.9444
info@dakotajackson.com

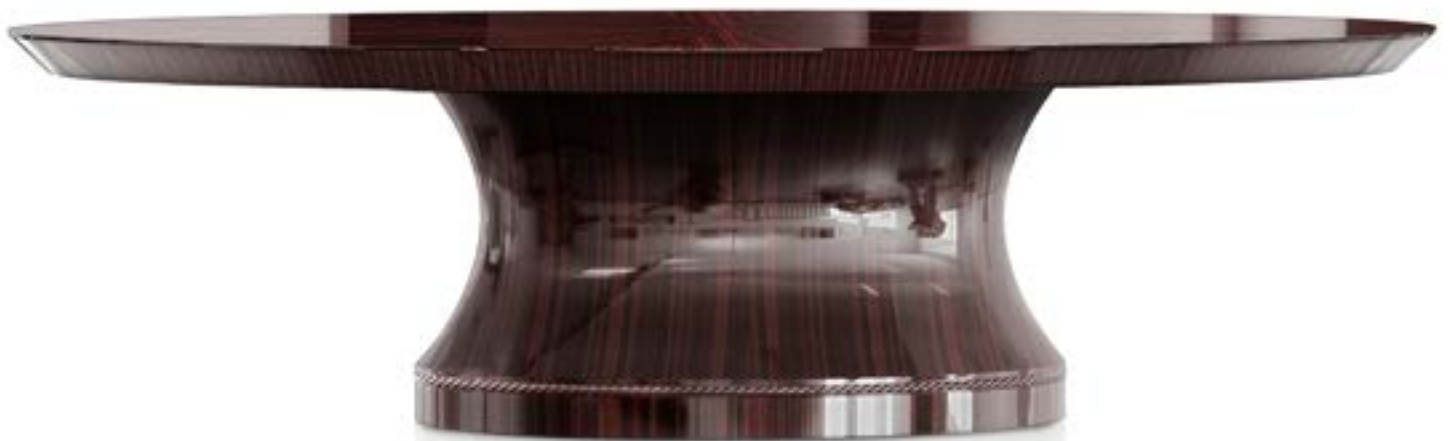

*Actual color and finish may vary slightly



DAKOTA JACKSON
DJ



Chess

OVAL TABLE

CHESS OVAL DINING TABLE

Description

108" w x 48" d x 30" h

Oval Table top sunburst design.

Chess piece inspired base available with Garland detail.

All veneer groups available.

Shown as: Polished Figured Sycamore

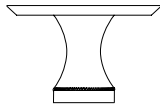
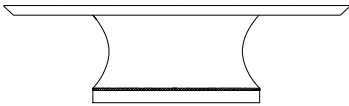
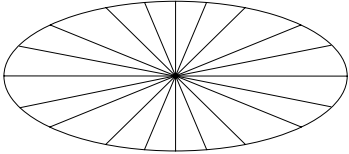

DAKOTA
JACKSON

Dakota Jackson,
Flagship Showroom
979 Third Ave #501,
New York, NY 10022
Tel. 212.838.9444
info@dakotajackson.com



*Actual color and finish may vary slightly



DAKOTA JACKSON
DJ



Chess

DINING TABLE WITH BOWED ENDS

CHESS DINING TABLE WITH BOWED ENDS

Description

96"w x 46"d x 30"h

Extended: 132"w x 46"d x 30"h

High Lustre Poly-Resin Sunburst patterned table top with Satin finished end caps. Polished Base with inset Hand Carved Garland. Optional 18" extending Polished leaves.

All veneer groups available.

As Shown: High Lustre Rosewood Veneer

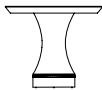
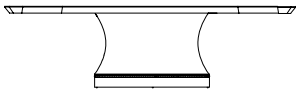
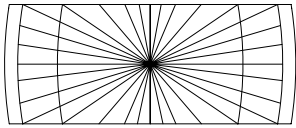

DAKOTA
JACKSON

Dakota Jackson,
Flagship Showroom
979 Third Ave #501,
New York, NY 10022
Tel. 212.838.9444
info@dakotajackson.com



*Actual color and finish may vary slightly



DAKOTA JACKSON
DJ



Epoch
DINING TABLE

EPOCH TABLES

Description

Crescent shaped, Carved pedestal base and partial sunburst table top pattern.
All veneer groups available.

Dining Table (shown at front)

96" w x 44" d x 30" h

Partial Sunburst pattern table top and gently arced on all 4 sides.

As shown: Polished Natural Mahogany



Extending Table

Pullout ledges at ends accepts 18" leaves. Leaf storage box sold separately.

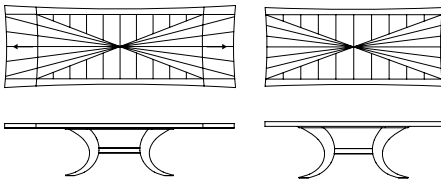

DAKOTA JACKSON

Dakota Jackson,
Flagship Showroom
979 Third Ave #501,
New York, NY 10022
Tel. 212.838.9444
info@dakotajackson.com



DAKOTA JACKSON
DJ



Executive Suite

CONSOLE

EXECUTIVE SUITE CONSOLE

Description

91"w x 21"d x 32.25"h

Polished Polyresin finish. Polished Stainless Steel frame and inlay accents. 4 drawers and 2 full lateral drawers frame an open center window.

Available in all veneer groups.

As Shown: Polished Elm Burl with Stainless Steel accents.

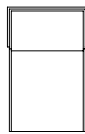
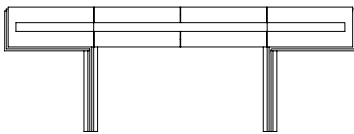

DAKOTA
JACKSON

Dakota Jackson,
Flagship Showroom
979 Third Ave #501,
New York, NY 10022
Tel. 212.838.9444
info@dakotajackson.com



*Actual color and finish may vary slightly



DAKOTA JACKSON
DJ



Executive Suite

CREDENZA

EXECUTIVE SUITE CREDENZA

Description

92"w x 21"d x 32.25"h

Polished Polyresin finish. Polished Stainless Steel frame and inlay accents. 4 top drawers, 2 lateral files, and 2 open storage spaces with adjustable shelves.

Available in all veneer groups.

As Shown: Polished Elm Burl with Stainless Steel accents.

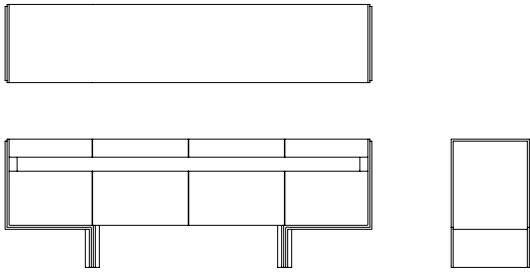

DAKOTA
JACKSON

Dakota Jackson,
Flagship Showroom
979 Third Ave #501,
New York, NY 10022
Tel. 212.838.9444
info@dakotajackson.com

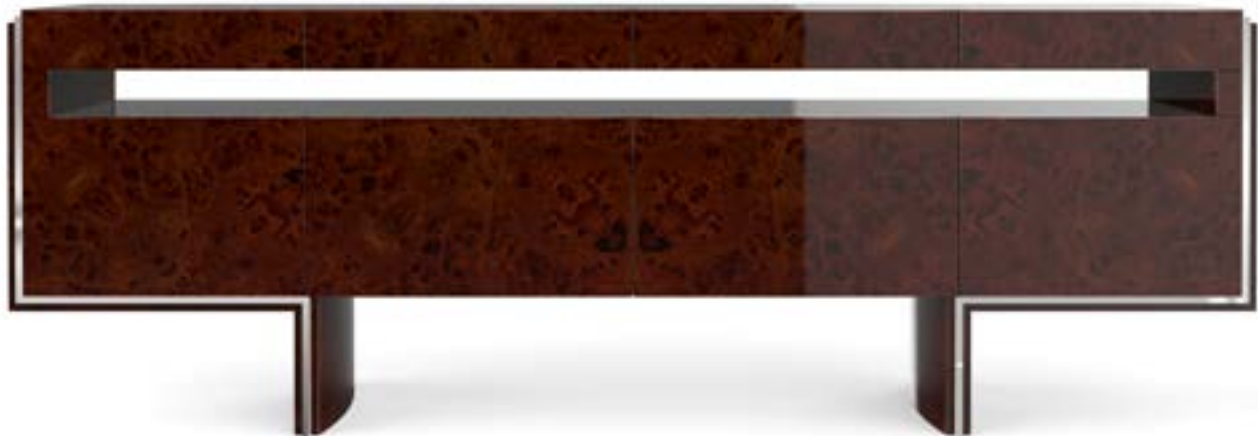

*Actual color and finish may vary slightly



DAKOTA JACKSON
DJ



Grand

COCKTAIL TABLE

GRAND COCKTAIL TABLE

Description

54"w x 36"d x 20.75"h

Polished and Matte Straight grain veneers with contrasting reveals. Stainless Steel Inlays and 3/4" Clear Float Tempered Glass.

All veneer groups available.

As shown: Polished Polyresin Macassar Ebony; Matte Polyresin Natural Sycamore

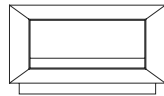
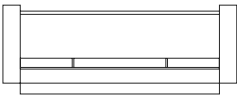
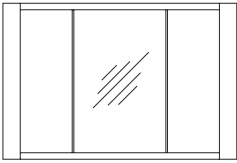

DAKOTA
JACKSON

Dakota Jackson,
Flagship Showroom
979 Third Ave #501,
New York, NY 10022
Tel. 212.838.9444
info@dakotajackson.com



DAKOTA JACKSON
DJ



Grand
CREDENZA

GRAND CREDENZA

Description

84"w x 24"d x 30"h

Bow front cabinet with 4 doors, 4 adjustable shelves and 4 pull out trays. Other configurations available. Polished Stainless Steel leg accents and

All wood groups available.

As shown: Polished Macassar Ebony with Maple inlays, and Polished Stainless Steel sled bases and door pulls.

DAKOTA
JACKSON

Dakota Jackson,
Flagship Showroom
979 Third Ave #501,
New York, NY 10022
Tel. 212.838.9444
info@dakotajackson.com



*Actual color and finish may vary slightly



DAKOTA JACKSON
DJ



Grand
DINING TABLE

GRAND DINING TABLE

Description

96" w x 44" d x 30" h

Extending: 132" w x 44" d x 30" h (extended)

Straight veneer patterned top with contrasting Maple inlays. Lower stretcher bridges opposing pedestals. Polished Stainless Steel leg accents. Extending table accepts 2 18" leaves. Leaf storage box sold separately.

All wood groups available.

As shown: Lustrous High Polished Macassar Ebony; Maple inlays and Polished Stainless Feet (cover and top right).

Lustrous High Polished Gray Sycamore with Ebonized Maple inlays and Polished Stainless Feet (bottom).

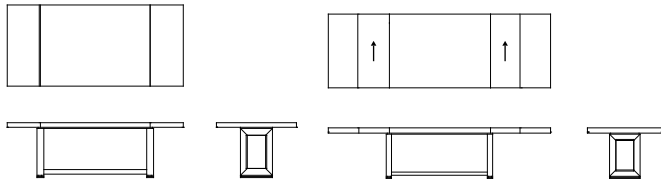

DAKOTA
JACKSON

Dakota Jackson,
Flagship Showroom
979 Third Ave #501,
New York, NY 10022
Tel. 212.838.9444
info@dakotajackson.com



*Actual color and finish may vary slightly



DAKOTA JACKSON
DJ



Grand
ROUND TABLE

GRAND ROUND TABLE

Description

42" dia. x 30.25"h, 54" dia. x 30.25"h, 60" dia. x 30.25

As Shown: Sunburst pattern top and pedestal base with contrasting insets. Polished Stainless Steel ring base detail. Polished Macassar Ebony with contrasting Satin reveals.

Available in all veneer groups.

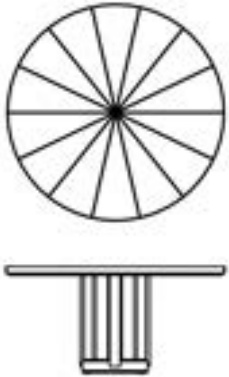

DAKOTA JACKSON

Dakota Jackson,
Flagship Showroom
979 Third Ave #501,
New York, NY 10022
Tel. 212.838.9444
info@dakotajackson.com



*Actual color and finish may vary slightly



DAKOTA JACKSON
DJ



GUI

DINING TABLE

GUI DINING TABLE

Description

96" w x 44" d x 30" h

Extending: 132" w x 44" d x 30" d (shown at right)

Table top: Arcing partial Sunburst pattern Polished Macassar Ebony veneer top with Crescent-Shaped Bentwood pedestal base and Polished Stainless Steel Buttresses. Extending table with two 18" leaves at the end. Leaf storage box sold separately.

Available in all veneer groups.

As Shown: Polished Macassar Ebony with Stainless Steel accents. (top right)

Polished Mahogany with stainless steel accents (cover and bottom)



Dining Table shown 96".

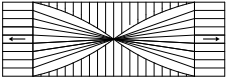
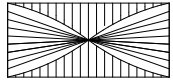

DAKOTA
JACKSON

Dakota Jackson,
Flagship Showroom
979 Third Ave #501,
New York, NY 10022
Tel. 212.838.9444
info@dakotajackson.com



*Actual color and finish may vary slightly



DAKOTA JACKSON
DJ



GUI

GLASS TOP DINING TABLE

GLASS TOP GUI DINING TABLE

Description

96"w x 44"d x 30"h

Crescent-Shaped Bentwood pedestal base is capped with Polished Stainless Steel plates. Polished Stainless Steel posts support the tempered 3/4" Tempered Glass top. With Polished Steel inset buttresses.

Available in all veneer groups.

As Shown: Polished Macassar Ebony with Stainless Steel accents.

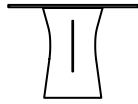
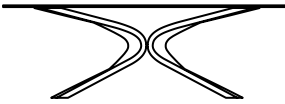
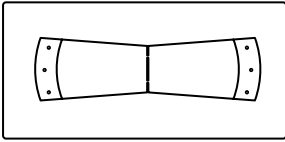

DAKOTA
JACKSON

Dakota Jackson,
Flagship Showroom
979 Third Ave #501,
New York, NY 10022
Tel. 212.838.9444
info@dakotajackson.com



*Actual color and finish may vary slightly



DAKOTA JACKSON
DJ



GUI

CONSOLE TABLE

GUI CONSOLE TABLE

Description

83"w x 21.5"d x 29.25"h

Arcing partial Sunburst pattern Polished Macassar Ebony veneer top with Crescent-Shaped Bentwood pedestal base and Polished Stainless Steel Buttresses.

All wood groups available.

As Shown: Polished Macassar Ebony with Stainless Steel accents.

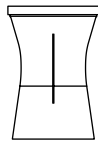
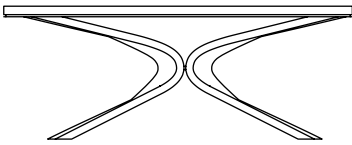
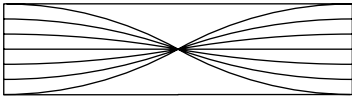

DAKOTA
JACKSON

Dakota Jackson,
Flagship Showroom
979 Third Ave #501,
New York, NY 10022
Tel. 212.838.9444
info@dakotajackson.com



DAKOTA JACKSON
DJ



Heraldic

TABLES

HERALDIC TABLES

Description

Round Table (shown right)

60" dia., 30"h

Bordered sunburst veneer pattern table top. Solid wood legs.

As Shown: Polished Polyresin Figured Anigre

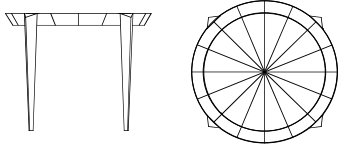

Tapered Base Table (shown bottom)

60" dia., 30"h

Bordered sunburst veneer pattern top. Bowed ends; apron bevels under. Tapered pedestal with flared base.

As Shown: Natural Mahogany

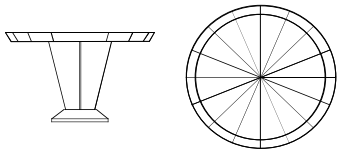

DAKOTA
JACKSON

Dakota Jackson,
Flagship Showroom
979 Third Ave #501,
New York, NY 10022
Tel. 212.838.9444
info@dakotajackson.com



DAKOTA JACKSON
DJ

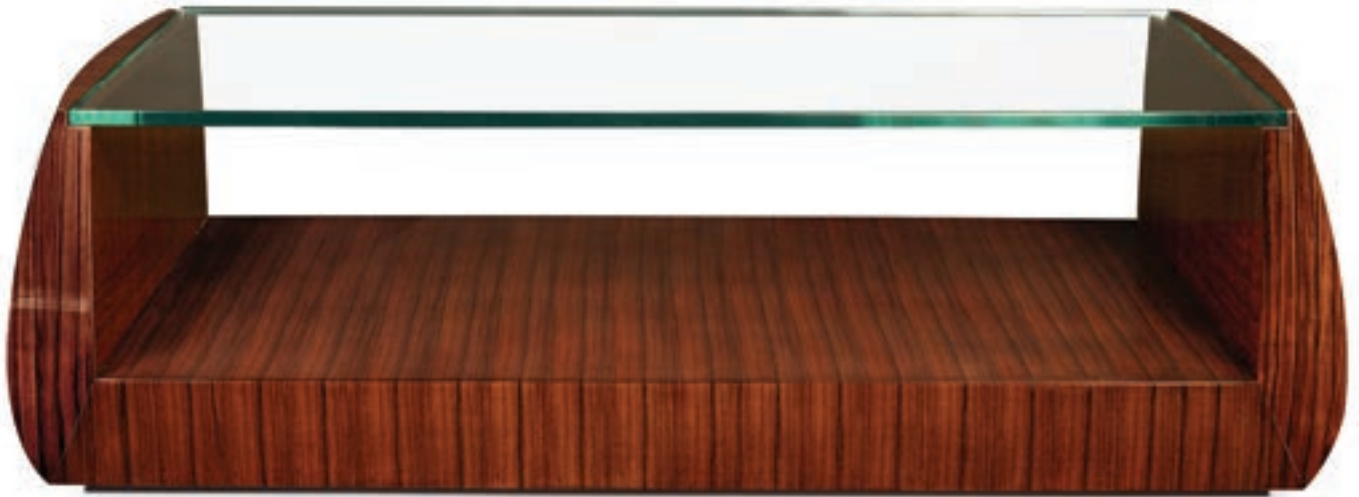

Intermezzo

COFFEE TABLE

INTERMEZZO COFFEE TABLE

Description

53.37" w x 31.25" d x 15.75" h

As Shown: High Polish Polyresin straight pattern
Rosewood veneer with Clear Float Tempered Glass
top.

Available in all veneer groups.

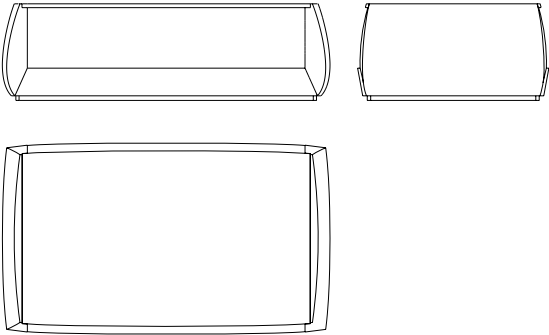

DAKOTA
JACKSON

Dakota Jackson,
Flagship Showroom
979 Third Ave #501,
New York, NY 10022
Tel. 212.838.9444
info@dakotajackson.com



*Actual color and finish may vary slightly



DAKOTA JACKSON
DJ



Marina

MARTINI CAFE TABLE

MARTINI CAFE TABLE

Description

32" dia. x 28.75"h

Polished Stainless Steel base and pedestal disc fused to 3/4" Clear Tempered Glass top. Pedestal featured both in Polished Macassar Ebony (shown at right) and Polished Sycamore (shown at bottom). Maximum tempered Glass size 36" diameter.

All veneer groups available.

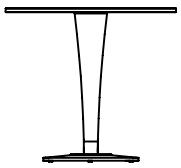
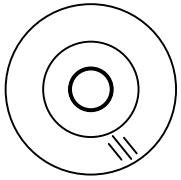

DAKOTA
JACKSON

Dakota Jackson,
Flagship Showroom
979 Third Ave #501,
New York, NY 10022
Tel. 212.838.9444
info@dakotajackson.com



*Actual color and finish may vary slightly



DAKOTA JACKSON
DJ



Marina

OCEANIA OVAL CONSOLE

OCEANIA OVAL CONSOLE

Description

80"w x 20"d x 30"h

As Shown: Polished Macassar Ebony oval pedestal with Polished Stainless Steel braces, inlays and 1/4" oval Stainless Steel cap. 3/4" Clear Float Tempered Glass top.

Available in all veneer groups.

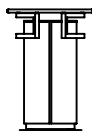
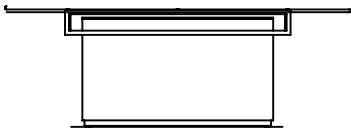
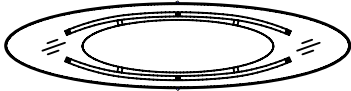

DAKOTA
JACKSON

Dakota Jackson,
Flagship Showroom
979 Third Ave #501,
New York, NY 10022
Tel. 212.838.9444
info@dakotajackson.com

*Actual color and finish may vary slightly



DAKOTA JACKSON
DJ



Marina

VISTA BREAKFAST TABLE

VISTA BREAKFAST TABLE

Description

60" diameter x 29.75"h

Polished Stainless Steel base plate and support posts. 3/4"
Clear Tempered Glass Float top fused to posts. Veneered
pedestal with Sunburst pattern recessed top detail.

All wood groups available.

As shown: Polished Macassar Ebony

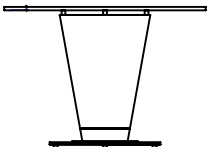
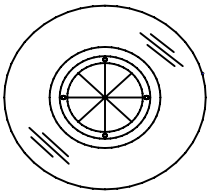

DAKOTA
JACKSON

Dakota Jackson,
Flagship Showroom
979 Third Ave #501,
New York, NY 10022
Tel. 212.838.9444
info@dakotajackson.com

*Actual color and finish may vary slightly



DAKOTA JACKSON
DJ



Marina

SCULPTURE STAND

SCULPTURE STAND

Description

15"w x 14.75"d x 36.25"h

As Shown: Polished Stainless Steel base plate, inlays and top plate. Polished Polyresin Rosewood.

Available in all veneer groups.

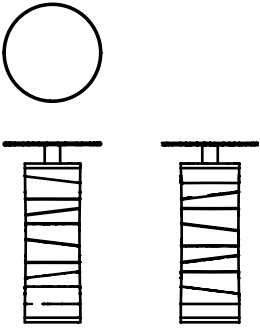

DAKOTA
JACKSON

Dakota Jackson,
Flagship Showroom
979 Third Ave #501,
New York, NY 10022
Tel. 212.838.9444
info@dakotajackson.com

*Actual color and finish may vary slightly



DAKOTA JACKSON
DJ



Maverick

DINNING TABLE

MAVERICK DINING TABLE

Description

96"w x 42"d x 30"h

Extending: 132"w x 42"d x 30"h (2 18" leaves)

As Shown: Satin Open Grain Medium Red Walnut veneer in a Demi Sunburst pattern. The lower edge of the table's apron is highlighted in a Satin Sycamore. Polished Stainless Steel trestle legs.

Leaf storage box sold separately.

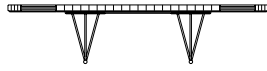
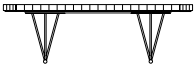
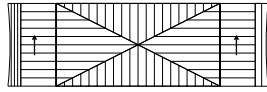
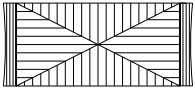

DAKOTA
JACKSON

Dakota Jackson,
Flagship Showroom
979 Third Ave #501,
New York, NY 10022
Tel. 212.838.9444
info@dakotajackson.com



DAKOTA JACKSON
DJ

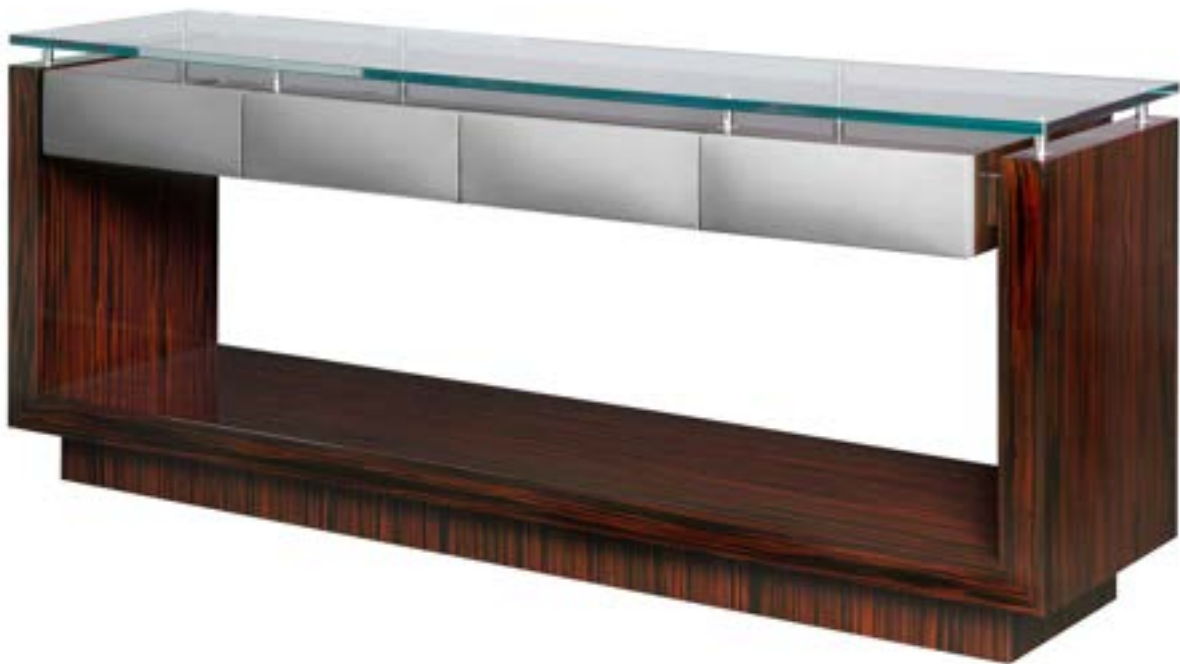

Modern
CONSOLE

MODERN CONSOLE

Description

80"w x 20.5"d x 32"h

Straight pattern veneer case. 4 domed Leather-Clad drawer faces, 3/4" clear float Tempered Glass counter top supported by Polished Stainless Steel posts. Domed surfaces are covered in premium quality selected Dakota Jackson Leathers or COL upon approval. 30 sq ft leather required.

All wood groups available.

As shown: DJL Cashmere Calf 332 Miele, Polished Polyresin Macassar Ebony.

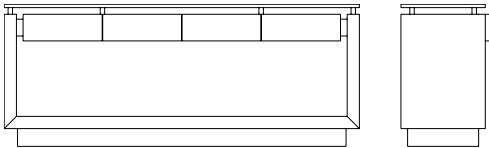

DAKOTA
JACKSON

Dakota Jackson,
Flagship Showroom
979 Third Ave #501,
New York, NY 10022
Tel. 212.838.9444
info@dakotajackson.com



*Actual color and finish may vary slightly



DAKOTA JACKSON
DJ



Modern
NIGHTSTAND

MODERN NIGHTSTAND

Description

Straight patterned veneers available in all wood groups. Domed door surfaces are covered in premium quality selected Dakota Jackson Leathers or COL upon approval.

Single Drawer Nightstand

28" w x 18" d x 23" h

Domed leather clad drawer face, 5/8" clear float Tempered Glass top surface supported by Polished Stainless Steel posts.

6 sq ft leather required

As shown: DJL Nubuck Calf, Satin-Filled Rust Makore.

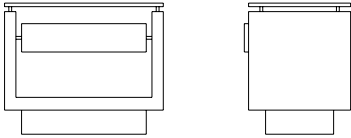

Double Door Nightstand

28" w x 18" d x 23" h

2 domed leather clad door faces, 5/8" clear float Tempered Glass top surface supported by Polished Stainless Steel posts.

12 sq ft leather required

As shown: DJL Nubuck Calf, Satin-Filled Rust Makore.

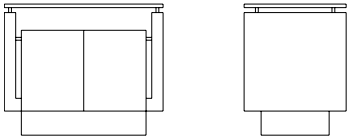

DAKOTA
JACKSON

Dakota Jackson,
Flagship Showroom
979 Third Ave #501,
New York, NY 10022
Tel. 212.838.9444
info@dakotajackson.com



DAKOTA JACKSON
DJ



Modern

BED

MODERN BED

Description

70"w x 95"d x 51"h

Upholstered Grid patterned headboard with veneer side rails and footboard. Upholstered domed headboard panels are covered in premium quality selected Dakota Jackson Leathers or COL upon approval. 90 sq ft leather required. Bed is also available in Eastern and California King size.

All wood groups available.

As shown: Satin Open Grained Rust Makore, DJL Cashmere Calf 332 Miele

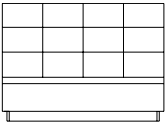

DAKOTA
JACKSON

Dakota Jackson,
Flagship Showroom
979 Third Ave #501,
New York, NY 10022
Tel. 212.838.9444
info@dakotajackson.com

*Actual color and finish may vary slightly



DAKOTA JACKSON
DJ

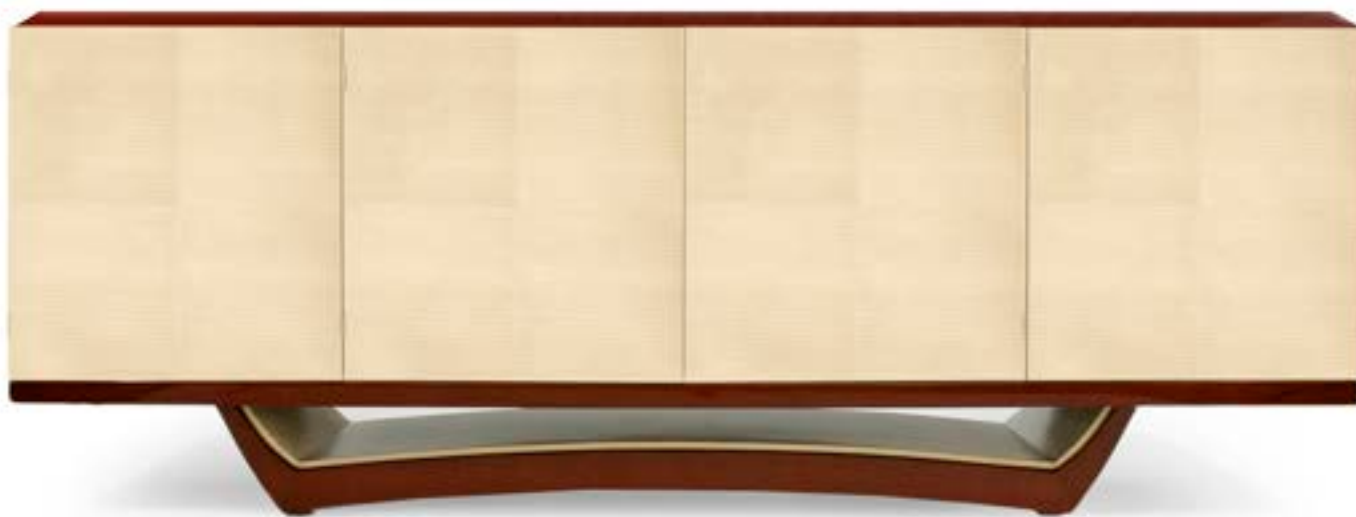

Monaco

CREDENZA

MONACO CREDENZA

Description

90"w x 22"d x 32"h

As Shown: Polished Straight Grain Makore with Matte Polyresin contrasting base and Bleached Sycamore.

Available in all veneer groups.

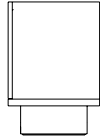
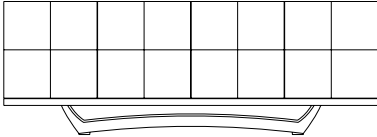

DAKOTA
JACKSON

Dakota Jackson,
Flagship Showroom
979 Third Ave #501,
New York, NY 10022
Tel. 212.838.9444
info@dakotajackson.com

*Actual color and finish may vary slightly



DAKOTA JACKSON
DJ



Monaco

DINING TABLE

MONACO DINING TABLE

Description

96"w x 44"d x 30"h

Extending: 132"w x 44"d x 30"h (shown at right)

As shown: Polished Polyresin Straight Grain Makore table apron and base faces. Matte Polyresin Sycamore table top and base. Extending table with two 18" leaves at ends. Leaf storage sold separately.

Available in all veneer groups.

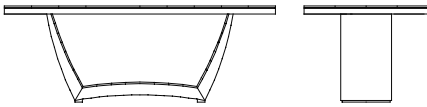
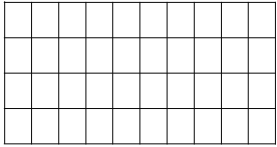

Side Elevation of Extending Dining Table in Open Position.



Table top detail.

DAKOTA
JACKSON

Dakota Jackson,
Flagship Showroom
979 Third Ave #501,
New York, NY 10022
Tel. 212.838.9444
info@dakotajackson.com



DAKOTA JACKSON
DJ



Nocturne

CREDENZA

NOCTURNE CREDENZA

Description

85"w x 19"d x 30"h

Features 4 doors with adjustable shelves or custom outfitted. Polished Polyresin Finish available in Chalk, Ruby, Azure, Aubergine and Coal. Available in all veneer groups without lattice detail.

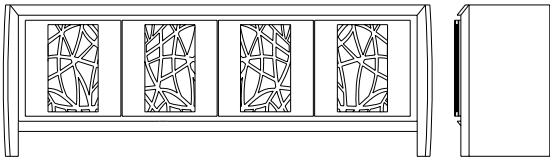

DAKOTA
JACKSON

Dakota Jackson,
Flagship Showroom
979 Third Ave #501,
New York, NY 10022
Tel. 212.838.9444
info@dakotajackson.com



*Actual color and finish may vary slightly



DAKOTA JACKSON
DJ

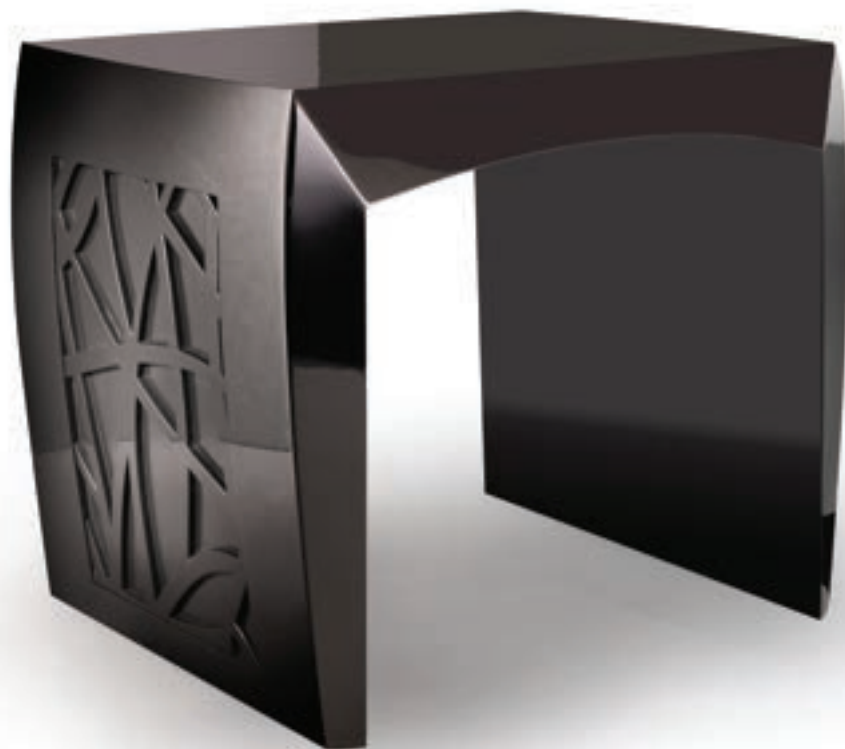

Nocturne

SIDE TABLE

NOCTURNE SIDE TABLE

Description

24"w x 21.25"d x 21"h

Polished Polyresin Finish available in Chalk, Ruby, Azure, Aubergine and Coal. Available in all veneer groups without lattice detail.

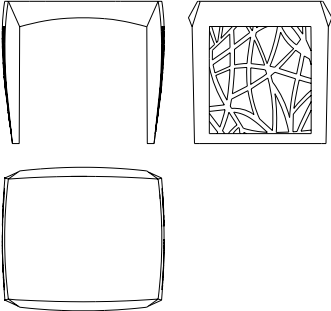

DAKOTA
JACKSON

Dakota Jackson,
Flagship Showroom
979 Third Ave #501,
New York, NY 10022
Tel. 212.838.9444
info@dakotajackson.com



*Actual color and finish may vary slightly



DAKOTA JACKSON
DJ



Nocturne

CONSOLE

NOCTURNE CONSOLE

Description

65.5"w x 21"d x 32"h

Polished Polyresin Finish available in Chalk, Ruby, Azure, Aubergine and Coal. Available in all veneer groups without lattice detail. Available with one center pencil drawer.

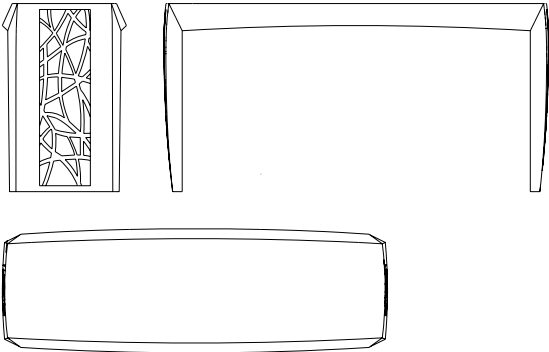

DAKOTA
JACKSON

Dakota Jackson,
Flagship Showroom
979 Third Ave #501,
New York, NY 10022
Tel. 212.838.9444
info@dakotajackson.com



DAKOTA JACKSON
DJ



Pavillion
LOW TABLE

PAVILION LOW TABLE

Description

52" w x 28" d x 14.75" h

Polished Stainless Steel open base with veneered wood top.

Standard Finishes

All veneer groups available.

Shown as: Polished Polyresin Sycamore,
Polished Stainless Steel.

DAKOTA
JACKSON

Dakota Jackson,
Flagship Showroom
979 Third Ave #501,
New York, NY 10022
Tel. 212.838.9444
info@dakotajackson.com

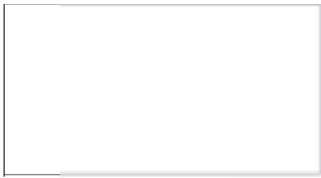

*Actual color and finish may vary slightly



DAKOTA JACKSON
DJ



Regatta
CONSOLE TABLE

REGATTA CONSOLE TABLE

Description

80"w x 20"d x 32"h

As shown: Polished Macassar Ebony, Stainless Steel pedestal base, 1/4" inset tempered Glass top. Includes 4 drawers.

Available in all veneer groups.

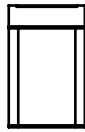
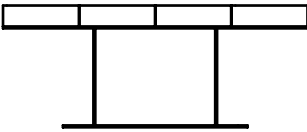
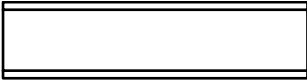

DAKOTA
JACKSON

Dakota Jackson,
Flagship Showroom
979 Third Ave #501,
New York, NY 10022
Tel. 212.838.9444
info@dakotajackson.com



*Actual color and finish may vary slightly



DAKOTA JACKSON
DJ



Regatta Suite

DINING TABLE INSET GLASS

REGATTA SUITE DINING TABLE

Description

96" w x 44" d x 30" h

Extending: 132" w x 44" d x 30" h (shown at right)

Polished Polyresin veneered tabletop, 3/4" Clear Float Tempered Glass, Solid Polished Stainless Steel pedestal base. On extending table ends pull out to allow for the insertion of a table leaf. 2 18" leaves at ends.

All wood groups available.



Side Elevation of Extending Dining Table in Open Position.

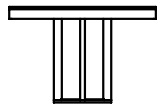
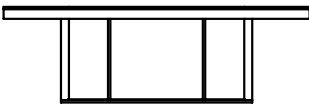
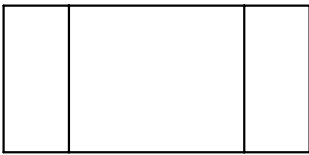

DAKOTA
JACKSON

Dakota Jackson,
Flagship Showroom
979 Third Ave #501,
New York, NY 10022
Tel. 212.838.9444
info@dakotajackson.com



*Actual color and finish may vary slightly



DAKOTA JACKSON
DJ



Regatta
DINING TABLE

REGATTA SUITE DINING TABLE

Description

96" w x 44" d x 30" h

Extending: 132" w x 44" d x 30" h (shown at right)

Polished Polyresin Finish Tabletop with Polished Stainless Steel pedestal base and apron underside cap. On extending table ends pull out to allow for the insertion of 2 18" table leaves.

All wood groups available.

As shown: Polished Elm Burl, Stainless Steel base details.



Side Elevation of Extending Dining Table in Open Position.

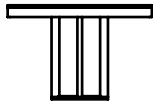
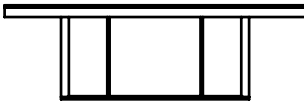

DAKOTA JACKSON
DJ



Regatta
COCKTAIL TABLE

REGATTA COCKTAIL TABLE

Description

52"w x 28"d x 15.75"h

Polished Polyresin finish with Polished Stainless Steel pedestal base and 1/2" Clear Float Tempered Glass top supported by Polished Stainless Steel posts. Open center.

Available in all veneer groups.

As shown: Polished Elm Burl, Stainless Steel details.

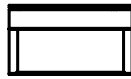
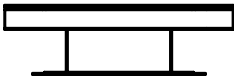
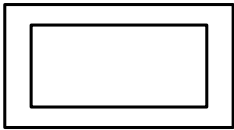

DAKOTA
JACKSON

Dakota Jackson,
Flagship Showroom
979 Third Ave #501,
New York, NY 10022
Tel. 212.838.9444
info@dakotaiackson.com



*Actual color and finish may vary slightly



DAKOTA JACKSON
DJ

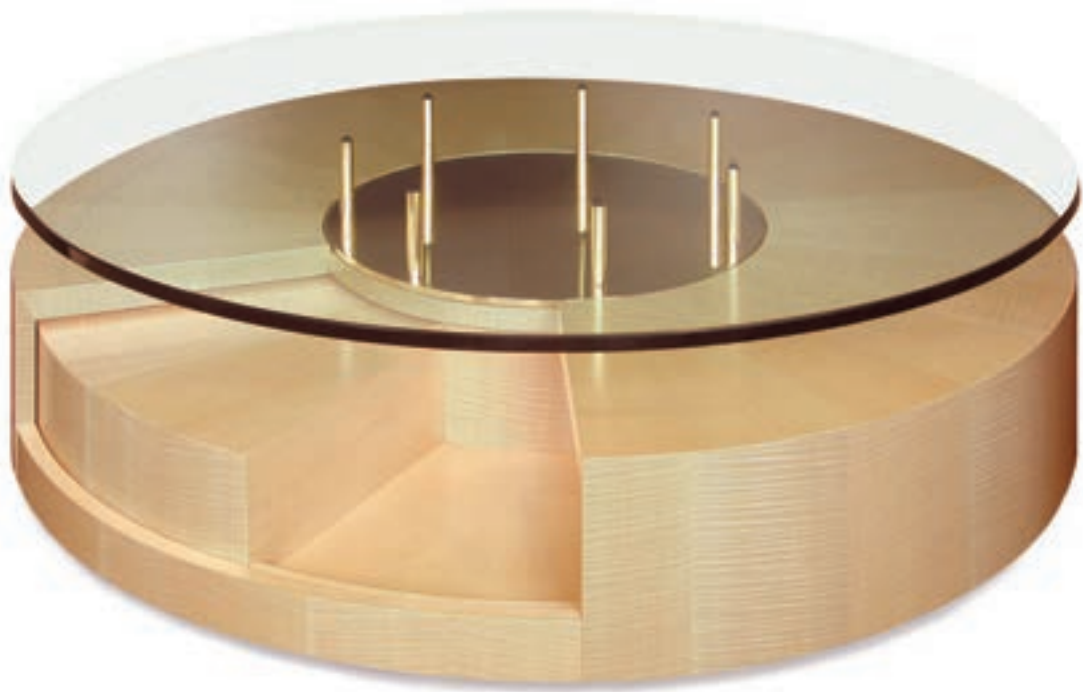

Re-wind

COCKTAIL TABLE

RE-WIND COCKTAIL TABLE

Description

52" diameter x 17" h

46" diameter x 17" h

Natural Satin Open Grain. Polished Brass or Stainless Steel, Lazy Susan tabletop support post. 3/4" Clear Float Tempered Glass top revolves as does the internal storage compartments.

As shown: Natural Satin Open Grained Sycamore with rotating Bronze finish Tempered Glass support.

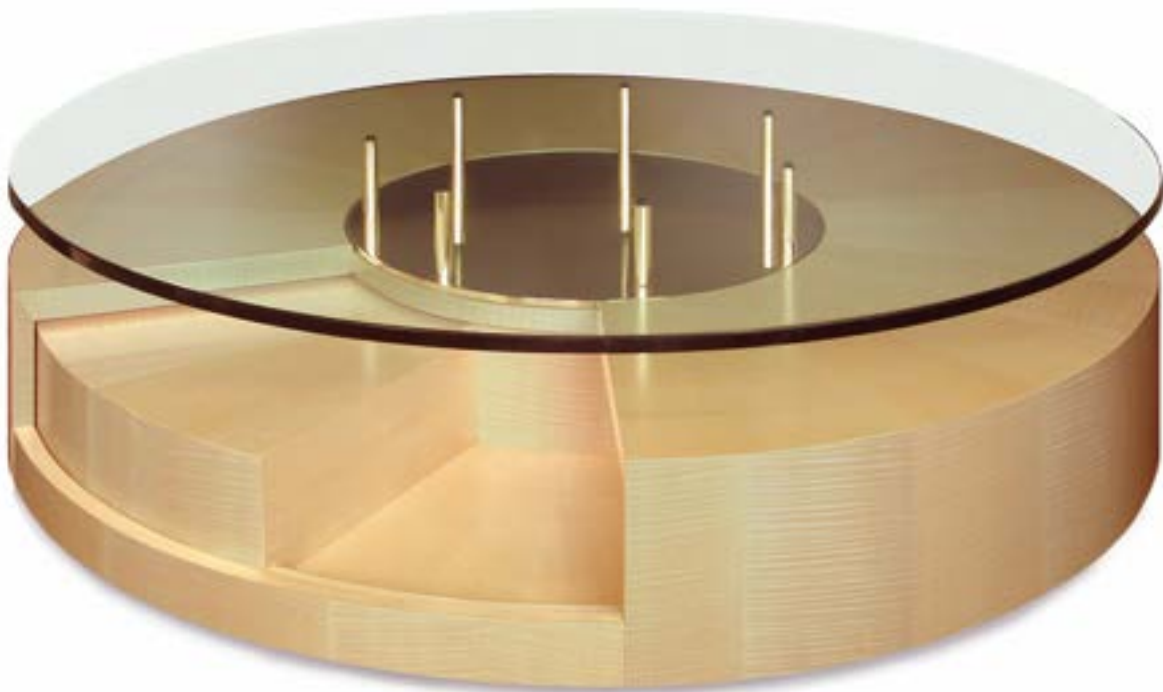
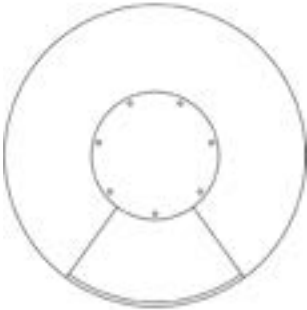
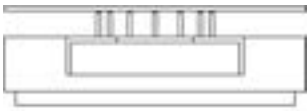

DAKOTA
JACKSON

Dakota Jackson,
Flagship Showroom
979 Third Ave #501,
New York, NY 10022
Tel. 212.838.9444
info@dakotajackson.com

*Actual color and finish may vary slightly



DAKOTA JACKSON
DJ



Self-winding

COCKTAIL TABLE

SELF-WINDING COCKTAIL TABLE

Description

36" diameter x 17" h; 48" diameter movement
44" diameter x 17" h; 62" diameter movement
48" diameter x 17" h; 65" diameter movement
54" diameter x 17" h; 72" diameter movement

Cylindrical base supporting 3 layers of 3/4" Tempered Glass. Revolving round top. Lower Tempered Glass levels revolve and extend beyond top level.

Metal Finishes

Polished Brass or Stainless Steel

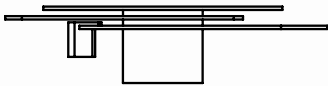
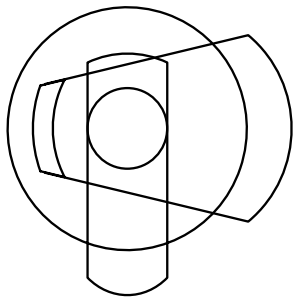
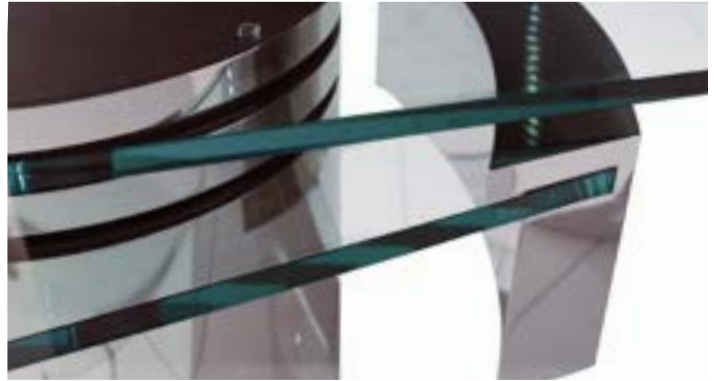

DAKOTA
JACKSON

Dakota Jackson,
Flagship Showroom
979 Third Ave #501,
New York, NY 10022
Tel. 212.838.9444
info@dakotajackson.com

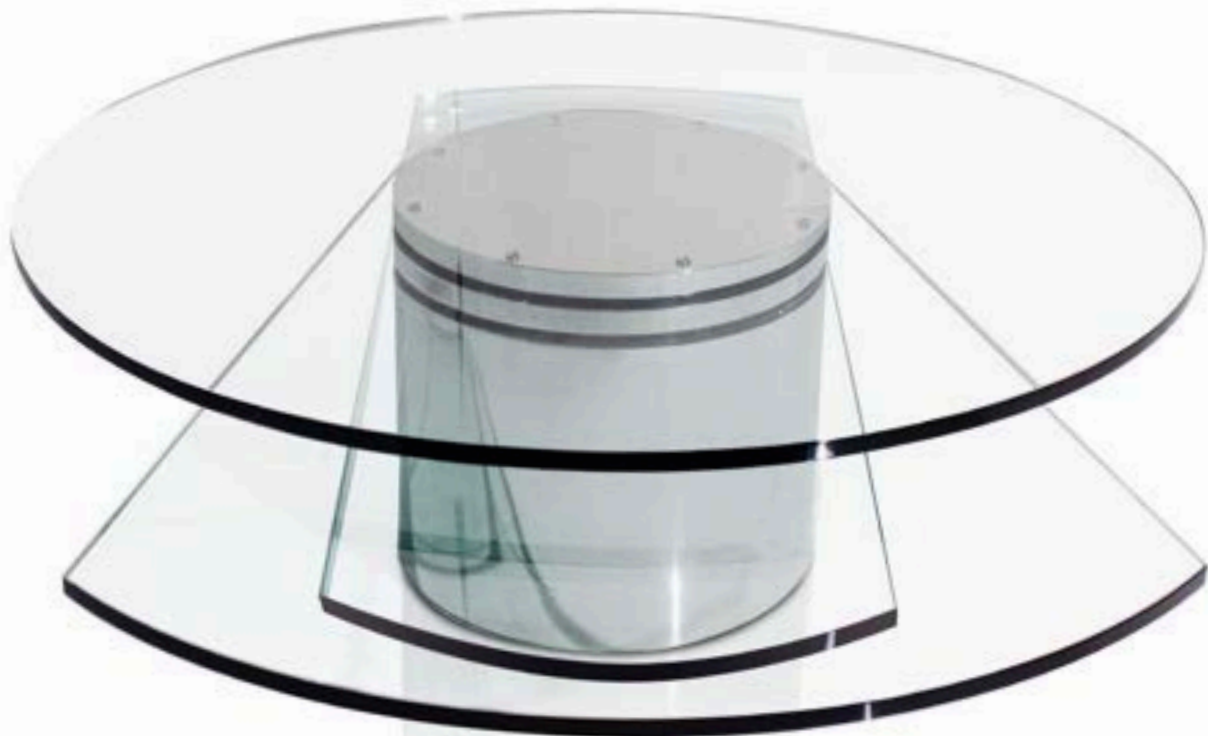

*Actual color and finish may vary slightly



DAKOTA JACKSON
DJ



Tango

DINING TABLE

TANGO DINING TABLE

Description

96"w x 42"d x 30"h, 140" ext. w

As shown: Table top is a combination of High Polished Polyresin straight pattern veneer with a Satin filled Grey Sycamore center and Brass inlays Solid Wood carved legs with Brass casters. Stationary caster cups included.

Extending Table available. Leaf storage sold separately.

Available in all veneer groups.



DAKOTA
JACKSON

Dakota Jackson,
Flagship Showroom
979 Third Ave #501,
New York, NY 10022
Tel. 212.838.9444
info@dakotajackson.com

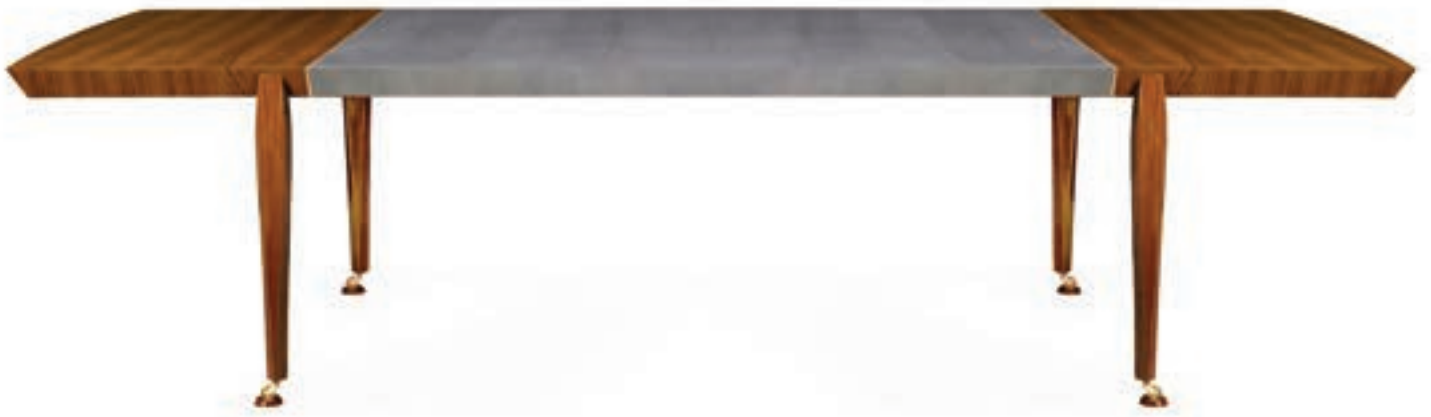
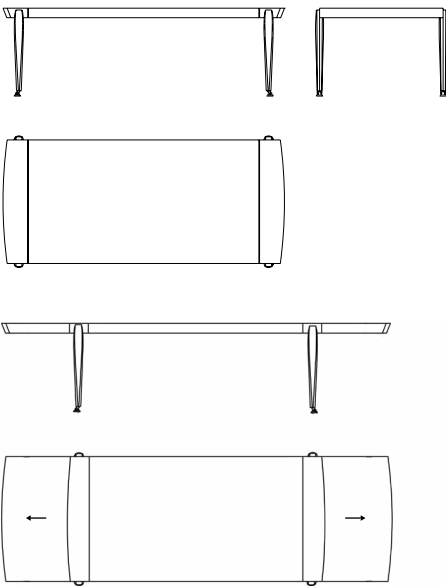

*Actual color and finish may vary slightly



DAKOTA JACKSON
DJ



Tango

GAME TABLE

TANGO GAME TABLE

Description

42"w x 42"d x 30"h

As shown: High Polish Polyresin straight pattern
Walnut veneer with Solid Walnut carved legs and
contrasting Grey Sycamore table top inset with
Brass top inlay and casters.

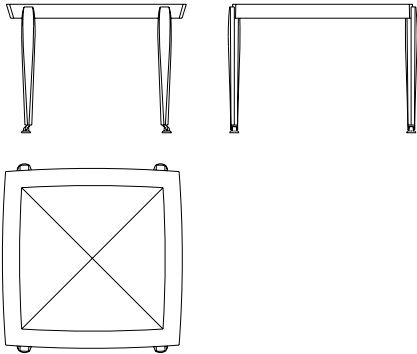

DAKOTA
JACKSON

Dakota Jackson,
Flagship Showroom
979 Third Ave #501,
New York, NY 10022
Tel. 212.838.9444
info@dakotajackson.com



*Actual color and finish may vary slightly



Occasional Pieces



DAKOTA JACKSON
DJ



Aria

OCCASIONAL TABLE

ARIA OCCASIONAL TABLE

Description

19.25"w x 19.25"d x 21"h

Polished Polyresin Finish.

Available in Chalk, Ruby, Azure, Aubergine and Coal lacquer.



As shown: Polished Polyresin Chalk (top) and Ruby (bottom).

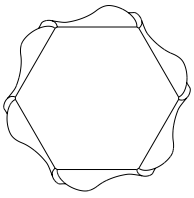
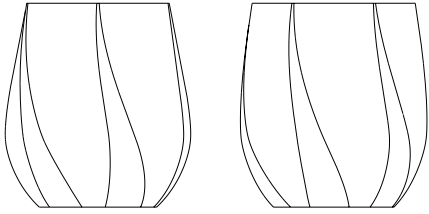

DAKOTA
JACKSON

Dakota Jackson,
Flagship Showroom
979 Third Ave #501,
New York, NY 10022
Tel. 212.838.9444
info@dakotajackson.com



*Actual color and finish may vary slightly



DAKOTA JACKSON
DJ



Chess

OCCASIONAL TABLES

CHESS OCCASIONAL TABLES

Description

24.5" x 18.5" oval x 22" h

High Lustre Poly Resin Veneer Base with High Lustre Polyresin Starburst Veneer or Lacquer Top.

All veneer groups available. Polished Lacquer in Chalk, Coal, Ruby, Azure and Aubergine.



Shown as: Polished Mahogany and Polished Anigre (bottom)
Polished Mahogany with Ruby Lacquer table top and Polished Anigre with Chalk Lacquer table top (right)

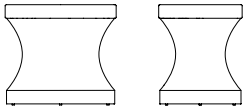
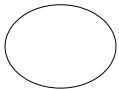
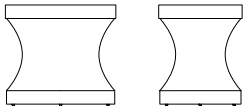
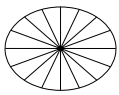

DAKOTA
JACKSON

Dakota Jackson,
Flagship Showroom
979 Third Ave #501,
New York, NY 10022
Tel. 212.838.9444
rfo@dakotajackson.com



*Actual color and finish may vary slightly



DAKOTA JACKSON
DJ



Eland

TABLES

ELAND TABLES

Description

Tapered and contoured solid wood legs, offset from mitered pattern tops (overall dimension is 2-3" larger than listed top size). All wood groups available for table top, legs in solid wood.

Round Occasional Table (shown right)

24" diameter x 24"h

As shown: Figured Anigre, Polished Polyresin Natural Mahogany legs

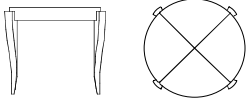

Square Occasional Table (shown front)

18"w x 18"d x 24"h; 24"w x 24"d x 24"h

As shown: Natural Satin Sycamore, Polished Polyresin Natural Mahogany legs

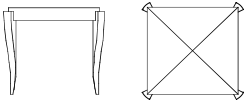

Writing Table (shown bottom)

60"w x 30"d x 29"h; 72"w x 34"d x 29"h

2 pencil drawers in apron. Available with bowed front.

As shown: Polished Polyresin Medium Tone Mahogany, Polished Polyresin Ebonized Mahogany

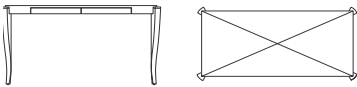

DAKOTA
JACKSON

Dakota Jackson,
Flagship Showroom
979 Third Ave #501,
New York, NY 10022
Tel. 212.838.9444
info@dakotajackson.com

*Actual color and finish may vary slightly



DAKOTA JACKSON
DJ



Grand
MIRRORS

GRAND MIRRORS

Description

Grand Round Mirror (shown at top right)

44" diameter x 3.5"d; 54" diameter x 3.5"d

As shown: Hand-Polished English Sycamore face,
banded with a Macassar Ebony frame.

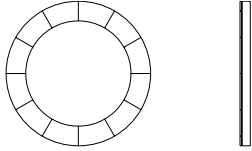

Grand Rectangular Mirror (shown at right)

42"w x 3.5"d x 52"h

As shown: Polished Macassar Ebony face, banded by a
Hand-Polished English Sycamore face.

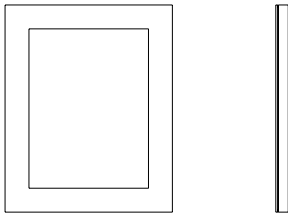

DAKOTA
JACKSON

Dakota Jackson,
Flagship Showroom
979 Third Ave #501,
New York, NY 10022
Tel. 212.838.9444
info@dakotajackson.com



DAKOTA JACKSON
DJ



Intermezzo

SIDE TABLE

INTERMEZZO SIDE TABLE

Description

26"w x 23.75"d x 20"h

High Polish Polyresin straight pattern Rosewood veneer with Clear Float Tempered Glass top.

Available in all veneer groups.

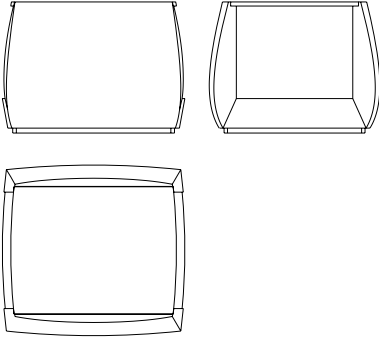

DAKOTA
JACKSON

Dakota Jackson,
Flagship Showroom
979 Third Ave #501,
New York, NY 10022
Tel. 212.838.9444
info@dakotajackson.com



*Actual color and finish may vary slightly



DAKOTA JACKSON
DJ



Marina

RIVIERA OCCASIONAL TABLE

RIVIERA OCCASIONAL TABLE

Description

24.5"w x 18"d x 22.5"h

As Shown: Satin Sycamore pedestal, Polished
Macassar Ebony top, Polished Stainless Steel base
and reveal.

Available in all veneer groups.

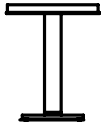
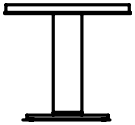

DAKOTA
JACKSON

Dakota Jackson,
Flagship Showroom
979 Third Ave #501,
New York, NY 10022
Tel. 212.838.9444
info@dakotajackson.com

*Actual color and finish may vary slightly



DAKOTA JACKSON
DJ



Marina

VISTA SIDE TABLE

VISTA SIDE TABLE

Description

20"w x 14"d x 19.5"h

Polished Stainless Steel open base and top reveal detail. 3/4" Clear Float Tempered Glass top rests on 1/8" fused metal posts.

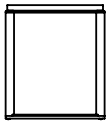
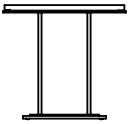
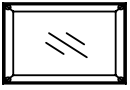

DAKOTA
JACKSON

Dakota Jackson,
Flagship Showroom
979 Third Ave #501,
New York, NY 10022
Tel. 212.838.9444
info@dakotajackson.com



*Actual color and finish may vary slightly



DAKOTA JACKSON
DJ

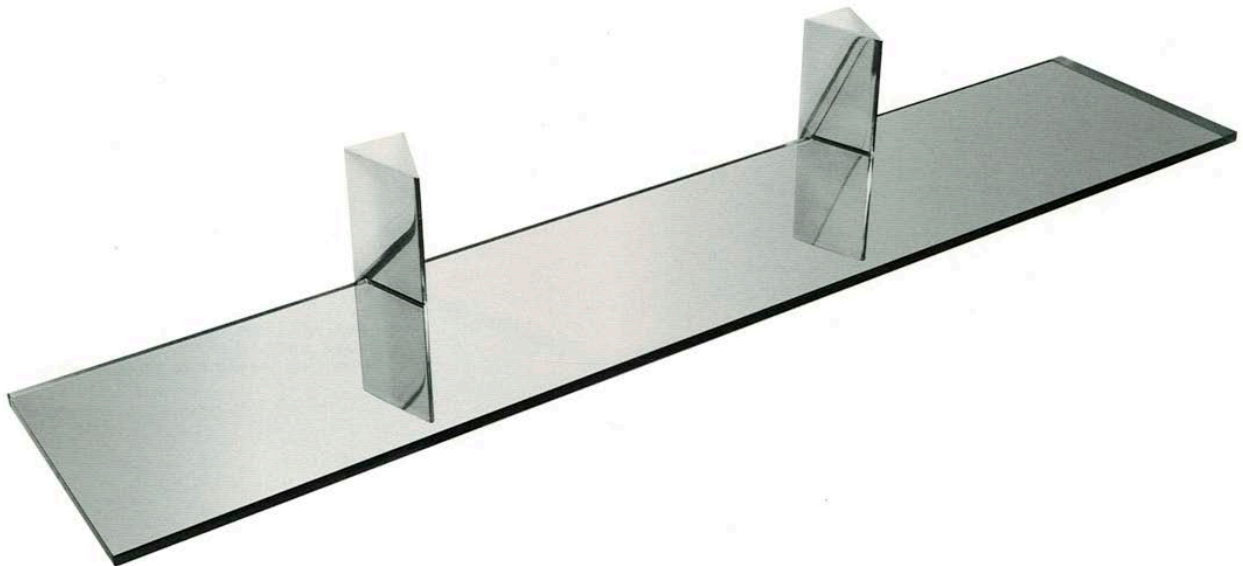

T-Bird

WALL MOUNTED BRACKETS

T-BIRD WALL MOUNTED BRACKETS

Description

4"w x 5"d x 15"h (each)

Triangular wall mounted brackets in Polished or Brushed Stainless Steel, or Brass. Accepts 3/4" Float Tempered Glass Brackets only. Sold in pairs.

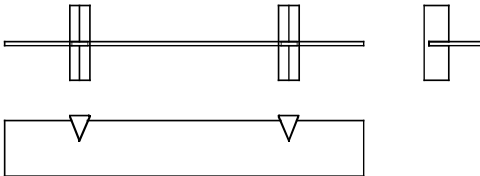

DAKOTA
JACKSON

Dakota Jackson,
Flagship Showroom
979 Third Ave #501,
New York, NY 10022
Tel. 212.838.9444
info@dakotajackson.com

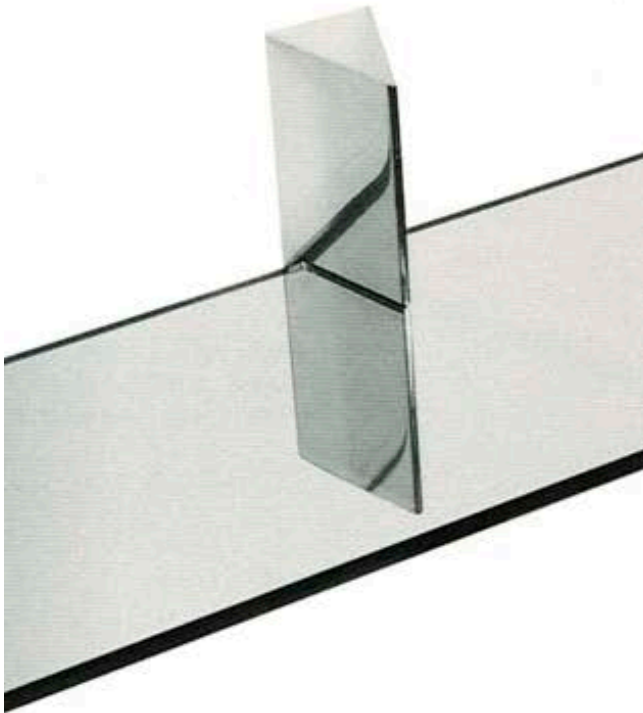

*Actual color and finish may vary slightly



Pull Up Seating



DAKOTA JACKSON
DJ



Ah!
CHAIR

AH! CHAIR

Description

Arm Chair

22.5" w x 25.75"d x 36.75"h

COM 1.75 YD

COL 25 Sq Ft

Side Chair

19" w x 25.75"d x 36.75"h

COM 1.75 YD

COL 25 Sq Ft

Kiln-dried hardwood frame. Standard Quarter cut veneered or upholstered outside back with Solid Cherry or Maple legs and steam bent arms. Fully upholstered seat and back. Available in standard wood finishes and in a full range of DJ Leathers or COM/COL upon approval. Available with or without harlequin stitch.

Standard Finishes

Cognac, Russet, Cordovan, Red Walnut, Caramel, Garnet, Espresso, Ebonized, Natural: Maple Only

Shown as: DJ Gramacy "Irish Cream" 25-17

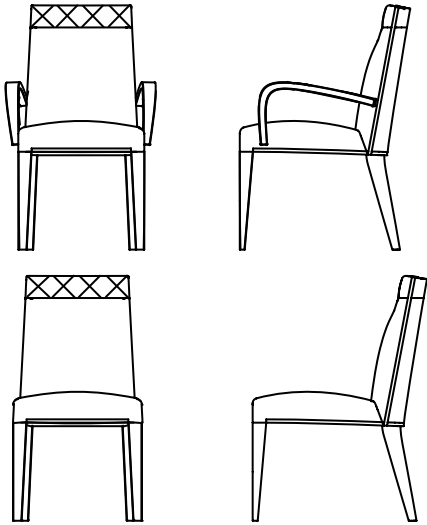

DAKOTA
JACKSON

Dakota Jackson,
Flagship Showroom
979 Third Ave #501,
New York, NY 10022
Tel. 212.838.9444
info@dakotajackson.com



Available with or without harlequin stitch detail.

*Actual color and finish may vary slightly



DAKOTA JACKSON
DJ



Aldabhra

CHAIR

ALDABHRA CHAIR

Description

Kiln-dried hardwood frame, glued, doweled, and corner-blocked. Solid Cherry or Maple legs and arms with veneered back. Inside back available with upholstered pad. Available in a full range of DJ leathers, or COM/COL upon approval.

Standard Finishes

Cognac, Russet, Cordovan, Red Walnut, Caramel, Garnet, Espresso, Ebonized, Natural in Maple only.

Arm Chair Wood Back (shown at middle right)

25" w x 25" d x 38" h; 26" arm ht; 19.75" seat ht
COM: 1 yd - 54" plain
COL: 17 sq ft leather



Arm Chair Padded Back (shown at bottom right)

25" w x 25" d x 38" h; 26" arm ht; 19.75" seat ht
COM: 1.5 yds - 54" plain
COL: 25 sq ft leather

Side Chair Wood Back (shown at front)

20" w x 25" d x 38" h; 19.75" seat ht
COM: 1 yd - 54" plain
COL: 17 sq ft leather

Side Chair Padded Back (shown at top right)

20.25" w x 25" d x 38" h; 19.625" seat ht
COM: 1.5 yds - 54" plain
COL: 25 sq ft leather



DAKOTA
JACKSON

Dakota Jackson,
Flagship Showroom
979 Third Ave #501,
New York, NY 10022
Tel. 212.838.9444
info@dakotajackson.com

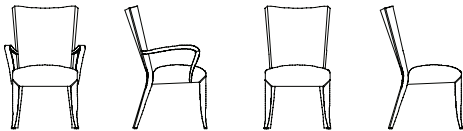

*Actual color and finish may vary slightly



DAKOTA JACKSON
DJ



Cadette

CHAIR

CADETTE CHAIR

Description

Kiln-dried hardwood frame, glued, doweled, and corner-blocked. Solid Cherry or Maple legs and arms, Satin finish. Fully-upholstered seat and back with button details or veneered inside and outside back. Available in DJ leathers, or COM/COL upon approval.

Standard Finishes

Cognac, Russet, Cordovan, Red Walnut, Caramel, Garnet, Espresso, Ebonized, Natural: Maple Only., Natural Maple Only.

Arm Chair - Wood Back (shown at bottom right)

24.375" w x 23.375" d x 36.75" h; 26.25" arm ht, 19.375" seat ht

COM: 1 yds - 54" plain

COL: 18 sq ft leather

Arm Chair - Upholstered Back (top right)

24.5" w x 24" d x 37" h; 26.25" arm ht; 19.5" seat ht

COM: 1.75 yds - 54" plain

COL: 32 sq ft leather

Side Chair - Wood Back (reverse)

24.375" w x 23.75" d x 36.875" h; 19.375" seat ht

COM: 1 yd - 54" plain

COL: 18 sq ft leather

Side Chair - Upholstered Back (middle right)

19.5" w x 23.375" d x 36.875" h; 19.375" seat ht

COM: 1.75 yds - 54" plain

COL: 32 sq ft leather



DAKOTA
JACKSON

Dakota Jackson,
Flagship Showroom
979 Third Ave #501,
New York, NY 10022
Tel. 212.838.9444
info@dakotajackson.com

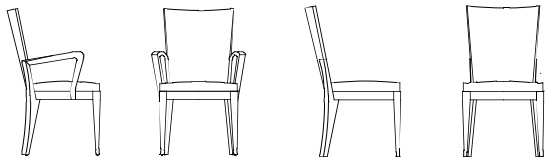

*Actual color and finish may vary slightly



DAKOTA JACKSON
DJ



Cadette²
CHAIR

CADETTE² CHAIR

Description

Kiln-dried hardwood frame, glued, doweled, and corner-blocked. Solid Cherry or Maple legs and arms, Satin finish. Fully-upholstered seat and back with cut-out detail. Available in a full range of DJ Leathers or COM/COL upon approval. Not appropriate for plaids, stripes, squares, or large patterned fabrics.

Standard Finishes

Cognac, Russet, Cordovan, Red Walnut, Caramel, Garnet, Espresso, Ebonized, Natural: Maple Only., Natural: Maple Only

Arm Chair

24.5" w x 24" d x 36.875" h; 26.25" arm ht; 19.375" seat ht
COM: 1.75" yds - 54" plain
COL: 32 sq ft leather

Side Chair

19.625" w x 23.875" d x 36.875" h; 19.375" seat ht
COM: 1.75" yds - 54" plain
COL: 32 sq ft leather

As shown: DJ Provost #2520 (Satin Garnet) on Cherry



DAKOTA
JACKSON

Dakota Jackson,
Flagship Showroom
979 Third Ave #501,
New York, NY 10022
Tel. 212.838.9444
info@dakotajackson.com

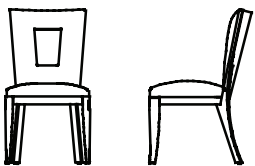
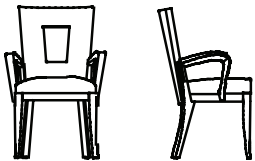

*Actual color and finish may vary slightly



DAKOTA JACKSON
DJ



Calypso
CHAIR

CALYPSO CHAIR

Description

Kiln-dried hardwood frame, glued, doweled, and corner-blocked. Solid Cherry or Maple legs and arms, and veneered back panel, Satin finish. Fully-upholstered seat and back. Available in DJ leathers, or COM/COL upon approval.

Standard Finishes

Cognac, Russet, Cordovan, Red Walnut, Caramel, Garnet, Espresso, Ebonized, Natural: Maple Only

Arm Chair

22.625" w x 24.25" d x 34.5" h; 25.75" arm ht; 20.125" seat ht

COM: 2 yds - 54" plain

COL: 36 sq ft leather

Side Chair

19.125" w x 24.25" d x 34.5" h; 20.125" seat ht

COM: 2 yds - 54" plain

COL: 36 sq ft leather

As shown: Satin Red Walnut on Cherry,
DJ King Bull #357 (Safari)



DAKOTA
JACKSON

Dakota Jackson,
Flagship Showroom
979 Third Ave #501,
New York, NY 10022
Tel. 212.838.9444
info@dakotajackson.com

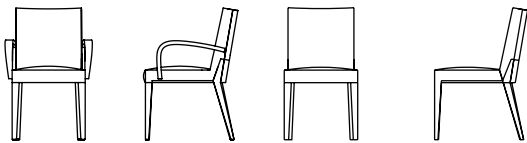

*Actual color and finish may vary slightly



DAKOTA JACKSON
DJ



Double Back
CHAIR

DOUBLE BACK CHAIR

Description

Kiln-dried hardwood frame, glued, doweled, and corner-blocked. Solid Cherry or Maple legs and veneered back, Satin finish. Fully-upholstered seat and inside back, with veneered and solid wood outsideback. Available in DJ leathers, or COM/COL upon approval.

Arm Chair

24"w x 24.25"d x 35"h; 26.25" arm ht; 18.5" seat ht
COM: 2.5 yds - 54" plain
COL: 40 sq ft leather

Side Chair

19.25"w x 24.5"d x 35"h; 18.5" seat ht
COM: 2.5 yds - 54" plain
COL: 40 sq ft leather

Standard Finishes

Cognac, Russet, Cordovan, Red Walnut, Caramel, Garnet, Espresso, Ebonized, Natural: Maple Only.

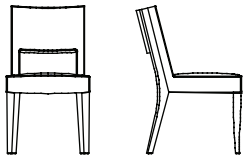
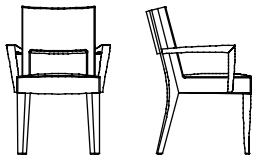

DAKOTA
JACKSON

Dakota Jackson,
Flagship Showroom
979 Third Ave #501,
New York, NY 10022
Tel. 212.838.9444
info@dakotajackson.com



DAKOTA JACKSON
DJ



IKO
CHAIR

IKO CHAIR

Description

Kiln-dried hardwood frame, glued, doweled, and corner-blocked. Solid Cherry or Maple legs. Fully-upholstered seat and back.

Arm Chair

26.75" w x 25.25" d x 35.875" h; 25.5" arm ht; 20.625" seat ht

COM: 2.75 yds - 54" plain

COL: 50 sq ft leather

Side Chair

20.875" w x 24.375" d x 35.875" h; 20.625" seat ht

COM: 2 yds - 54" plain

COL: 35 sq ft leather

Standard Finishes

Cognac, Russet, Cordovan, Red Walnut, Caramel, Garnet, Espresso, Ebonized, Natural: Maple Only.

As shown: Satin Ebonized Cherry;

Provost #0500 (Black).

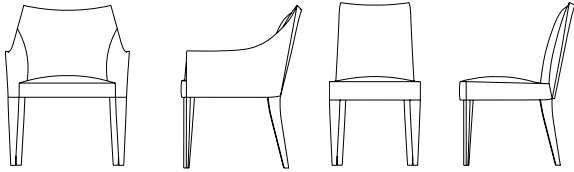

DAKOTA
JACKSON

Dakota Jackson,
Flagship Showroom
979 Third Ave #501,
New York, NY 10022
Tel. 212.838.9444
info@dakotajackson.com

*Actual color and finish may vary slightly



DAKOTA JACKSON
DJ



JiO
CHAIR

JIO CHAIR

Description

Kiln-dried hardwood frame, glued, doweled, and corner-blocked, Satin finish. Fully-upholstered "drop-in cushion" seat and back within an upholstered outer frame. Luggage stitch seam detail. Available in DJ leather, or COM/COL upon approval.

Arm Chair

24.625"w x 27.375"d x 36"h; 25.75 arm ht; 19.625" seat ht

COM: 2.5 yds - 54" plain

COL: 40 sq ft

Side Chair

21.5"w x 27.375"d x 36"h; 19.625" seat ht

COM: 2.5 yds - 54" plain

COL: 40 sq ft

Standard Finishes

Cognac, Russet, Cordovan, Red Walnut, Caramel, Garnet, Espresso, Ebonized, Natural: Maple Only.

As shown: Satin Cordovan Cherry finish,
DJ All-Grain #AG04.

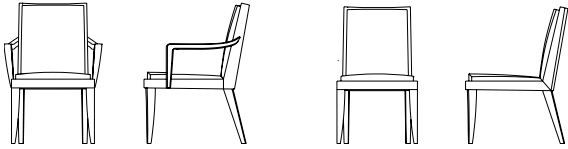

DAKOTA
JACKSON

Dakota Jackson,
Flagship Showroom
979 Third Ave #501,
New York, NY 10022
Tel. 212.838.9444
info@dakotajackson.com



*Actual color and finish may vary slightly



DAKOTA JACKSON
DJ



Ke-zu

SEATING

KE-ZU SEATING

Description

Kiln-dried hardwood frame, glued, doweled, and corner-blocked. Solid Cherry or Maple legs, Satin Open Grain finish. Fully-upholstered seat and back. Upholstered Arm Chair features luggage stitch detail. Available in DJ leather, or COM/COL upon approval. Striped fabrics are not recommended.

Standard Finishes

Cognac, Russet, Cordovan, Red Walnut, Caramel, Garnet, Espresso, Ebonized, Natural: Maple Only.

Upholstered Arm Chair

25.875" w x 27" d x 37" h; 24.5" - 25.75" arm ht; 19" seat ht

COM: 3.5 yds - 54" plain

COL: 60 sq ft leather

Side Chair

21.25" w x 27.125" d x 36.75" h; 18.75" seat ht

COM: 2 yds - 54" plain

COL: 30 sq ft leather

Bar Stool

20.375" w x 23.875" d x 43.5" h; 30.875" seat ht

COM: 2 yds - 54" plain

COL: 30 sq ft leather

Counter Stool

21" w x 23.875" d x 37.5" h; 25" seat ht

COM: 2 yds - 54" plain

COL: 30 sq ft leather

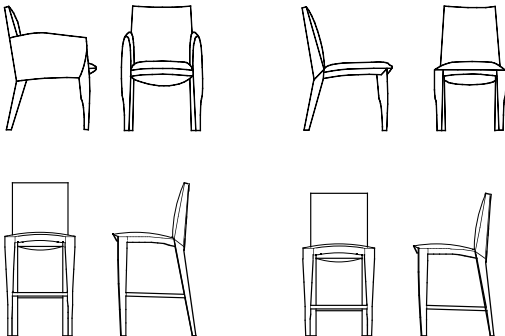

DAKOTA
JACKSON

Dakota Jackson,
Flagship Showroom
979 Third Ave #501,
New York, NY 10022
Tel. 212.838.9444
info@dakotajackson.com



*Actual color and finish may vary slightly



DAKOTA JACKSON
DJ



Marina

MONTRACHET CHAIR

MONTRACHET CHAIR

Description

19"w x 25.625"d x 35"h; 18.625" seat ht.

COM: 3 yds - 54" plain

COL: 54 sq ft leather

Kiln-dried hardwood frame, glued, doweled, and corner-blocked. Upholstered tufted seat and inside back. Laminated veneered outside back with Solid Cherry or Maple legs. Available in DJ leathers, or COM/COL upon approval. Tufting is not appropriate for all COM/COL. Non-tufted upholstery also available.

Standard Finishes

Cognac, Russet, Cordovan, Red Walnut, Caramel, Garnet, Espresso, Ebonized, Natural: Maple Only.

As shown: Macassar Ebony veneer with High Gloss Polyresin finish, Solid wood legs in a Faux Bois Macassar finish.

DAKOTA
JACKSON

Dakota Jackson,
Flagship Showroom
979 Third Ave #501,
New York, NY 10022
Tel. 212.838.9444
info@dakotajackson.com

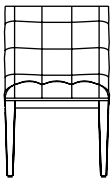
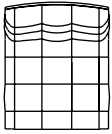

*Actual color and finish may vary slightly



DAKOTA JACKSON
DJ



Library
CHAIR

LIBRARY CHAIR

Description

A combination kiln-dried hardwood and laminated veneer faces and backs, glued, doweled, and corner-blocked. Connections are reinforced with dowels, mortise-and-tenon joints and sub-seat aprons. Each component is precision cut by a 5-axis robotic router, allowing for near 0 tolerance in alignment and fitting of all joints.

Padded chair available in DJ leathers, or COM/COL upon approval.

Standard Finishes

Maple: Natural, Cordovan, Ebonized.

Arm Chair (all wood)

24.25"w x 23.25"d x 33"h;

24 - 25.5" arm ht; 17.75" seat ht.

Padded Arm Chair (padded seat and back)

24.25"w x 23.125"d x 33.125"h

24 - 25.5" arm ht; 18.75" seat ht.

COM: 1 yd - 54" plain

COL: 25 sq ft leather

Side Chair (all wood)

20"w x 23.125"d x 33.5"h; 18.75" seat ht.

Padded Side Chair (padded seat and back)

20"w x 23.25"d x 33."h; 17.75" seat ht

COM: 1 yd - 54" plain

COL: 25 sq ft leather



DAKOTA
JACKSON

Dakota Jackson,
Flagship Showroom
979 Third Ave #501,
New York, NY 10022
Tel. 212.838.9444
info@dakotajackson.com



*Actual color and finish may vary slightly



STACKING LIBRARY CHAIR

Description

A combination kiln-dried hardwood and laminated veneer faces and backs, glued, doweled, and corner-blocked. Connections are reinforced with dowels, mortise-and-tenon joints and sub-seat aprons. Each component is precision cut by a 5-axis robotic router, allowing for near 0 tolerance in alignment and fitting of all joints. Stacking Chair stacks up to 6 high.

Padded chair available in DJ leathers, or COM/COL upon approval.

Standard Finishes

Maple: Natural, Cordovan, Ebonized.

Stacking Chair (all wood)

19.625"w x 22.5"d x 32.75"h; 17.5" seat ht.



DAKOTA JACKSON

Dakota Jackson,
Flagship Showroom
979 Third Ave #501,
New York, NY 10022
Tel. 212.838.9444
info@dakotajackson.com

*Actual color and finish may vary slightly



DAKOTA JACKSON
DJ



Luca!

DINING CHAIR

LUCA! CHAIR

Description

21.875"W x 24.875"D x 35.875"H, 18.25" seat ht.

COM: 1 yrd 54" w plain fabric

COL: 18.5 sq ft

Solid Cherry wood frame with upholstered seat.

Standard Finishes

Satin Cherry, Cognac, Russet, Cordovan, Red Walnut, Caramel, Garnet, Espresso and Ebonized.

Available in a full range of DJ leathers or COM/COL.

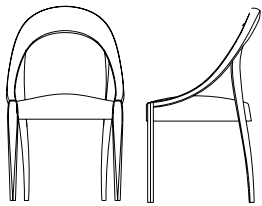

DAKOTA
JACKSON

Dakota Jackson,
Flagship Showroom
979 Third Ave #501,
New York, NY 10022
Tel. 212.838.9444
info@dakotajackson.com



*Actual color and finish may vary slightly



DAKOTA JACKSON
DJ



Ocean
CHAIR

OCEAN CHAIR

Description

Kiln-dried hardwood frame, glued, doweled, and corner-blocked. Hand-carved Cherry or Maple features with fully-upholstered seat. Available in a full range of DJ leathers, or COM/COL upon approval.

Standard Finishes

Cognac, Russet, Cordovan, Red Walnut, Caramel, Garnet, Espresso, Ebonized, Natural: Maple Only.

Arm Chair

24.5"w x 22.25"d x 34.625"h; 26.25" arm ht; 19.625"

seat ht

COM: 1 yd - 54" plain

COL: 25 sq ft leather

Side Chair

19.375"w x 22.25"d x 34.625"h; 19.625" seat ht

COM: 1 yd - 54" plain

COL: 25 sq ft leather

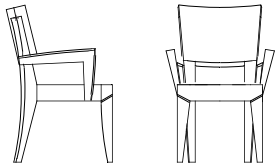
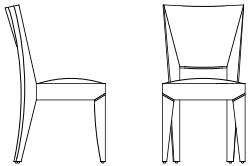

DAKOTA
JACKSON

Dakota Jackson,
Flagship Showroom
979 Third Ave #501,
New York, NY 10022
Tel. 212.838.9444
info@dakotajackson.com



DAKOTA JACKSON
DJ



Oh!
CHAIR

OH! CHAIR

Description

Arm & Side Chair

21.5" w x 25.125"d x 36.75"h

COM 1.5 YD

COL 25 Sq Ft

Kiln-dried hardwood frame. Fully upholstered seat and back with Solid Cherry or Maple legs and steam bent arms. Available in standard wood finishes and in a full range of DJ Leathers or COM/COL upon approval.

Standard Finishes

Cognac, Russet, Cordovan, Red Walnut, Caramel, Garnet, Espresso, Ebonized, Natural: Maple Only

Shown as: DJ Nubuck "Light Gray"

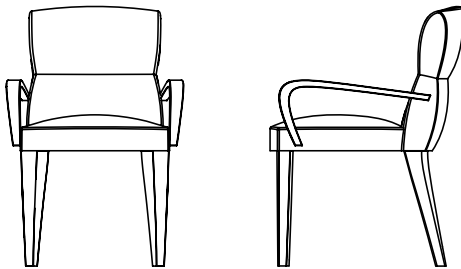
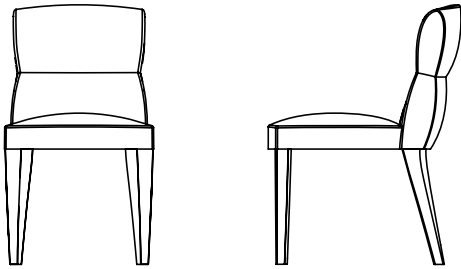

DAKOTA
JACKSON

Dakota Jackson,
Flagship Showroom
979 Third Ave #501,
New York, NY 10022
Tel. 212.838.9444
info@dakotajackson.com



DAKOTA JACKSON
DJ



Ooma
CHAIR

OOMA CHAIR

Description

Kiln-dried hardwood frame, glued, doweled, and corner-blocked. Solid Cherry or Maple legs and solid steam bent wood arms. Fully-upholstered seat and back. Available in DJ leathers, or COM/COL upon approval.

Arm Chair

23.625"w x 26.625"d x 38.25"h;

25.75" arm ht; 19.5" seat ht

COM: 2.25 yds - 54" plain

COL: 40 sq ft leather

Side Chair

20.75"w x 26.625"d x 38.25"h; 19.25" seat ht

COM: 2.25 yds - 54" plain

COL: 40 sq ft leather

Standard Finishes

Cognac, Russet, Cordovan, Red Walnut,

Caramel, Garnet, Espresso, Ebonized, Natural: Maple Only.

As shown: Garnet Cherry with Colored Polished Calf #3007



DAKOTA
JACKSON

Dakota Jackson,
Flagship Showroom
979 Third Ave #501,
New York, NY 10022
Tel. 212.838.9444
info@dakotajackson.com

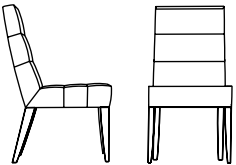
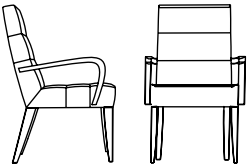

*Actual color and finish may vary slightly



DAKOTA JACKSON
DJ



PFM
CHAIR

PFM CHAIR

Description

Kiln-dried hardwood frame, glued, doweled and corner-blocked. Solid Cherry or Maple legs and seamless steam-bent domed arms in Satin finish. Fully-upholstered seat and back with welt. Available in DJ leathers, or COM/COL upon approval.

Arm Chair

25.75" w x 25.5" d x 34.25" h; 26.75" arm ht; 19.5" seat ht

COM: 2 yds - 54" plain

COL: 45 sq ft leather

Side Chair

22" w x 25.5" d x 34.25" h; 19.5" seat ht

COM: 2 yds - 54" plain

COL: 45 sq ft leather

Standard Finishes

Cognac, Russet, Cordovan, Red Walnut, Caramel, Garnet, Espresso, Ebonized, Natural: Maple Only.



DAKOTA
JACKSON

Dakota Jackson,
Flagship Showroom
979 Third Ave #501,
New York, NY 10022
Tel. 212.838.9444
info@dakotajackson.com

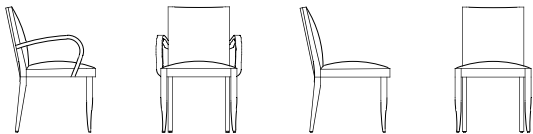

*Actual color and finish may vary slightly



DAKOTA JACKSON
DJ



PFM Royale

CHAIR

PFM ROYALE CHAIR

Description

Kiln-dried hardwood frame, glued, doweled, and corner-blocked. Solid Cherry or Maple legs, seamless steam-bent domed arms and inset Wood crown in Satin finish. Fully-upholstered seat and back with welt. Available in DJ leathers, or COM/COL upon approval.

Arm Chair

25"w x 25"d x 37.5"h; 26.5" arm ht; 19.5" seat ht

COM: 2 yds - 54" plain

COL: 45 sq ft leather

Side Chair

21.25"w x 25.75"d x 37.5"h; 19.5" seat ht

COM: 2 yds - 54" plain

COL: 45 sq ft leather

Standard Finishes

Cognac, Russet, Cordovan, Red Walnut, Caramel, Garnet, Espresso, Ebonized, Natural: Maple Only.

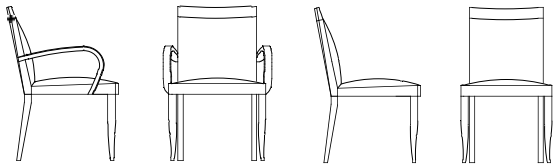

DAKOTA
JACKSON

Dakota Jackson,
Flagship Showroom
979 Third Ave #501,
New York, NY 10022
Tel. 212.838.9444
info@dakotajackson.com



*Actual color and finish may vary slightly



DAKOTA JACKSON
DJ



Puff
CHAIR

PUFF CHAIR

Description

Kiln-dried hardwood frame, glued, doweled, and corner-blocked. Solid Cherry or Maple legs and arms, Satin finish. Fully-upholstered seat and pillow back with optional tight back. Grid pattern upholstery in DJ leathers, or COM/COL upon approval.

Standard Finishes

Cognac, Russet, Cordovan, Red Walnut, Caramel, Garnet, Espresso, Ebonized, Natural: Maple Only.

Arm Chair - Pillow Back (shown on reverse)

24.25" w x 28.125" d x 38.75" h; 25.25" arm ht; 20" seat ht
COM: 2.75" yds - 54" plain
COL: 50 sq ft leather

Arm Chair - Tight Back (middle right)

24.25" w x 28.125" d x 38.75" h; 25.25" arm ht; 20" seat ht
COM: 2.25 " yds - 54" plain
COL: 40 sq ft leather

Side Chair - Pillow Back (bottom right)

20.25" w x 28.125" d x 38.75" h; 20.25" seat ht
COM: 2.75" yds - 54" plain
COL: 50 sq ft leather

Side Chair - Tight Back (top right)

20.375" w x 28.125" d x 38.75" h; 20" seat ht
COM: 2.25" yds - 54" plain
COL: 40 sq ft leather



DAKOTA
JACKSON

Dakota Jackson,
Flagship Showroom
979 Third Ave #501,
New York, NY 10022
Tel. 212.838.9444
info@dakotajackson.com

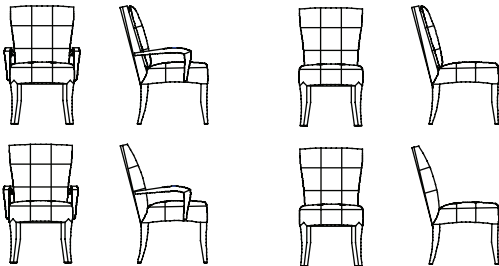

DAKOTA JACKSON
DJ



Sonata

SIDE CHAIR & ARM CHAIR

SONATA CHAIR

Description

Kiln-dried hardwood frame. Standard Quarter cut veneered outside back with Solid Cherry or Maple legs. Available in Standard wood finishes and in a full range of DJ Leathers or COM/COL upon approval.

Side Chair

20.125"w x 28.625"d x 36"h; 18.5" seat ht

COM: 2 yds - 54" plain

COL: 36 sq ft leather

Arm Chair

24"w x 28.625"d x 36"h; 18.5" seat ht

COM: 2 yds - 54" plain

COL: 36 sq ft leather

Standard Finishes

Cognac, Russet, Cordovan, Red Walnut, Caramel, Garnet, Espresso, Ebonized, Natural: Maple Only.



Shown as: DJ Sherlock "Bianco" #2650

DAKOTA
JACKSON

Dakota Jackson,
Flagship Showroom
979 Third Ave #501,
New York, NY 10022
Tel. 212.838.9444
info@dakotajackson.com

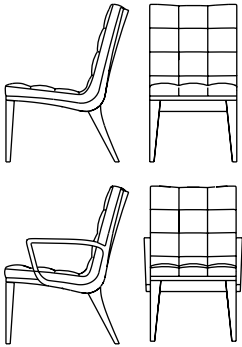

*Actual color and finish may vary slightly



Barstools



DAKOTA JACKSON
DJ



Aldabhra
STOOL

ALDABHRA STOOL

Description

Kiln-dried hardwood frame, glued, doweled, and corner-blocked. Solid Cherry or Maple legs and arms with veneered back. Fully upholstered seat. Inside back available with upholstered pad. Available in a full range of DJ leathers, or COM/COL upon approval.

Standard Finishes

Cognac, Russet, Cordovan, Red Walnut, Caramel, Garnet, Espresso, Ebonized, Natural in Maple only.

Bar Stool Wood Back

19.5"w x 22.75"d x 43"h; 29.5" seat ht

COM: 1 yd - 54" plain

COL: 17 sq ft leather

Bar Stool Padded Back

19.5"w x 22.75"d x 43"h; 29.5" seat ht

COM: 1.5 yd - 54" plain

COL: 25 sq ft leather

Counter Stool Wood Back

19.5"w x 22.75"d x 38"h; 24.5" seat ht

COM: 1 yd - 54" plain

COL: 17 sq ft leather

Counter Stool Padded Back

19.5"w x 22.75"d x 38"h; 24.5" seat ht

COM: 1.5 yd - 54" plain

COL: 27 sq ft leather

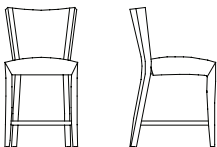
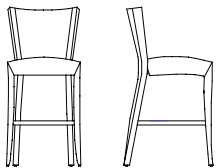

DAKOTA
JACKSON

Dakota Jackson,
Flagship Showroom
979 Third Ave #501,
New York, NY 10022
Tel. 212.838.9444
info@dakotajackson.com

*Actual color and finish may vary slightly



DAKOTA JACKSON
DJ



Cadette

BAR STOOL

CADETTE BAR STOOL

Description

Kiln-dried hardwood frame, glued, doweled, and corner-blocked. Solid Cherry or Maple legs and arms, Satin finish. Polished Stainless Steel stretchers. Fully-upholstered seat. Available with veneer inside and outside back and fully-upholstered with button detailing. Available in DJ leathers, or COM/COL upon approval. Also available as a counter stool.

Standard Finishes

Cognac, Russet, Cordovan, Red Walnut, Caramel, Garnet, Espresso, Ebonized, Natural: Maple Only., Natural: Maple Only

Wood Back Barstool

18.75"w x 20.5"d x 44.5"h; 31.5" seat ht

COM: 1 yds - 54" plain

COL: 18 sq ft leather

Upholstered Barstool

18.75"w x 20.625"d x 44.25"h; 30.25" seat ht

COM: 1.75 yds - 54" plain

COL: 32 sq ft leather

As shown: DJ Provost #2496, Satin Russet on Cherry, Polished Stainless Steel

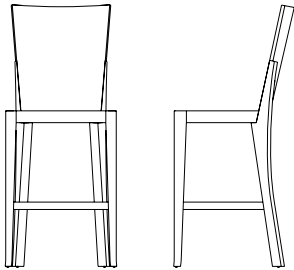

DAKOTA
JACKSON

Dakota Jackson,
Flagship Showroom
979 Third Ave #501,
New York, NY 10022
Tel. 212.838.9444
info@dakotajackson.com



DAKOTA JACKSON
DJ



Double Back

BAR STOOL

DOUBLE BACK BAR STOOL

Description

19.25"w x 23"d x 43.375"h; 28" seat ht

COM: 2.5 yards - 54" plain

COL: 40 sq ft leather

Kiln-dried hardwood frame, glued, doweled, and corner-blocked. Solid Cherry or Maple legs and veneered back, Satin finish. Polished Stainless Steel foot and stretchers. Fully-upholstered seat and inside back, with veneered and solid wood outsideback. Available in DJ leathers, or COM/COL upon approval.

Standard Finishes

Cognac, Russet, Cordovan, Red Walnut, Caramel, Garnet, Espresso, Ebonized, Natural: Maple Only.

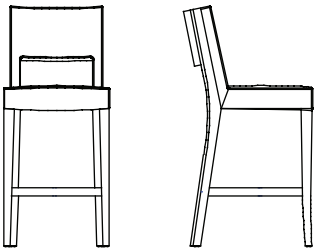

DAKOTA
JACKSON

Dakota Jackson,
Flagship Showroom
979 Third Ave #501,
New York, NY 10022
Tel. 212.838.9444
info@dakotajackson.com

*Actual color and finish may vary slightly



DAKOTA JACKSON
DJ



Ocean
STOOL

OCEAN STOOL

Description

Kiln-dried hardwood frame, glued, doweled, and corner-blocked. Solid carved seat back, solid wood legs and fully upholstered seat. Available in a full range of DJ leathers, or COM/COL upon approval.

Standard Finishes

Cognac, Russet, Cordovan, Red Walnut, Caramel, Garnet, Espresso, Ebonized, Natural: Maple Only.

Bar Stool

19.375"w x 22.25"d x 45.25"h; 30.5" seat ht

COM: 1 yd - 54" plain

COL: 25 sq ft leather

Counter Stool

19"w x 21.5"d x 40.25"h; 25.5" seat ht

COM: 1 yd - 54" plain

COL: 25 sq ft leather

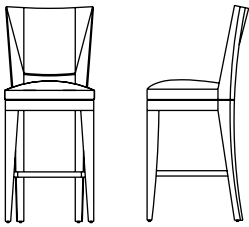

DAKOTA
JACKSON

Dakota Jackson,
Flagship Showroom
979 Third Ave #501,
New York, NY 10022
Tel. 212.838.9444
info@dakotajackson.com



DAKOTA JACKSON
DJ



Trapeze
DEMI-BACK & UNO

TRAPEZE DEMI-BACK & UNO

Description

Demi-Back (bottom)

17.25" w x 16.625" d x 39.5" h

COM 2 YD

COL 36 Sq Ft

Description

Solid Cherry or Maple Frame. Fully upholstered seat and demi-back. Stainless Double H Bar, Foot Rail and accents. All metal finishes available. Available in standard wood finishes and in a full range of DJ Leathers or COM/COL upon approval.

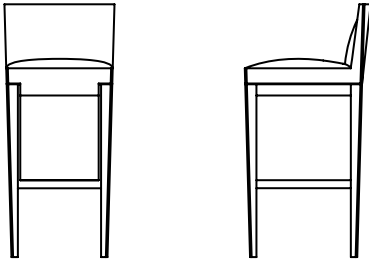

Uno (top)

16.625" w x 16.625" d x 31" h

COM 2 YD

COL 18 Sq Ft

Description

Solid Cherry or Maple Frame. Stainless Double H Bar, Foot Rail and accents. Fully upholstered seat. All metal finishes available. Available in standard wood finishes and in a full range of DJ Leathers or COM/COL upon approval.

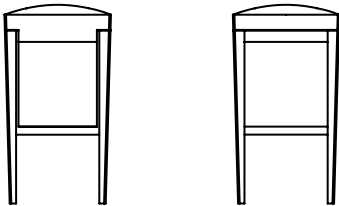

Shown as: DJ Calf "Black" 02

DAKOTA
JACKSON

Dakota Jackson,
Flagship Showroom
979 Third Ave #501,
New York, NY 10022
Tel. 212.838.9444
info@dakotajackson.com



Occasional Seating



DAKOTA JACKSON
DJ



Ceylon
LOUNGE SEATING

CEYLON LOUNGE SEATING

Description

Kiln-dried hardwood frame, glued, doweled, and corner-blocked construction with ladder back and seamless steam-bent domed arms. Satin finish. Inset, fully upholstered seat cushions, loose, reversible back cushions. Available in a full range of DJ leathers, or COM/COL upon approval.

Standard Finishes

Cognac, Russet, Cordovan, Red Walnut, Caramel, Garnet, Espresso, Ebonized, Natural: Maple Only.

Lounge Chair

30" w x 34.75" d x 34.75" h; 17.5" seat ht. 23.25" arm ht.

Armless: 25" w x 34" d x 34.75" h; 17" seat ht.

COM: 2.5 yds - 54" plain fabric

COL: 45 sq ft leather

Ottoman

25" w x 25" d x 17" h

COM: 1.5" yd - 54" plain

COL: 27 sq ft leather

Loveseat

55.5" w x 36" d x 35.5" h; 17" seat ht

Armless: 50.5" w x 36" d x 35.5" h; 17" seat ht

COM: 5 yds - 54" plain

COL: 90 sq ft leather

Sofa

80" w x 36" d x 35.5" h; 17" seat ht

Armless: 75" w x 36" d x 35.5" h; 17" seat ht

COM: 7.5 yds - 54" plain

COL: 135 sq ft leather



DAKOTA
JACKSON

Dakota Jackson,
Flagship Showroom
979 Third Ave #501,
New York, NY 10022
Tel. 212.838.9444
info@dakotajackson.com



*Actual color and finish may vary slightly



DAKOTA JACKSON
DJ



Checkerboard
CHAIR

CHECKERBOARD CHAIR

Description

28.5" w x 25" d x 27.25" h; 18" seat ht.

COM 5.5 YD

COL 82 Sq Ft

Fully upholstered tufted cube chair with Polished Stainless Steel legs. Checkerboard inspired design. Available in standard wood finishes and in a full range of DJ Leathers or COM/COL upon approval.

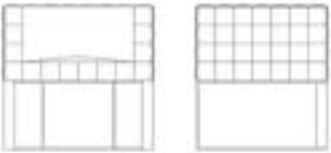

Shown as: DJ Gallery "Fumo" #2650

DAKOTA JACKSON

Dakota Jackson,
Flagship Showroom
979 Third Ave #501,
New York, NY 10022
Tel. 212.838.9444
info@dakotajackson.com



Shown as: DJ Calf "Cream" #199

*Actual color and finish may vary slightly



DAKOTA JACKSON
DJ



Marina

MARTINI BENCH

MARTINI BENCH

Description

63"w x 15.5"d x 18"h

COM: 3 yds - 54" plain; COL: 60 sq ft leather

Solid wood Cherry legs, Polished Stainless Steel frame and sabots. Fully-upholstered tufted seat. Available in a full range of Dakota Jackson leathers or COM/COL upon approval.

Standard Finishes

Cognac, Russet, Cordovan, Red Walnut, Caramel, Garnet, Espresso, Ebonized.

As Shown: Faux Bois Macassar on Cherry.
DJ Gramercy #330 (Paprika), tufted.

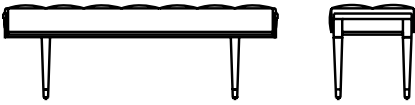

DAKOTA
JACKSON

Dakota Jackson,
Flagship Showroom
979 Third Ave #501,
New York, NY 10022
Tel. 212.838.9444
info@dakotajackson.com



*Actual color and finish may vary slightly



DAKOTA JACKSON
DJ



Marina

MARTINI LOUNGE CHAIR

MARTINI LOUNGE CHAIR

Description

29" w x 26.125" d x 28.5" h; 18" seat ht

COM: 2.5 yds - 54" plain

COL: 45 sq ft leather

Curved laminated veneered back and solid Cherry or Maple legs. Polished or Satin Stainless Steel seat back support. Fully-upholstered seat and padded back. Available in a full range of Dakota Jackson leathers, or COM/ COL upon approval.

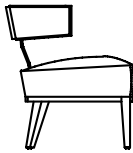
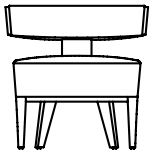
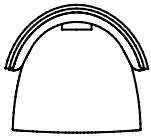

DAKOTA
JACKSON

Dakota Jackson,
Flagship Showroom
979 Third Ave #501,
New York, NY 10022
Tel. 212.838.9444
info@dakotajackson.com



*Actual color and finish may vary slightly



DAKOTA JACKSON
DJ



Marina

VISTA LOUNGE + OTTOMAN

VISTA LOUNGE + OTTOMAN

Description

Lounge Chair

28.375"w x 28.375"d x 29.875"h; 16.75" seat ht

COM: 3 yds - 54" plain

COL: 60 sq ft leather

Fully-upholstered seat and back. Polished Stainless Steel legs and back supports.

Ottoman

26.5"w x 19.25"d x 15.75"h

COM: 2 yds - 54" plain

COL: 36 sq ft leather

Fully-upholstered tight cushion. Polished Stainless Steel legs.

Available in a full range of Dakota Jackson leathers, or COM/COL upon approval.

As shown: Polished Stainless Steel, DJ Sherlock #10 (Winter White).



DAKOTA
JACKSON

Dakota Jackson,
Flagship Showroom
979 Third Ave #501,
New York, NY 10022
Tel. 212.838.9444
info@dakotajackson.com

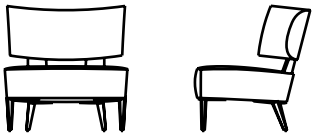

*Actual color and finish may vary slightly



DAKOTA JACKSON
DJ



Pavillion

BENCH

Description

60.125" w x 17.75" d x 17.25" h

Bent laminated veneer base, fully-upholstered seat available in a range of DJ leathers or COM/COL upon approval.

All veneer groups available.

Shown as: EV Veneer and DJ Nubuck "Light Grey"

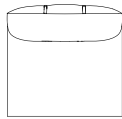
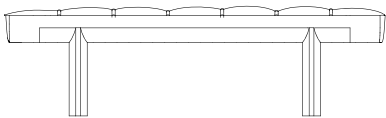

DAKOTA
JACKSON

Dakota Jackson,
Flagship Showroom
979 Third Ave #501,
New York, NY 10022
Tel. 212.838.9444
info@dakotajackson.com



DAKOTA JACKSON
DJ



Pavillion
LOUNGE SEAT

PAVILLION LOUNGE CHAIR

Description

28.25" w x 31" d x 29.5" h; 16" seat ht.

COM: 2 yds

COL: 40 sq ft

Bent laminated veneer seat/back, Stainless Steel legs fully-upholstered seat/back. Available in a full range of DJ leathers, or COM/COL upon approval.

All veneer groups available.

Shown as: EV Veneer and DJ Nubuck "Light Grey"

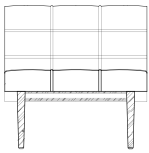

DAKOTA
JACKSON

Dakota Jackson,
Flagship Showroom
979 Third Ave #501,
New York, NY 10022
Tel. 212.838.9444
info@dakotajackson.com



DAKOTA JACKSON
DJ



Pavillion

LOVESEAT

PAVILLION LOVESEAT

Description

56.75" w x 31" d x 29.5" h; 16" seat ht.

COM: 4 yds w plain fabric

COL: 80 sq. ft

Bent laminated veneer seat/back, Stainless Steel legs
fully-upholstered seat/back. Available in a full range of DJ
leathers, or COM/COL upon approval.

All veneer groups available.

Shown as: EV Veneer and DJ Nubuck "Light Grey"

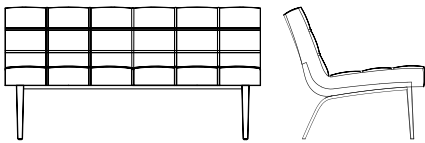

DAKOTA
JACKSON

Dakota Jackson,
Flagship Showroom
979 Third Ave #501,
New York, NY 10022
Tel. 212.838.9444
info@dakotajackson.com



*Actual color and finish may vary slightly



DAKOTA JACKSON
DJ



Ringback
CHAIR

RINGBACK CHAIR

Description

28.375" w x 26.75" d x 29.875" h

28" - 28.5" arm ht; 19.625" seat ht

COM: 4 yds - 54" plain

COL: 100 sq ft leather

Kiln-dried hardwood frame, glued, doweled, and corner-blocked. Solid Cherry or Maple legs, Satin finish. Fully-upholstered seat and back with double stitch detail. Available in a full range of Dakota Jackson leathers, or COM/COL upon approval.

Standard Finishes

Cognac, Russet, Cordovan, Red Walnut, Caramel, Garnet, Espresso, Ebonized, Natural: Maple Only.



DAKOTA
JACKSON

Dakota Jackson,
Flagship Showroom
979 Third Ave #501,
New York, NY 10022
Tel. 212.838.9444
info@dakotajackson.com

*Actual color and finish may vary slightly



DAKOTA JACKSON
DJ



Sonata
LOUNGE CHAIR

SONATA LOUNGE CHAIR

Description

28.5"w x 34.125"d x 31.125"h; 16.5" seat ht

COM: 2.75 yds - 54" plain

COL: 50 sq ft leather

Kiln-dried hardwood frame. Standard solid quarter cut veneered outside back with Solid Cherry or Maple legs. Available in standard wood finishes and in a full range of DJ Leathers or COM/COL upon approval.

Standard Finishes

Cognac, Russet, Cordovan, Red Walnut, Caramel, Garnet, Espresso, Ebonized, Natural: Maple Only.

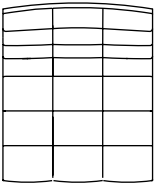
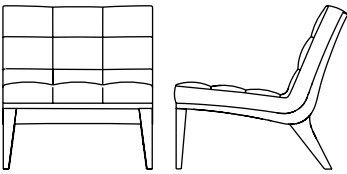

DAKOTA
JACKSON

Dakota Jackson,
Flagship Showroom
979 Third Ave #501,
New York, NY 10022
Tel. 212.838.9444
info@dakotajackson.com



*Actual color and finish may vary slightly



Fully Upholstered Seating



DAKOTA JACKSON
DJ



Allegro
LOUNGE CHAIR

ALLEGRO LOUNGE CHAIR

Description

32.75"w x 34.5"d x 28"h; 21.5" arm ht, 15.875" seat ht.

COM: 8 yds - 54" plain

COL: 145 sq ft leather

Kiln-dried hardwood frame. Fully-upholstered with down-filled loose seat and French placket style button details. Solid Cherry base in Satin finish with wood veneer reveal at back. Available in a full range of Dakota Jackson leathers, or COM/COL upon approval.

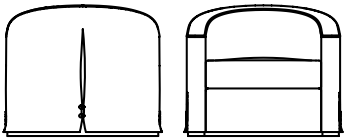

Available with swivel base.

DAKOTA
JACKSON

Dakota Jackson,
Flagship Showroom
979 Third Ave #501,
New York, NY 10022
Tel. 212.838.9444
info@dakotajackson.com



*Actual color and finish may vary slightly



DAKOTA JACKSON
DJ



Etude

SOFA

ETUDE SOFA

Description

95.75" w x 35.25" d x 30" h, 19.5" seat ht.

COM: 22.25 yds 54" w plain fabric

COL: 400 sq ft

Kiln-dried hardwood frame, glued, doweled and corner-blocked. Solid cherry hardwood apron and feet. Fully upholstered seat and back. Loose seat and back cushions with 50/50 down and feather wrap.

Available in a full range of DJ fabrics and leathers or COM/COL

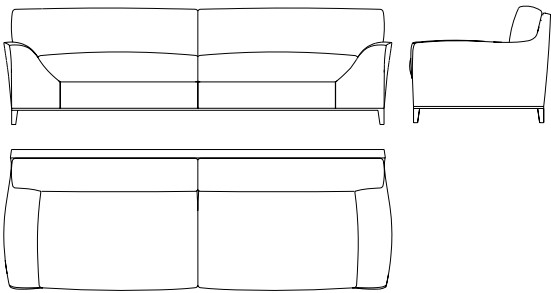

DAKOTA
JACKSON

Dakota Jackson,
Flagship Showroom
979 Third Ave #501,
New York, NY 10022
Tel. 212.838.9444
info@dakotajackson.com



*Actual color and finish may vary slightly



DAKOTA JACKSON
DJ



Etude

CLUB CHAIR

Description

40"w x 35.25"d x 30"h, 19.5" seat ht. 23.5 arm ht.

COM: 8.25 yrds

COL: 150 sq ft

Kiln-dried hardwood frame, glued, doweled and corner-blocked. Solid cherry hardwood apron and feet. Fully upholstered seat and back. Loose seat and back cushions with 50/50 down and feather wrap.

Available in a full range of DJ fabrics and leathers or COM/COL

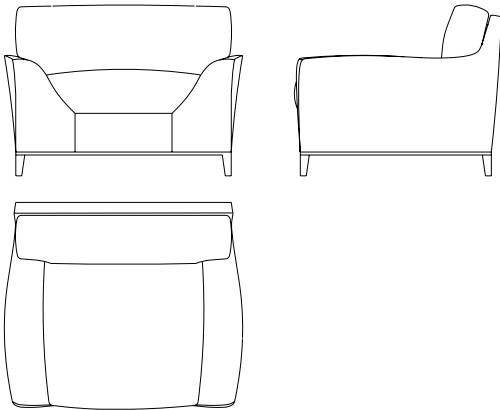

**DAKOTA
JACKSON**

Dakota Jackson,
Flagship Showroom
979 Third Ave #501,
New York, NY 10022
Tel. 212.838.9444
info@dakotajackson.com



*Actual color and finish may vary slightly



DAKOTA JACKSON
DJ



IKO Downs

SECTIONAL

IKO DOWNS SECTIONAL

Description

129.875"w x 80.875"d x 29.875"h (chaise);
37.25"d (sofa), 18.25" seat ht. 27.5 arm ht.

Leather base, leather cushions:

COM: 39 yds - 54" plain; COL: 540 sq ft leather

Leather base, fabric cushions:

COM: 22 yds - 54" plain; COL: 320 sq ft leather

Contrast throw pillows:

COM: 4 yds - 54" plain

Kiln-dried hardwood frame, glued, doweled, and corner-blocked. Polished Stainless Steel apron and Tubular feet. Fully-upholstered seat and back. Loose seat and back cushions and 4 throw pillows. Available in DJ leathers, or COM/COL upon approval.

As shown:

Polished Stainless Steel, DJ Sherlock #10 (Winter White)

Throw pillows: DJ Soho #600 (Froth)

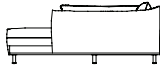
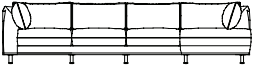
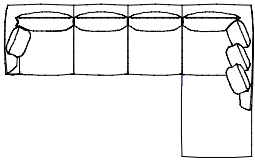

DAKOTA JACKSON

Dakota Jackson,
Flagship Showroom
979 Third Ave #501,
New York, NY 10022
Tel. 212.838.9444
info@dakotajackson.com



*Actual color and finish may vary slightly



DAKOTA JACKSON
DJ



IKO Downs

CLUB CHAIR + OTTOMAN

IKO DOWNS CLUB CHAIR + OTTOMAN

Description

Kiln-dried hardwood frame, glued, doweled, and corner-blocked. Polished Stainless Steel apron and Tubular feet. Fully-upholstered chair, seat and back. Loose seat and back cushions. Available in DJ leathers, or COM/COL upon approval.

Club Chair

37.75" w x 37.375" d x 29.875" h; 18.25" seat ht. 28" arm ht.,

Leather base, leather cushions:

COM: 8 yds - 54" plain; COL: 150 sq ft leather

Leather base, fabric cushions:

COM: 2.5 yds - 54" plain; COL: 120 sq ft leather

Ottoman

25" w x 25" d x 17" h

Fully-upholstered tight cushion. Please note ottoman height and lounge chair seat height differ.

COM: 2.5 yds - 54" plain

COL: 40 sq ft leather

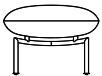
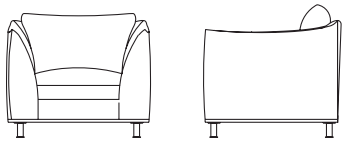

As shown:

Polished Stainless Steel, DJ Sherlock #10 (Winter White)

DAKOTA
JACKSON

Dakota Jackson,
Flagship Showroom
979 Third Ave #501,
New York, NY 10022
Tel. 212.838.9444
info@dakotajackson.com



*Actual color and finish may vary slightly



DAKOTA JACKSON
DJ



IKO Downs

SETTEE

Description

81" w x 37.375" d x 29.875" h; 18.25" seat ht.

Leather base, leather cushions:

COM: 18 yds - 54" plain; COL: 380 sq ft leather

Leather base, fabric cushions:

COM: 10 yds - 54" plain; COL: 160 sq ft leather

Kiln-dried hardwood frame, glued, doweled, and corner-blocked. Polished Stainless Steel apron and tubular feet. Fully-upholstered seat and back. Loose seat and back cushions and 2 side pillows. Available in DJ leathers, or COM/COL upon approval, or custom combination of COL arms and apron and COM seat and back cushions.

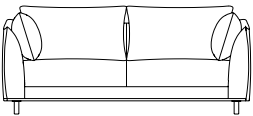
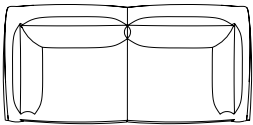

**DAKOTA
JACKSON**

Dakota Jackson,
Flagship Showroom
979 Third Ave #501,
New York, NY 10022
Tel. 212.838.9444
info@dakotajackson.com



*Actual color and finish may vary slightly



DAKOTA JACKSON
DJ



IKO Comfort

CLUB CHAIR + OTTOMAN

IKO COMFORT CLUB CHAIR + OTTOMAN

Description

Kiln-dried hardwood frame, glued, doweled, and corner-blocked.
Tight seat and back. Available in full range of DJ leathers, or COM/
COL upon approval.

As shown: DJ Essentials #3636 (Nude).

Club Chair

33.5" w x 33.875" d x 31.25" h; 18.25" seat ht. 28.25" arm ht.

COM: 7.5 yds - 54" plain

COL: 120 sq ft leather

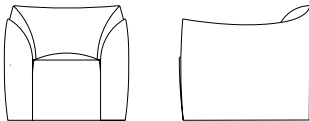

Ottoman

26" w x 26" d x 17" h

COM: 2.5 yds - 54" plain

COL: 40 sq ft leather

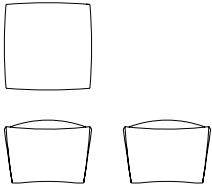

DAKOTA
JACKSON

Dakota Jackson,
Flagship Showroom
979 Third Ave #501,
New York, NY 10022
Tel. 212.838.9444
info@dakotajackson.com



*Actual color and finish may vary slightly



DAKOTA JACKSON
DJ



IKO Comfort

SOFA + SETTEE

IKO COMFORT SOFA + SETTEE

Description

Kiln-dried hardwood frame, glued, doweled, and corner-blocked.
Tight seat and back. Available in full range of DJ leathers, or COM/
COL upon approval.

As shown: DJ Essentials #3636 (Nude).

IKO Sofa

87" w x 33.875" d x 31.25" h; 18.25" seat ht. 28.25 arm ht

COM: 23 yds - 54" plain

COL: 450 sq ft leather

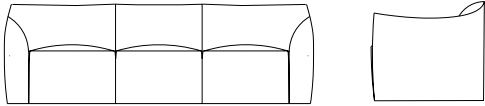

IKO Settee

70.5" w x 33.875" d x 31.25" h; 18.25" seat ht. 28.25 arm ht

COM: 19 yds - 54" plain

COL: 340 sq ft leather

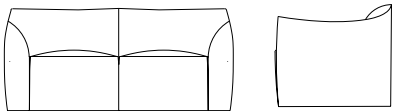

DAKOTA
JACKSON

Dakota Jackson,
Flagship Showroom
979 Third Ave #501,
New York, NY 10022
Tel. 212.838.9444
info@dakotajackson.com



*Actual color and finish may vary slightly



DAKOTA JACKSON
DJ



IKO Comfort

SECTIONAL

IKO COMFORT SECTIONAL

Description

Kiln-dried hardwood frame, glued, doweled, and corner-blocked. Tight seat and back. Available in full range of DJ leathers, or COM/COL upon approval.

As shown: DJ Essentials #3636 (Nude).

Sectional

124" w x 94.5" d x 31.25" h; 18.25" seat ht. 28.25" arm ht.

COM: 33 yds - 54" plain

COL: 580 sq ft leather

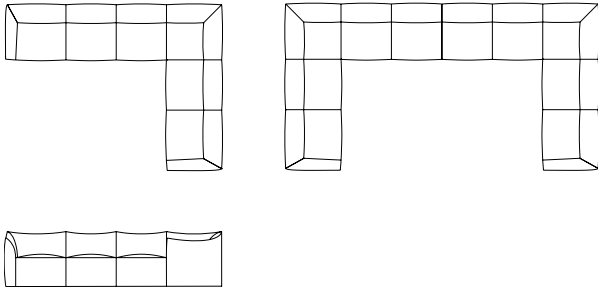

DAKOTA
JACKSON

Dakota Jackson,
Flagship Showroom
979 Third Ave #501,
New York, NY 10022
Tel. 212.838.9444
info@dakotajackson.com



*Actual color and finish may vary slightly



DAKOTA JACKSON
DJ



Interlude

SOFA

INTERLUDE SOFA

Description

108"w x 36.5"d x 31.875"h; 19.875" seat ht. 30" arm ht.

COM: 25 yds plain fabric

COL: 450 sq ft

Fully upholstered sofa with tight back and loose seat cushions (50/50 down and feather wrap). Comes with four throw pillows.

COM only upon approval.

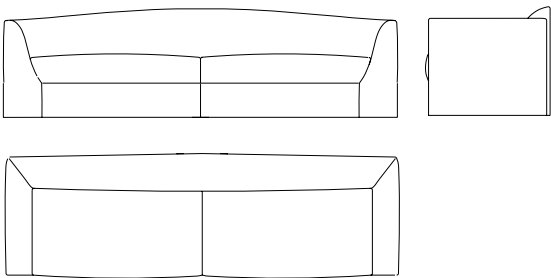

DAKOTA
JACKSON

Dakota Jackson,
Flagship Showroom
979 Third Ave #501,
New York, NY 10022
Tel. 212.838.9444
info@dakotajackson.com



*Actual color and finish may vary slightly



DAKOTA JACKSON
DJ



Interlude

CLUB CHAIR

INTERLUDE CHAIR

Description

38.5"w x 36.5"d x 32"h; 19.75" seat ht. 30" arm ht.

COM: 9.75 yds plain fabric

COL: 175 sq ft

Fully upholstered chair with tight back and loose seat cushions (50/50 down and feather wrap). Comes with a single throw pillow.

COM only upon approval.

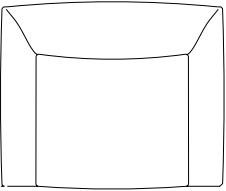
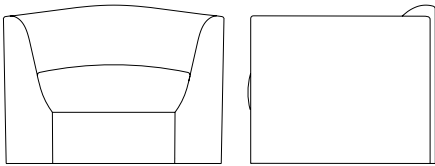

DAKOTA
JACKSON

Dakota Jackson,
Flagship Showroom
979 Third Ave #501,
New York, NY 10022
Tel. 212.838.9444
info@dakotajackson.com



*Actual color and finish may vary slightly



DAKOTA JACKSON
DJ



Ke-zu

LOUNGE SEATING

KE-ZU LOUNGE SEATING

Description

Kiln-dried hardwood frame, glued, doweled, and corner-blocked. Fully-upholstered with tight back and loose seat cushion. Available in full range of DJ leathers, or COM/COL upon approval.

Club Chair

35.5" w x 35" d x 33.5" h; 18.25" seat ht. 24.5" arm ht.
COM: 8 yds - 54" plain
COL: 150 sq ft leather

Ottoman

25" w x 25" d x 17" h
COM: 3 yds - 54" plain
COL: 50 sq ft leather

Loveseat

70.5" w x 37" d x 33.5" h; 18.25" seat ht. 24.5" arm ht.
COM: 15 yds - 54" w plain
COL: 300 sq ft leather

Sofa

86" w x 37" d x 32.75" h; 18" seat ht. 24.5" arm ht.
COM: 23 yds - 54" plain
COL: 450 sq ft leather



DAKOTA
JACKSON

Dakota Jackson,
Flagship Showroom
979 Third Ave #501,
New York, NY 10022
Tel. 212.838.9444
info@dakotajackson.com



*Actual color and finish may vary slightly



DAKOTA JACKSON
DJ



Marina

ENCORE LOUNGE CHAIR

ENCORE LOUNGE CHAIR

Description

33.5" w x 32" d x 30" h; 18" seat ht

COM: 7 yds - 54" plain

COL: 126 sq ft leather

Kiln-dried hardwood frame, glued, doweled, and corner-blocked. Solid Cherry or Maple legs, Satin finish. Fully-upholstered with loose seat and back cushions. Available in a full range of Dakota Jackson leathers, or COM/COL upon approval.

Standard Finishes

Cognac, Russet, Cordovan, Red Walnut, Caramel, Garnet, Espresso, Ebonized, Natural: Maple Only.

As shown:

Satin Cordovan on Cherry, DJ Gallery #250 (Honey).

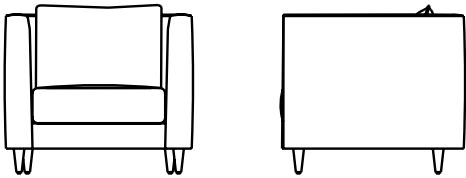

DAKOTA
JACKSON

Dakota Jackson,
Flagship Showroom
979 Third Ave #501,
New York, NY 10022
Tel. 212.838.9444
info@dakotajackson.com



*Actual color and finish may vary slightly



DAKOTA JACKSON
DJ



Marina

OCEANIA SOFA

OCEANIA SOFA

Description

90.5"w x 37"d x 29.25"h; 18" seat ht.

COM: 20 yds - 54" plain

COL: 360 sq ft leather

Throw pillows

COM: 1 yd per pillow

Kiln-dried hardwood frame, glued, doweled, and corner-blocked. Solid Cherry feet. Lose down filled seat cushions and tight back with 4 throw pillows. Available in a full range of Dakota Jackson leathers, or COM/COL upon approval.

Standard Finishes

Cognac, Russet, Cordovan, Red Walnut, Caramel, Garnet, Espresso, Ebonized, Natural: Maple Only.

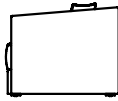
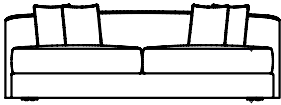

DAKOTA
JACKSON

Dakota Jackson,
Flagship Showroom
979 Third Ave #501,
New York, NY 10022
Tel. 212.838.9444
info@dakotajackson.com



*Actual color and finish may vary slightly



Executive Chairs



DAKOTA JACKSON
DJ



Ah!
EXECUTIVE CHAIR

AH! EXECUTIVE CHAIR

Description

22.75"w x 25.75"d x 36.375"h, adj. height + 2"

COM 1.75 YD

COL 25 Sq Ft

Kiln-dried hardwood frame. Standard Quarter cut veneered or upholstered outside back. Steam bent arms. Available in Standard wood finishes and in a full range of DJ Leathers or COM/COL upon approval.

Standard Caster Base: Satin Chrome caster base and cylinder, Black casters with Chrome wheel straps. Optional Caster Base: Black and Dark Bronze Powdercoat, and Wooden Caster Base Covers. Black casters option. Gas lift only available in Satin Chrome and Black

Standard Finishes

Cognac, Russet, Cordovan, Red Walnut, Caramel, Garnet, Espresso, Ebonized, Natural: Maple Only



DAKOTA JACKSON

Dakota Jackson,
Flagship Showroom
979 Third Ave #501,
New York, NY 10022
Tel. 212.838.9444
info@dakotajackson.com



Available with or without harlequin stitch detail.



Wooden Caster Base Covers available.

*Actual color and finish may vary slightly



DAKOTA JACKSON
DJ



Ke-zu

COMMANDER CHAIR

KE-ZU EXECUTIVE CHAIR

Description

25.75" w x 26.875"d x 37"h, adj. height + 2"

COM 1.5 YD

COL 25 Sq Ft

Kiln-dried hardwood frame and fully upholstered
Available in a full range of DJ Leathers or COM/COL
upon approval.

Standard Caster Base: Satin Chrome caster base
and cylinder, Black casters with Chrome wheel
straps. Optional Caster Base: Black and Dark Bronze
Powdercoat, and Wooden Caster Base Covers. Black
casters option. Gas lift only available in Satin Chrome
and Black



Wooden Caster Base Covers available.

*Actual color and finish may vary slightly



DAKOTA JACKSON
DJ



Ooma

EXECUTIVE CHAIR

OOMA EXECUTIVE CHAIR

Description

23.75"w x 26.625"d x 38.25"h; adj. height of +2"

COM: 2.25 yds - 54" plain

COL: 40 sq ft leather

Kiln-dried hardwood frame, glued, doweled, and corner-blocked. Solid Cherry arms or Maple arms, Satin finish. Adjustable-height base with tilt/swivel mechanism. Fully upholstered seat and back. Available in DJ leathers, or COM/COL upon approval.

Standard Caster Base: Satin Chrome caster base and cylinder, Black casters with Chrome wheel straps.

Optional Caster Base: Black and Dark Bronze Powdercoat. Black casters option. Gas lift only available in Satin Chrome and Black.

Standard Finishes

Cognac, Russet, Cordovan, Red Walnut,

Caramel, Garnet, Espresso, Ebonized, Natural: Maple Only.

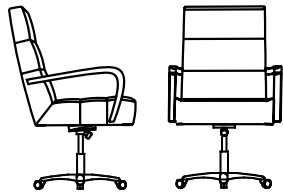

Wooden Caster Base Covers available.



DAKOTA
JACKSON

Dakota Jackson,
Flagship Showroom
979 Third Ave #501,
New York, NY 10022
Tel. 212.838.9444
info@dakotajackson.com

Shown as: DJ Gramecy "Waffles" #852

*Actual color and finish may vary slightly



DAKOTA JACKSON
DJ



Puff
EXECUTIVE CHAIR

EXECUTIVE PUFF CHAIR

Description

Kiln-dried hardwood frame, glued, doweled, and corner-blocked. Solid Cherry or Maple arms, satin finish. Adjustable height base with tilt/swivel mechanism. Fully-upholstered seat and pillow back with optional tight back. Grid pattern upholstery in DJ leathers, or COM/COL upon approval.

Standard Caster Base: Satin Chrome caster base and cylinder, Black casters with Chrome wheel straps. Optional Caster Base: Black and Dark Bronze powdercoat, and Wooden Caster Base Covers. Black casters option. Gas lift only available in Satin Chrome and Black.

Standard Finishes

Cognac, Russet, Cordovan, Red Walnut, Caramel, Garnet, Espresso, Ebonized, Natural: Maple Only.

Executive Arm Chair Pillow Back (shown at bottom)

24.25"w x 28.125"d x 38.75"h; adj. height of +2"

COM: 2.75" yds - 54" plain

COL: 50 sq ft leather

Executive Arm Chair Tight Back (shown at top)

24.25"w x 28.125"d x 38.75"h; adj. height of +2"

COM: 2.25" yds - 54" plain

COL: 40 sq ft leather

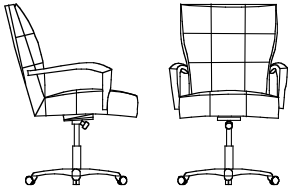

Wooden Caster Base Covers available.



DAKOTA
JACKSON

Dakota Jackson,
Flagship Showroom
979 Third Ave #501,
New York, NY 10022
Tel. 212.838.9444
info@dakotajackson.com



DAKOTA JACKSON
DJ



Sonata
EXECUTIVE CHAIR

SONATA EXECUTIVE CHAIR

Description

21" w x 25.75"d x 36.75"h, adj. height + 2"

COM 1.75 YD

COL 25 Sq Ft

Kiln-dried hardwood frame. Standard Quarter cut veneered laminated outside seat and back. Fully upholstered inside seat and back. Available in Standard wood finishes and in a full range of DJ Leathers or COM/COL upon approval.

Standard Caster Base: Satin Chrome caster base and cylinder, Black casters with Chrome wheel straps. Optional Caster Base: Black and Dark Bronze Powdercoat, and Wooden Caster Base Covers. Black casters option. Gas lift only available in Satin Chrome and Black

Standard Finishes

Cognac, Russet, Cordovan, Red Walnut, Caramel, Garnet, Espresso, Ebonized.

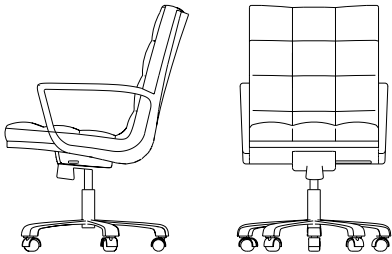

Wooden Caster Base Covers available.

DAKOTA JACKSON

Dakota Jackson,
Flagship Showroom
979 Third Ave #501,
New York, NY 10022
Tel. 212.838.9444
info@dakotajackson.com



Desks & Writing Tables



DAKOTA JACKSON
DJ



Arabesque

MARINA WRITING TABLE

ARABESQUE WRITING TABLE

Description

55"w x 24.75"d x 30.25"h

Available in Polished Sycamore with inset leather writing surface and leather drawer face. Veneered Sycamore legs and Polished Stainless Steel sabots. DJ Black Leather or Marina Grey included. Available in a select range of DJ Leather for an additional charge, or COL upon approval. COL required 18 sq ft clean desktop quality leather.

As shown: DJL Marina Grey, Polished Sycamore

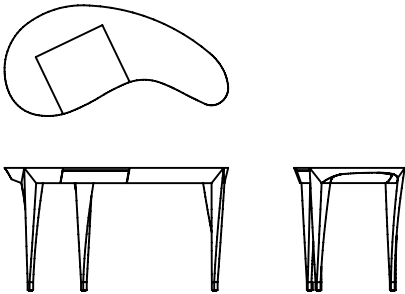

DAKOTA
JACKSON

Dakota Jackson,
Flagship Showroom
979 Third Ave #501,
New York, NY 10022
Tel. 212.838.9444
info@dakotajackson.com



*Actual color and finish may vary slightly



DAKOTA JACKSON
DJ



Bridges

DESK

BRIDGES DESK

Description

75"w x 33.75"d x 30"h

Streamlined desk with 3 drawers and inset glass top with Brass detailing.

All veneer groups available.

All metal finishes available.

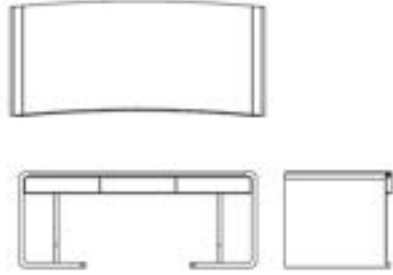

Shown as: Quarter Figured Walnut with Brass Details.

DAKOTA
JACKSON

Dakota Jackson,
Flagship Showroom
979 Third Ave #501,
New York, NY 10022
Tel. 212.838.9444
info@dakotajackson.com



DAKOTA JACKSON
DJ



Executive Suite

CHAIRMAN'S DESK

EXECUTIVE SUITE CHAIRMAN'S DESK

Description

92" w x 40.75" d x 30" h

Polished Polyresin finish , Polished Stainless Steel frame and inlay accents, 3 sliding desktop sections with storage space, and retractable Stainless Steel compartment. 1 drawer on either side. Center section slides back to reveal wire management well. DJ Chelsea Black leather writing surface or COL. Available with partial or full modesty panel.

As Shown: Polished Elm Burl with Stainless Steel accents.

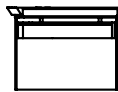
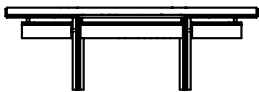
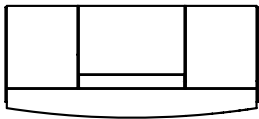

DAKOTA
JACKSON

Dakota Jackson,
Flagship Showroom
979 Third Ave #501,
New York, NY 10022
Tel. 212.838.9444
info@dakotajackson.com



*Actual color and finish may vary slightly



DAKOTA JACKSON
DJ



Executive Suite

WRITING TABLE

EXECUTIVE SUITE WRITING TABLE

Description

92"w x 40.75"d x 30"h

Elm Burl Wood with Hand-Polished Polyresin finish, Polished Stainless Steel frame and inlay accents. Center flip top for wire management. DJ Chelsea Black leather writing surface or COL. Available with partial or full modesty panel.

Available in all veneer groups.

As Shown: Polished Elm Burl with Stainless Steel accents.

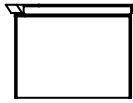
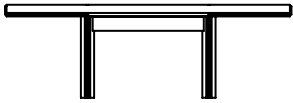
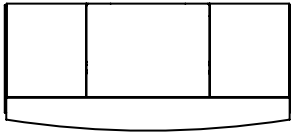

DAKOTA
JACKSON

Dakota Jackson,
Flagship Showroom
979 Third Ave #501,
New York, NY 10022
Tel. 212.838.9444
info@dakotajackson.com



*Actual color and finish may vary slightly



DAKOTA JACKSON
DJ



J-1 Cabriolet

EXECUTIVE WRITING TABLE

J-1 CABRIOLET EXECUTIVE WRITING TABLE

Description

76"w x 34"d x 30"h

Veneer laminated bent wood; 3 drawers. Inlays of Polished Stainless Steel flank the inset leather writing surface available in a select range of Dakota Jackson Leathers for an additional charge, or COL upon approval.

All wood groups available.

As shown: DJ Black Chelsea leather, Satin open grain Dark Tea Mahogany

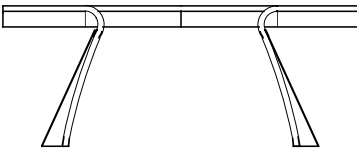

DAKOTA
JACKSON

Dakota Jackson,
Flagship Showroom
979 Third Ave #501,
New York, NY 10022
Tel. 212.838.9444
info@dakotajackson.com



*Actual color and finish may vary slightly



DAKOTA JACKSON
DJ



Maverick

WRITING DESK

MAVERICK WRITING DESK

Description

90"w x 43.75"d x 30"h

As Shown: High Polish Polyresin Medium Walnut. Satin Polyresin finishes on Sycamore drawer faces. Polished Stainless Steel trestle base.

Inset leather top available in a select range of DJ Leathers for an additional charge, or COL upon approval.

Available in all veneer groups.

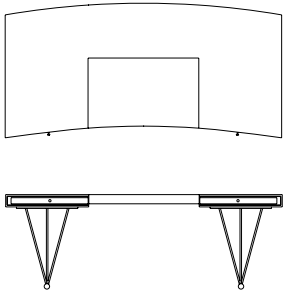

DAKOTA
JACKSON

Dakota Jackson,
Flagship Showroom
979 Third Ave #501,
New York, NY 10022
Tel. 212.838.9444
info@dakotajackson.com



*Actual color and finish may vary slightly



DAKOTA JACKSON
DJ



Maverick

CEO EXECUTIVE DESK

MAVERICK CEO EXECUTIVE DESK

Description

90"w x 40"d x 30"h (double pedestal)

As Shown: Macassar Ebony veneers with Hand Polished Polyresin finish. Polished Chalk Lacquer drawers with Polished Stainless Steel drawer pulls and pedestal legs. Leather inset in DJ Black Chelsea or COL upon approval. Available with partial or full modesty panel.

All wood groups available.

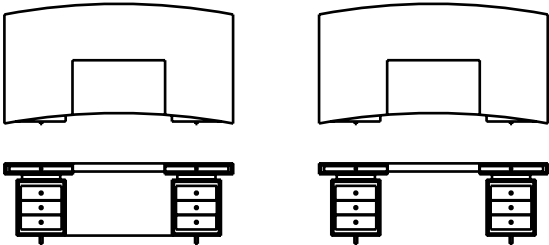

DAKOTA
JACKSON

Dakota Jackson,
Flagship Showroom
979 Third Ave #501,
New York, NY 10022
Tel. 212.838.9444
info@dakotajackson.com



*Actual color and finish may vary slightly



DAKOTA JACKSON
DJ



Nocturne

WRITING TABLE

NOCTURNE WRITING TABLE

Description

67.5"w x 31.5"d x 30"h

Features a pencil drawer. Polished Polyresin Finish available in Chalk, Ruby, Azure, Aubergine and Coal. Available in all veneer groups without lattice detail.

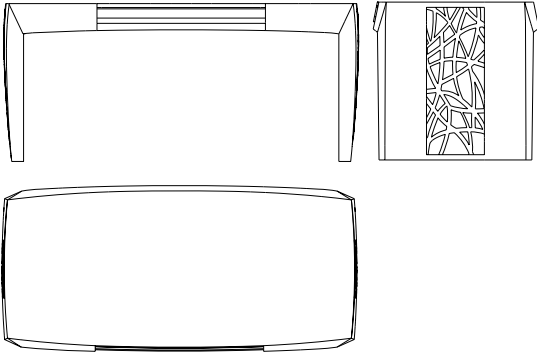

DAKOTA
JACKSON

Dakota Jackson,
Flagship Showroom
979 Third Ave #501,
New York, NY 10022
Tel. 212.838.9444
info@dakotajackson.com



*Actual color and finish may vary slightly



DAKOTA JACKSON
DJ



Nocturne

EXECUTIVE DESK

NOCTURNE EXECUTIVE DESK

Description

76"w x 31.5"d x 30"h

Features a central pencil drawer and 4 drawers.
Polished Polyresin Finish available in Chalk, Ruby, Azure, Aubergine and Coal. Available in all veneer groups without lattice detail.

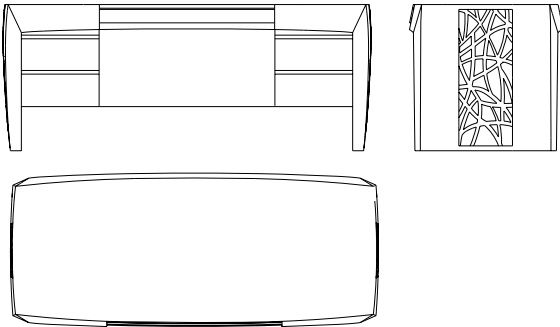

DAKOTA
JACKSON

Dakota Jackson,
Flagship Showroom
979 Third Ave #501,
New York, NY 10022
Tel. 212.838.9444
info@dakotajackson.com



*Actual color and finish may vary slightly



DAKOTA JACKSON
DJ



Partners

DESK + RETURN

PARTNERS DESK + RETURN

Description

Available in a select range of DJ Leathers for an additional charge or COL upon approval.

All wood groups available.

Desk

96" w x 42" d x 30" h

V-Shape pattern veneer top with Black Leather inset. 2 pedestal cabinets below: each with 2 standard drawers and 1 file drawer, front and back. Polished Stainless Steel drawer pulls, post, floor plates, and arced trestle supporting desktop.

As shown: DJ Chelsea Black Leather, Macassar Ebony, Polished Polyresin finish.

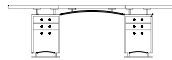
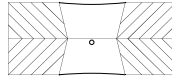

Desk with Return

90" w x 81" d x 30" h (overall); 90" w x 36" d x 30" h (desk)
48" w x 24" d x 26.5" h (return)

Single sided desk with return and full modesty panel. 2 pedestals each with 3 drawers. V-Shape pattern veneer top with Black Leather inset. Polished Stainless Steel drawer pulls, post, floor plates, and arced trestle supporting desktop.

As shown: DJ Chelsea Black Leather, Mahogany, Polished Polyresin finish.

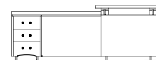
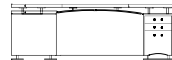
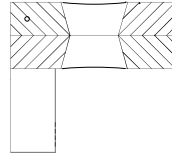

DAKOTA
JACKSON

Dakota Jackson,
Flagship Showroom
979 Third Ave #501,
New York, NY 10022
Tel. 212.838.9444
info@dakotajackson.com



*Actual color and finish may vary slightly



DAKOTA JACKSON
DJ



Washington Hall

DESK + CREDENZA

WASHINGTON HALL DESK + CREDENZA

Description

Desks featuring inset leather table top bordered by arced sides. Herringbone patterned veneer on bowed front face. Centered pencil drawer. Side drawers with bowed faces. All wood groups available. Available in a select range of DJ Leathers priced separately or COL upon approval.

Writing Table (shown at front)

78" w x 36" d x 29.5" h

3 drawers, outside drawers with bowed faces.

As shown: DJ Chelsea Black Leather, Polished Ebonized Mahogany.

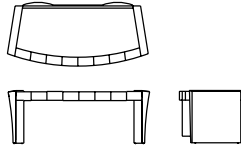

Executive Desk

90" w x 36" d x 29.5" h

2 center drawers. 2 cabinets, each with 1 standard drawer, 1 file drawer, and 1 pullout writing ledge per side. Partial or full modesty panel.

Above: Ebonized Mahogany, DJ Chelsea Black Leather
Below: Polished Macassar Ebony, DJ Chelsea Black Leather.

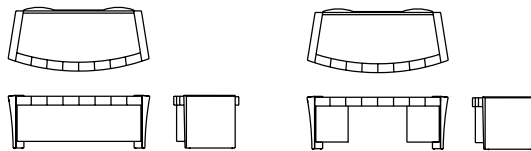

Credenza

84" w x 24" d x 32" h

Herringbone pattern veneer border. Bombe center doors and arced sides. Open grain natural Mahogany interior with adjustable shelf per section.

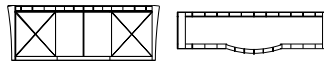

DAKOTA
JACKSON

Dakota Jackson,
Flagship Showroom
979 Third Ave #501,
New York, NY 10022
Tel. 212.838.9444
info@dakotajackson.com



*Actual color and finish may vary slightly



Pavilion



DAKOTA JACKSON
DJ



Pavillion

BENCH

Description

60.125" w x 17.75" d x 17.25" h

Bent laminated veneer base, fully-upholstered seat available in a range of DJ leathers or COM/COL upon approval.

All veneer groups available.

Shown as: EV Veneer and DJ Nubuck "Light Grey"

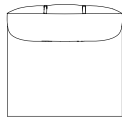
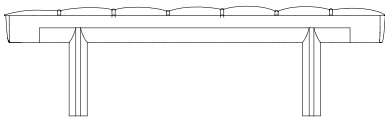

DAKOTA
JACKSON

Dakota Jackson,
Flagship Showroom
979 Third Ave #501,
New York, NY 10022
Tel. 212.838.9444
info@dakotajackson.com



DAKOTA JACKSON
DJ



Pavillion
LOUNGE SEAT

PAVILLION LOUNGE CHAIR

Description

28.25" w x 31" d x 29.5" h; 16" seat ht.

COM: 2 yds

COL: 40 sq ft

Bent laminated veneer seat/back, Stainless Steel legs fully-upholstered seat/back. Available in a full range of DJ leathers, or COM/COL upon approval.

All veneer groups available.

Shown as: EV Veneer and DJ Nubuck "Light Grey"

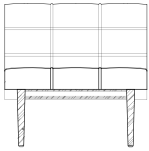

DAKOTA
JACKSON

Dakota Jackson,
Flagship Showroom
979 Third Ave #501,
New York, NY 10022
Tel. 212.838.9444
info@dakotajackson.com



DAKOTA JACKSON
DJ



Pavillion

LOVESEAT

PAVILLION LOVESEAT

Description

56.75" w x 31" d x 29.5" h; 16" seat ht.

COM: 4 yds w plain fabric

COL: 80 sq. ft

Bent laminated veneer seat/back, Stainless Steel legs
fully-upholstered seat/back. Available in a full range of DJ
leathers, or COM/COL upon approval.

All veneer groups available.

Shown as: EV Veneer and DJ Nubuck "Light Grey"

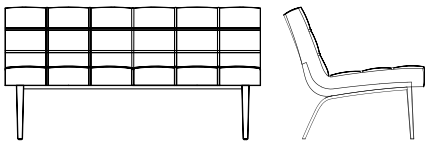

DAKOTA
JACKSON

Dakota Jackson,
Flagship Showroom
979 Third Ave #501,
New York, NY 10022
Tel. 212.838.9444
info@dakotajackson.com



*Actual color and finish may vary slightly



DAKOTA JACKSON
DJ



Pavillion
LOW TABLE

PAVILION LOW TABLE

Description

52" w x 28" d x 14.75" h

Polished Stainless Steel open base with veneered wood top.

Standard Finishes

All veneer groups available.

Shown as: Polished Polyresin Sycamore,
Polished Stainless Steel.

DAKOTA
JACKSON

Dakota Jackson,
Flagship Showroom
979 Third Ave #501,
New York, NY 10022
Tel. 212.838.9444
info@dakotajackson.com



*Actual color and finish may vary slightly



Chess



DAKOTA JACKSON
DJ



Chess
ROUND TABLE

CHESS ROUND TABLE

Description

60" dia x 30" h

54" dia. x 30" h

42" dia. x 30" h

Table top sunburst design.

Chess piece inspired base available with Garland detail.

All veneer groups available.

Shown as: Espresso Mahogany

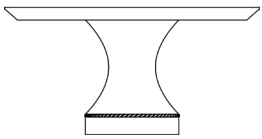
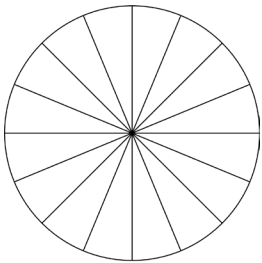

DAKOTA
JACKSON

Dakota Jackson,
Flagship Showroom
979 Third Ave #501,
New York, NY 10022
Tel. 212.838.9444
info@dakotajackson.com



*Actual color and finish may vary slightly



DAKOTA JACKSON
DJ



Chess

OVAL TABLE

CHESS OVAL DINING TABLE

Description

108" w x 48" d x 30" h

Oval Table top sunburst design.

Chess piece inspired base available with Garland detail.

All veneer groups available.

Shown as: Polished Figured Sycamore

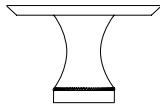
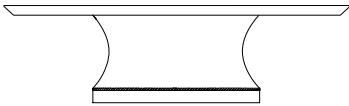
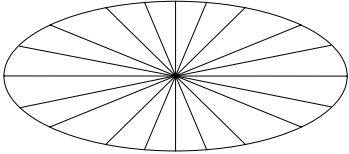

DAKOTA
JACKSON

Dakota Jackson,
Flagship Showroom
979 Third Ave #501,
New York, NY 10022
Tel. 212.838.9444
info@dakotajackson.com



*Actual color and finish may vary slightly



DAKOTA JACKSON
DJ



Chess

OVAL TABLE

CHESS OVAL DINING TABLE

Description

108" w x 48" d x 30" h

Oval Table top sunburst design.

Chess piece inspired base with Garland detail.

All veneer groups available.

Shown as: Espresso Mahogany

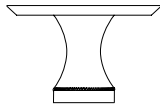
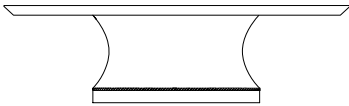
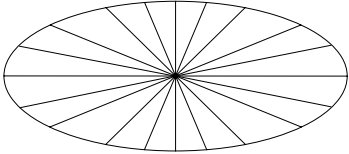

DAKOTA
JACKSON

Dakota Jackson,
Flagship Showroom
979 Third Ave #501,
New York, NY 10022
Tel. 212.838.9444
info@dakotajackson.com

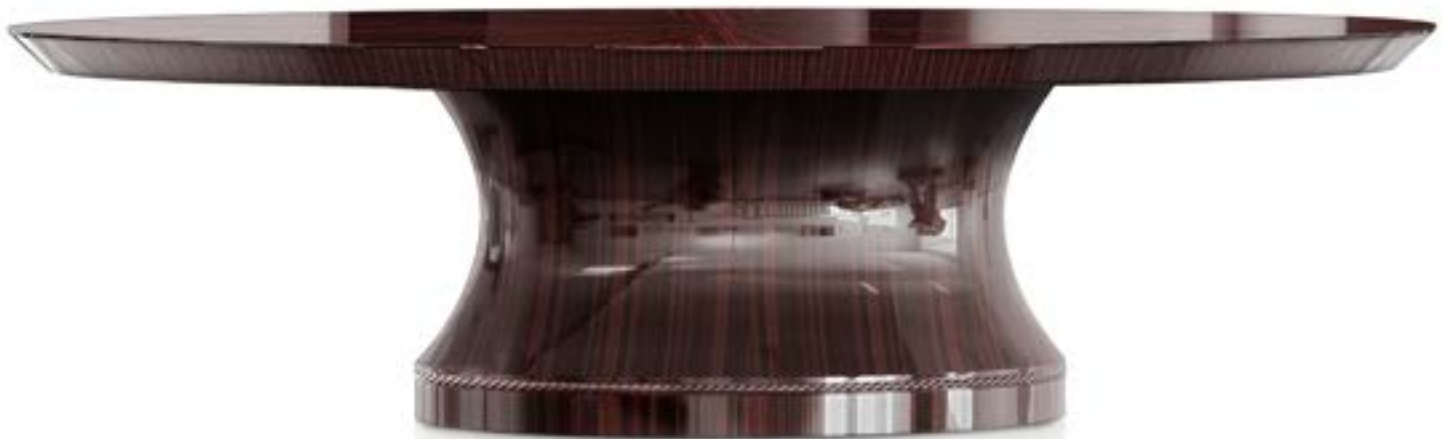

*Actual color and finish may vary slightly



DAKOTA JACKSON
DJ



Chess

DINING TABLE WITH BOWED ENDS

CHESS DINING TABLE WITH BOWED ENDS

Description

96"w x 46"d x 30"h

Extended: 132"w x 46"d x 30"h

High Lustre Poly-Resin Sunburst patterned table top with Satin finished end caps. Polished Base with inset Hand Carved Garland. Optional 18" extending Polished leaves.

All veneer groups available.

As Shown: High Lustre Rosewood Veneer

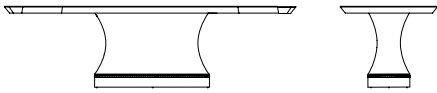
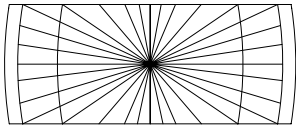

DAKOTA
JACKSON

Dakota Jackson,
Flagship Showroom
979 Third Ave #501,
New York, NY 10022
Tel. 212.838.9444
info@dakotajackson.com



*Actual color and finish may vary slightly



DAKOTA JACKSON
DJ



Checkers

CREDENZA

CHECKERS CREDENZA

Description

84" w x 22" d x 30" h

Checked Marquetry Inlay details and Stainless Steel accents. 4 drawers across the top, below 2 file drawers, 4 doors in the middle each with 1 adjustable shelf. Inset glass top.

All veneer groups available.

All metal finishes available.

Standard Finishes

Espresso Mahogany

All veneer groups available.

Shown as: Satin Walnut with Stainless Steel accents.

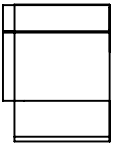
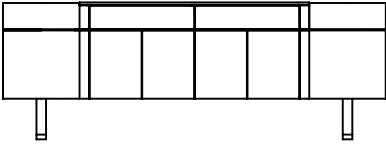

*Actual color and finish may vary slightly



DAKOTA JACKSON
DJ



Ah!
CHAIR

AH! CHAIR

Description

Arm Chair

22.5" w x 25.75"d x 36.75"h

COM 1.75 YD

COL 25 Sq Ft

Side Chair

19" w x 25.75"d x 36.75"h

COM 1.75 YD

COL 25 Sq Ft

Kiln-dried hardwood frame. Standard Quarter cut veneered or upholstered outside back with Solid Cherry or Maple legs and steam bent arms. Fully upholstered seat and back. Available in standard wood finishes and in a full range of DJ Leathers or COM/COL upon approval. Available with or without harlequin stitch.

Standard Finishes

Cognac, Russet, Cordovan, Red Walnut, Caramel, Garnet, Espresso, Ebonized, Natural: Maple Only

Shown as: DJ Gramacy "Irish Cream" 25-17

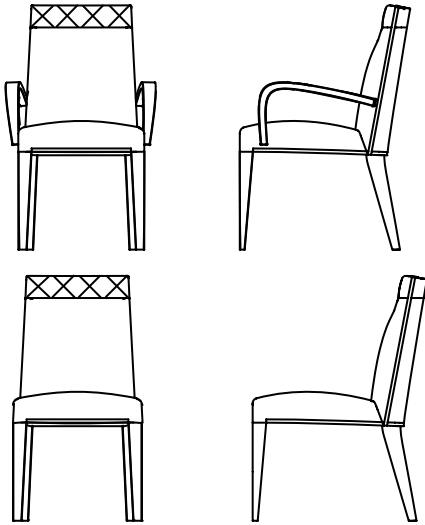

DAKOTA
JACKSON

Dakota Jackson,
Flagship Showroom
979 Third Ave #501,
New York, NY 10022
Tel. 212.838.9444
info@dakotajackson.com



Available with or without harlequin stitch detail.

*Actual color and finish may vary slightly



DAKOTA JACKSON
DJ



Ah!
EXECUTIVE CHAIR

AH! EXECUTIVE CHAIR

Description

22.75"w x 25.75"d x 36.375"h, adj. height + 2"

COM 1.75 YD

COL 25 Sq Ft

Kiln-dried hardwood frame. Standard Quarter cut veneered or upholstered outside back. Steam bent arms. Available in Standard wood finishes and in a full range of DJ Leathers or COM/COL upon approval.

Standard Caster Base: Satin Chrome caster base and cylinder, Black casters with Chrome wheel straps. Optional Caster Base: Black and Dark Bronze Powdercoat, and Wooden Caster Base Covers. Black casters option. Gas lift only available in Satin Chrome and Black

Standard Finishes

Cognac, Russet, Cordovan, Red Walnut, Caramel, Garnet, Espresso, Ebonized, Natural: Maple Only



DAKOTA
JACKSON

Dakota Jackson,
Flagship Showroom
979 Third Ave #501,
New York, NY 10022
Tel. 212.838.9444
info@dakotajackson.com



Available with or without harlequin stitch detail.



Wooden Caster Base Covers available.

*Actual color and finish may vary slightly



DAKOTA JACKSON
DJ



Oh!
CHAIR

OH! CHAIR

Description

Arm & Side Chair

21.5" w x 25.125"d x 36.75"h

COM 1.5 YD

COL 25 Sq Ft

Kiln-dried hardwood frame. Fully upholstered seat and back with Solid Cherry or Maple legs and steam bent arms. Available in standard wood finishes and in a full range of DJ Leathers or COM/COL upon approval.

Standard Finishes

Cognac, Russet, Cordovan, Red Walnut, Caramel, Garnet, Espresso, Ebonized, Natural: Maple Only

Shown as: DJ Nubuck "Light Gray"

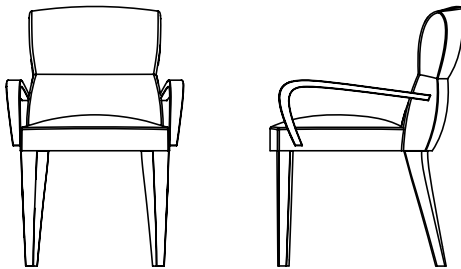
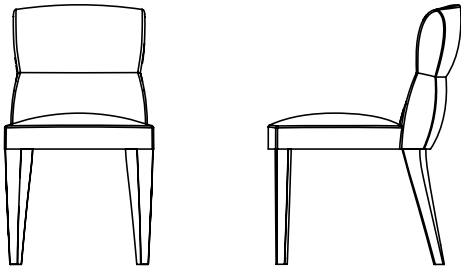

DAKOTA
JACKSON

Dakota Jackson,
Flagship Showroom
979 Third Ave #501,
New York, NY 10022
Tel. 212.838.9444
info@dakotajackson.com



DAKOTA JACKSON
DJ



Trapeze
DEMI-BACK & UNO

TRAPEZE DEMI-BACK & UNO

Description

Demi-Back (bottom)

17.25" w x 16.625" d x 39.5" h

COM 2 YD

COL 36 Sq Ft

Description

Solid Cherry or Maple Frame. Fully upholstered seat and demi-back. Stainless Double H Bar, Foot Rail and accents. All metal finishes available. Available in standard wood finishes and in a full range of DJ Leathers or COM/COL upon approval.

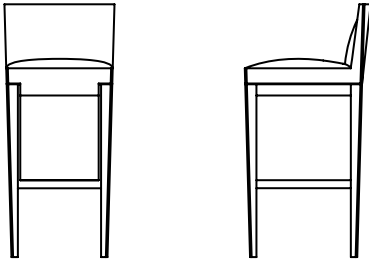

Uno (top)

16.625" w x 16.625" d x 31" h

COM 2 YD

COL 18 Sq Ft

Description

Solid Cherry or Maple Frame. Stainless Double H Bar, Foot Rail and accents. Fully upholstered seat. All metal finishes available. Available in standard wood finishes and in a full range of DJ Leathers or COM/COL upon approval.

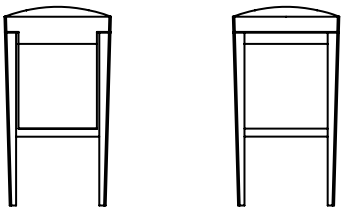

Shown as: DJ Calf "Black" 02

DAKOTA
JACKSON

Dakota Jackson,
Flagship Showroom
979 Third Ave #501,
New York, NY 10022
Tel. 212.838.9444
info@dakotajackson.com



DAKOTA JACKSON
DJ



Bridges
DESK

BRIDGES DESK

Description

75"w x 33.75"d x 30"h

Streamlined desk with 3 drawers and inset glass top with Brass detailing.

All veneer groups available.

All metal finishes available.

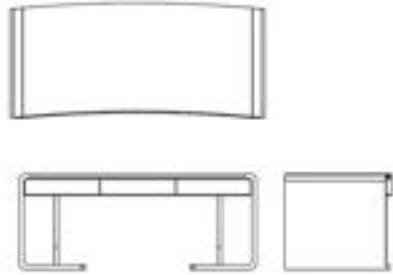

Shown as: Quarter Figured Walnut with Brass Details.

DAKOTA
JACKSON

Dakota Jackson,
Flagship Showroom
979 Third Ave #501,
New York, NY 10022
Tel. 212.838.9444
info@dakotajackson.com



DAKOTA JACKSON
DJ



Bridges

SIDE & COCKTAIL TABLES

BRIDGES SIDE & COCKTAIL TABLES

Description

Side Table

25"w x 17"d x 20"h

3/4" Low Iron Glass top and shelf with veneered frame and brass accents.

All veneer groups available.

All metal finishes available.

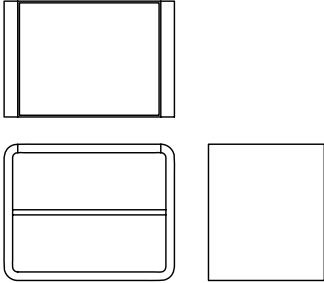
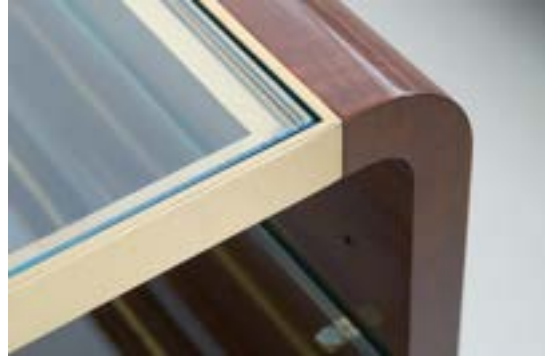

Cocktail Table

40"w x 40"d x 16"h

3/4" Low Iron Glass top and shelf with veneered frame and brass accents.

All veneer groups available.

All metal finishes available.



DAKOTA
JACKSON

Dakota Jackson,
Flagship Showroom
979 Third Ave #501,
New York, NY 10022
Tel. 212.838.9444
info@dakotajackson.com



DAKOTA JACKSON
DJ



Checkerboard
CHAIR

CHECKERBOARD CHAIR

Description

28.5" w x 25" d x 27.25" h; 18" seat ht.

COM 5.5 YD

COL 82 Sq Ft

Fully upholstered tufted cube chair with Polished Stainless Steel legs. Checkerboard inspired design. Available in standard wood finishes and in a full range of DJ Leathers or COM/COL upon approval.

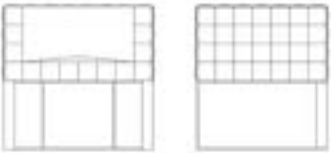

Shown as: DJ Gallery "Fumo" #2650

DAKOTA
JACKSON

Dakota Jackson,
Flagship Showroom
979 Third Ave #501,
New York, NY 10022
Tel. 212.838.9444
info@dakotajackson.com



Shown as: DJ Calf "Cream" #199

*Actual color and finish may vary slightly



DAKOTA JACKSON
DJ



Collections

