

SPECIFICATIONS:

PIZZA PREP TABLES

IPT-75



Italiana FoodTech's refrigerated prep table is an all-in-one pizza workstation. With your pizza dough stored underneath, your toppings at arms reach, and a spacious area for stretching your pizzas, the Italiana FoodTech pizza prep tables are designed with efficiency in mind. The bottom of the prep table conveniently stores your pizza dough.

The smooth granite work area provides a smooth surface to work on, providing the perfect amount of traction when stretching the dough while preventing the pizza from sticking to the work surface. The chilled topping compartment provides a flexible and convenient way to hold fresh pizza toppings for preparation. The trays allow the chef to work faster, maintain a clean work area and keep toppings chilled. With three sizes to choose from; there is a pizza prep table to satisfy every need, space and work area.

FEATURES:

- Digital temperature controls
- Independent topping tray cooler with glass sneeze guard
- Automatic defrost: through simple stop compressor pause
- 50mm of high density polyurethane-foam insulation
- Ventilated refrigeration system
- Compressor can be on left or right side
- Automatic water defrost evaporation feature
- Elevated refrigerated topping compartment
- Table working temperature: 0°/+8°C (ventilated)
- Pan cooler working temperature: +4°/+8°C (static)
- Highly insulated to prevent temperature variation
- Fits standard size chilled topping trays
- Large granite work surface
- Can store up to 300 dough balls in Italiana FoodTech dough containers (10-18 balls per container) storage compartments

IPT-75 PIZZA PREP TABLE

Electrical Information

Model	Voltage	Cord Length
Prep Table	110v	51½" (130cm)
Topping Tray	110v	55" (140cm)

Plug Type: Nema 5-15p 

Note: both top and bottom refrigeration have independent compressors and power.

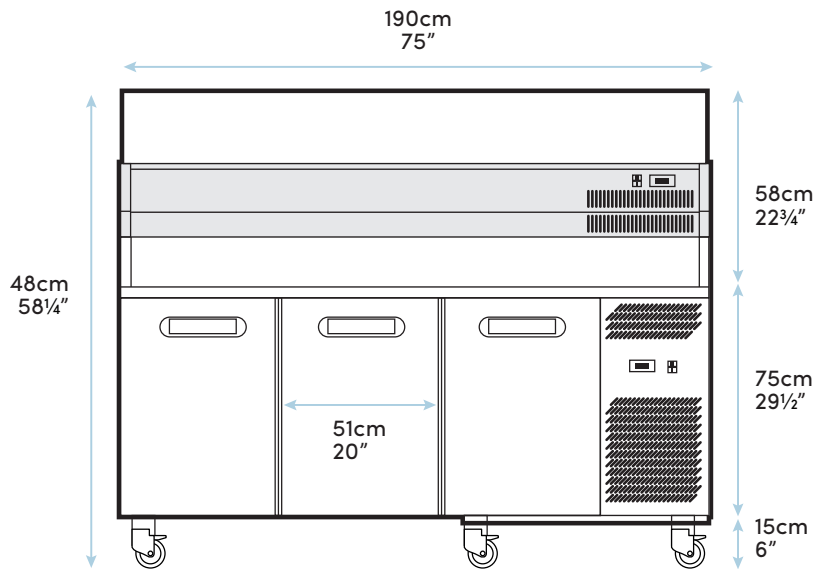
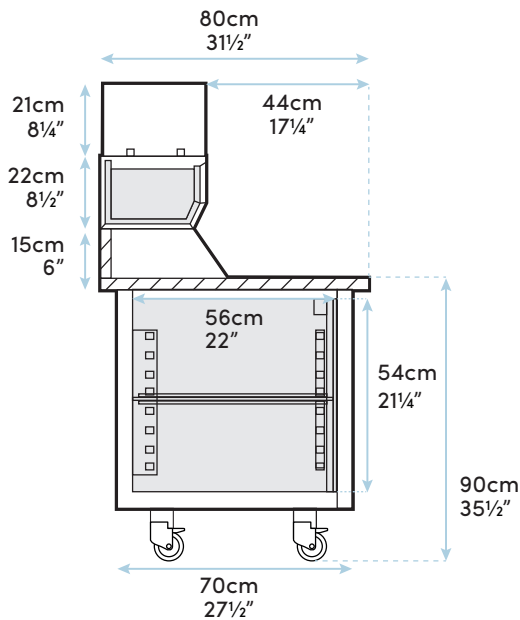
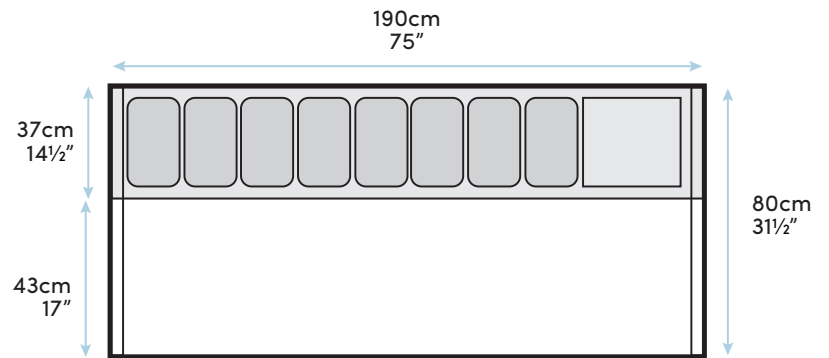

Model Dimensions

Dimensions Inch			Dimensions cm			Countertop Height		Weight	
W	D	H	W	D	H	Inch	cm	Lb	Kg
75	31	58	190	80	148	35	90	683	310

Shipping Dimensions

Dimensions Inch			Dimensions cm			Weight	
W	D	H	W	D	H	Lb	Kg
80	40	57	200	90	145	730	330

Additional Information

Number of Compartments	Number of Drawers	Pizza Count	Compartment Dimensions Inch			Compartment Dimensions cm			Countertop Dimensions Inch		Countertop Dimensions cm	
			W	D	H	W	D	H	W	D	W	D
3	0	8-10	20	22	21¼	51	56	54	75	31½	190	80



The manufacturer reserves the right to modify the technical data and models without previous notice.

ITALIANA Foodtech
 815 Alness St. Toronto Ont. M3J 2H8 Canada
 T: 647.577.3477 - F: 647.977.9214
info@italiana.ca / www.italiana.ca