

INSTALLATION GUIDE

Switch System

3 Person Run

Size: 1800x800 mm

www.jasonl.com.au

Need help!

Call us on
1300 527 665

jason.l
your office furniture mate

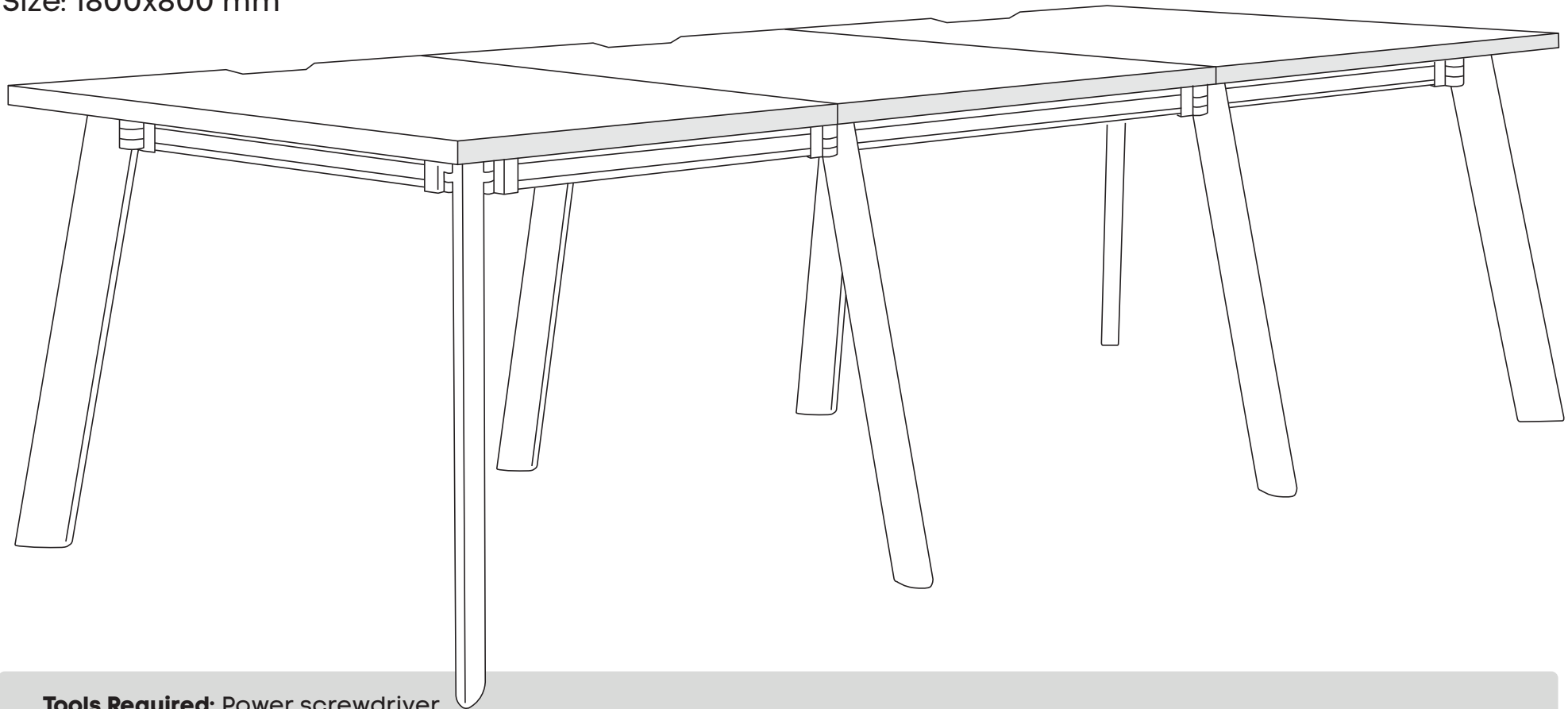

Tools Required: Power screwdriver.

Note: Please ignore any pre-drilled holes or nut inserts that maybe present in your top(s). They will not match your particular table/desk base and woods screws will be required to be screwed directly into the underside of the top.

Note: It is important to fully tighten all bolts and screws before attaching the top(s) so that the frame is sufficiently rigid. Failure to do this may affect stability once the tops are attached.

INSTALLATION GUIDE

Switch System

3 Person Run

Size: 1800x800 mm

www.jasonl.com.au

Need help!

Call us on
1300 527 665

jason.l
your office furniture mate

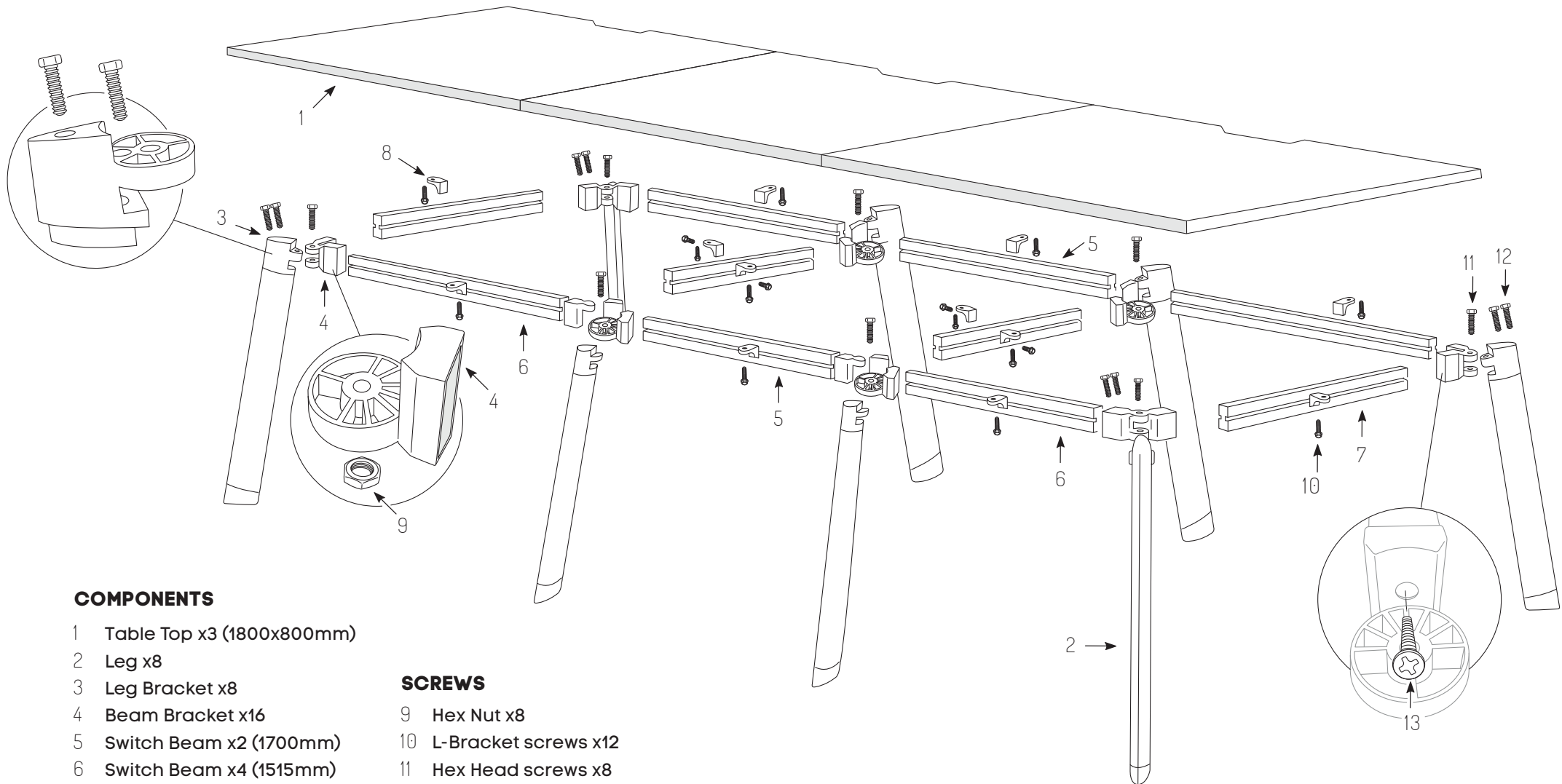

COMPONENTS

- 1 Table Top x3 (1800x800mm)
- 2 Leg x8
- 3 Leg Bracket x8
- 4 Beam Bracket x16
- 5 Switch Beam x2 (1700mm)
- 6 Switch Beam x4 (1515mm)
- 7 Switch Beam x4 (325mm)
- 8 L-Bracket x12

SCREWS

- 9 Hex Nut x8
- 10 L-Bracket screws x12
- 11 Hex Head screws x8
- 12 M8x40mm Bolt x16
- 13 M8x20mm Bolt x20

INSTALLATION GUIDE

Switch System

3 Person Run

www.jasonl.com.au

Need help!

Call us on
1300 527 665

jason.l
your office furniture mate



Size: 1800x800 mm

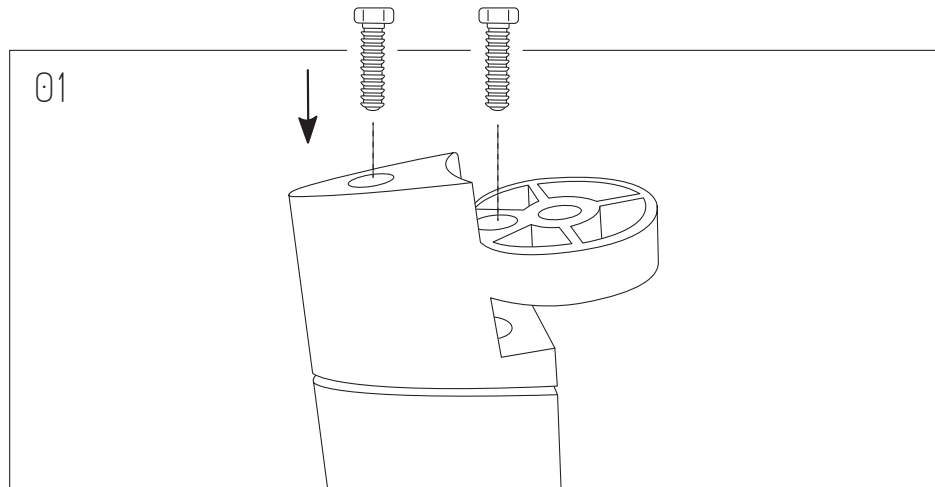

Join Leg Brackets to each Leg using screws to secure them, as follow.

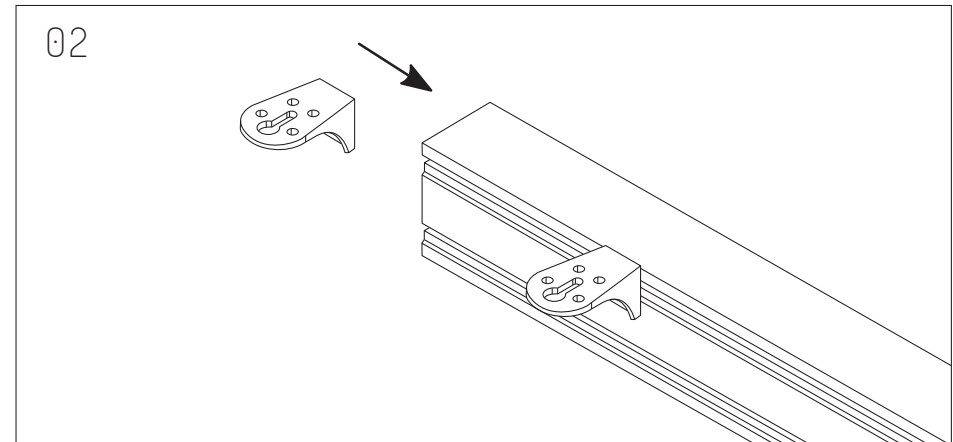

Join 1 L-Bracket through each Beam.

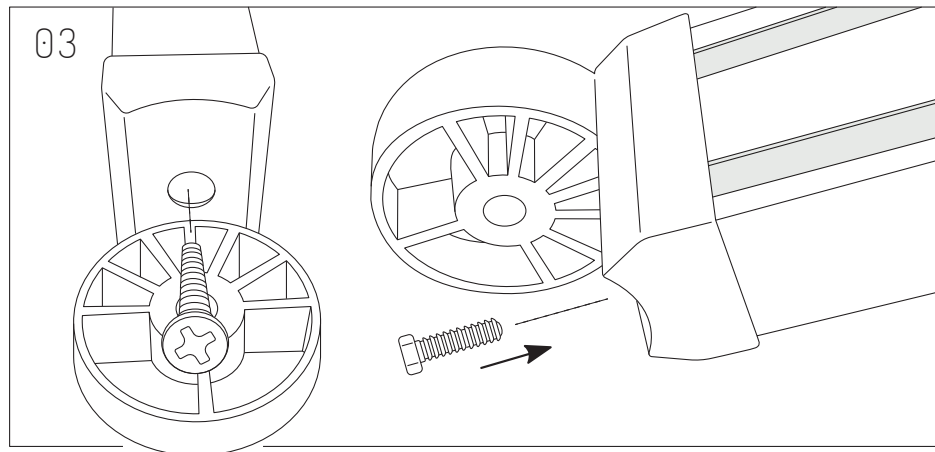

Securely connect each Beam to each Beam Bracket. Screw to secure.

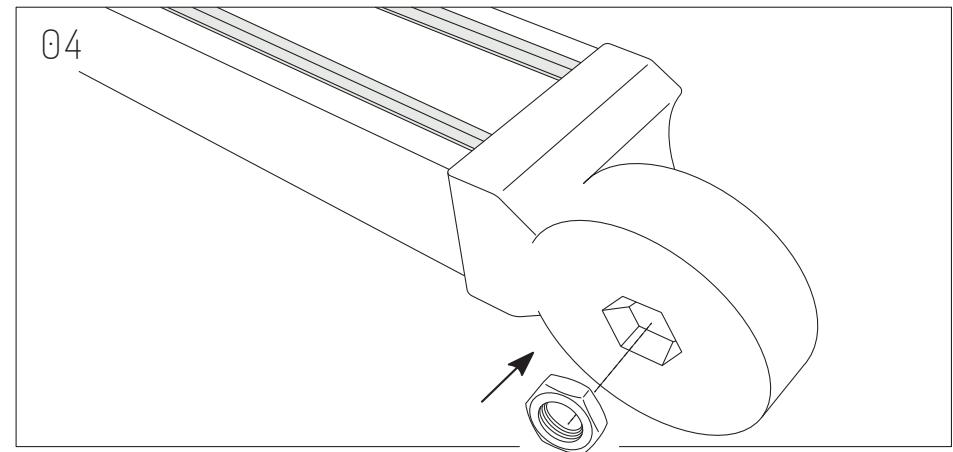

Insert Hex Nut on each Beam Bracket.

INSTALLATION GUIDE

Switch System

3 Person Run

Size: 1800x800 mm

www.jasonl.com.au

Need help!

Call us on
1300 527 665

jason.l
your office furniture mate

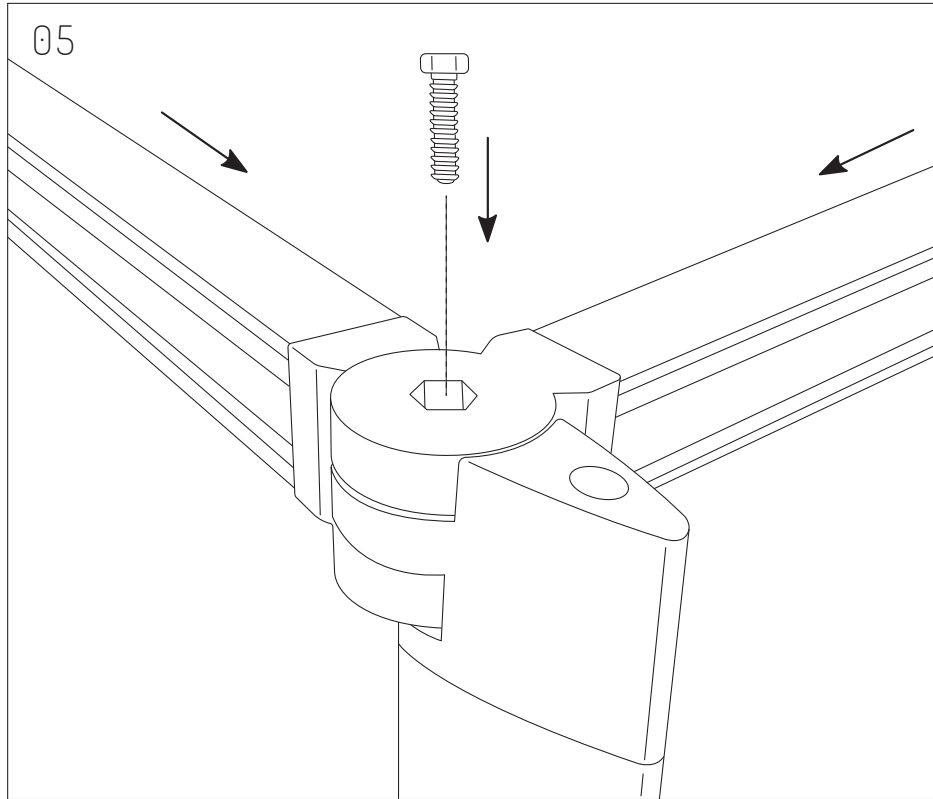

Position as presented, and proceed to screw to ensure each corner of the frame.

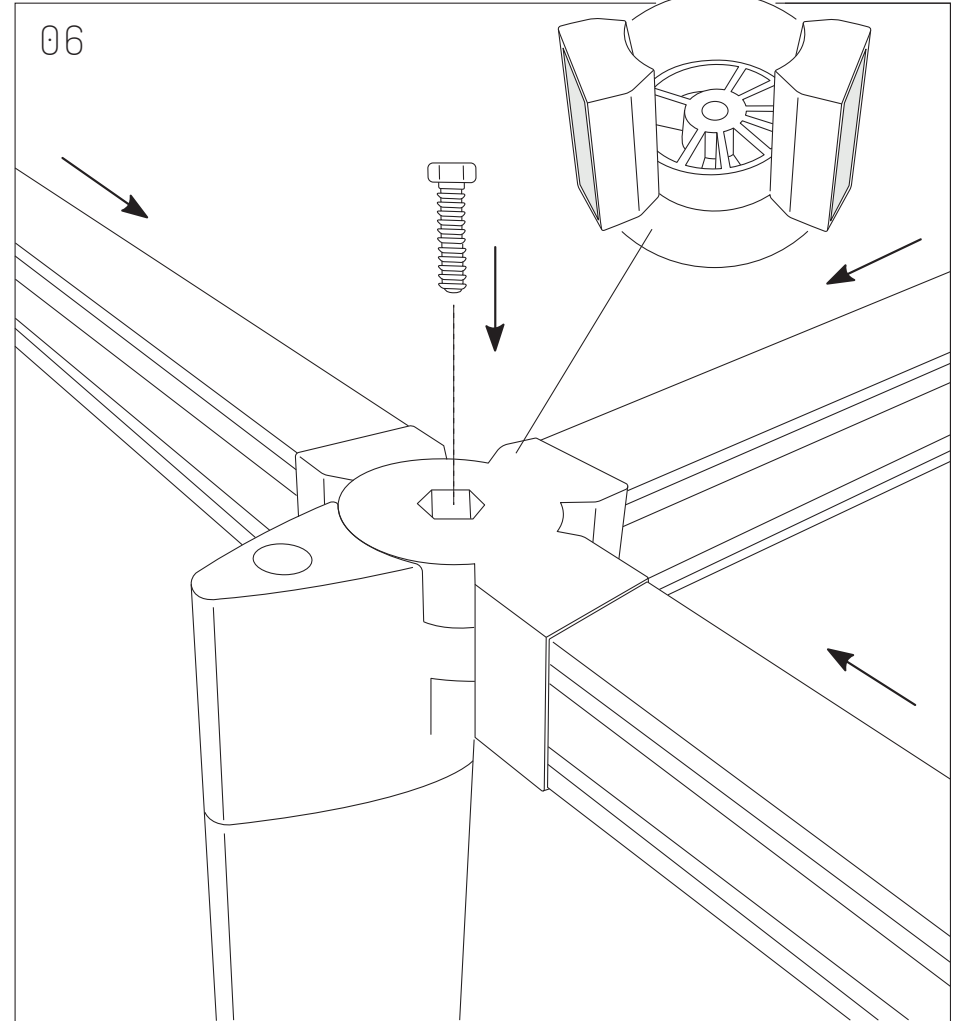
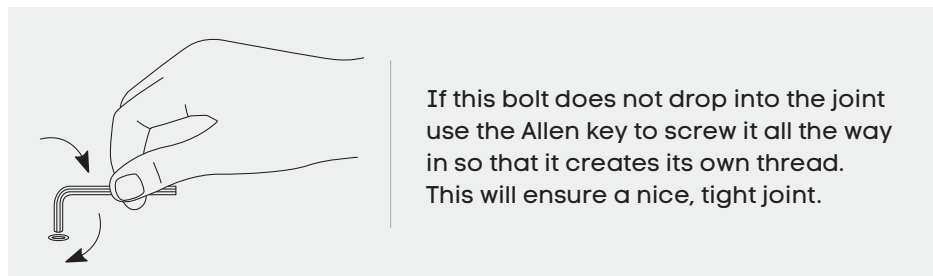

For the 4 central legs, attach as presented, using T Beam Bracket.

INSTALLATION GUIDE

Switch System

3 Person Run

Size: 1800x800 mm

www.jasonl.com.au

Need help!

Call us on
1300 527 665

jason.l
your office furniture mate



Note: It is important to fully tighten all bolts and screws before attaching the top(s) so that the frame is sufficiently rigid. Failure to do this may affect stability once the tops are attached.

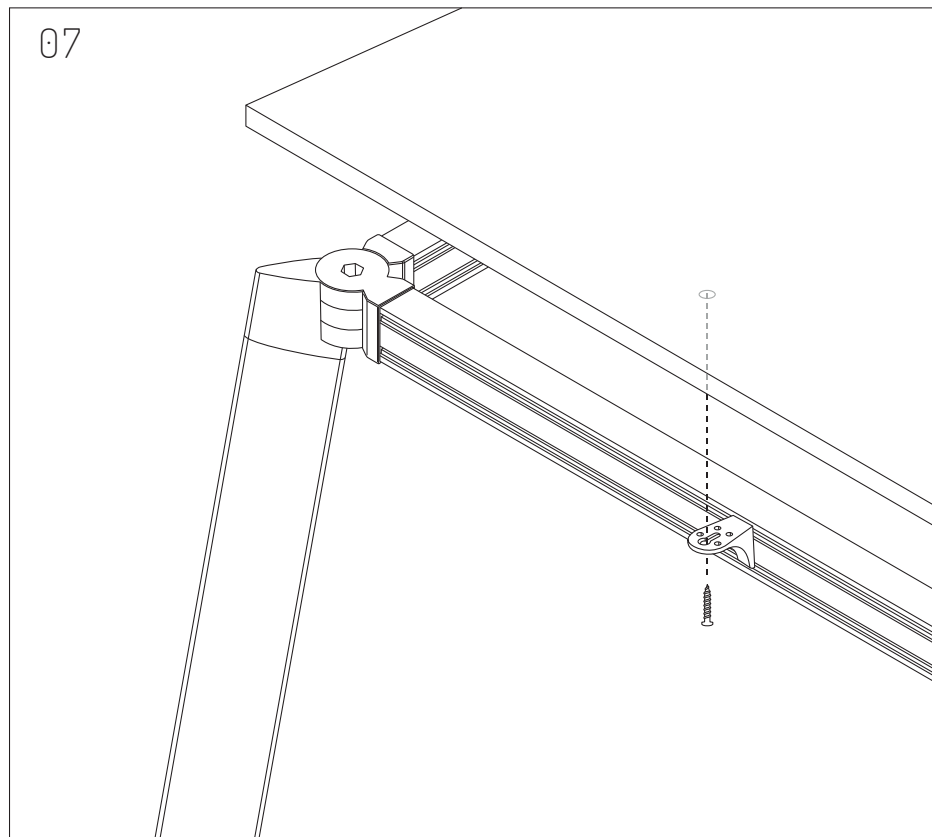

Directly screw into table tops, using L-Bracket screws through each L-Bracket.