

# INSTALLATION GUIDE

## Switch System

### 2 Person Run

Size: 1200x800 mm

[www.jasonl.com.au](http://www.jasonl.com.au)

**Need help!**

Call us on  
**1300 527 665**

**jason.l**  
your office furniture mate

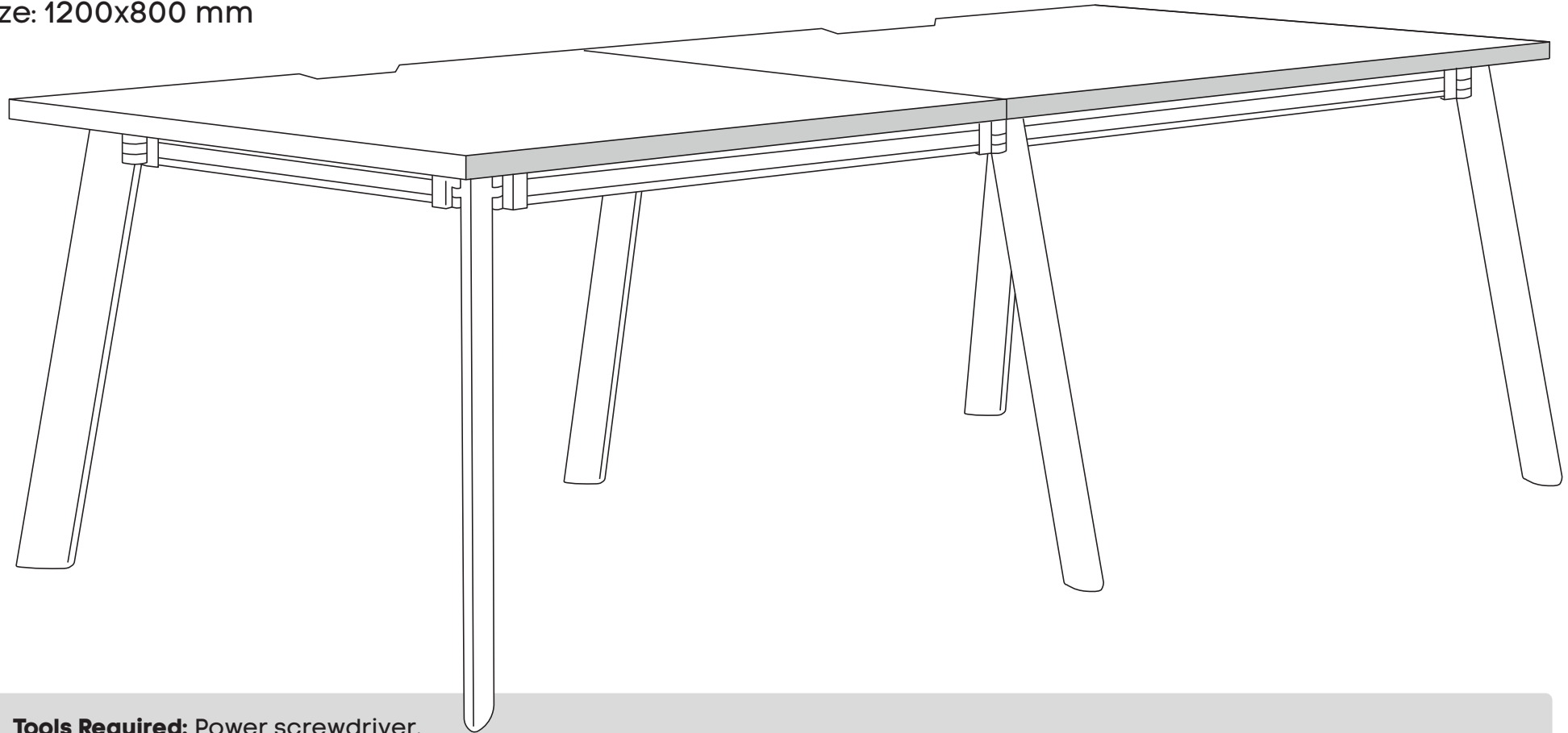

**Tools Required:** Power screwdriver.

**Note:** Please ignore any pre-drilled holes or nut inserts that maybe present in your top(s). They will not match your particular table/desk base and woods screws will be required to be screwed directly into the underside of the top.

**Note:** It is important to fully tighten all bolts and screws before attaching the top(s) so that the frame is sufficiently rigid. Failure to do this may affect stability once the tops are attached.

# INSTALLATION GUIDE

## Switch System

### 2 Person Run

Size: 1200x800 mm

[www.jasonl.com.au](http://www.jasonl.com.au)

**Need help!**

Call us on  
**1300 527 665**

**jason.l**  
your office furniture mate

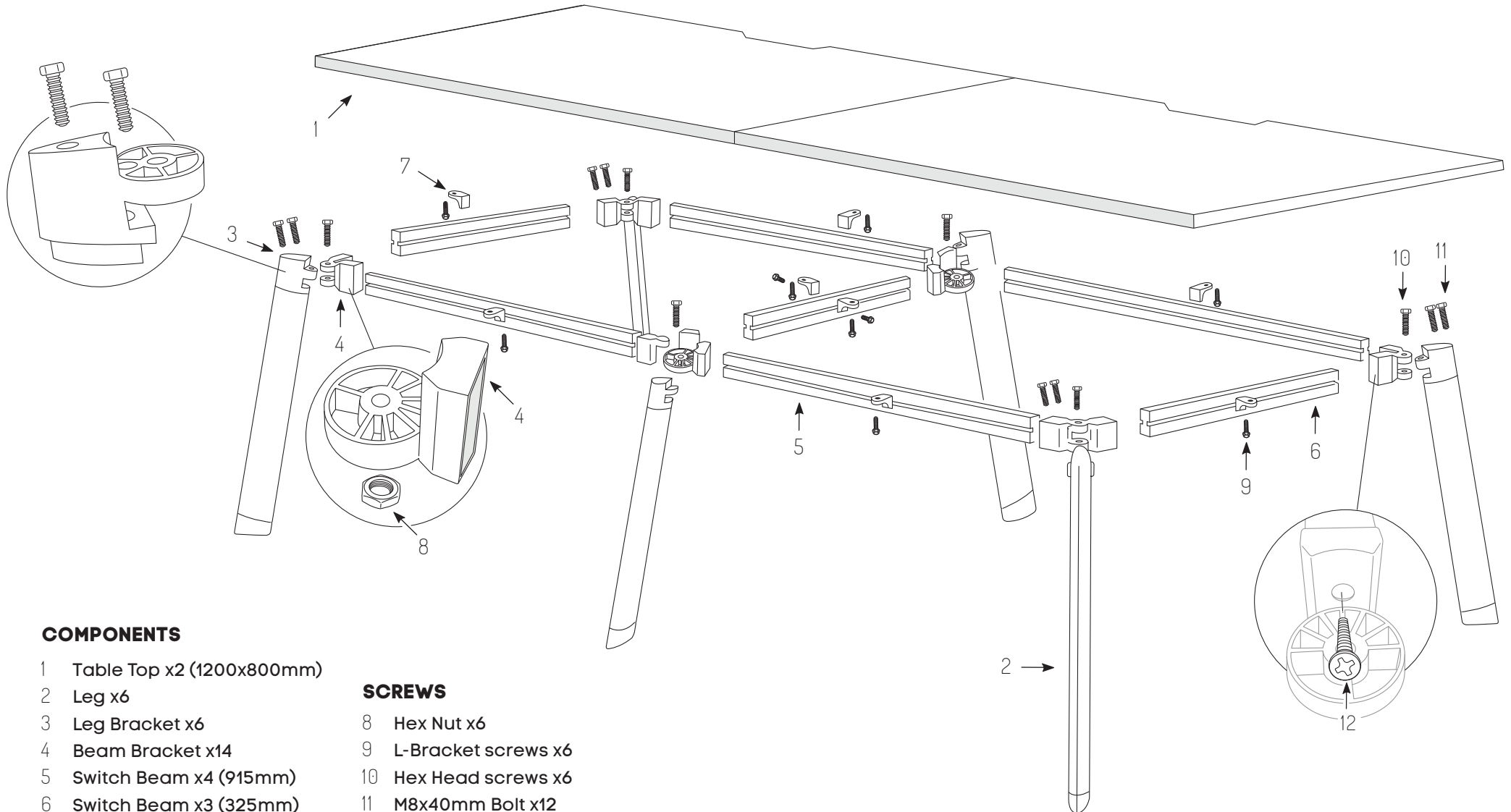

#### COMPONENTS

- 1 Table Top x2 (1200x800mm)
- 2 Leg x6
- 3 Leg Bracket x6
- 4 Beam Bracket x14
- 5 Switch Beam x4 (915mm)
- 6 Switch Beam x3 (325mm)
- 7 L-Bracket x8

#### SCREWS

- 8 Hex Nut x6
- 9 L-Bracket screws x6
- 10 Hex Head screws x6
- 11 M8x40mm Bolt x12
- 12 M8x20mm Bolt x14

# INSTALLATION GUIDE

## Switch System

### 2 Person Run

Size: 1200x800 mm

[www.jasonl.com.au](http://www.jasonl.com.au)

**Need help!**

Call us on  
**1300 527 665**

**jason.l**  
your office furniture mate

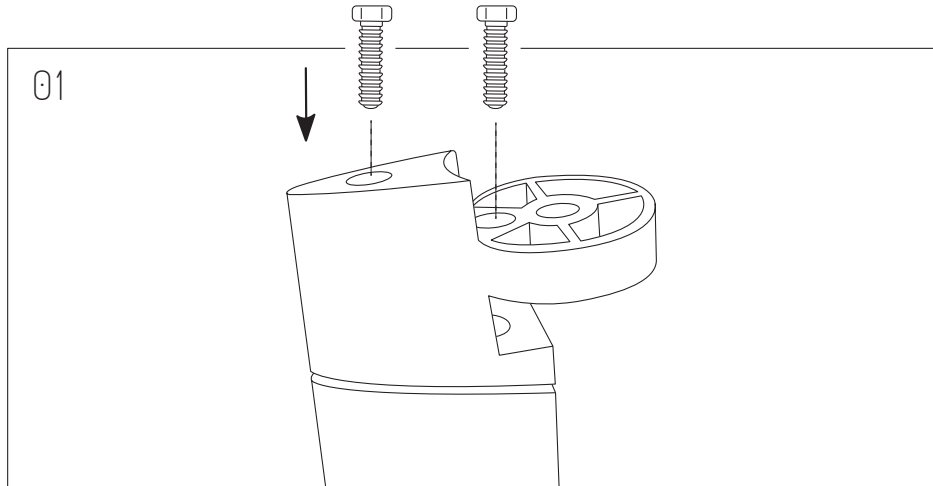

Join Leg Brackets to each Leg using screws to secure them, as follow.

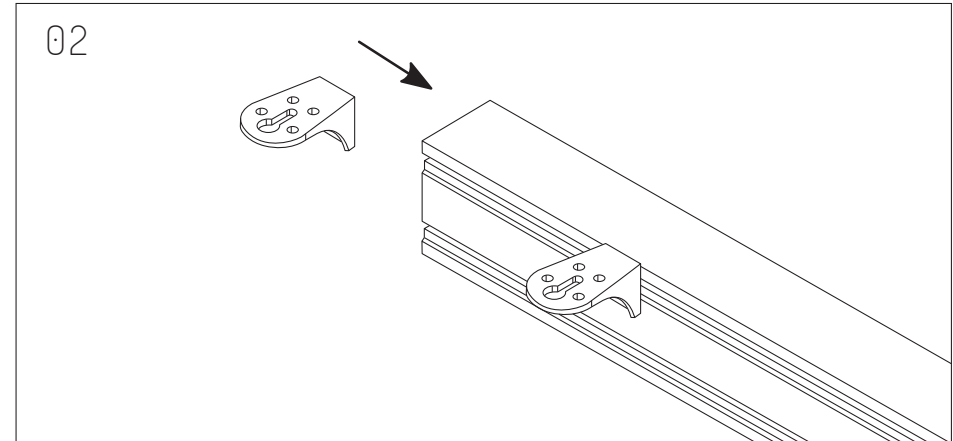

Join 1 L-Bracket through each 1315mm Beam and 1 L-Bracket through each 325mm Beam.

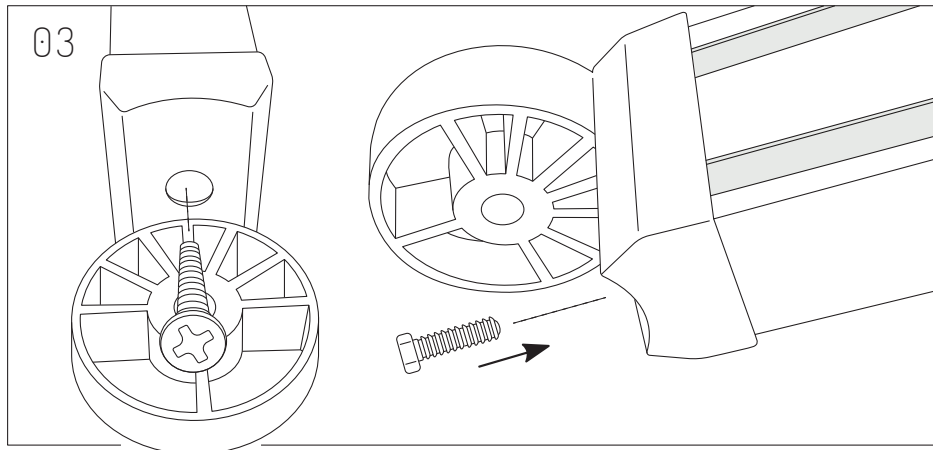

Securely connect each Beam to each Beam Bracket. Screw to secure.

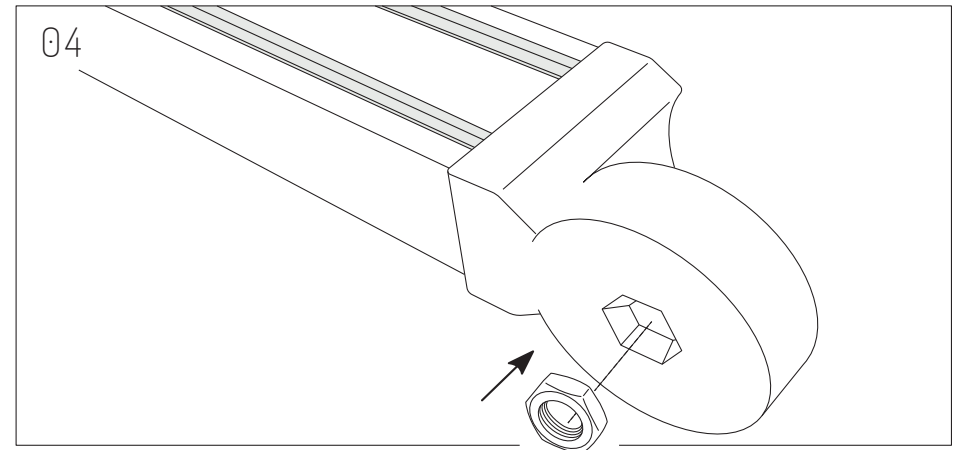

Insert Hex Nut on each Beam Bracket.

# INSTALLATION GUIDE

## Switch System

### 2 Person Run

Size: 1200x800 mm

[www.jasonl.com.au](http://www.jasonl.com.au)

**Need help!**

Call us on  
**1300 527 665**

**jason.l**  
your office furniture mate

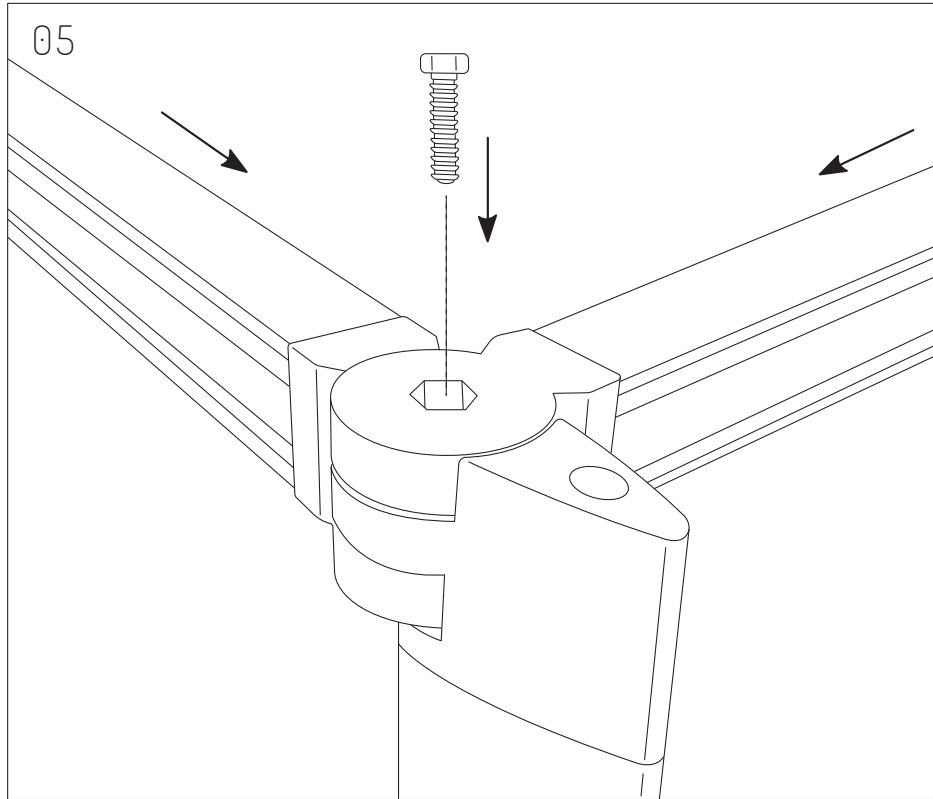

Position as presented, and proceed to screw to ensure each corner of the frame.

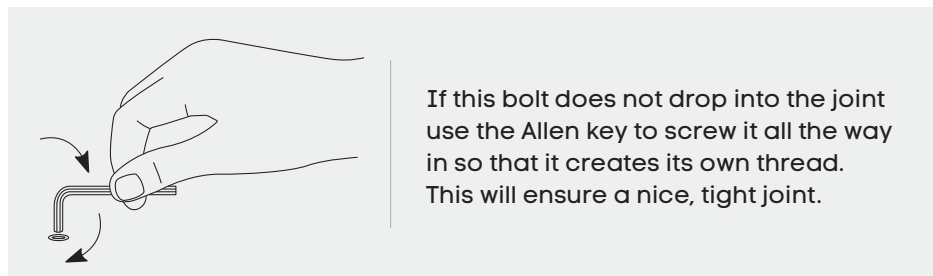

If this bolt does not drop into the joint use the Allen key to screw it all the way in so that it creates its own thread. This will ensure a nice, tight joint.

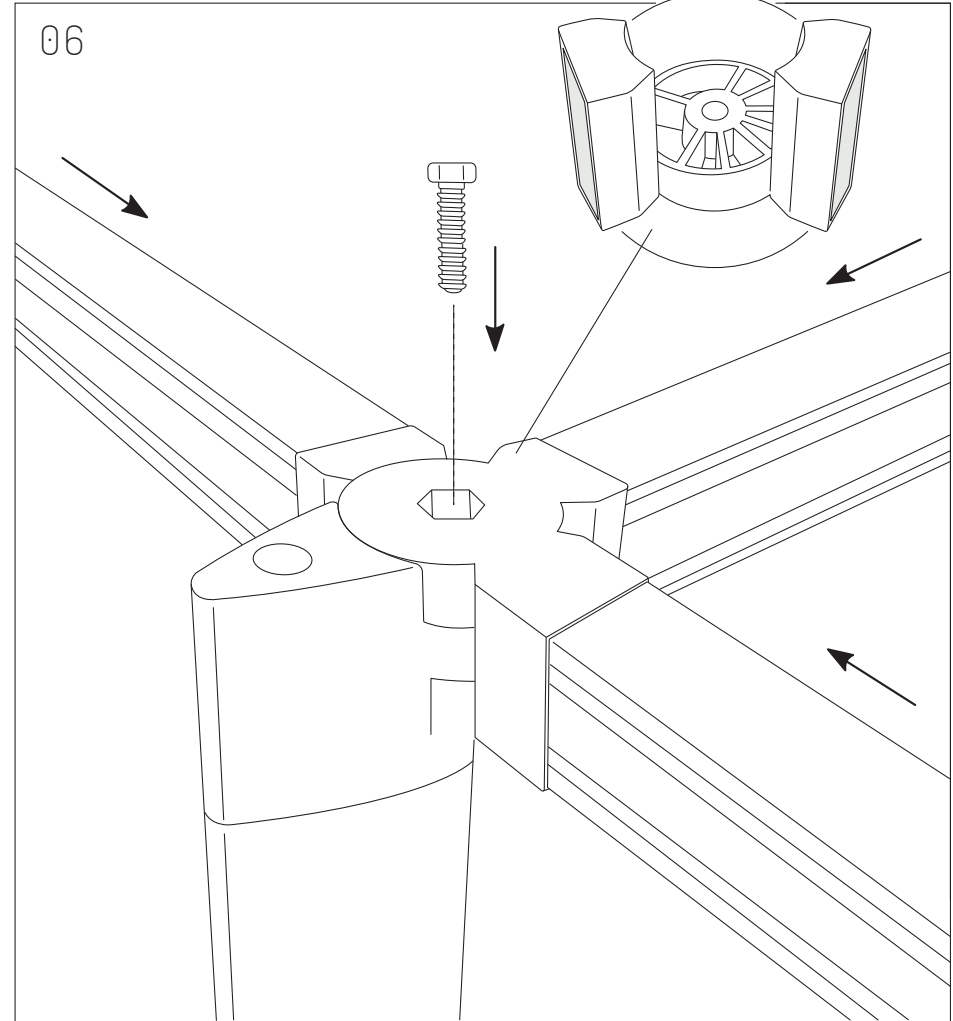

For the 2 central legs, attach as presented, using T Beam Bracket.

# INSTALLATION GUIDE

## Switch System

### 2 Person Run

Size: 1200x800 mm

[www.jasonl.com.au](http://www.jasonl.com.au)

**Need help!**

Call us on  
**1300 527 665**

**jason.l**  
your office furniture mate



**Note:** It is important to fully tighten all bolts and screws before attaching the top(s) so that the frame is sufficiently rigid. Failure to do this may affect stability once the tops are attached.

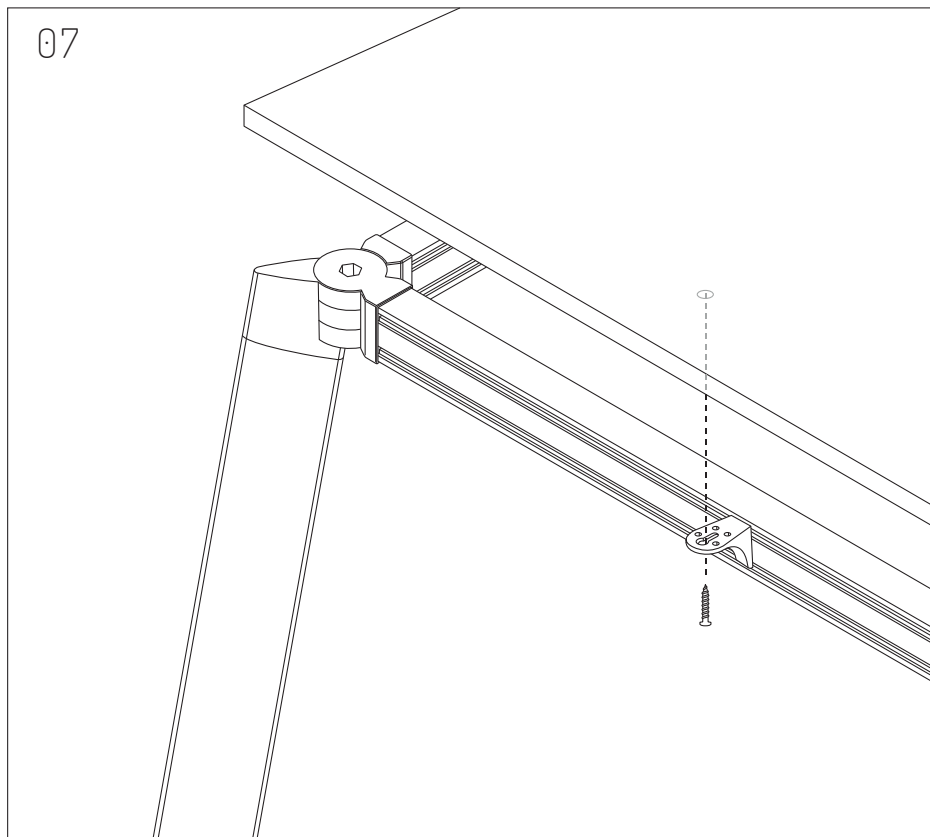

Directly screw into table tops, using L-Bracket screws through each L-Bracket.