

INSTALLATION GUIDE

Switch System Single Desk

Size: 1400 x 800 mm

www.jasonl.com.au

Need help!

Call us on
1300 527 665

jason.l
your office furniture mate

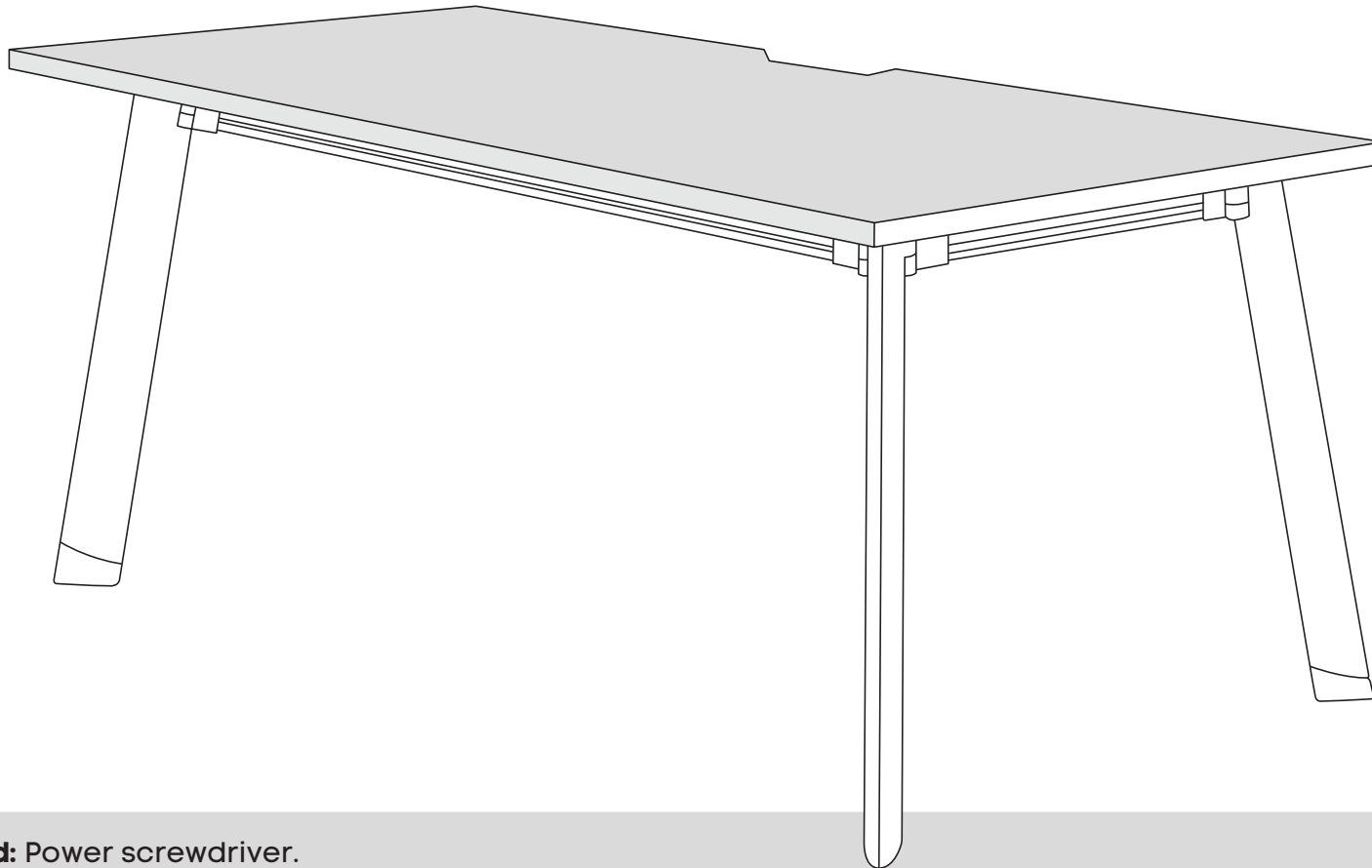

Tools Required: Power screwdriver.

Note: Please ignore any pre-drilled holes or nut inserts that maybe present in your top(s). They will not match your particular table/desk base and woods screws will be required to be screwed directly into the underside of the top.

Note: It is important to fully tighten all bolts and screws before attaching the top(s) so that the frame is sufficiently rigid. Failure to do this may affect stability once the tops are attached.

INSTALLATION GUIDE

Switch System Single Desk

Size: 1400 x 800 mm

www.jasonl.com.au

Need help!

Call us on
1300 527 665

jason.l
your office furniture mate

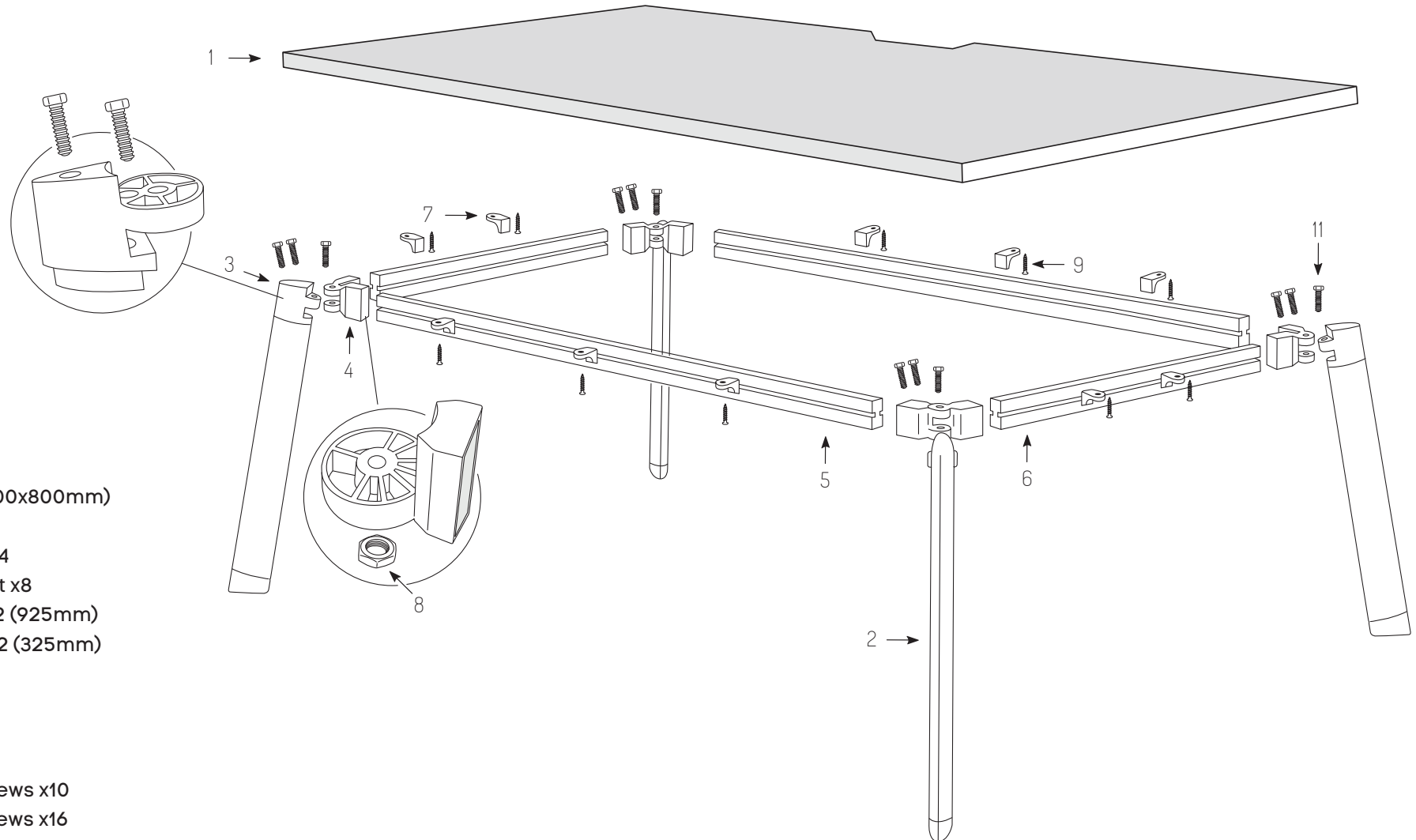

COMPONENTS

- 1 Table Top (1400x800mm)
- 2 Leg x4
- 3 Leg Bracket x4
- 4 Beam Bracket x8
- 5 Long Beam x2 (925mm)
- 6 Short Beam x2 (325mm)
- 7 L-Bracket x10

SCREWS

- 8 Hex Nut x4
- 9 L-Bracket screws x10
- 10 Hex Head screws x16
- 11 M8x25mm Dome Head x4

INSTALLATION GUIDE

Switch System

Single Desk

Size: 1400 x 800 mm

www.jasonl.com.au

Need help!

Call us on
1300 527 665

jason.l
your office furniture mate

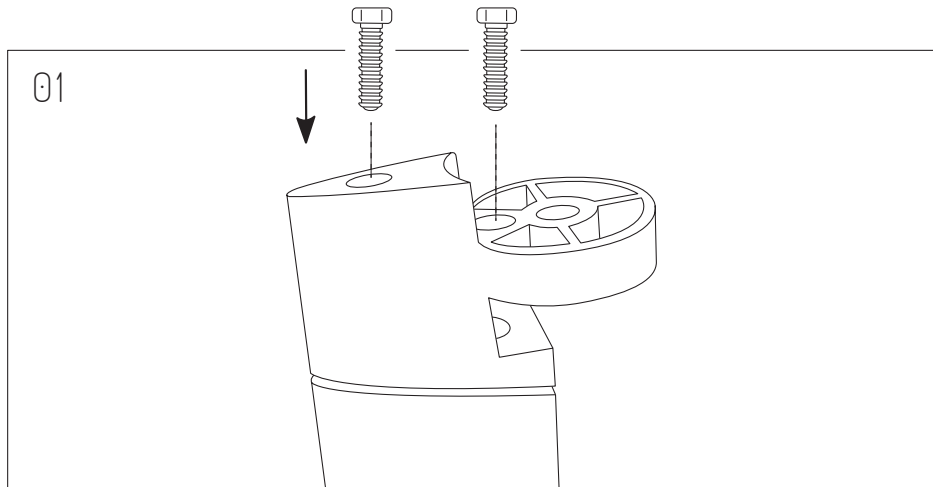

Join Leg Brackets to each Leg using screws to secure them, as follow.

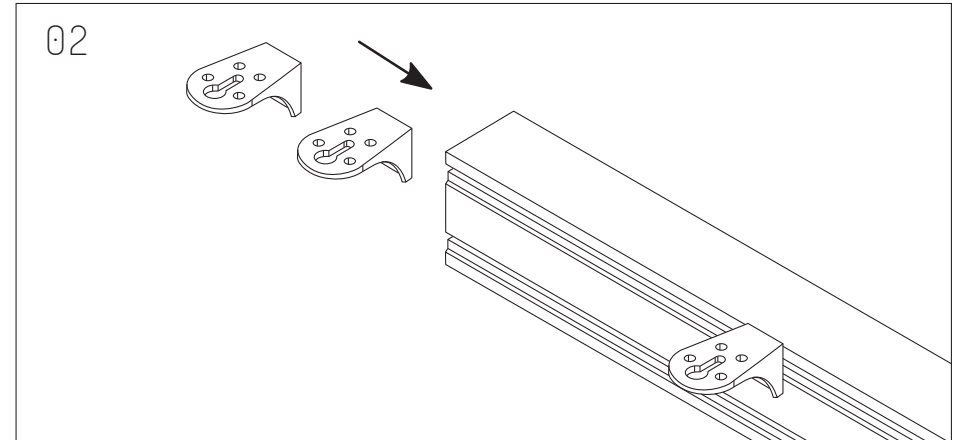

Join 3 L-Bracket through each Long Beam and 2 L-Bracket through each Short Beam.

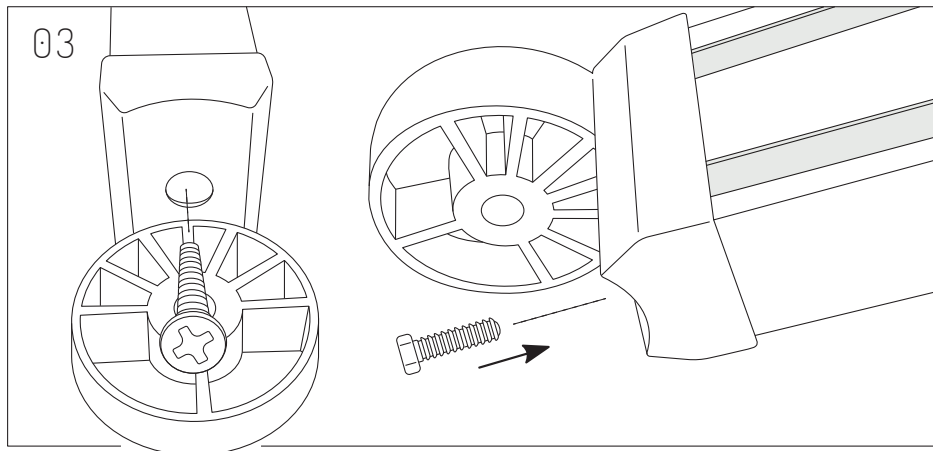

Securely connect each Beam to each Beam Bracket. Screw to secure.

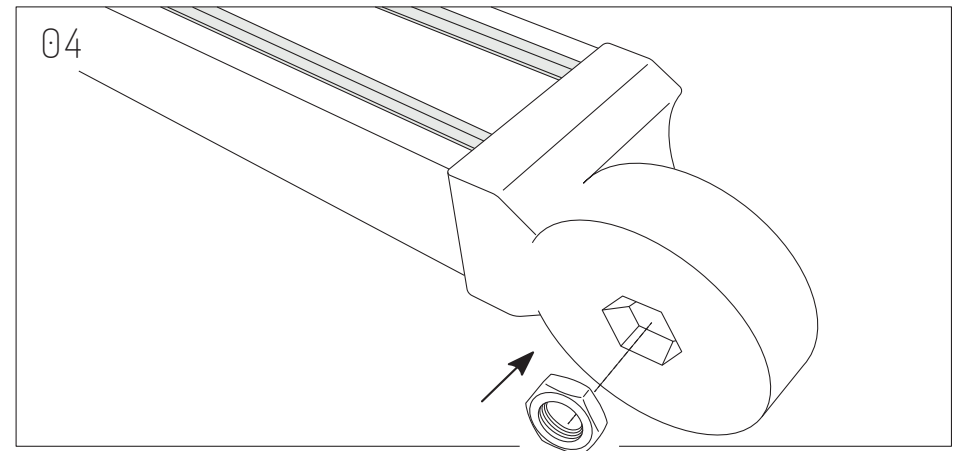

Insert Hex Nut on each Beam Bracket.

INSTALLATION GUIDE

Switch System

Single Desk

Size: 1400 x 800 mm

www.jasonl.com.au

Need help!

Call us on
1300 527 665

jason.l
your office furniture mate

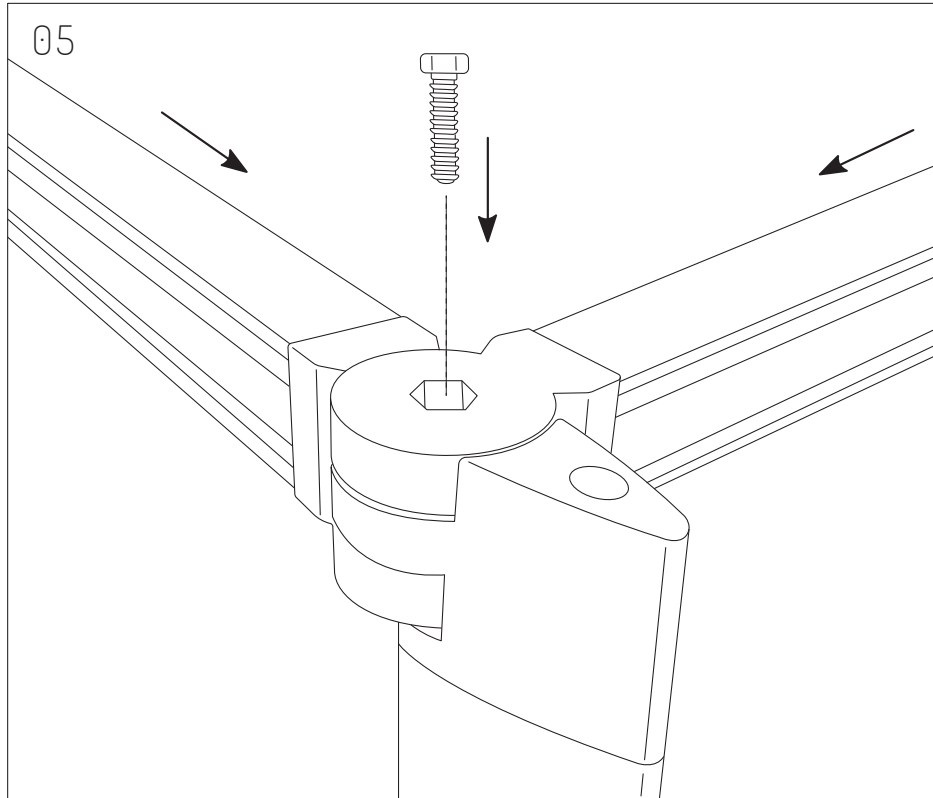

Position as presented, and proceed to screw to ensure each corner of the frame.

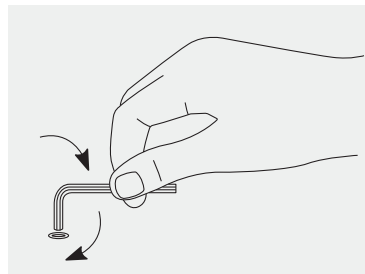

If this bolt does not drop into the joint use the Allen key to screw it all the way in so that it creates its own thread. This will ensure a nice, tight joint.

Note: It is important to fully tighten all bolts and screws before attaching the top(s) so that the frame is sufficiently rigid. Failure to do this may affect stability once the tops are attached.

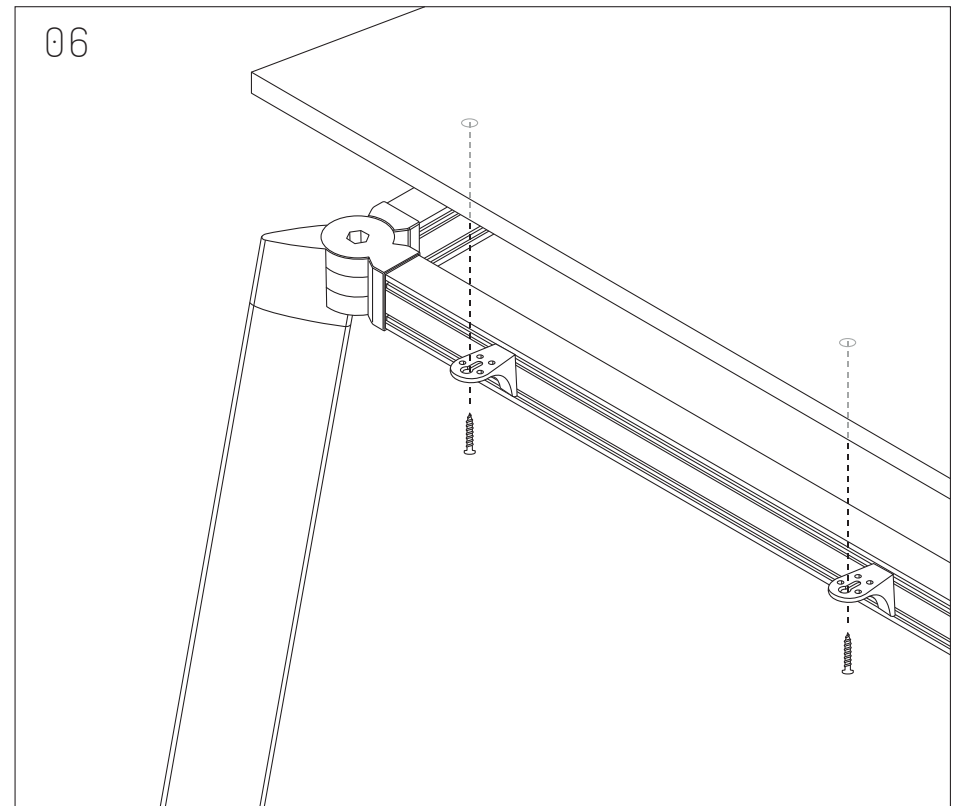

Directly screw into table tops, using L-Bracket screws through each L-Bracket.