

ASSEMBLY INSTRUCTIONS

Quadro Wood CT

Single Legs

Sizes: 800D, 1000D

www.jasonl.com.au

Need help!

Call us on
1300 527 665

jason.l
your office furniture mate

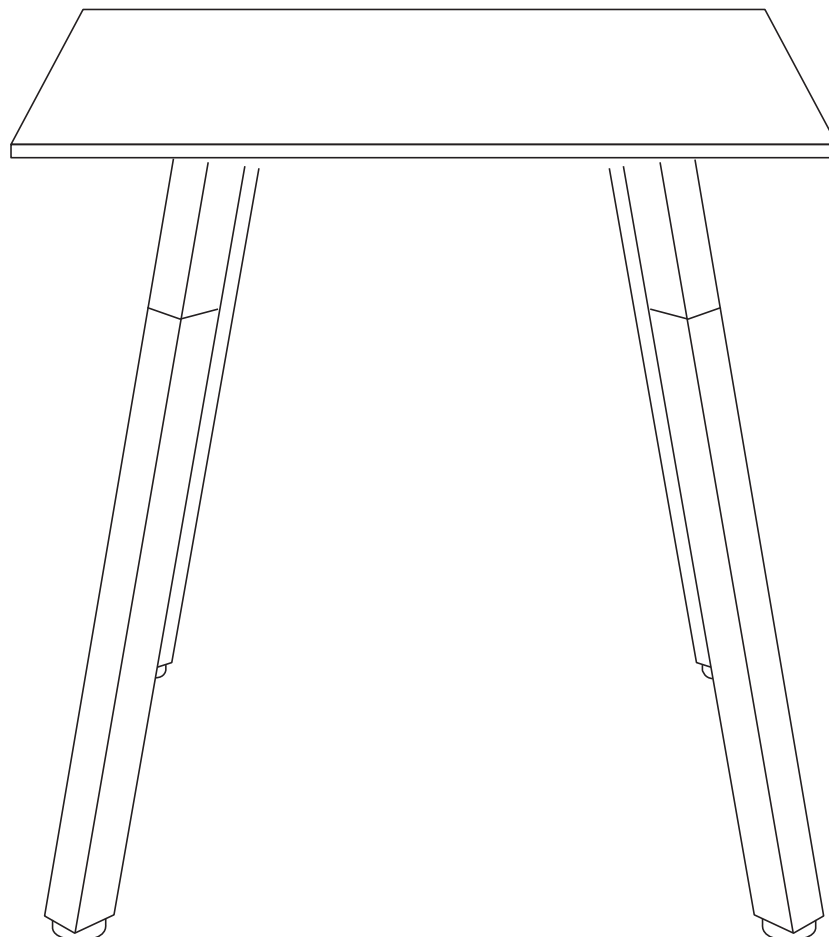

Tools Required: Power screwdriver; Allen key set (provided)

 2 persons required for installation

ASSEMBLY INSTRUCTIONS

Quadro Wood CT

Single Legs

www.jasonl.com.au

Need help!

Call us on
1300 527 665

jason.l
your office furniture mate

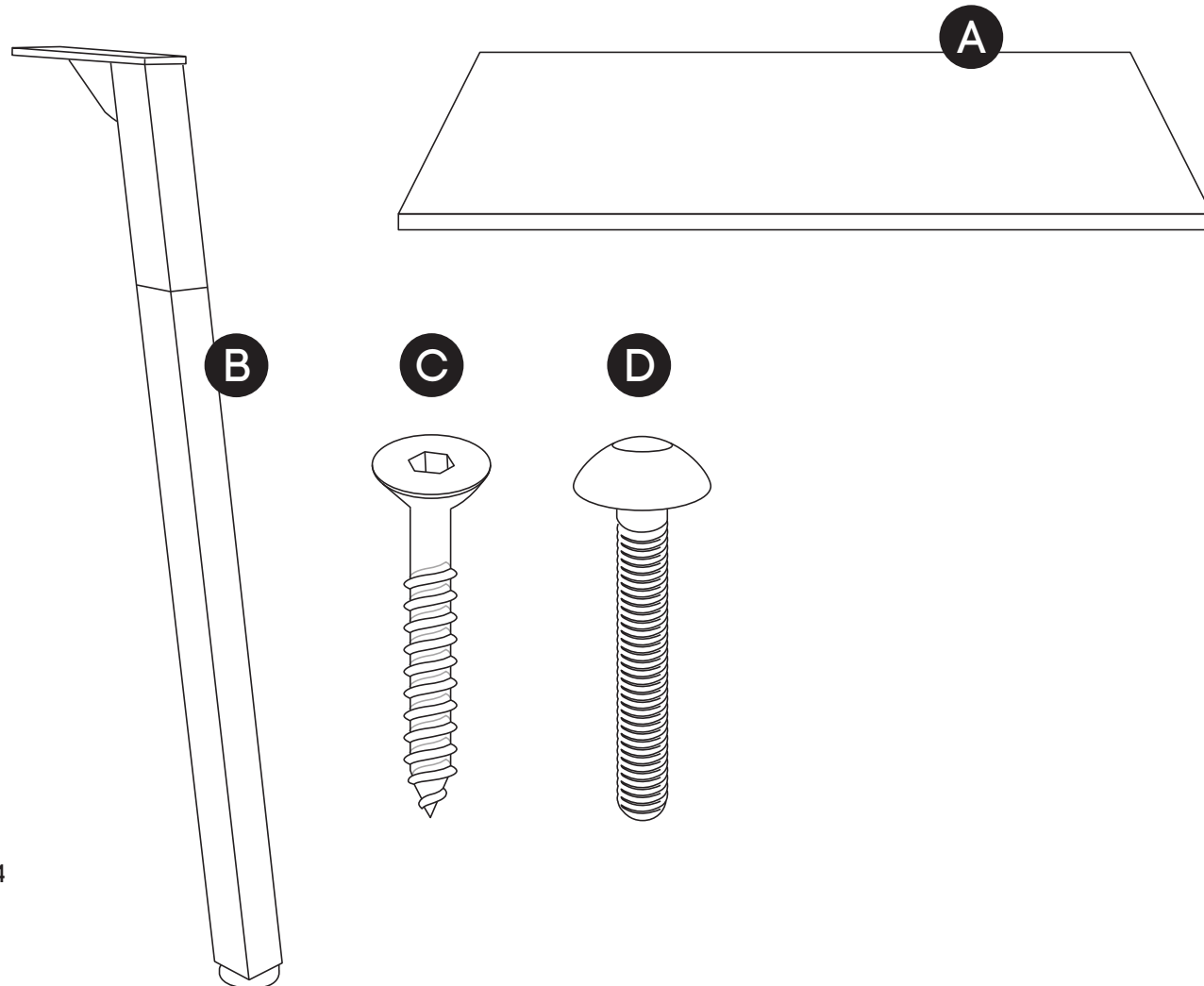

COMPONENTS

- A Table top x1
- B Counter table Leg Quadro Wood x4

SCREWS

- C Wood Screws x16
- D M6x30mm Mushroom head screws x4

E Allen key x1

ASSEMBLY INSTRUCTIONS

Quadro Wood CT

Single Legs

www.jasonl.com.au

Need help!
Call us on
1300 527 665

jason.l
your office furniture mate



TOP
VIEW

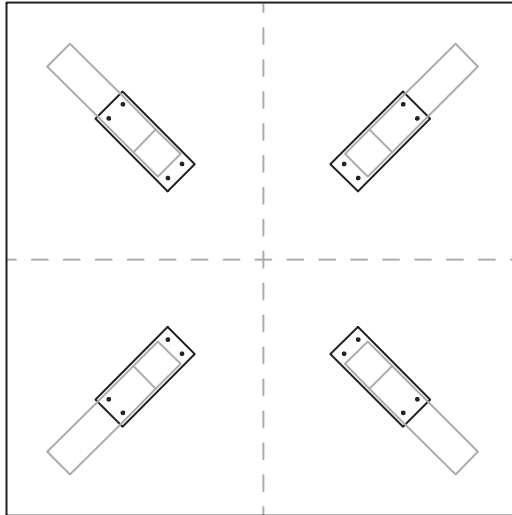

FRONTAL
VIEW

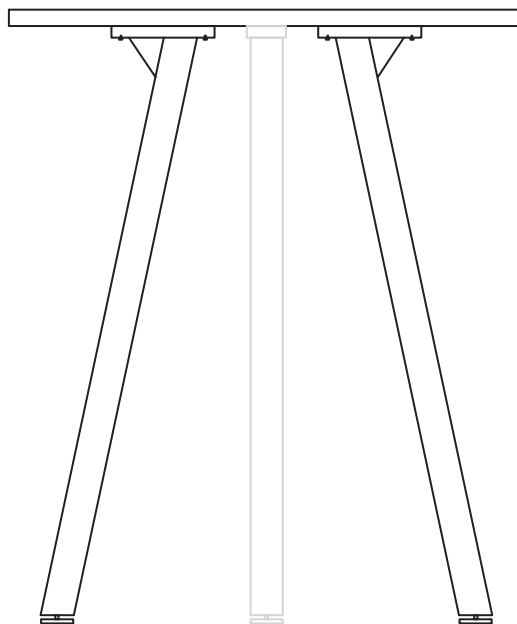

STEP 01

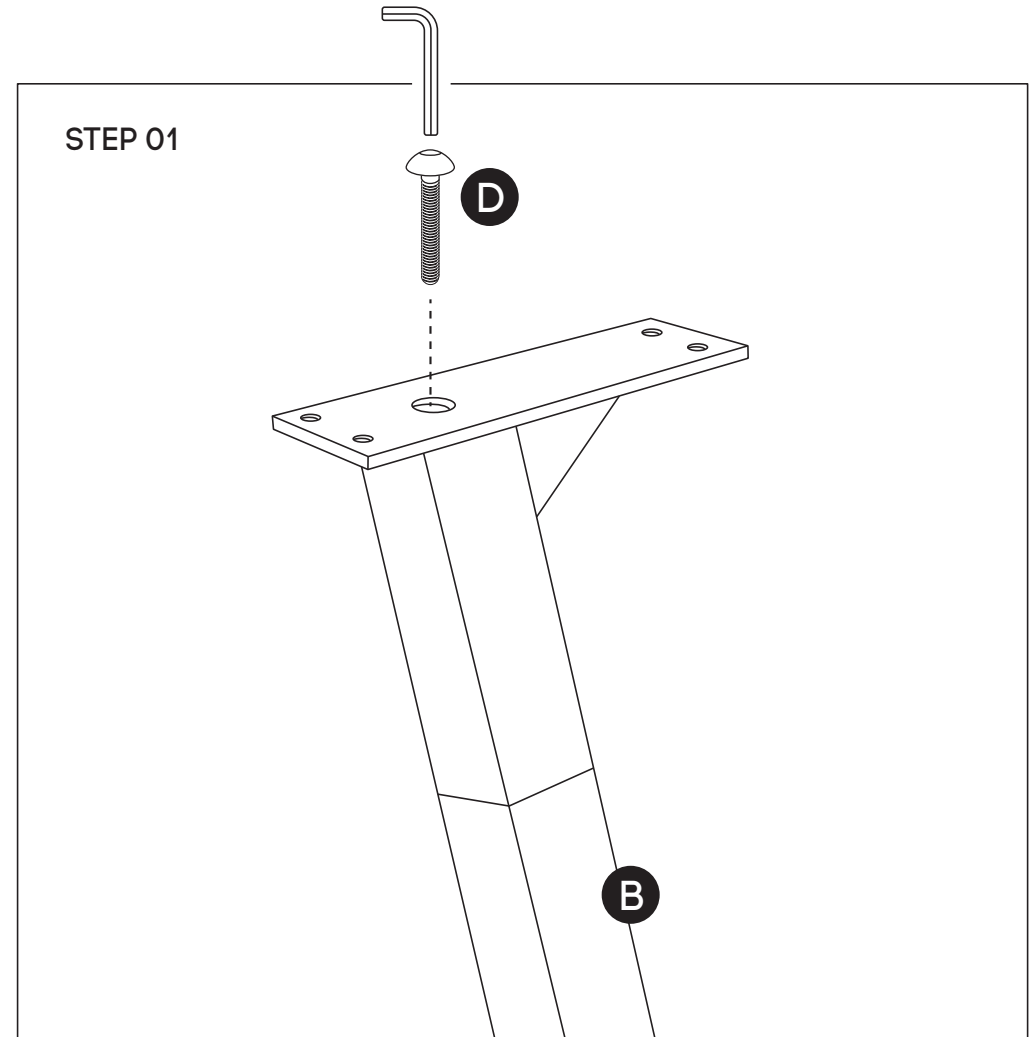

Using Allen Key provided, attach Mushroom Head Screw **(D)** for all legs as shown in the illustration.

ASSEMBLY INSTRUCTIONS

Quadro Wood CT

Single Legs

www.jasonl.com.au

Need help!
Call us on
1300 527 665

jason.l
your office furniture mate

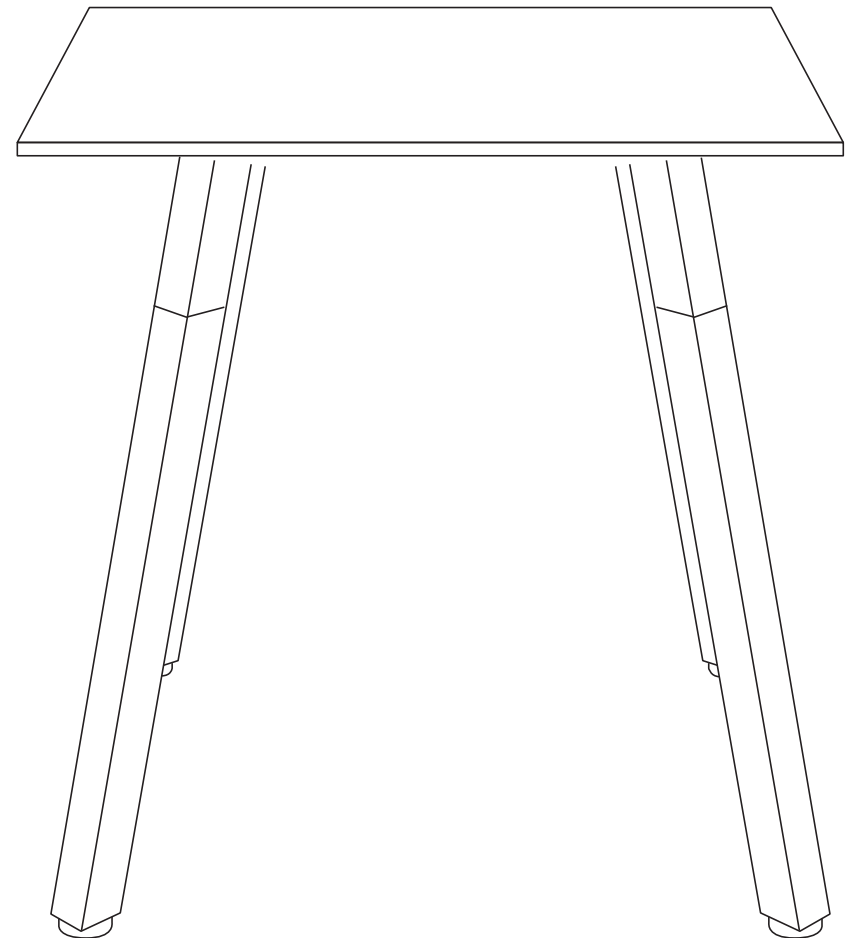
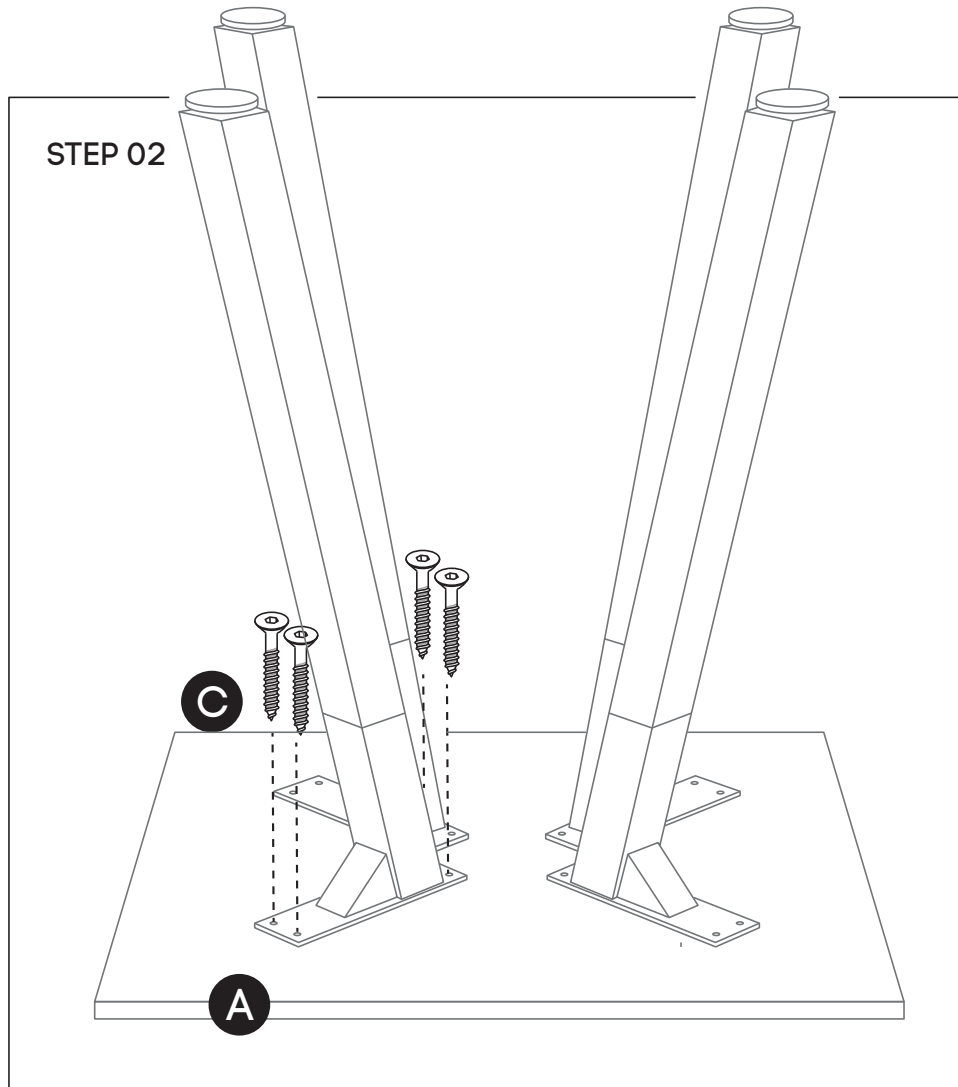

Ask a second person to help turn the table and base over.
Screw the table tops to the bases using woodscrews (C)
through the following holes.

ASSEMBLY INSTRUCTIONS

Quadro Wood CT

Single Legs

www.jasonl.com.au

Need help!

Call us on
1300 527 665

jason.l
your office furniture mate



If you purchased with wheels

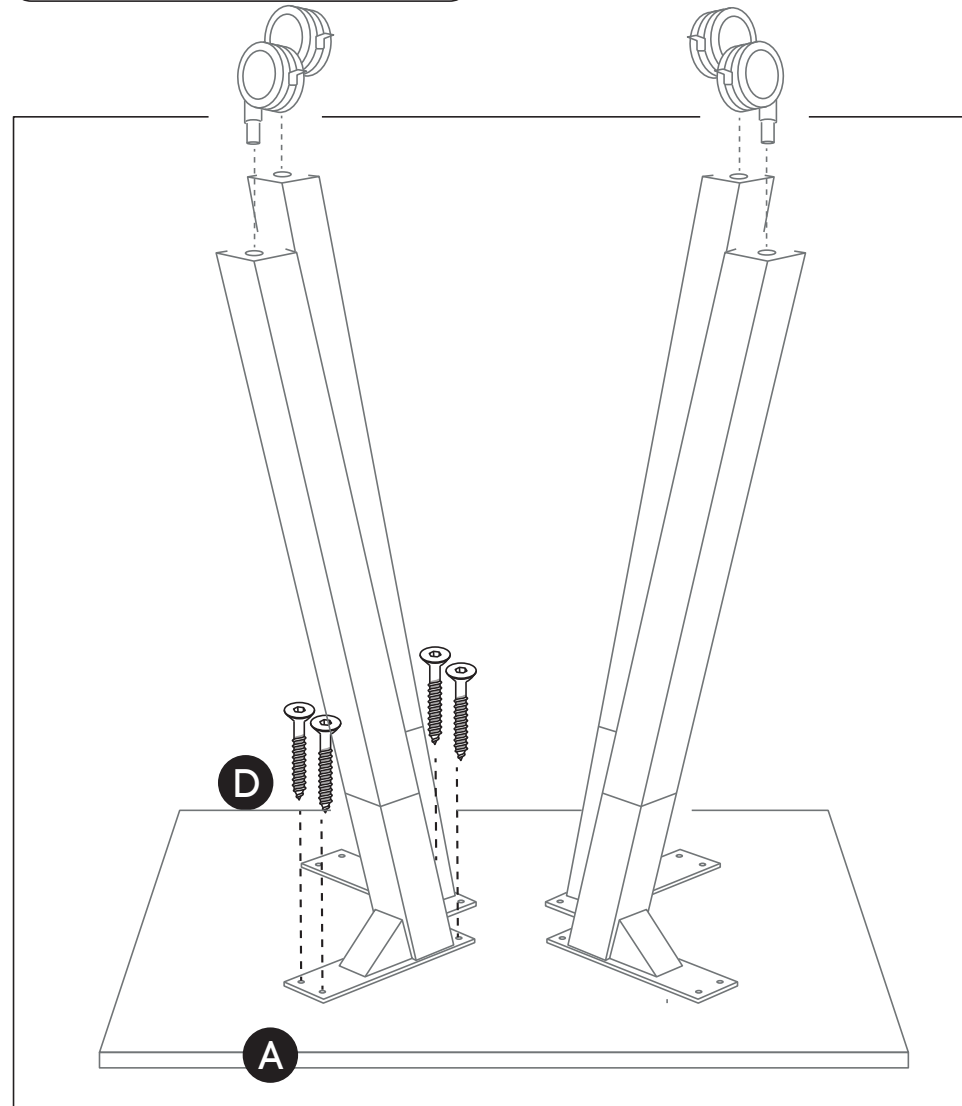
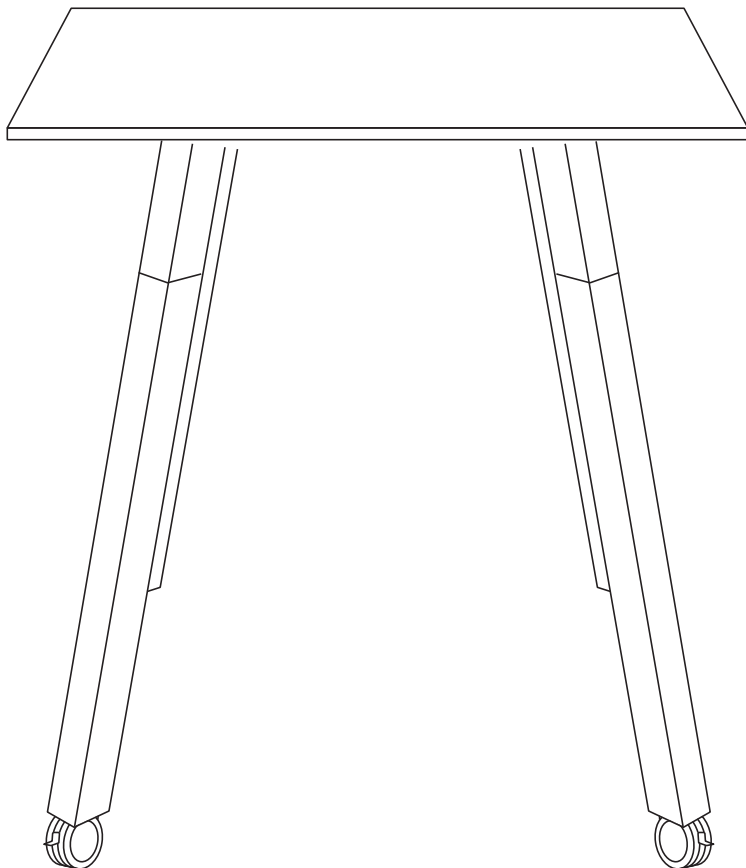

Ask a second person to help turn the table and base over. Screw the table tops to the bases using woodscrews **(D)** through the following holes. Screw the wheels to the bottom of each Leg.