

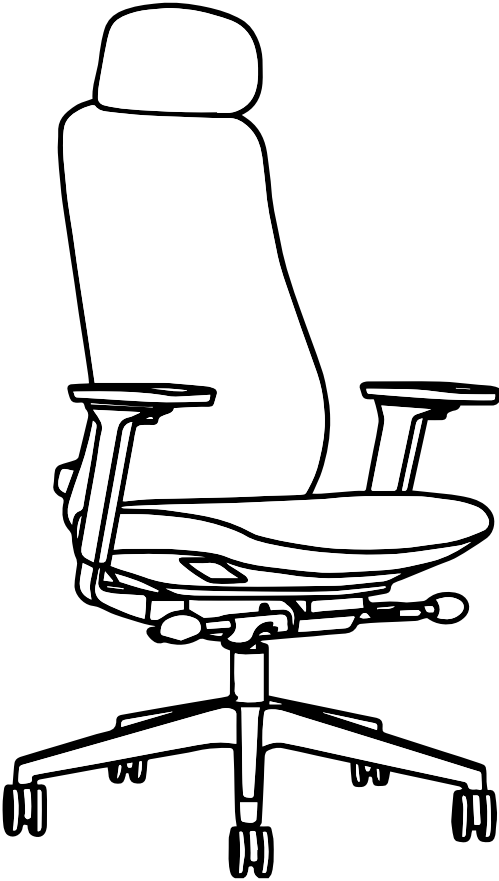















Macaw chair with headrest

jason.l
your office furniture mate



Macaw chair with headrest

Parts

1	2	3	4	5	6	7	8	9	10	11	12	13	14	15
														
							M6x16 mm	M8x17 mm	M8x45 mm	M8x13 mm	M8x50 mm			M5
1pcs	1pcs	5pcs	1pcs	1pcs	1pcs	2pcs	4pcs	7pcs	3pcs	3pcs	2pcs	1pcs	1pcs	1pcs

Assembly instruction

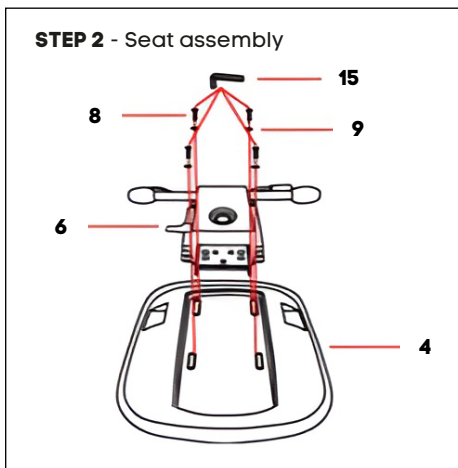
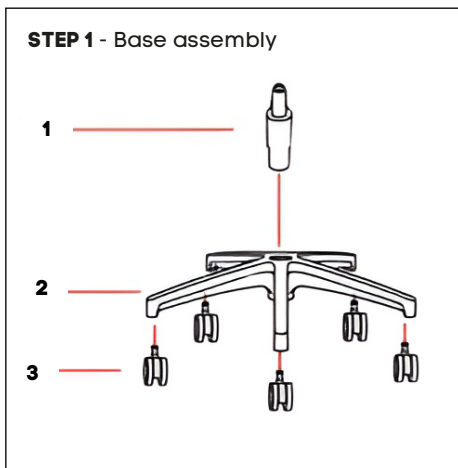

Macaw chair with headrest

STEP 3 - Back assembly

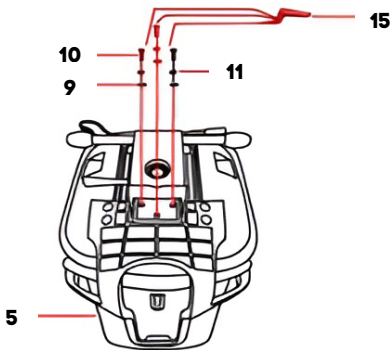

STEP 4 - Adjustable arm assembly

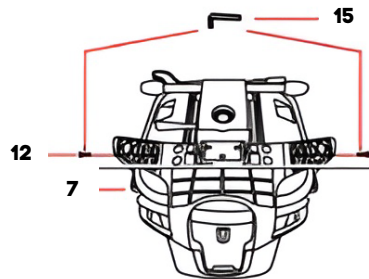

STEP 5 - Join base assembly with seat & back assembly

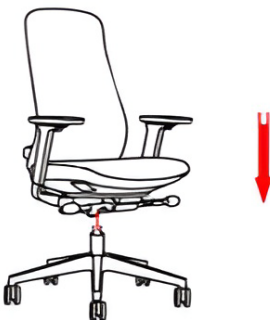

STEP 6 - Headrest assembly

