

ASSEMBLY INSTRUCTIONS
Litewall Workstation
2 Person

Size: 1200mm

www.jasonl.com.au

Need help!
Call us on
1300 527 665

jason.l
your office furniture mate

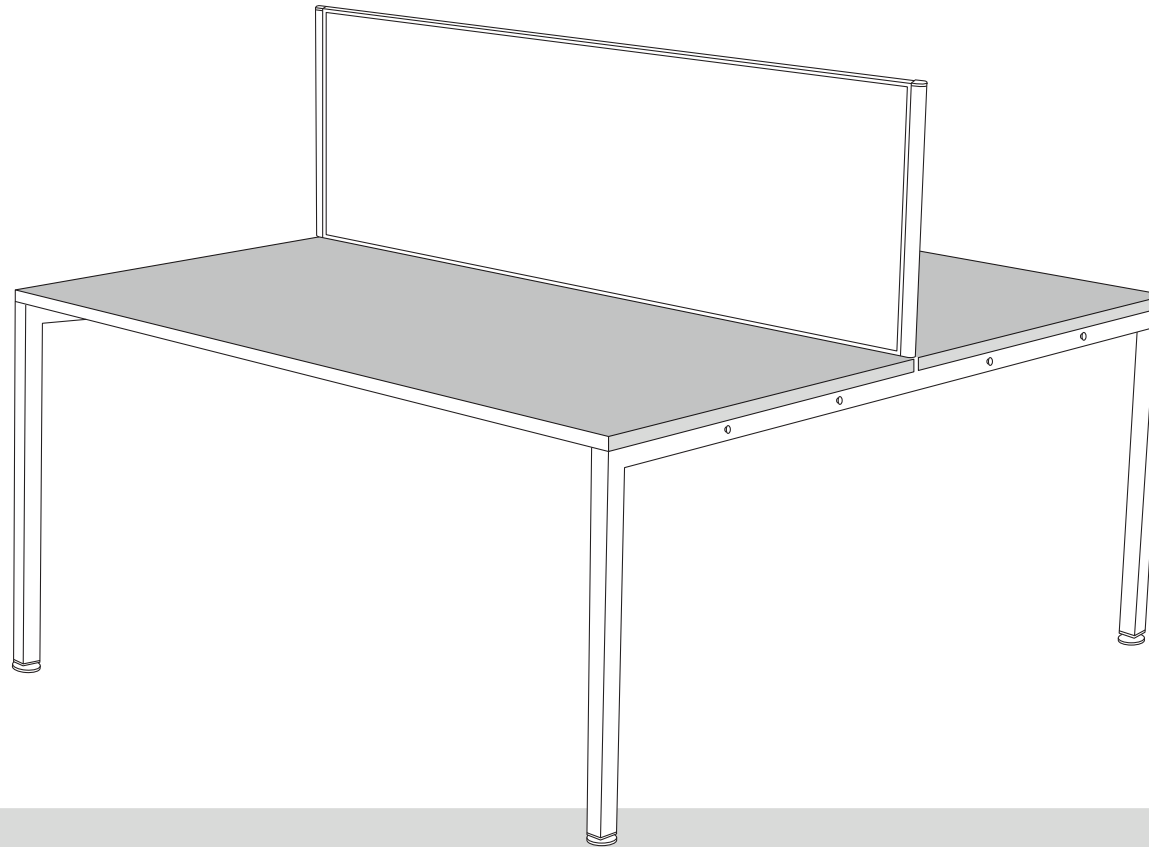

Tools Required: Power screwdriver; Allen key set.

 2 persons required for installation

ASSEMBLY INSTRUCTIONS

Litewall Workstation

2 Person

Size: 1200mm

www.jasonl.com.au

Need help!
Call us on
1300 527 665

jason.l
your office furniture mate

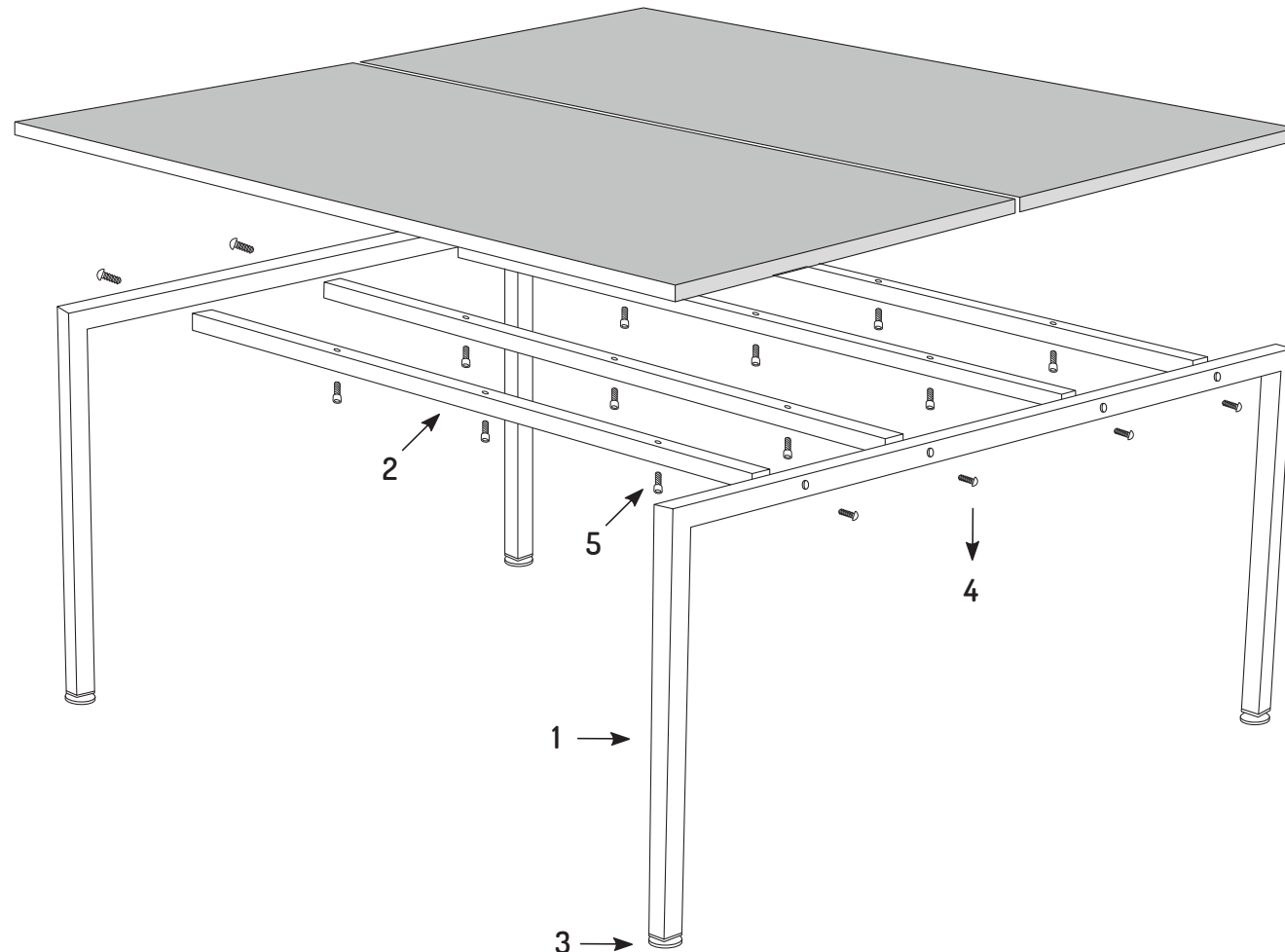

COMPONENTS

- 1 Legs x2 (1625mm)
- 2 Beams x4 (1194mm)
- 3 Feet x4

SCREWS

- 4 M8x25mm Dome Head x8
- 5 M6x40mm Hex Head x12

ASSEMBLY INSTRUCTIONS

Litewall Workstation

2 Person

Size: 1200mm

www.jasonl.com.au

Need help!
Call us on
1300 527 665

jason.l
your office furniture mate

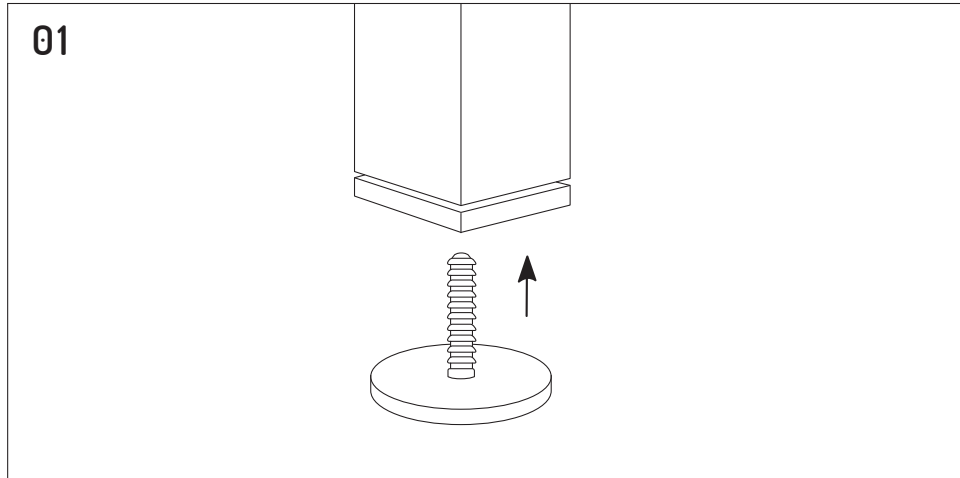

Screw the feet to each leg.

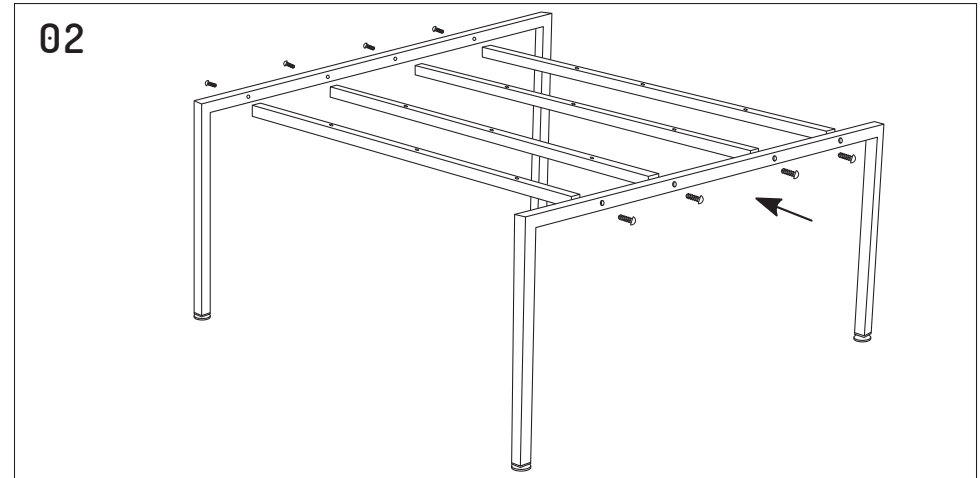

Attach 4x 1194mm beams to 1625mm legs using M8x25mm dome head screw.

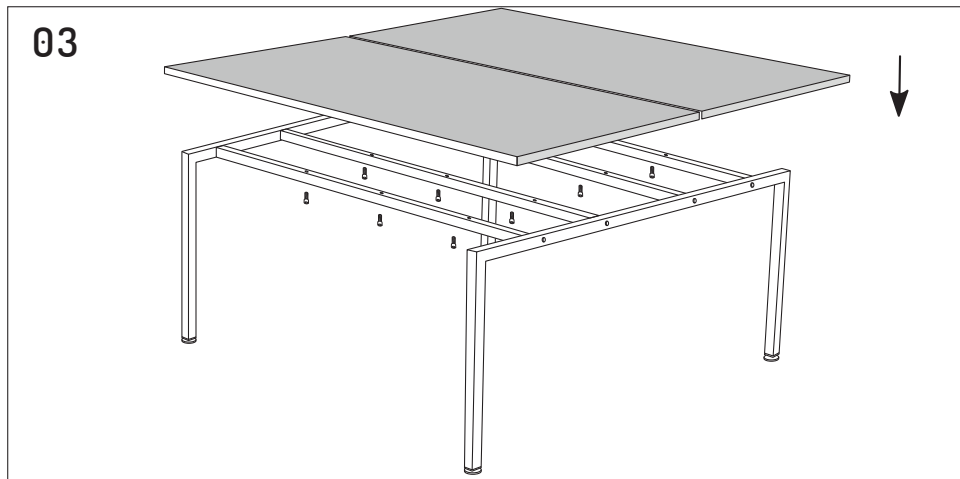

Attach tops to frame by tightening M6x40mm through beams & into tops.

