

Horizon Quadro Square Desk

Sizes:

1200x800

1800x800

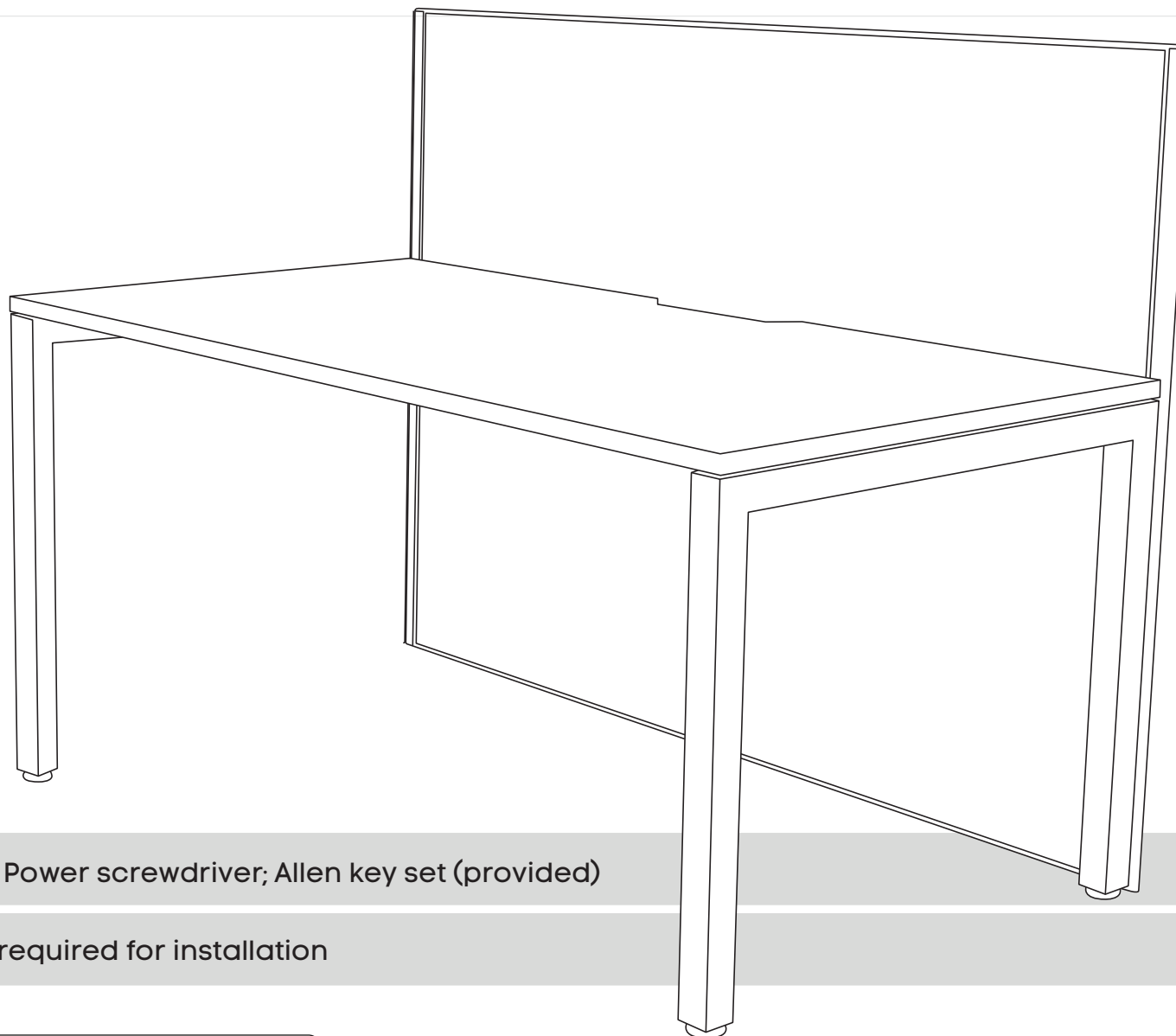

Tools Required: Power screwdriver; Allen key set (provided)

 2 persons required for installation

Need help!

Call us on **1300 527 665**

Horizon Quadro Square Desk

COMPONENTS

- A Table top x1
- B Legs Quadro Square x2
- C Beam x1
- D Plastic bracket x4

SCREWS

- E M8x20MM CSK x2
 - F M8x20MM Socket head x2
 - G M6x20MM Socket head x4
 - H M6x30MM Socket head x4
- I Allen key x2

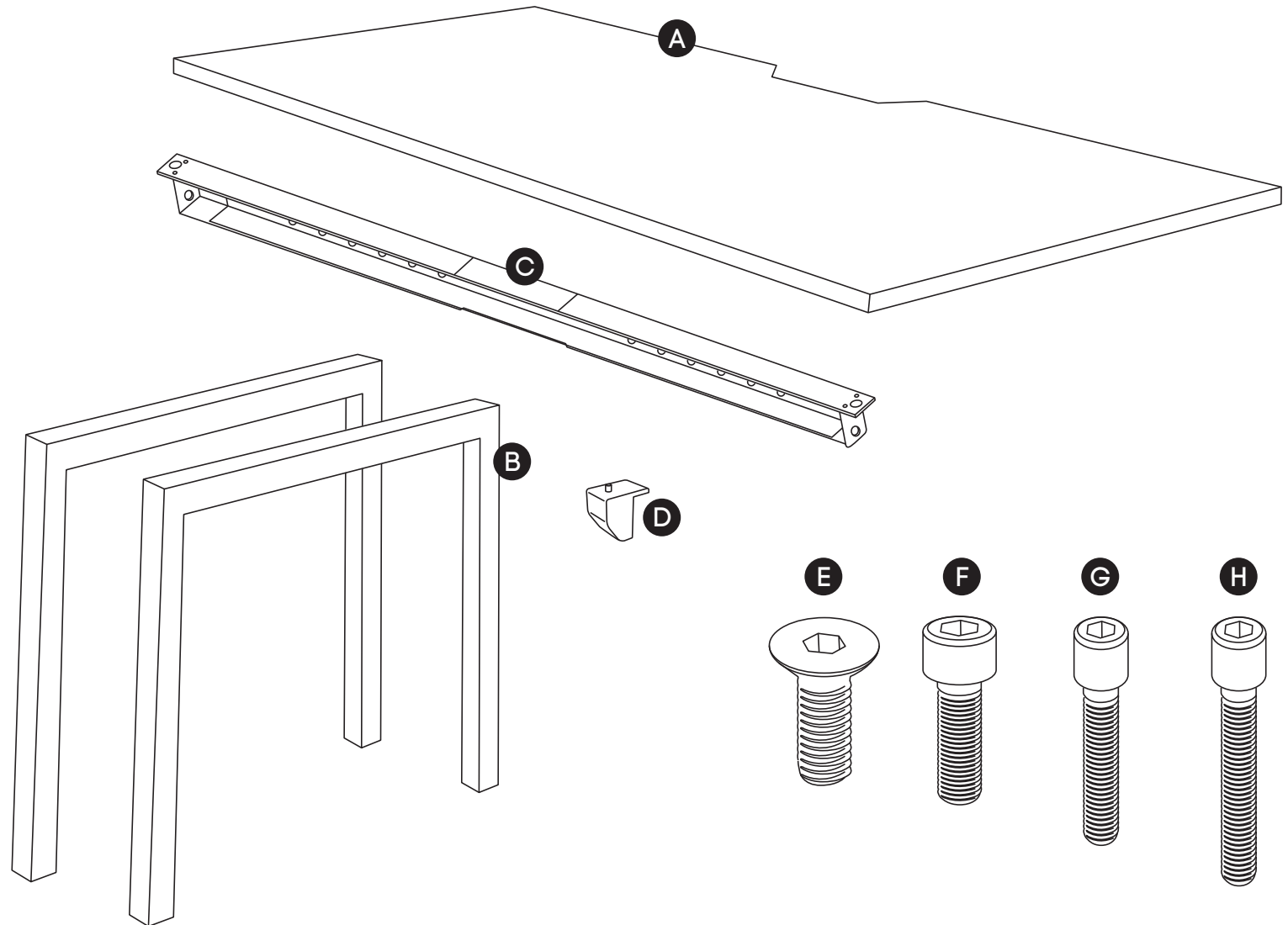

Horizon Quadro Square Desk

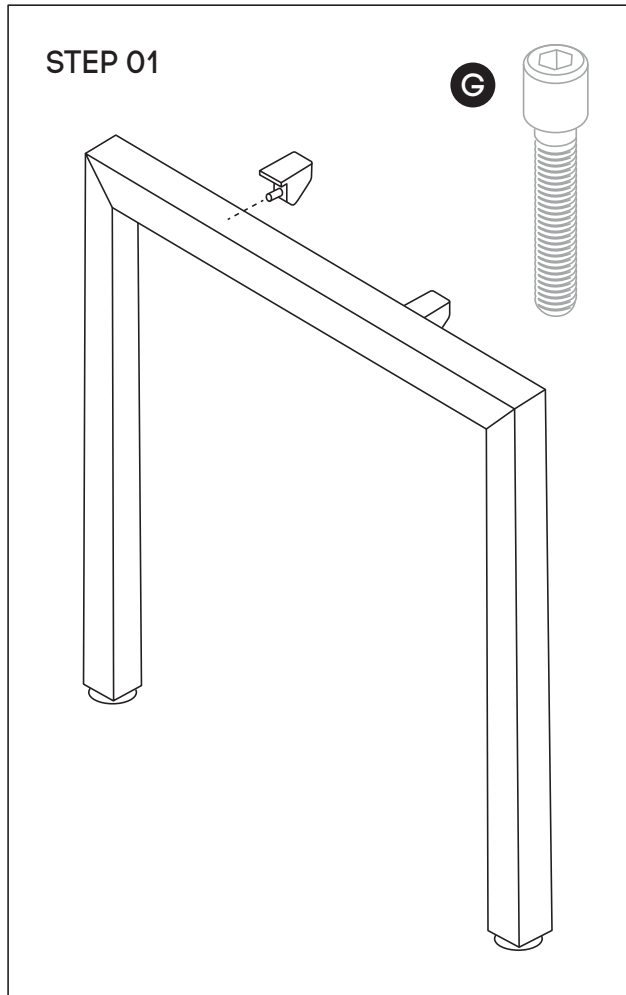

Using Allen Key provided, attach 2 plastic brackets per leg **(D)** (as per picture above) using M6x20MM **(G)** Socket head screw

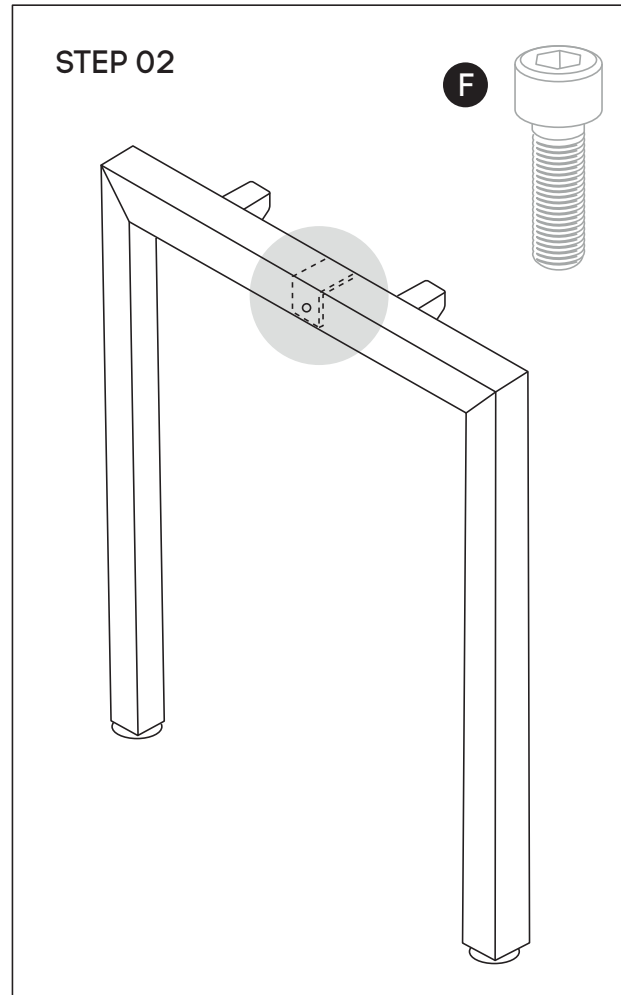

Using Allen Key provided, attach M8x20MM Socket head **(F)**- screw socket half way into leg for both legs **(B)**

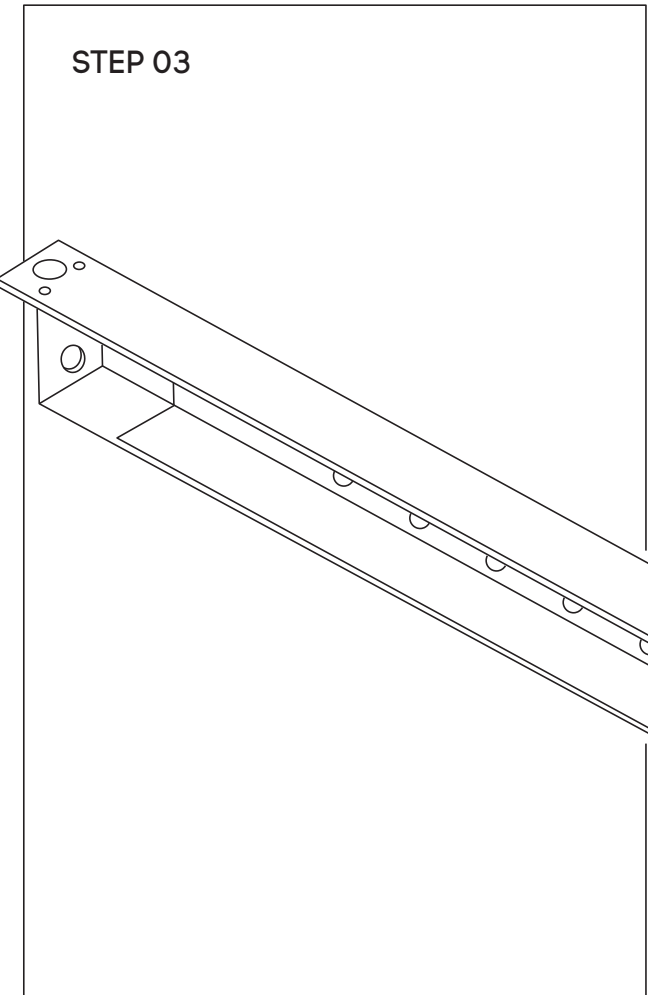

Use fixed beam **(C)** and secure beam using screws provided to fit the desk

Horizon Quadro Square Desk

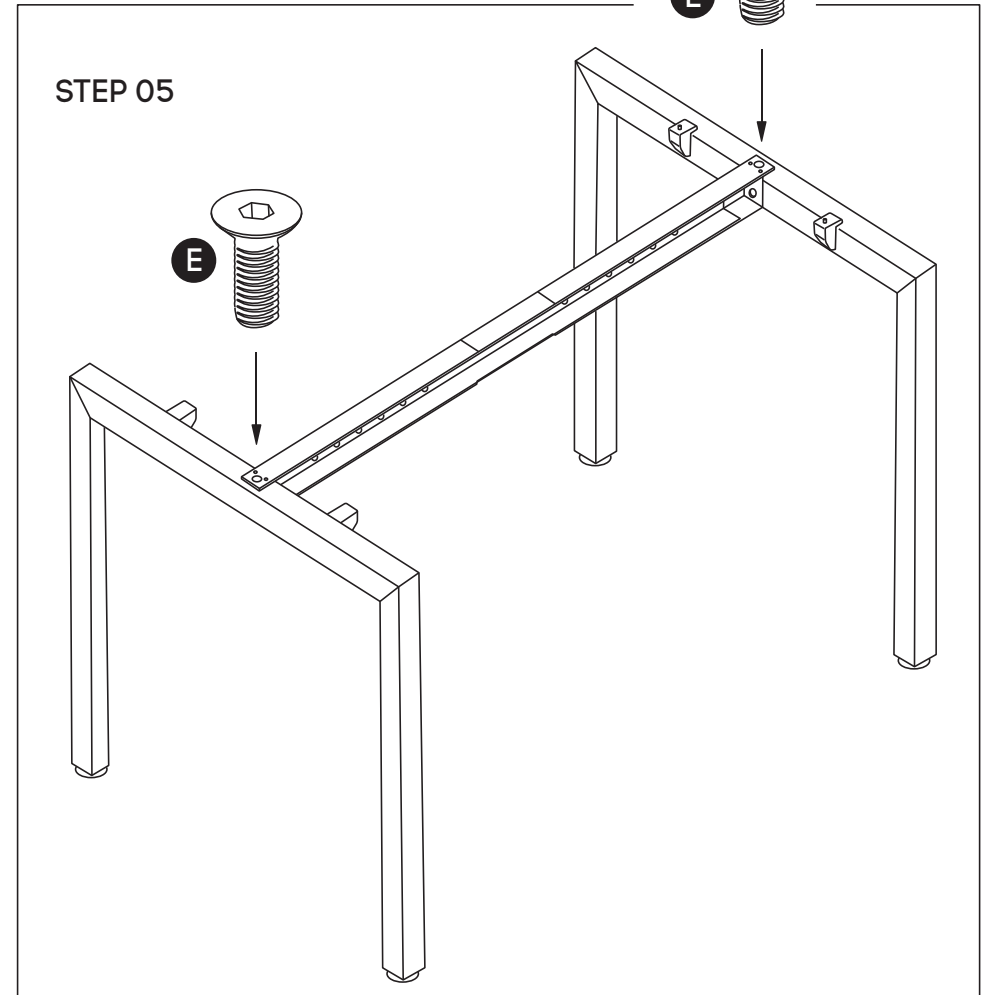
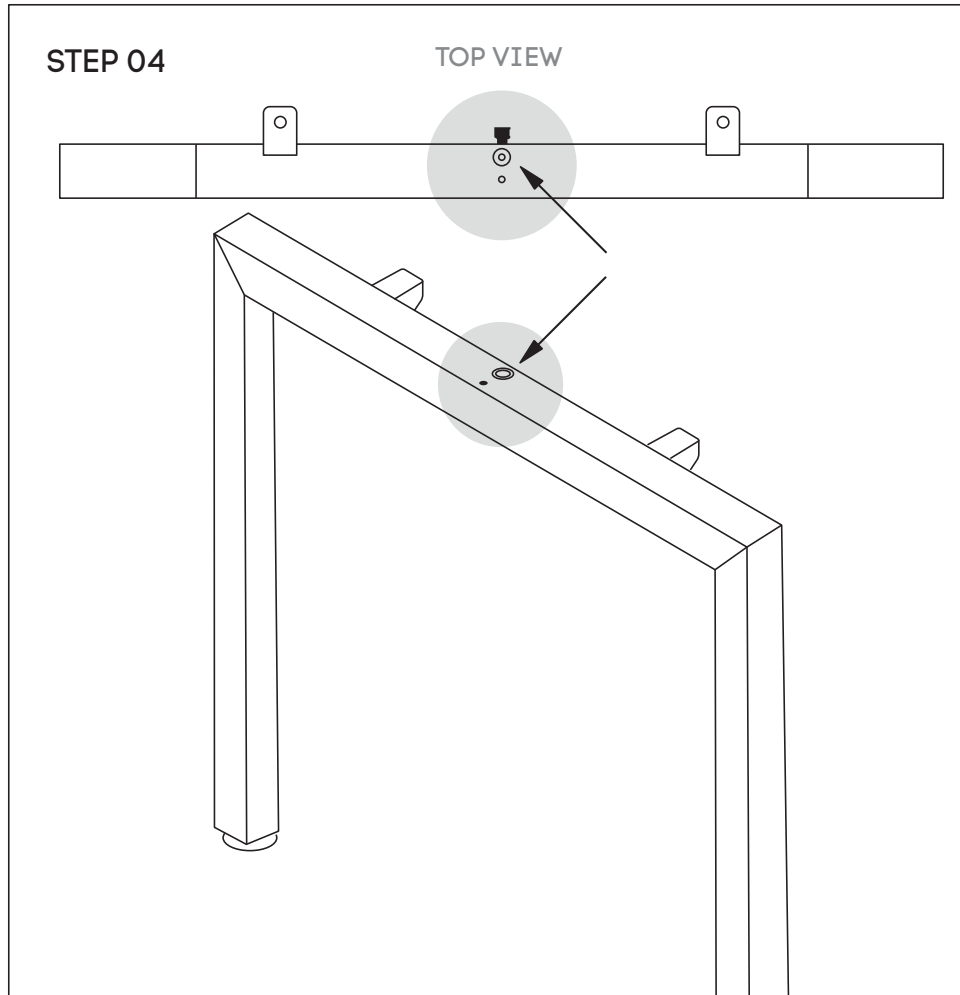

Attach beam (C) to legs (B) using nut insert in legs. See point attached

Frame looks like this. Using Allen Key, attach beam (C) with Socket (E)

Need help! Call us on **1300 527 665**

Horizon Quadro Square Desk

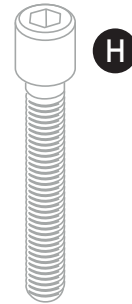
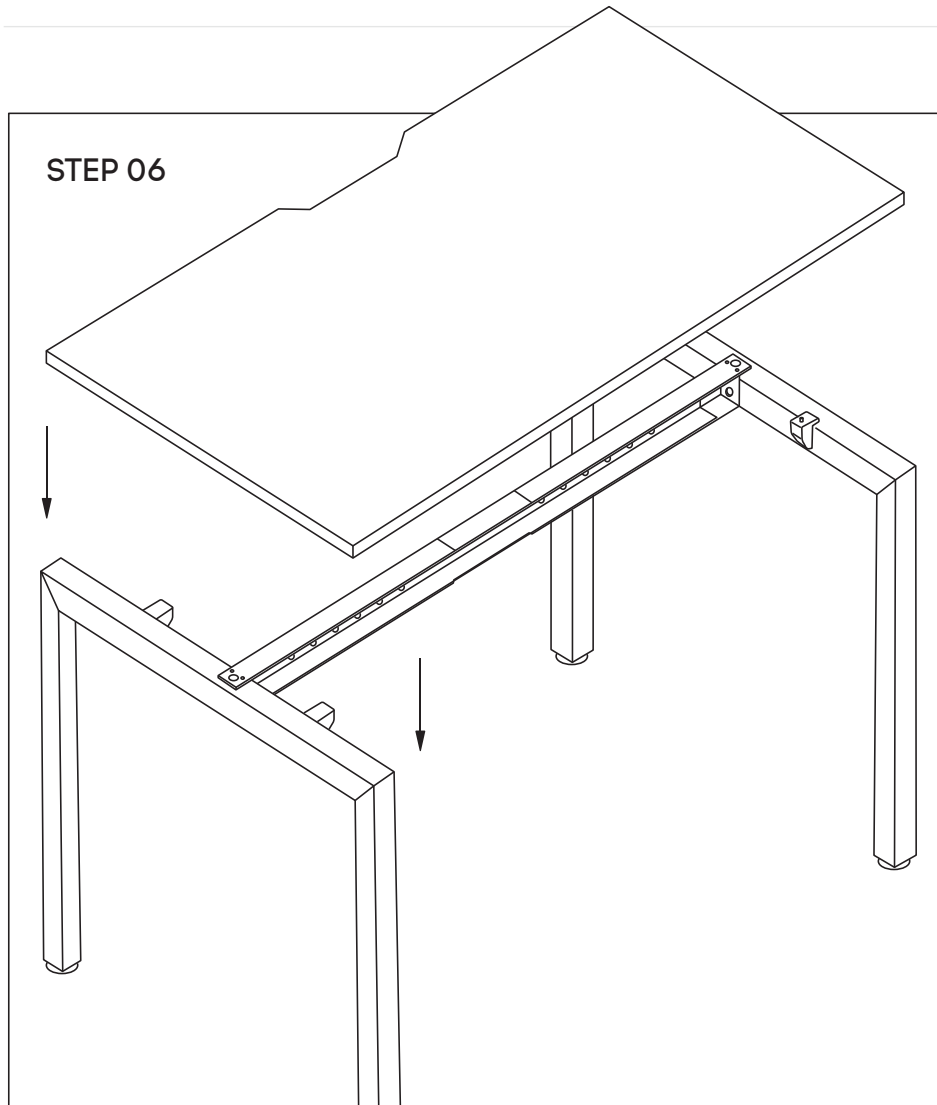

TABLE TOP
BOTTOM VIEW



Place desktop on top of frame. Nut inserts in top will align with plastic joiner brackets using M6x30MM (H) sockets attach top to frame.

Horizon Quadro Square Desk

STEP 07

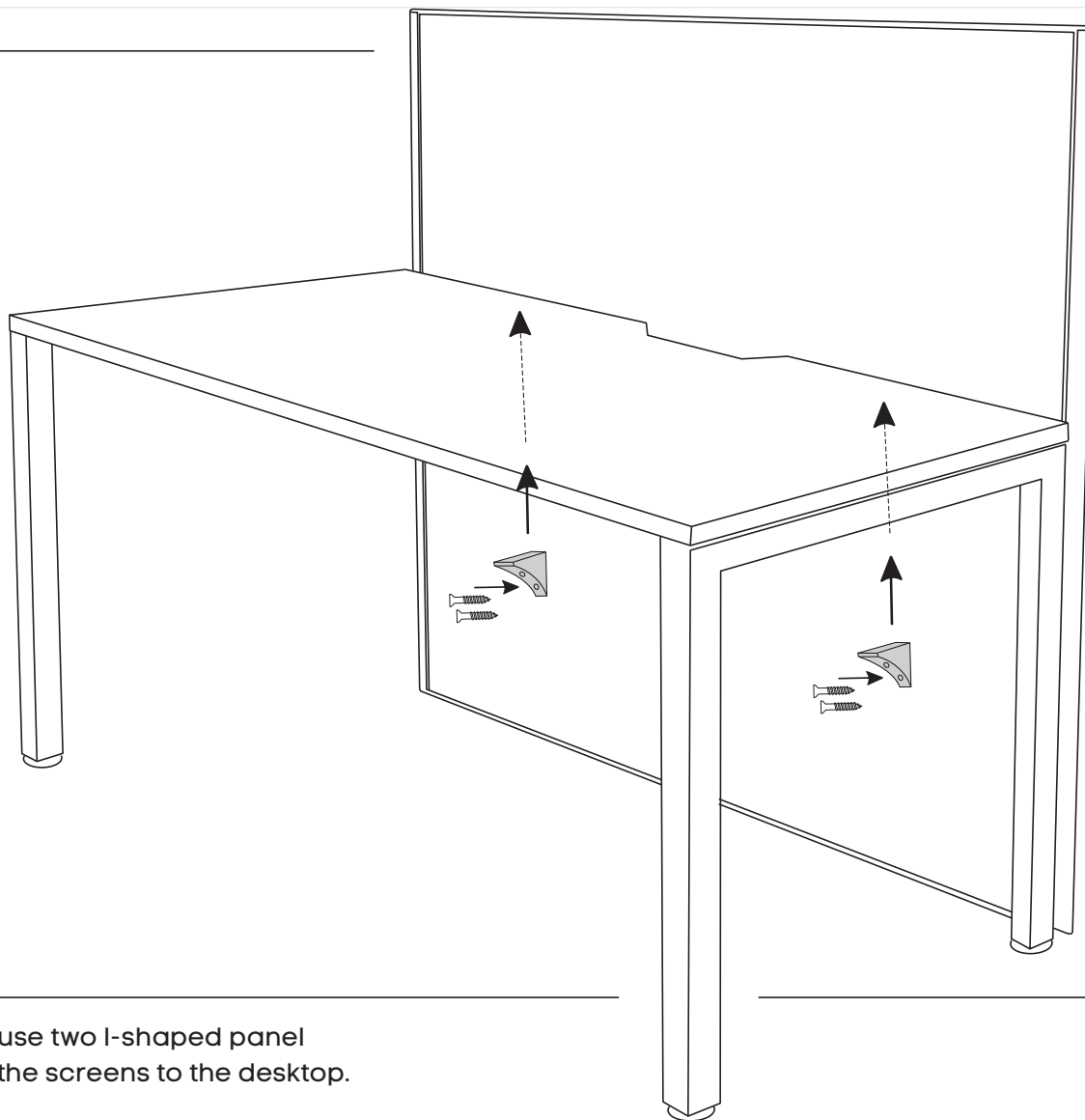

Under the desktop, use two I-shaped panel brackets to secure the screens to the desktop.

Need help!

Call us on **1300 527 665**